

2021

KATALOĞU
CATALOGUE
КАТАЛОГ

konuşulan
the spoken kalite...
quality...

качество говорит
само за себя....



www.akko.com.tr

 **AKKO**®

Kesici Uç ve Bağlama Sistemleri
Cutting Inserts and Connection Systems
Металлорежущий инструмент со сменными пластинами



[/akko.com.tr](http://akko.com.tr)

konusulan
the spoken kalite...
quality...







1986 yılında Abdullah KARAKUŞ tarafından kurulan AKKO Oto. Mak. Hırd. San. Tic. Ltd. Şti. Tornalama Takımları, Diş ve Kanal Açma Takımları, Delik Delme Takımları, Frezeleme Takımları ve Özel Takımları üretmektedir. Şu an 8000 m²' ye yakın bir alanda Türkiye, Japonya, Almanya, İsviçre gibi ülkelerin ürettikleri son teknoloji tezgah ve ekipmanlarıyla yıllık 500.000 adet üretim kapasitesiyle, standart 8000 çeşit takım üretimi yapmaktadır. Avrupa, Asya, Afrika, Güney Amerika ve Orta Doğu'da şimdilik 75 ülkeye ürün sevkiyatına devam etmekte olup 300.000 adet civarında üretilmiş ürün stoklarında mevcuttur. Firmaya, özel üretilen çelik hammadde işleme girer ve bütün üretim süreci bünyesinde gerçekleşir. Çeliğin işlenmesi, ısıl işlemi, üzerindeki kaplama ve her türlü üretim süreci bir entegre tesis olan AKKO'da gerçekleşir.

We as AKKO Oto. Mak. Hırd. San. Tic. Ltd. Şti, which has been founded by Abdullah KARAKUŞ in 1986, produce Turning Tool Holders, Threading and Grooving Tool Holders, U-Drills, Milling Tool Holders and Precision Tool Holders (OEM Tool Holders). We produce standard 8000 kinds of tool holders with production capacity of 500.000 pieces per annum in an area about 8000 square meter. We are going on exporting 75 countries including European, Asian, African, South American Countries and Middle East Countries. We keep ready about 300.000 pieces produced products in our stock. Steel Raw materials that we make produced especially for us are delivered our factory and all production process are made in our factory. All kind of process from machining of steel to heat treatment and coating on our tools are made in our integrated factory AKKO.



AKKO - ведущий производитель резцов, фрез и свёрл со сменными пластинами. Державки и оправки изготовлены для использования унифицированных пластин (ИСО), а также специальных пластин ведущих мировых производителей. Весь инструмент, который производит компания АККО, имеет очень высокое качество и оснащается метизной продукцией Швейцарского производства. Высокое качество продукции обеспечивается современным оборудованием с ЧПУ, высокой культурой производства и использованием высококачественных материалов. Компания основана в 1986 году и находится в Турции, город Конья. Производственная программа: державки токарные, в том числе с хвостовиком из твёрдого сплава; корпуса фрез со сменными пластинами современных конструкций; корпуса свёрл со сменными пластинами. АККО предлагает более 7000 стандартных видов инструментов, ежегодно изготавливая и поставляя клиентам свыше 300 000 изделий. На складе размещено около 300 000 инструментов, что позволяет удовлетворить любой запрос заказчика. Компания экспортирует свою продукцию в 75 стран мира, включая государства Европы, Азии, Африки, Южной Америки и Ближнего Востока.

	KESİCİ UÇLAR ve TAKIMLARI
S11-S14	POLY-V KANAL AÇMA UÇLARI ve TAKIMLARI
S15-S16	KANAL AÇMA, KOŞE BOŞALTMA UÇLARI ve TAKIMLARI
S17-S21	BROŞ ÇEKME UÇLARI ve TAKIMLARI
S22-S25	SUPAP YUVASI İŞLEME UÇLARI ve TAKIMLARI
S26-S29	WHIRLING UÇLARI ve TAKIMLARI

	DIŞ TORNA TAKIMLARI
S33	DIŞ TORNA KATERLERİ KODLAMA SİSTEMİ
S34-S47	T-SİSTEM DIŞ TORNA KATERLERİ
S48-S50	M-SİSTEM DIŞ TORNA KATERLERİ
S51-S62	P-SİSTEM DIŞ TORNA KATERLERİ
S63-S69	C-SİSTEM DIŞ TORNA KATERLERİ
S70-S83	S-SİSTEM DIŞ TORNA KATERLERİ
S83-S87	S-SİSTEM İSVİÇRE TİPİ KAYAR OTOMAT MAKİNA TAKIMLARI
S87-S90	SWISS EASY CHANGE - SEC TOOLS

	DELİK TORNA TAKIMLARI
S92	DELİK TORNA KATERLERİ KODLAMA SİSTEMİ
S93-S98	T&C SİSTEM DELİK TORNA KATERLERİ
S99-S103	M-SİSTEM DELİK TORNA KATERLERİ
S104-S110	P-SİSTEM DELİK TORNA KATERLERİ
S111-S128	S-SİSTEM DELİK TORNA KATERLERİ

	TIRLAMAZ TAKIMLAR-ANTI VIBRATION TOOLS
S130	TIRLAMAZ TAKIMLARIN KODLAMA SİSTEMİ
S131-S136	TIRLAMAZ TAKIMLAR

	KARTUŞLAR
S138	KARTUŞLARIN KODLAMA SİSTEMİ
S139-S141	S-TİP REKTEFİYE KARTUŞLARI
S141-S144	S-SİSTEM KARTUŞLAR
S144-S147	P-SİSTEM KARTUŞLAR VE BORU PAHLAMA TAKIMLARI

	DIŞ AÇMA TAKIMLARI
S149	DIŞ AÇMA KATERLERİ KODLAMA SİSTEMİ
S150-S155	DIŞ AÇMA KATERLERİ ve TEKNİK BİLGİ

	KANAL AÇMA TAKIMLARI
S157	KANAL KATERLERİ KODLAMA SİSTEMİ
S158-S172	DIŞ ÇAP KANAL AÇMA TAKIMLARI
S173-S175	DIŞ ÇAP KANAL AÇMA İSVEÇ TİPİ KAYAR OTOMAT MAKİNA TAKIMLARI
S177-S179	DIŞ ÇAP ALIN KANAL AÇMA TAKIMLARI
S180	L TİP ALIN KANAL AÇMA TAKIMLARI
S180-S182	KESME VE DERİN KANAL AÇMA LAMALARI
S182	KESME VE DERİN KANAL AÇMA LAMA BLOĞU
S184-S186	İÇTEN SOĞUTMA KANALLI KANAL AÇMA TAKIMLARI
S187-S198	DELİK İÇİ KANAL KATERLERİ

	DELİK DELME ve İŞLEME TAKIMLARI
S199-S227	TAKMA UÇLU MATKAPLAR ve KODLAMA SİSTEMİ
S228-S229	DELİK PAHLAMA TAKIMI VE MONTAJ ŞEKLİ
S230	EKSANTRİK TAKMA UÇLU MATKAP ADAPTÖRÜ
S231	ÖZEL DELİK DELME ve İŞLEME TAKIMI SİPARİŞ FORMU
S232-S234	EKONOMİK KESİCİLER ve KODLAMA SİSTEMİ
S235-S240	AYARLI DELİK İŞLEME BARALARI ve KODLAMA SİSTEMİ

	FREZELEME TAKIMLARI
S242	FREZELEME TAKIMLARI KODLAMA SİSTEMİ
S243-S244	S-SİSTEM PAH FREZELER
S244	HELİS PAH FREZELEME TAKIMLARI
S245	SİLİNDİRİK ALYAN BAŞLI VİDA (DIN 974-1) HAVŞALARINI AÇMA FREZELERİ
S246-S271	S-SİSTEM YÜZEY PARMAK FREZELER
S271-S274	S-SİSTEM YÜZEY ve KOPYA PARMAK FREZELER
S274-S285	S-SİSTEM HIZLI İLERLEMELİ PARMAK FREZELER
S285-S295	S-SİSTEM MODÜLER PARMAK FREZELER
S295-S303	S-SİSTEM HIZLI İLERLEMELİ MODÜLER PARMAK FREZELER
S304-S305	KÜRE UÇLU PARMAK FREZELER
S306-S307	MODÜLER KÜRE UÇLU PARMAK FREZELER
S308	VİDALI TAKIM TUTUCULARI
S308-S309	DIŞ AÇMA FREZELEME TAKIMLARI
S310	S-SİSTEM HELİS FREZELER
S312-S346	YÜZEY FREZELER
S347-S350	YÜZEY ve KOPYA FREZELER
S351-S353	C-SİSTEM YÜZEY FREZELER
S354-S361	HIZLI İLERLEMELİ FREZELER
S362-S363	T KANAL FREZELER
S364-S365	DİSK FREZELER
S366-S370	FREZELEME TAKIMLARI MONTAJ ÖLÇÜLERİ ve TEKNİK BİLGİLER

	YEDEK PARÇALAR
S372-S385	YEDEK PARÇALAR
S386-S390	ÜRÜN GURUPLARINA GÖRE İÇİNDEKİLER

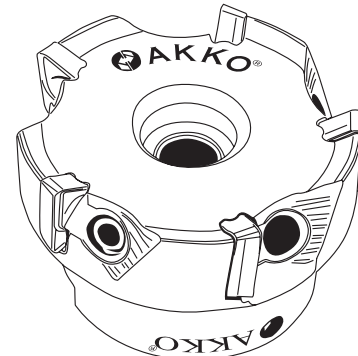
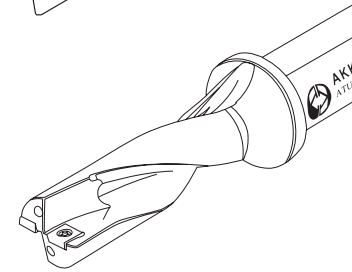
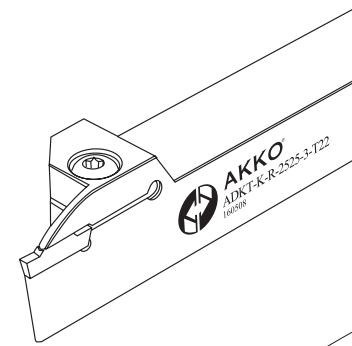
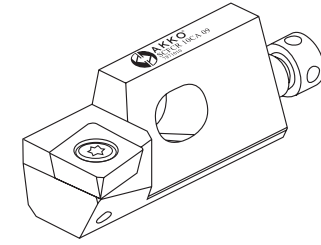
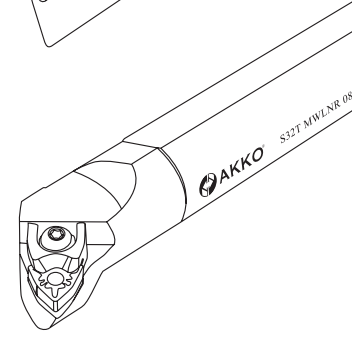
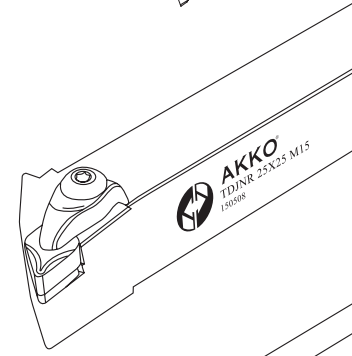
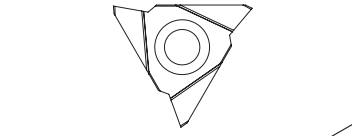

İÇİNDEKİLER

CONTENTS

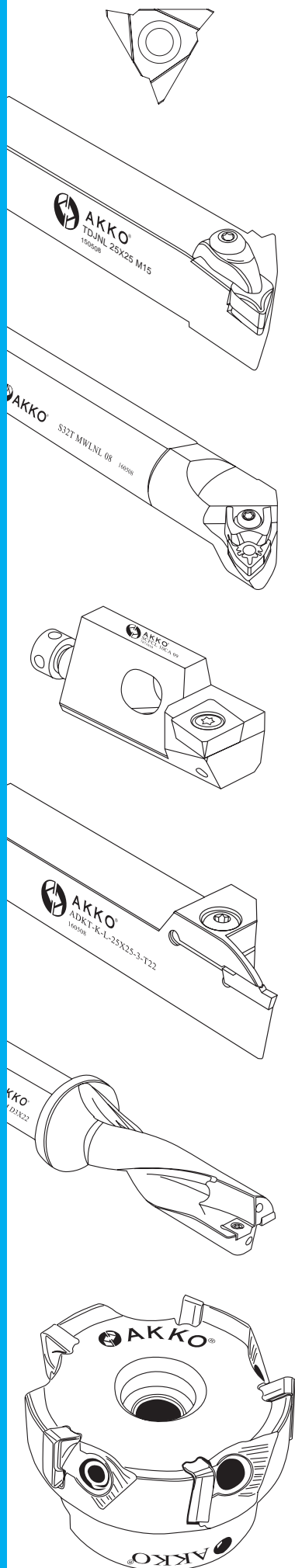

CUTTING INSERTS and TOOLHOLDERS

POLY-V GROOVING INSERTS and TOOLHOLDERS
 INSERTS and TOOLHOLDERS FOR GROOVING CORNER RELIEFS
 BROACHING INSERTS and TOOLHOLDERS
 VALVE SEAT INSERTS and TOOLHOLDERS
 WHIRLING INSERTS and TOOLHOLDERS

P11-P14
 P15-P16
 P17-P21
 P22-P25
 P26-P29

EXTERNAL TURNING TOOLHOLDERS

EXTERNAL TURNING TOOLHOLDERS DESIGNATION SYSTEM
 T-SYSTEM EXTERNAL TURNING TOOLHOLDERS
 M-SYSTEM EXTERNAL TURNING TOOLHOLDERS
 P-SYSTEM EXTERNAL TURNING TOOLHOLDERS
 C-SYSTEM EXTERNAL TURNING TOOLHOLDERS
 S-SYSTEM EXTERNAL TURNING TOOLHOLDERS
 S-SYSTEM TOOLS FOR SWISS TYPE SLIDING AUTOMATIC LATHES
 SEC TOOLS

P33
 P34-P47
 P48-P50
 P51-P62
 P63-P69
 P70-P83
 P83-P87
 P87-P90

INTERNAL TURNING TOOLHOLDERS

BORING BARS DESIGNATION SYSTEM
 T&C SYSTEM BORING BARS
 M-SYSTEM BORING BARS
 P-SYSTEM BORING BARS
 S-SYSTEM BORING BARS

P92
 P93-P98
 P99-P103
 P104-P110
 P111-P128

ANTIVIBRATION TOOLS

ANTIVIBRATION TOOL DESIGNATION SYSTEM
 ANTIVIBRATION TOOLS

P130
 P131-P136

CARTRIDGE

CARTRIDGE DESIGNATION SYSTEM
 S-TYPE ENGINE OVERHAUL CARTRIDGE
 S-SYSTEM CARTRIDGE
 P-SYSTEM CARTRIDGE AND PIPE BEVELING and CHAMFERING TOOLS

P138
 P139-P141
 P141-P144
 P144-P147

THREADING TOOLHOLDERS

THREADING TOOLHOLDERS DESIGNATION SYSTEM
 THREADING TOOLHOLDERS and TECHNICAL INFORMATION

P149
 P150-P155

GROOVING TOOLHOLDERS

GROOVING TOOLHOLDERS DESIGNATION SYSTEM
 EXTERNAL GROOVING TOOLHOLDERS
 EXTERNAL GROOVING TOOLHOLDERS FOR SWISS TYPE SLIDING AUTOMATIC LATHES
 FACE EXTERNAL GROOVING TOOLHOLDERS
 L TYPE FACE EXTERNAL GROOVING TOOLHOLDERS
 BLADES FOR PARTING AND DEEP GROOVING
 BLOCKS FOR PARTING AND DEEP GROOVING BLADES
 EXTERNAL GROOVING TOOLHOLDERS WITH COOLANT HOLE
 INTERNAL GROOVING TOOLHOLDERS

P157
 P158-P172
 P173-P175
 P177-P179
 P180
 P180-P182
 P182
 P184-P186
 P187-P198

DRILLING and HOLEMAKING TOOLS

U-DRILL SYSTEM and DESIGNATION SYSTEM
 DRILL CHAMFERING RING TOOLS and MOUNTING SYSTEM
 EXCENTRIC ADAPTOR FOR U-DRILLS
 SPECIAL DRILL ORDER FORM
 ECONOMIC CUTTING TOOLS and DESIGNATION SYSTEM
 ADJUSTABLE BORING HEADS and DESIGNATION SYSTEM

P199-P227
 P228-P229
 P230
 P231
 P232-P234
 P235-P240

MILLING TOOLS

MILLING TOOLS DESIGNATION SYSTEM
 S-SYSTEM CHAMFERING END MILLS
 HELIX CHAMFER MILLING TOOLS
 COUNTERSINK MILLING TOOL FOR CYLINDRICAL ALLEN HEAD SCREWS (DIN 974-1)
 S-SYSTEM END MILLS
 S-SYSTEM FACE and COPY END MILLS
 S-SYSTEM HIGHFEED END MILLS
 S-SYSTEM MODULAR END MILLS (SCREW TYPE TOOLS)
 S-SYSTEM MODULAR (SCREW TYPE) HIGHFEED END MILLS
 BALL NOSE MILLS
 BALL NOSE MODULAR (SCREW TYPE) END MILLS
 SCREWED TOOL HOLDERS
 THREAD MILLING TOOLS
 S-SYSTEM HELIX END MILL
 FACE MILLING
 FACE and COPY MILLING TOOLS
 C-SYSTEM FACE MILLING
 HIGH FEED MILLING TOOLS
 T SLOT MILLING
 DISC MILLING
 MOUNTING REFERENCE FOR MILLING CUTTERS and TECHNICAL INFORMATION

P242
 P243-P244
 P244
 P245
 P246-P271
 P271-P274
 P274-P285
 P285-P295
 P295-P303
 P304-P305
 P306-P307
 P308
 P308-P309
 P310
 P312-P346
 P347-P350
 P351-P353
 P354-P361
 P362-P363
 P364-P365
 P366-P370

SPARE PARTS

SPARE PARTS
 INDEX

P372-P385
 P386-P390

	РЕЖУЩИЕ ПЛАСТИНЫ и ИНСТРУМЕНТЫ
C11-C14	POLY-V ПЛАСТИНЫ ДЛЯ ОБРАБОТКИ КАНАВОК ПОД КЛИНОВЫЕ РЕМНИ
C15-C16	ПЛАСТИНЫ ДЛЯ ОБРАБОТКИ КАНАВОК
C17-C21	ДОЛБЯКИ С СМП
C22-C25	ИНСТРУМЕНТ ДЛЯ ОБРАБОТКИ СЕДЕЛ КЛАПАНОВ
C26-C29	ИНСТРУМЕНТ ДЛЯ ВИХРЕВОГО РЕЗЬБОФРЕЗЕРОВАНИЯ

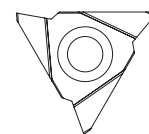

	ДЕРЖАВКИ ДЛЯ НАРУЖНОГО ТОЧЕНИЯ
C33	ОБОЗНАЧЕНИЕ ДЕРЖАВОК ДЛЯ НАРУЖНОГО ТОЧЕНИЯ ПО ISO
C34-C47	T-ТИП ДЕРЖАВКИ ДЛЯ НАРУЖНОГО ТОЧЕНИЯ
C48-C50	M-ТИП ДЕРЖАВКИ ДЛЯ НАРУЖНОГО ТОЧЕНИЯ
C51-C62	P-ТИП ДЕРЖАВКИ ДЛЯ НАРУЖНОГО ТОЧЕНИЯ
C63-C69	C-ТИП ДЕРЖАВКИ ДЛЯ НАРУЖНОГО ТОЧЕНИЯ
C70-C83	S-ТИП ДЕРЖАВКИ ДЛЯ НАРУЖНОГО ТОЧЕНИЯ
C83-C87	S-ТИП ДЕРЖАВКИ ДЛЯ ШВЕЙЦАРСКИХ СТАНКОВ АВТОМАТОВ
C87-C90	ДЕРЖАВКИ ДЛЯ СМЕННЫХ ГОЛОВОК

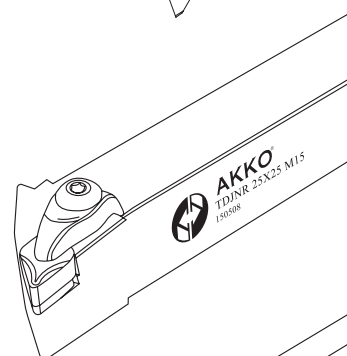

	РАСТОЧНЫЕ ДЕРЖАВКИ
C92	СИСТЕМА ОБОЗНАЧЕНИЯ РАСТОЧНЫХ ДЕРЖАВОК ПО ISO
C93-C98	T И C-ТИП РАСТОЧНЫЕ ДЕРЖАВКИ
C99-C103	M-ТИП РАСТОЧНЫЕ ДЕРЖАВКИ
C104-C110	P-ТИП РАСТОЧНЫЕ ДЕРЖАВКИ
C111-C128	S-ТИП РАСТОЧНЫЕ ДЕРЖАВКИ

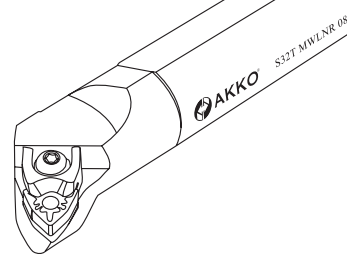

	АНТИВИБРАЦИОННЫЕ ДЕРЖАВКИ
C130	СИСТЕМА ОБОЗНАЧЕНИЙ АНТИВИБРАЦИОННЫХ ДЕРЖАВОК
C131-C136	АНТИВИБРАЦИОННАЯ ДЕРЖАВКА

	КАРТРИДЖИ
C138	СИСТЕМА ОБОЗНАЧЕНИЯ КАРТРИДЖЕЙ
C139-C141	ТИП-S ХОНИНГОВАЛЬНЫЕ КАРТРИДЖИ (ДЛЯ РЕМОНТА ДВС)
C141-C144	S-ТИП КАРТРИДЖИ
C144-C147	P-ТИП КАРТРИДЖИ / ТОРЦОВОЧНАЯ ГОЛОВКА ДЛЯ ЦИЛИНДРИЧЕСКИХ ЗАГОТОВОК

	ДЕРЖАВКИ ДЛЯ НАРЕЗАНИЯ НАРУЖНОЙ РЕЗЬБЫ
C149	СИСТЕМА ОБОЗНАЧЕНИЯ ДЕРЖАВОК ДЛЯ НАРЕЗАНИЯ НАРУЖНОЙ РЕЗЬБЫ
C150-C155	ДЕРЖАВКА ДЛЯ НАРЕЗАНИЯ НАРУЖНОЙ РЕЗЬБЫ / ТЕХНИЧЕСКИЕ РЕКОМЕНДАЦИИ ДЛЯ НАРЕЗАНИЯ РЕЗЬБЫ

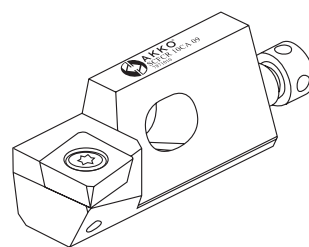

	ДЕРЖАВКИ ДЛЯ ОБРАБОТКИ КАНАВОК
C157	СИСТЕМА ОБОЗНАЧЕНИЯ ДЕРЖАВОК ДЛЯ ОБРАБОТКИ КАНАВОК
C158-C172	ДЕРЖАВКИ ДЛЯ ОБРАБОТКИ НАРУЖНЫХ КАНАВОК
C173-C175	ДЕРЖАВКИ ДЛЯ ОБРАБОТКИ НАРУЖНЫХ КАНАВОК ДЛЯ ТОКАРНЫХ СТАНКОВ ШВЕЙЦАРСКОГО ТИПА
C177-C179	ДЕРЖАВКИ ДЛЯ ОБРАБОТКИ ТОРЦЕВЫХ КАНАВОК
C180	ДЕРЖАВКИ L-ТИПА ДЛЯ ОБРАБОТКИ ТОРЦЕВЫХ КАНАВОК
C180-C182	НОЖИ ДЛЯ ОТРЕЗКИ И ОБРАБОТКИ ГЛУБОКИХ КАНАВОК
C182	БЛОКИ К СМЕННЫМ НОЖАМ ДЛЯ ОТРЕЗКИ И ОБРАБОТКИ ГЛУБОКИХ КАНАВОК
C184-C186	ДЕРЖАВКИ ДЛЯ ОБРАБОТКИ НАРУЖНЫХ КАНАВОК С ПОДВОДОМ СОЖ
C187-C198	ДЕРЖАВКИ ДЛЯ ОБРАБОТКИ ВНУТРЕННИХ КАНАВОК

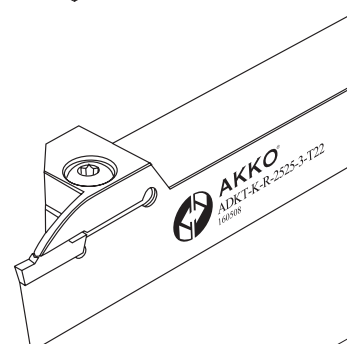

	ИНСТРУМЕНТ ДЛЯ СВЕРЛЕНИЯ И ОБРАБОТКИ ОТВЕРСТИЙ
C199-C227	СВЕРЛА /СИСТЕМА ОБОЗНАЧЕНИЯ СВЕРЕЛ
C228-C229	КОЛЬЦА ДЛЯ СНЯТИЯ ФАСКИ / ЭКСЦЕНТРИЧЕСКИЙ АДАПТЕР ДЛЯ СВЕРЕЛ
C230	ЭКСЦЕНТРИЧЕСКИЙ АДАПТЕР ДЛЯ СВЕРЕЛ
C231	ФОРМА ДЛЯ ЗАКАЗА СПЕЦИАЛЬНЫХ СВЕРЕЛ
C232-C234	МНОГОФУНКЦИОНАЛЬНЫЙ MULTI TOOL / СИСТЕМА ОБОЗНАЧЕНИЯ MULTI TOOL
C235-C240	РЕГУЛИРУЕМЫЕ РАСТОЧНЫЕ ГОЛОВКИ / СИСТЕМА ОБОЗНАЧЕНИЙ РЕГУЛИРУЕМЫХ РАСТОЧНЫХ ГОЛОВОК

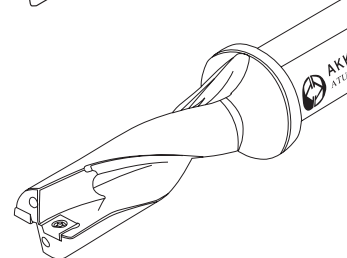

	ФРЕЗЕРНЫЙ ИНСТРУМЕНТ
C242	СИСТЕМА ОБОЗНАЧЕНИЙ ФРЕЗЕРНОГО ИНСТРУМЕНТА
C243-C244	S-ТИП КОНЦЕВЫЕ ФРЕЗЫ ДЛЯ СНЯТИЯ ФАСКИ (ЗЕНКОВКИ)
C244	КУКУРУЗНЫЕ ФРЕЗЫ ДЛЯ СНЯТИЯ ФАСКИ
C245	ЗЕНКОВКА ДЛЯ ОТВЕРСТИЙ ПОД ВИНТЫ С ЦИЛИНДРИЧЕСКОЙ И ШЕСТИГРАННОЙ ГОЛОВКОЙ (DIN 974-1)
C246-C271	S-ТИП КОНЦЕВЫЕ ФРЕЗЫ
C271-C274	S-ТИП КОНЦЕВЫЕ РАДИУСНЫЕ ФРЕЗЫ
C274-C285	S-ТИП ВЫСОКОПРОИЗВОДИТЕЛЬНЫЕ КОНЦЕВЫЕ ФРЕЗЫ
C285-C295	S-ТИП СМЕННЫЕ ФРЕЗЕРНЫЕ ГОЛОВКИ (КРЕПЛЕНИЕ ПОД РЕЗЬБУ)
C295-C303	S-ТИП СМЕННЫЕ ФРЕЗЕРНЫЕ ГОЛОВКИ (КРЕПЛЕНИЕ ПОД РЕЗЬБУ)
C304-C305	СФЕРИЧЕСКИЕ КОНЦЕВЫЕ ФРЕЗЫ
C306-C307	S-ТИП СМЕННЫЕ СФЕРИЧЕСКИЕ ФРЕЗЕРНЫЕ ГОЛОВКИ (КРЕПЛЕНИЕ ПОД РЕЗЬБУ)
C308	ОПРАВКИ ДЛЯ СМЕННЫХ ГОЛОВОК
C308-C309	РЕЗЬБОНАРЕЗНЫЕ ФРЕЗЫ
C310	S-ТИП СПИРАЛЬНАЯ КОНЦЕВАЯ ФРЕЗА (КУКУРУЗНАЯ ФРЕЗА)
C312-C346	ТОРЦЕВЫЕ ФРЕЗЫ
C347-C350	ТОРЦЕВЫЕ И КОПИРОВАЛЬНЫЕ ФРЕЗЫ
C351-C353	C-ТИП ТОРЦЕВЫЕ ФРЕЗЫ
C354-C361	ВЫСОКОПРОИЗВОДИТЕЛЬНЫЕ ТОРЦЕВЫЕ ФРЕЗЫ
C362-C363	T-ОБРАЗНЫЕ ФРЕЗЫ
C364-C365	ДИСКОВЫЕ ТРЕХСТОРОННИЕ ФРЕЗЫ
C366-C370	ИНСТРУКЦИЯ ПО УСТАНОВКЕ ФРЕЗ И ТЕХНИЧЕСКАЯ ИНФОРМАЦИЯ

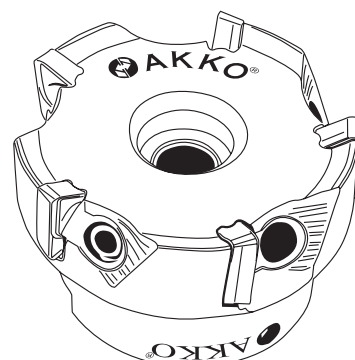

	ЗАПАСТНЫЕ ЧАСТИ
C372-C385	ЗАПАСТНЫЕ ЧАСТИ
C386-C390	СОДЕРЖАНИЕ

***konusulan**
the spoken kalite...
quality...*





KESİCİ UÇLAR ve TAKIMLARI

CUTTING INSERTS and TOOLHOLDERS

РЕЖУЩИЕ ПЛАСТИНЫ И ДЕРЖАВКИ К НИМ

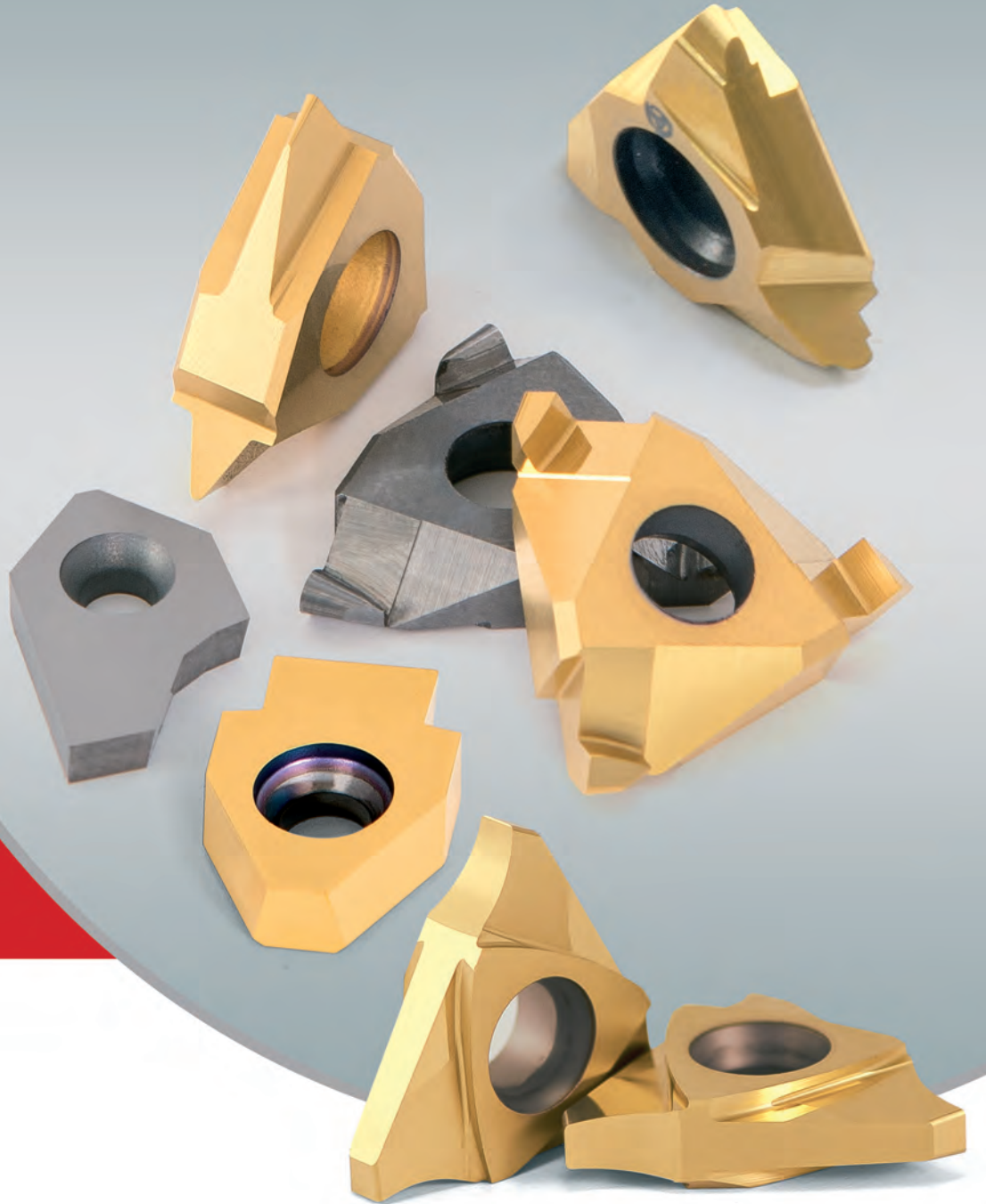

POLY-V

POLY-V KANAL AÇMA UÇLARI ve TAKIMLARI
POLY-V GROOVING INSERTS and TOOLHOLDERS
POLY-V ПЛАСТИНЫ ДЛЯ ОБРАБОТКИ КАНАВОК ПОД
КЛИНОВЫЕ РЕМНИ И ДЕРЖАВКИ ПОД НИХ

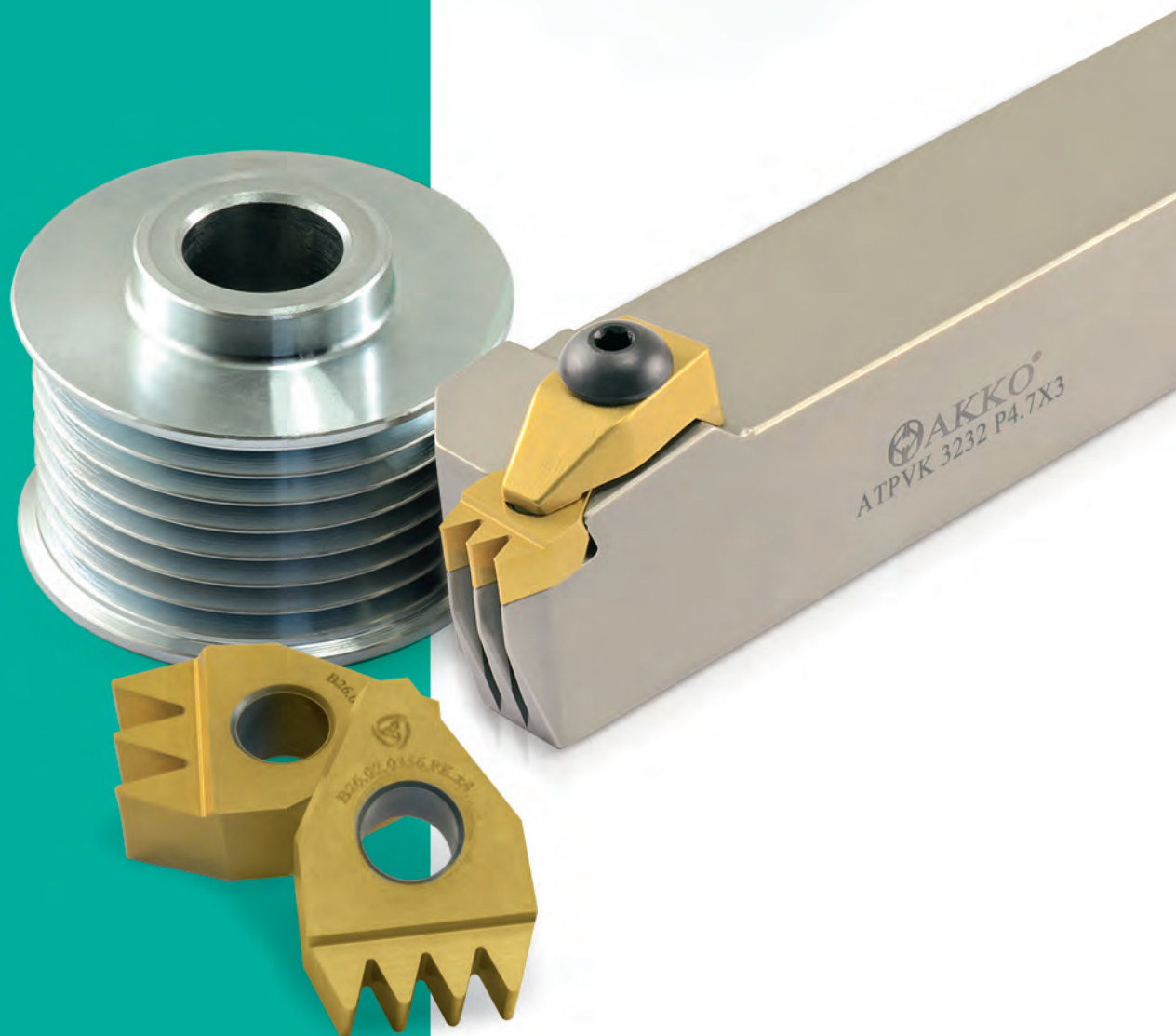

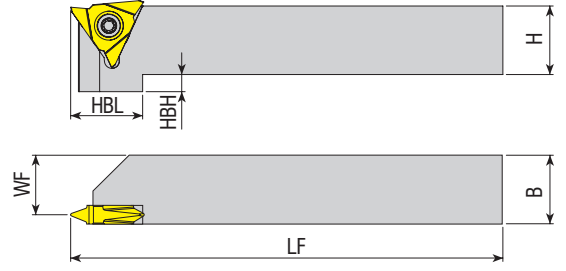

Takım Kodu Ordering Code Код для заказа	Stok Stock Наличие		Takım Ölçüleri (mm) Dimension (mm) Размеры (мм)					Kesici Uç Insert Пластина	Yedek Parçaları / Spare Parts / Запасные части		
	R	L	H	B	WF	LF	HBL		HBH	Sıkma Vidası Screw Зажимной винт	Tork Anahtar Torx Key Торх Ключ
ADKT-T12P-R/L-1616-T5	●	●	16	16	13.50	125	21	5			
ADKT-T12P-R/L-2020-T5	●	●	20	20	17.50	125	21	5			
ADKT-T12P-R/L-2525-T5	●	●	25	25	22.50	150	-	-			
ADKT-T12P-R/L-3232-T5	●	●	32	32	29.50	170	-	-			

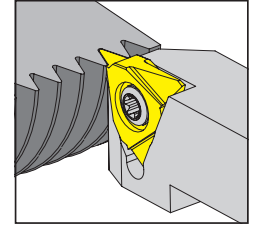
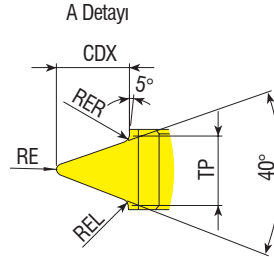
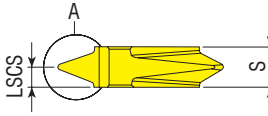
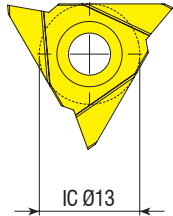
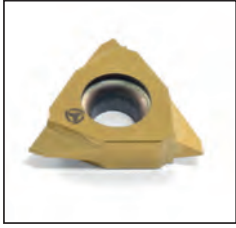

Uç Kodu Insert Code Код Пластина	Stok Stock Наличие		Uç Ölçüleri (mm) Insert Dimension (mm) Размеры (мм)						Kalite Grade Марка твердого сплава
	R	L	TP	S	RE	RER / REL	LSCS	CDX	
T12.10.0234.PJ.R	●	●	2.34	5.20	0.36	0.24	2.60	2.08	VK20F01
T12.10.0356.PK.R	●	●	3.56	5.20	0.44	0.35	2.60	3.40	VK20F01
T12.10.0470.PL.R	●	●	4.70	5.20	0.36	0.45	2.60	4.90	VK20F01

R: Sağ / Right / Правый L: Sol / Left / Левый

● Stokta / In Stock / В наличии ○ Stokta Yok / Non Stock Item / Нет в наличии

ADKT-T12P..Tipi katerler ile kullanınız. / Use with ADKT-T12P.. Type toolholder. / Используйте резцы Тип ADKT-T12P

İndekslediğinde boy $\pm 0,02$ mm / Indexability length $\pm 0,02$ mm / Индексруемая длина $\pm 0,02$ мм

Diğer ölçü talepleriniz için müşteri temsilciniz ile irtibata geçiniz. / For other dimension request, contact with customer representative.

Для запроса другого размера, свяжитесь с работником компании

Sipariş Örneği/Ordering Example/Образец заказа

1 ad./pcs./шт. ADKT-T12P-R-1616-T5

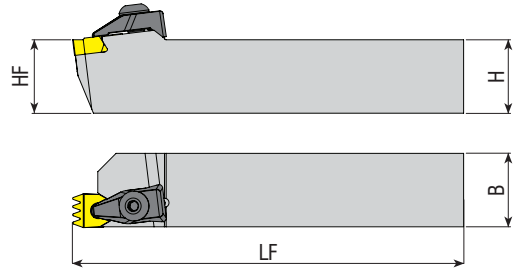

Takım Kodu Ordering Code Код для заказа	Stok Stock Наличие		Takım Ölçüleri (mm) Dimension (mm) Размеры (мм)			Kesici Uç Insert Пластина	Yedek Parçaları / Spare Parts / Запасные части		
	R	L	HF=H	B	LF		Baskı Pabucu Wedge Clamp Прижим	Pabuç Vidası Clamp Screw Зажимной винт	Anahtar Allen Key Ключ
ATPVK 2020 K2.34X4	○	○	20	20	125	B26.07.0234PJ.x4			
ATPVK 2525 M2.34X4	○	○	25	25	150				
ATPVK 3232 P2.34X4	●	○	32	32	170				
ATPVK 2020 K3.56X4	○	○	20	20	125				
ATPVK 2525 M3.56X4	○	○	25	25	150	B26.07.0356PK.x4	ATK-04	AKV-19-M7X25	AAL-05-4
ATPVK 3232 P3.56X4	●	○	32	32	170				
ATPVK 2020 K4.7X3	○	○	20	20	125	B26.07.0470PL.x3			
ATPVK 2525 M4.7X3	○	○	25	25	150				
ATPVK 3232 P4.7X3	●	○	32	32	170				

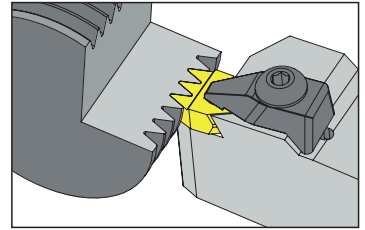
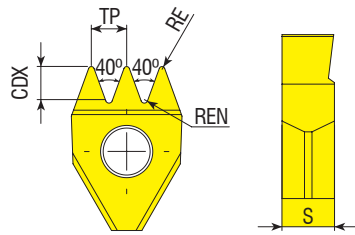

Uç Kodu Insert Code Код Пластина	Stok Stock Наличие	Uç Ölçüleri (mm) Insert Dimension (mm) Размеры (мм)					Kalite Grade Марка твердого сплава
		TP	S	RE	REN	CDX	
B26.07.0234.PJx4	●	2.34	7	0.36	0.24	2.08	VK10F01
B26.07.0356.PKx4	●	3.56	7	0.45	0.35	3.35	VK10F01
B26.07.0470.PLx3	●	4.70	7	0.38	0.45	4.85	VK10F01

R: Sağ / Right / Правый L: Sol / Left / Левый
● Stokta / In Stock / В наличии ○ Stokta Yok / Non Stock Item / Нет в наличии

Sipariş Örneği/Ordering Example/Образец заказа
1 ad./pcs./шт. ATPVK 2020 K2.34X4

konusulan
the spoken kalite...
quality...



KANAL AÇMA

KANAL AÇMA, KÖŞE BOŞALTMA UÇLARI ve TAKIMLARI
INSERTS and TOOLHOLDERS FOR GROOVING CORNER RELIEFS
ПЛАСТИНЫ ДЛЯ ОБРАБОТКИ КАНАВОК



AKKO®
AAUT-T20-R-25



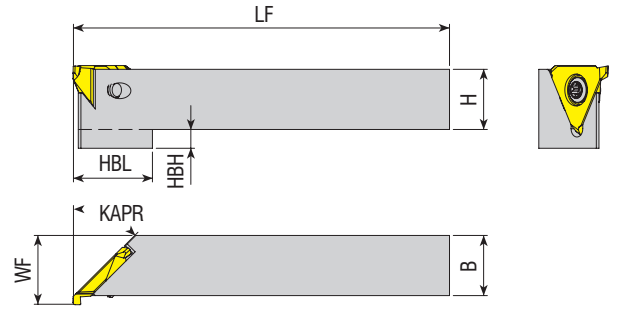

Takım Kodu Ordering Code Код для заказа	Stok Stock Наличие		Takım Ölçüleri (mm) Dimension (mm) Размеры (мм)						Kesici Uç Insert Пластина	Sıkma Vidası Screw Зажимной винт	Tork Anahtar Torx Key Торх Ключ	
	R	L	H	B	WF	LF	HBL	HBH				KAPR
AAUT-T20-R/L-1616-45	●	●	16	16	18.3	125	21	5	45°	T20...	1020-M5x7.5	80-T20
AAUT-T20-R/L-2020-45	●	●	20	20	22.3	125	21	5	45°			
AAUT-T20-R/L-2525-45	●	●	25	25	27.3	150	-	-	45°			

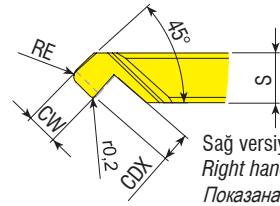
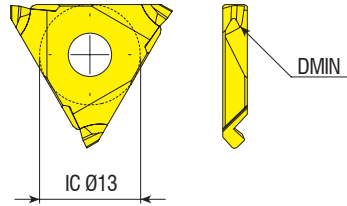
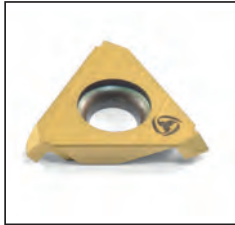

Sağ versiyon gösterilmiştir
 Right hand version shown
 Показана правая версия

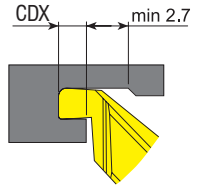

Uç Kodu Insert Code Код Пластина	Stok Stock Наличие		Uç Ölçüleri (mm) Insert Dimension (mm) Размеры (мм)				Kalite Grade Марка твердого сплава	Minimum Çap Ø Minimum Diameter Ø Минимум Диаметр Ø	Kanal Derinliği Depth of Groove Up to Глубина канавки	Kanal Genişliği Width of Groove Ширина канавки	
	R	L	CW	S	RE	CDX					DMIN
T20.00.0815.45.04R/L	●	●	1.5	3.25	0.4	1.6	8	VK20F01	8	1.6	1.5
T20.00.1220.45.05R/L	●	●	2.0	3.25	0.5	1.8	12	VK20F01	12	1.8	2.0
T20.00.2024.45.06R/L	●	●	2.4	3.25	0.6	2.0	20	VK20F01	20	2.0	2.4

AAUT.. Tipi katerlerle kullanınız. / Use with AAUT type toolholder. / Используйте резцы Тип ADKT-T12P ...

Kullanım öncesinde dip boşluk işlenmiş olmalıdır. / The undercut must be placed before axial machining. / Перед использованием нижняя стенка должна быть обработана
 İndekslenildiğinde boy ±0.02mm / Indexability length ±0.02mm / Индексруемая длина ± 0,02 мм

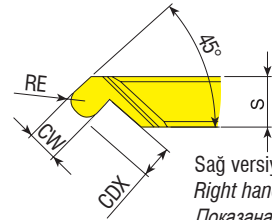
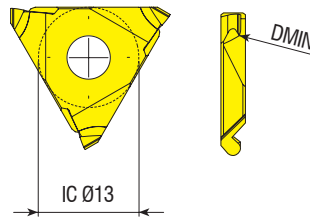
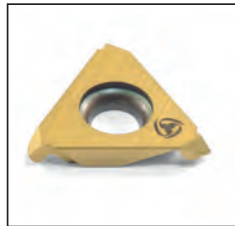

Sağ versiyon gösterilmiştir
 Right hand version shown
 Показана правая версия

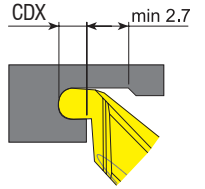

Uç Kodu Insert Code Код Пластина	Stok Stock Наличие		Uç Ölçüleri (mm) Insert Dimension (mm) Размеры (мм)				Kalite Grade Марка твердого сплава	Minimum Çap Ø Minimum Diameter Ø Минимум Диаметр Ø	Kanal Derinliği Depth of Groove Up to Глубина канавки	Kanal Genişliği Width of Groove Ширина канавки	
	R	L	CW	S	RE	CDX					DMIN
T20.00.1220.45.10R/L	●	●	2.0	3.25	1.0	1.8	12	VK20F01	12	1.8	2

AAUT.. Tipi katerlerle kullanınız. / Use with AAUT type toolholder. / Используйте резцы Тип ADKT-T12P ...

Kullanım öncesinde dip boşluk işlenmiş olmalıdır. / The undercut must be placed before axial machining. / Перед использованием нижняя стенка должна быть обработана
 İndekslenildiğinde boy ±0.02mm / Indexability length ±0.02mm / Индексруемая длина ± 0,02 мм

R: Sağ / Right / Правый L: Sol / Left / Левый

● Stokta / In Stock / В наличии ○ Stokta Yok / Non Stock Item / Нет в наличии

Sipariş Örneği/Ordering Example/Образец заказа

1 ad./pcs./шт. AAUT-T20-R-1616-45

BROŞ

BROŞ ÇEKME UÇLARI ve TAKIMLARI
BROACHING INSERTS and TOOLHOLDERS
ДОЛБЯКИ С СМП

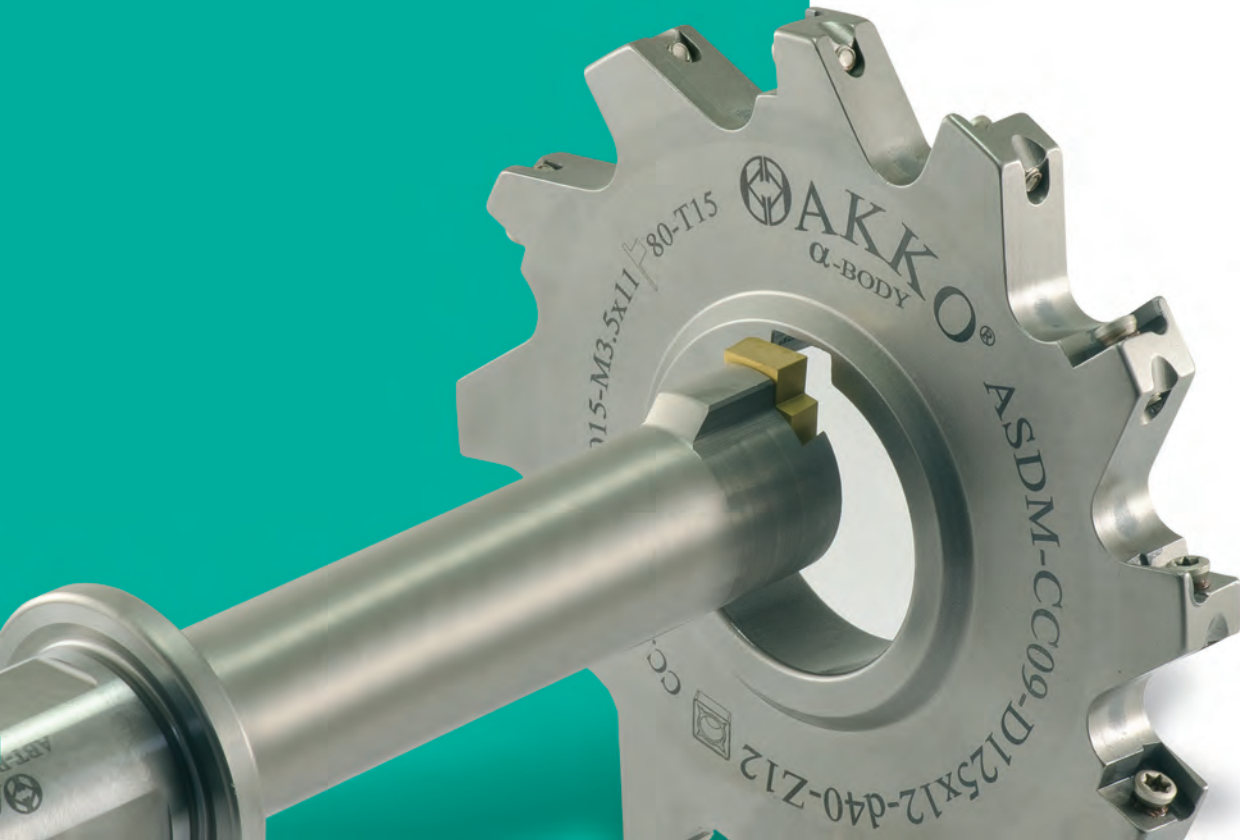
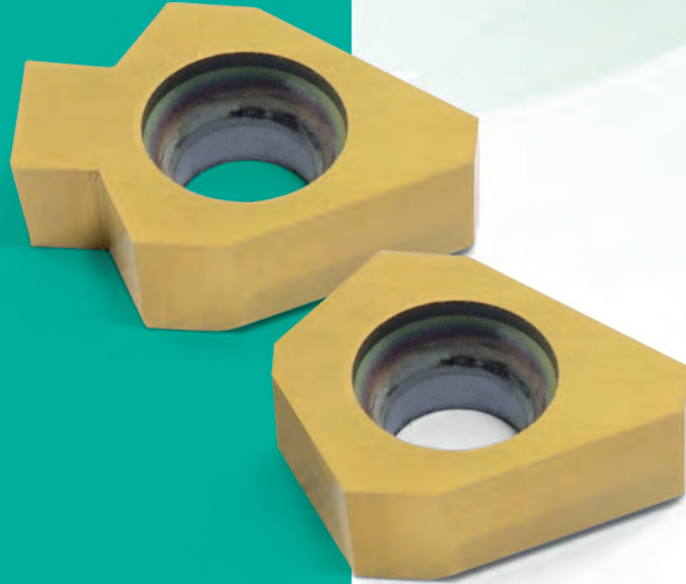

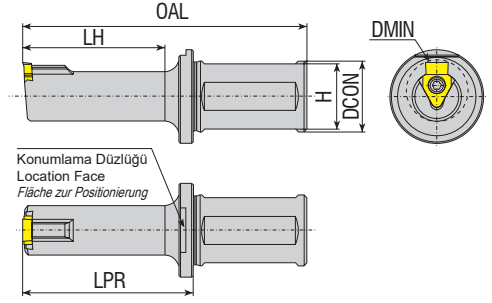

Takım Kodu Ordering Code Код для заказа	Stok Stock Наличие	Takım Ölçüleri (mm) Dimension (mm) Размеры (мм)						Kesici Uç Insert Пластина	Yedek Parçaları / Spare Parts / Запасные части	
		DMIN	LH	DCON	OAL	LPR	H		Sıkma Vidası Screw Зажимной Винт	Tork Anahtar Torx Key Торх Ключ
ABT-B41-D17-Y25-L90-I040	●	17	40	25	90	50	23	B41...	4015-M4x11	80-T15
ABT-B41-D17-Y25-L105-I065	●	17	65	25	105	75	23			
ABT-B41-D22-Y25-L100-I050	●	22	50	25	100	60	23			
ABT-B41-D22-Y25-L125-I070	●	22	70	25	125	80	23			
ABT-B42-D30-Y32-L100-I050	●	30	50	32	100	60	30	B42...	1020-M5x14	80-T20
ABT-B42-D30-Y32-L125-I075	●	30	75	32	125	85	30			
ABT-B42-D30-Y32-L170-I110	●	30	110	32	170	120	30			
ABT-B42-D38-Y32-L100-I050	●	38	50	32	100	60	30			
ABT-B42-D38-Y32-L125-I075	●	38	75	32	125	85	30			
ABT-B42-D40-Y32-L100-I050	●	40	50	32	100	60	30			
ABT-B42-D40-Y32-L125-I075	●	40	75	32	125	85	30			



DIN138 (Tolerans C11) torna ve freze tezgahlarında broş çekme uçları.
DIN138 (Tolerance C11) inserts for keyway broaching on lathe and milling machines.
Допуск на ширину обработанной канавки C11 по DIN138.

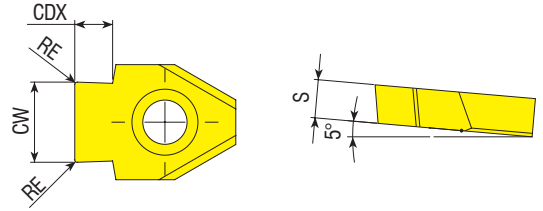

Uç Kodu Insert Code Код Пластина	Stok Stock Наличие	Uç Ölçüleri (mm) Insert Dimension (mm) Размеры (мм)				
		CW	RE	CDX	S	DMIN
B41.00.0612.085.VP3001	●	6.12	0.85	2.6	4.0	22
B41.00.0713.085.VP3001	●	7.13	0.85	3.3	4.0	22
B41.00.0813.105.VP3001	●	8.13	1.05	3.4	4.0	22
B42.00.1013.105.VP3001	●	10.13	1.05	4.2	6.0	30
B42.00.1215.135.VP3001	●	12.15	1.35	5.1	6.0	38
B42.00.1215.175.VP3001	●	12.15	1.75	6.6	6.0	38
B42.00.1215.225.VP3001	●	12.15	2.25	8.5	6.0	38

Tipik kesme şartları / Typical cutting conditions / Режимы резания: İlerleme (Vf): 3000-8000 mm/dak (min) / Paso (ap): 0.02-0.08 mm / Поддача 3000-8000 мм/мин

R: Sağ / Right / Правый L: Sol / Left / Левый

● Stokta / In Stock / В наличии ○ Stokta Yok / Non Stock Item / Нет в наличии

Sipariş Örneği/Ordering Example/Образец заказа
1 ad./pcs./шт. ABT-B41-D17-Y25-L90-I040

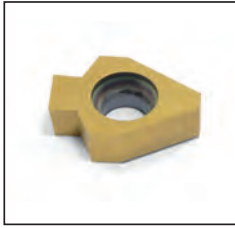

DIN6885 (Tolerans P9) torna ve freze tezgahlarında broş çekme uçları.
DIN6885 (Tolerance P9) inserts for keyway broaching on lathe and milling machines.
Допуск на ширину обработанной канавки P9 под шпонку ГОСТ 23360-78.

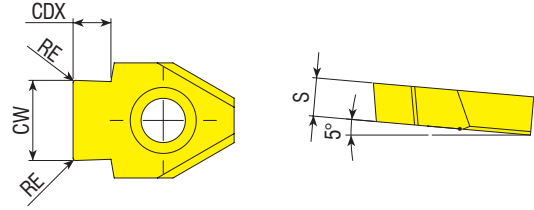

Uç Kodu Insert Code Код Пластина	Stok Stock Наличие	Uç Ölçüleri (mm) Insert Dimension (mm) Размеры (мм)				
		CW	RE	CDX	S	DMIN
B41.00.0498.020.VP3001	●	4.98	0.20	2.7	4.0	17
B41.00.0598.020.VP3001	●	5.98	0.20	3.4	4.0	17
B41.00.0798.020.VP3001	●	7.98	0.20	4.1	4.0	22
B42.00.0998.030.VP3001	●	9.98	0.30	4.2	6.0	30
B42.00.1197.030.VP3001	●	11.97	0.30	5.7	6.0	38
B42.00.1397.030.VP3001	●	13.97	0.30	6.8	6.0	40

Tipik kesme şartları / Typical cutting conditions / Режимы резания: İlerleme (Vf): 3000-8000 mm/dak (min) / Paso (ap): 0.02-0.08 mm / Поддача 3000-8000 мм/мин



DIN6885 (Tolerans JS9) torna ve freze tezgahlarında broş çekme uçları.
DIN6885 (Tolerance JS9) inserts for keyway broaching on lathe and milling machines.
Допуск на ширину обработанной канавки JS9 под шпонку ГОСТ 23360-78.

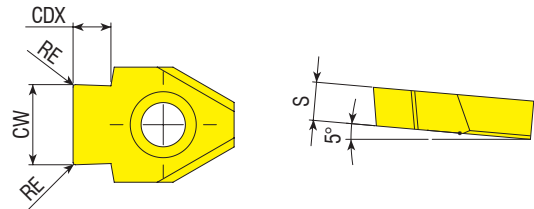

Uç Kodu Insert Code Код Пластина	Stok Stock Наличие	Uç Ölçüleri (mm) Insert Dimension (mm) Размеры (мм)				
		CW	RE	CDX	S	DMIN
B41.00.0501.020.VP3001	●	5.01	0.20	2.7	4.0	17
B41.00.0601.020.VP3001	●	6.01	0.20	3.4	4.0	17
B41.00.0801.020.VP3001	●	8.01	0.20	4.1	4.0	22
B42.00.1001.030.VP3001	●	10.01	0.30	4.2	6.0	30
B42.00.1200.050.VP3001	●	12.00	0.50	8.5	6.0	38
B42.00.1201.030.VP3001	●	12.01	0.30	5.7	6.0	38
B42.00.1401.030.VP3001	●	14.01	0.30	6.8	6.0	40

Tipik kesme şartları / Typical cutting conditions / Режимы резания: İlerleme (Vf): 3000-8000 mm/dak (min) / Paso (ap): 0.02-0.08 mm / Поддача 3000-8000 мм/мин

R: Sağ / Right / Правый L: Sol / Left / Левый
● Stokta / In Stock / В наличии ○ Stokta Yok / Non Stock Item / Нет в наличии

Sipariş Örneği/Ordering Example/Образец заказа
1 ad./pcs./шт. B41.00.0498.020.VP3001

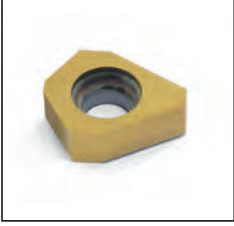

Torna ve freze tezgahlarında kama kanalı pah kırma uçları.
Inserts for keyway chamfering on lathe and milling machines.
Пластины для снятия фасок на шпоночном пазу

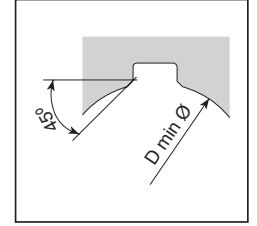
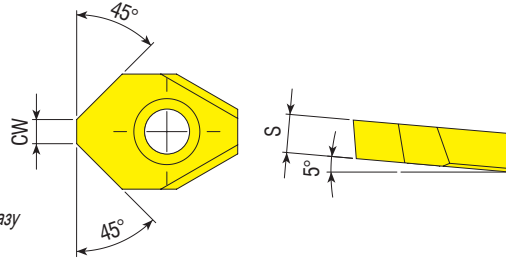

Uç Kodu
Insert Code
Код Пластина

Stok
Stock
Наличие

Uç Ölçüleri (mm)
Insert Dimension (mm)
Размеры (мм)

D MIN

CW

S

B41.00.0150.CH.VP3001

●

17

1.5

4.0

B41.00.0300.CH.VP3001

●

22

3.0

4.0

B42.00.0600.CH.VP3001

●

30

6.0

6.0

Tipik kesme şartları / Typical cutting conditions / Standard-Schneidbedingungen: İlerleme (Vf): 3000-8000 mm/dak (min) / Paso (ap): 0.02-0.08 mm / Vorschub (Vf): 3000-8000 mm/min

R: Sağ / Right / Правый L: Sol / Left / Левый

Sipariş Örneği/Ordering Example/Образец заказа

● Stokta / In Stock / В наличии ○ Stokta Yok / Non Stock Item / Нет в наличии

1 ad./pcs./шт. B41.00.0150.CH.VP3001

PROFİL VERİLMİŞ UÇLAR / PROFILED INSERTS / ПРОФИЛЬНЫЕ ПЛАСТИНЫ
ÖRNEK PROFİLLER / EXAMPLES OF PROFILES / ПРИМЕРЫ ВОЗМОЖНЫХ ПРОФИЛЕЙ ПЛАСТИН

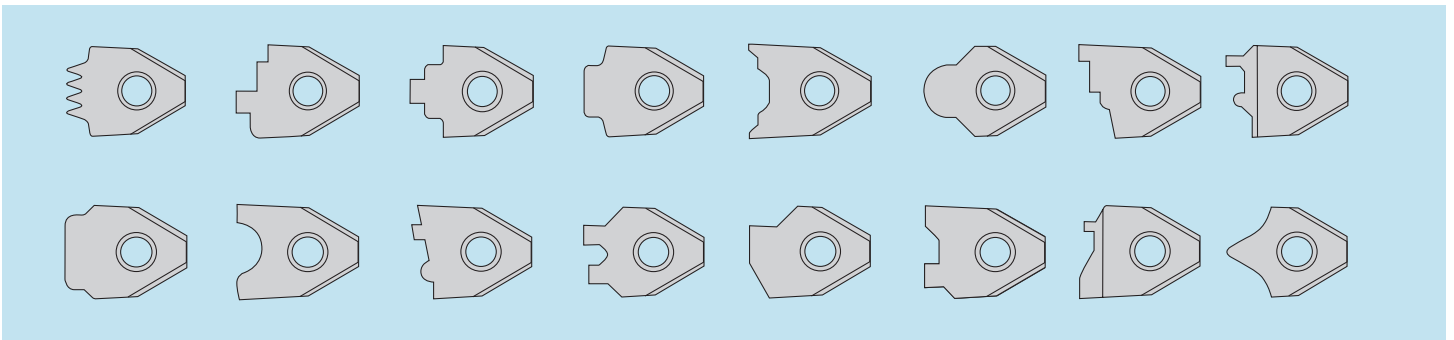

Profil uçlar müşterilerimizin özel taleplerine göre üretilmektedir.
Profiled inserts are manufactured according to customer special requirements.
Профильные пластины изготавливаются согласно чертежам заказчика

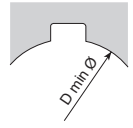
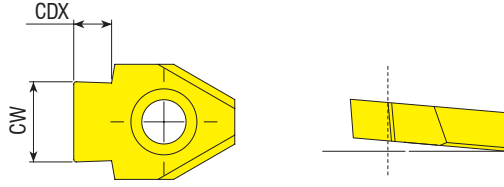
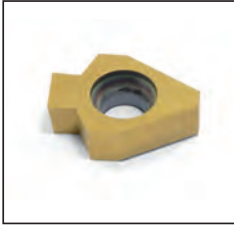

Kanal Genişliği Slot With Ширина канавки	Tolerans Tolerance Толерансы	Uç Ölçüsü Insert Size mm Размеры (мм)	W	t _{max}	Uçlar Inserts Пластинал	Uygulanabilir takım ve uç bağlantısı ile Dmin tablosu Applicable Dmin for toolholders and inserts table Таблица Dmin для инструмента и пластин				
						ABT-B41-D17...	ABT-B41-D22...	ABT-B42-D30...	ABT-B42-D38...	ABT-B42-D40...
6	C11	6	6.12	2.6	B41.00.0612.085.VP3001		22	X	X	X
7		7	7.13	3.3	B41.00.0713.085.VP3001		22	X	X	X
8		8	8.13	3.4	B41.00.0813.105.VP3001		22	X	X	X
10		10	10.13	4.2	B42.00.1013.105.VP3001	X	X	30	X	X
12		12		5.1	B42.00.1215.135.VP3001	X	X	X	38	
16		12	12.15	6.6	B42.00.1215.175.VP3001	X	X	X	38	
24		12		8.5	B42.00.1215.225.VP3001	X	X	X	38	
5	P9	5	4.98	2.7	B41.00.0498.020.VP3001	17		X	X	X
6		6	5.98	3.4	B41.00.0598.020.VP3001	17		X	X	X
8		8	7.98	4.1	B41.00.0798.020.VP3001		22	X	X	X
10		10	9.98	4.2	B42.00.0998.030.VP3001	X	X	30		
12		12	11.97	5.7	B42.00.1197.030.VP3001	X	X		38	
14		14	13.97	6.8	B42.00.1397.030.VP3001	X	X			40
5	JS9	5	5.01	2.7	B41.00.0501.020.VP3001	17		X	X	X
6		6	6.01	3.4	B41.00.0601.020.VP3001	17		X	X	X
8		8	8.01	4.1	B41.00.0801.020.VP3001		22	X	X	X
10		10	10.01	4.2	B42.00.1001.030.VP3001	X	X	30		
12		12	12.00	8.5	B42.00.1200.050.VP3001	X	X		38	
12		12	12.01	5.7	B42.00.1201.030.VP3001	X	X		38	
14		14	14.01	6.8	B42.00.1401.030.VP3001	X	X			40

BROŞ UCU BİLGİ ALMA FORMU

BROACHING INSERT INFORMATION FORM

ФОРМА ДЛЯ КОМПЛЕКТАЦИИ ДОЛБЕЖНЫХ РЕЗЦОВ ПЛАСТИНАМИ

Broş ve Delik Ölçüleri / Dimension of Bore / Размер отверстия

b	
t	
r	
d/min*	
İş Parçası Malzemesi Work Material Рабочий материал	
Tolerans Grubu / Tolerance Group / Варианты совместимости	
C11	P9 JS9 CUSTOM

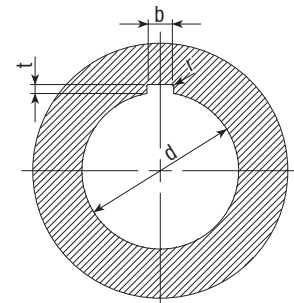

SUPAP

SUPAP YUVASI İŞLEME UÇLARI ve TAKIMLARI
VALVE SEAT INSERTS and TOOLHOLDERS
ИНСТРУМЕНТ ДЛЯ ОБРАБОТКИ СЕДЕЛ КЛАПАНОВ



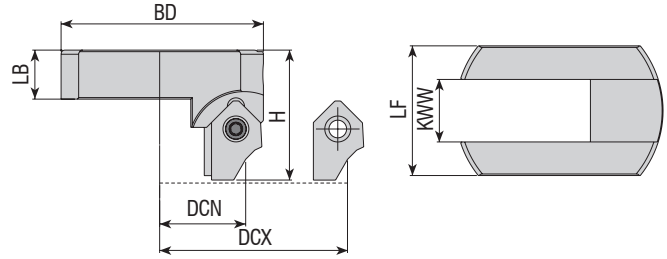

Takım Kodu Ordering Code Код для заказа	Stok Stock Наличие	Takım Ölçüleri (mm) Dimension (mm) Размеры (мм)						Yedek Parçaları / Spare Parts / Запасные части				
		DCN DCX	BD	LB	H	KWW	LF	Kesici Uç Insert Пластина	Sıkma Vidası Screw Зажимной винт	Tork Anahtar Torx Key Торх Ключ	Ayar Vidası Adjustable Регулировочный винт	Anahtar Allen Key Ключ
VST-B11-2842	●	28-42	29	9.5	28.5	12	25.0					
VST-B11-4058	●	40-58	39	9.5	25.0	12	25.0	B11...	3008-M3x8	80-T08	2725-M5x10	AAL-01-02

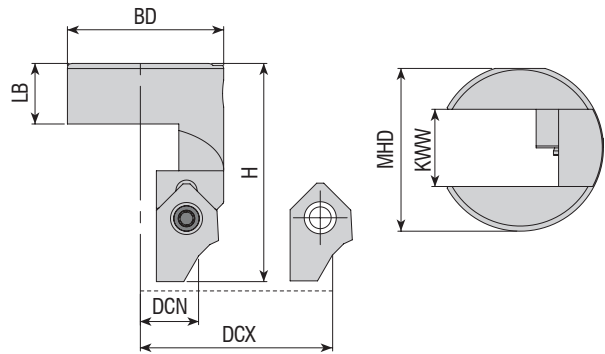

Takım Kodu Ordering Code Код для заказа	Stok Stock Наличие	Takım Ölçüleri (mm) Dimension (mm) Размеры (мм)						Yedek Parçaları / Spare Parts / Запасные части				
		DCN DCX	BD	LB	H	KWW	MHD	Kesici Uç Insert Пластина	Sıkma Vidası Screw Зажимной винт	Tork Anahtar Torx Key Торх Ключ	Ayar Vidası Adjustable Регулировочный винт	Anahtar Allen Key Ключ
VST-B11-1830	●	18-30	24	9.5	34.0	12	25.3					

R: Sağ / Right / Правый L: Sol / Left / Левый
● Stokta / In Stock / В наличии ○ Stokta Yok / Non Stock Item / Нет в наличии

Sipariş Örneği/Ordering Example/Образец заказа
1 ad./pcs./шт. VST-B11-2842

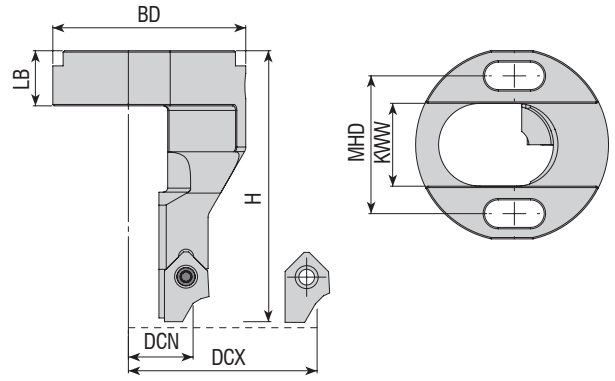

Takım Kodu Ordering Code Код для заказа	Stok Stock Наличие	Takım Ölçüleri (mm) Dimension (mm) Размеры (мм)						Kesici Uç Insert Пластина	Yedek Parçaları / Spare Parts / Запасные части				
		DCN DCX	BD	LB	H	KWW	MHD		Sıkma Vidası Screw Зажимной винт	Tork Anahtar Torx Key Торх Ключ	Ayar Vidası Adjustable Регулируемый винт	Anahtar Allen Key Ключ	
VST-B11-2032	●	20-32	42	12	59	18	30	B11...	3008-M3x8	80-T08	2702-M4x10	AAL-01-02	
VST-B11-2434	●	24-34	26	14	40	11	18.1						

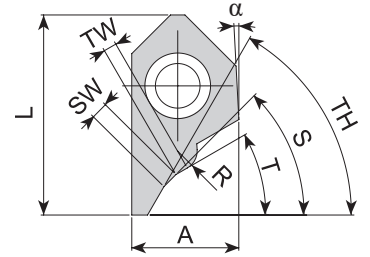
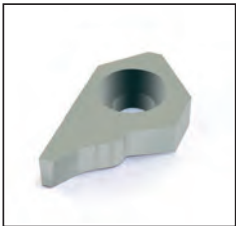

Uç Kodu Insert Code Код Пластина	Stok Stock Наличие	Uç Ölçüleri (mm) Insert Dimension (mm) Размеры (мм)								
		S°	SW	T°	TW	TH°	A	L	α	R
B11013	●	45°	1.3	30°	1	60°	8.15	15.10	3°	1.50

R: Sağ / Right / Правый L: Sol / Left / Левый

● Stokta / In Stock / В наличии ○ Stokta Yok / Non Stock Item / Нет в наличии

Sipariş Örneği/Ordering Example/Образец заказа

1 ad./pcs./шт. VST-B11-2032

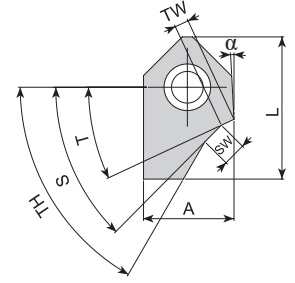
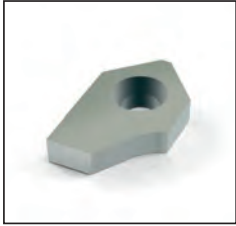

Uç Kodu Insert Code Код Пластина	Stok Stock Наличие	Uç Ölçüleri (mm) Insert Dimension (mm) Размеры (мм)							
		S ⁰	SW	T ⁰	TW	TH ⁰	A	L	α
B11003	●	45°	1.3	25°	1.1	52°	9.7	15.25	3°
B11004	●	45°	1.6	25°	1.3	52°	9.7	15.25	3°
B11005	●	45°	2	25°	1.3	52°	9.7	15.25	3°
B11006	●	45°	2.5	25°	1.5	52°	9.7	15.25	3°
B11007	●	45°	1.5	30°	1.5	60°	9.7	15.25	3°
B11008	●	45°	1.3	25°	1.1	60°	9.7	15.25	3°
B11009	●	45°	1.6	25°	1.3	60°	9.7	15.25	3°
B11010	●	45°	2	25°	1.3	60°	9.7	15.25	3°
B11011	●	30°	2	15°	1.8	60°	9.7	15.25	3°
B11012	●	36°	2	15°	1.6	60°	9.7	15.25	3°
B11014	●	45°	2.5	25°	1.5	60°	9.7	15.25	3°
B11016	●	30°	1.5	15°	1.3	60°	9.7	15.25	3°
B11017	●	30°	2.5	15°	1.8	60°	9.7	15.25	3°
B11018	●	36°	2.5	15°	1.6	60°	9.7	15.25	3°
B11019	●	20°	2.5	10°	2	75°	9.7	15.25	3°
B11020	●	45°	1.3	25°	1.1	52°	7.7	15.25	3°
B11021	●	30°	3	15°	1.8	60°	9.7	15.25	3°
B11022	●	45°	3	30°	1.8	60°	9.7	15.25	3°
B11029	●	40°	2.5	25°	1.5	60°	9.7	15.25	3°
B11030	●	20°	2	10°	1.3	60°	9.7	15.25	3°
B11031	●	45°	1.8	30°	1.3	60°	9.7	15.25	3°
B11032	●	45°	1.5	30°	1	52°	9.7	15.25	3°
B11033	●	45°	2	30°	1.1	52°	9.7	15.25	3°
B11034	●	45°	2.5	30°	1.3	52°	9.7	15.25	3°
B11035	●	30°	1.5	15°	1	45°	9.7	15.25	3°
B11036	●	30°	2	15°	1.1	45°	9.7	15.25	3°
B11037	●	30°	2.5	15°	1.3	45°	9.7	15.25	3°

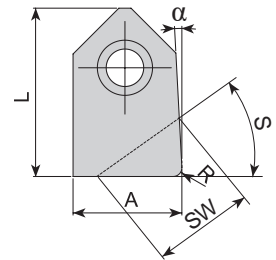
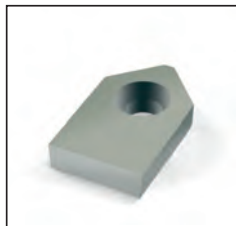

Uç Kodu Insert Code Код Пластина	Stok Stock Наличие	Uç Ölçüleri (mm) Insert Dimension (mm) Размеры (мм)					
		S ⁰	SW	A	L	α	R
B11015	●	0°	9.85	9.85	15.10	3°	0.80
B11023	●	0°	7.7	7.7	15.10	3°	0.80
B11024	●	20°	8.2	9.75	15.10	3°	-
B11025	●	25°	10	9.65	15.10	3°	-
B11026	●	30°	9	9.65	15.10	3°	-
B11027	●	35°	10	9.60	15.10	3°	-
B11028	●	45°	8.9	9.55	15.10	3°	-

R: Sağ / Right / Правый L: Sol / Left / Левый

● Stokta / In Stock / В наличии ○ Stokta Yok / Non Stock Item / Нет в наличии

Sipariş Örneği/Ordering Example/Образец заказа

1 ad./pcs./шт. B11003

WHIRLING

WHIRLING UÇLARI ve TAKIMLARI

WHIRLING INSERTS and TOOLHOLDERS

ИНСТРУМЕНТ ДЛЯ ВИХРЕВОГО РЕЗЬБОФРЕЗЕРОВАНИЯ

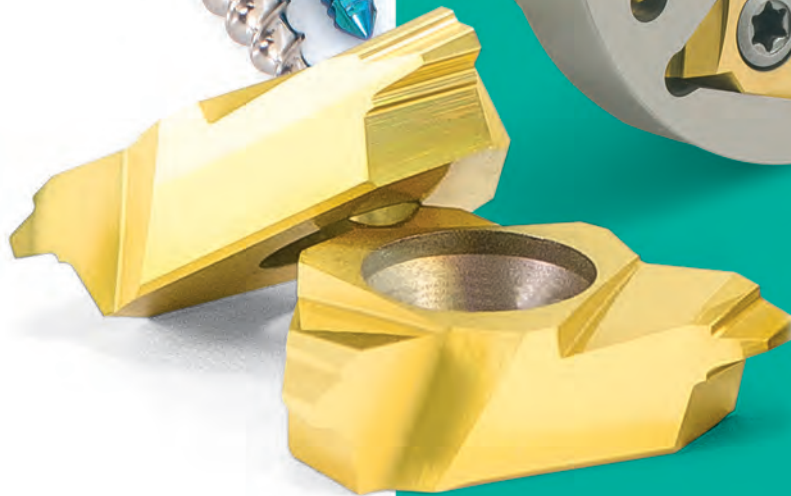

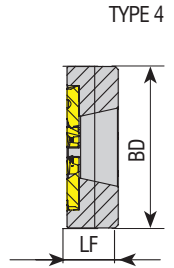
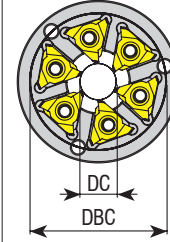
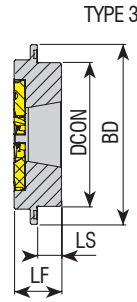
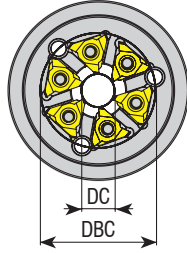
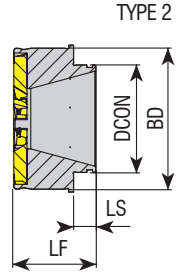
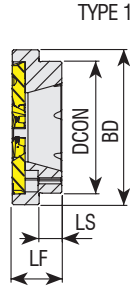
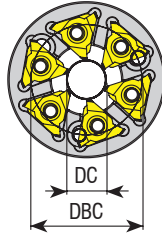

Makine Machine Станок	Tahrikli Whirling Ünitesi Aggregate Whirling Unit Агрегирования	Whirling Ring Kodu Whirling Ring Code Whirling Ring Kod	Stok Stock Наличие	Takım Ölçüleri (mm) Dimension (mm) Размеры (мм)								Kesici Uç Insert Пластина	Yedek Parçaları / Spare Parts / Запасные части				
				ZEFP	DC	DCON	DBC	BD	LS	LF	TYPE		Sıkma Vidası Screw Зажимной винт	Tork Anahtar Torx Key Торх Ключ			
STAR	5914 72 00/68172	ATW-301-T09-D1240-Z06	●	6	12	40	33	47	7	15	1						
CITIZEN	BTW1000	ATW-302-T09-D1233-Z06	○	6	12	33	40	47	4	18.5	-						
	GSW101	ATW-303-T09-D0620-Z06	○	6	6	20	26	35	3.2	15	1						
	MWS101/KSW101	ATW-304-T09-D1240-Z06	○	6	12	40	32.5	46	2.5	15.5	1						
	LSW101/BSW215/ LSW215315																
	LSW424														ATW-305-T09-D1245-Z06	○	6
TORNOS	306101/307087	ATW-306-T09-D1240-Z06	●	6	12	40	31	57	3.5	15	-				T09....	4015 M4x11	80-T15
	417617	ATW-307-T09-D1250-Z06	○	6	12	50	40	67	3.5	15.4	-						
WTO	TN762004	ATW-308-T09-D1142-Z06	●	6	11	31.97	-	42	6.7	24.7	2						
	TN762006	ATW-309-T09-D2054-Z08	○	8	20	56.5	-	54	1.5	13.8	2						
TSUGAMI	3234 Y342	ATW-310-T09-D1252-Z06	●	6	12	52	42	65	8.7	17	3						
	3268 Y452	ATW-311-T09-D1252-Z06	○	6	12	52	44	52	10	10	3						
	3268 Y271	ATW-312-T09-D1252-Z06	○	6	12	52	38	54	6	19	3						
	3214 Y342	ATW-313-T09-D1650-Z06	○	6	16	50	40	62	8.5	20	3						
	3234 Y342	ATW-314-T09-D2052-Z06	○	6	20	52	42	65	8.7	17	3						
	3281-Y451	ATW-316-T09-D1252-Z06	●	6	12	52	44	52	-	17	4						
HANWHA	MADAULA	ATW-315-T09-D1245-Z06	○	6	12	45	-	56	8.5	15	1						

R: Sağ / Right / Правый L: Sol / Left / Левый
● Stokta / In Stock / В наличии ○ Stokta Yok / Non Stock Item / Нет в наличии

Sipariş Örneği/Ordering Example/Образец заказа
1 ad./pcs./шт. ATW-301-T09-D1240-Z06

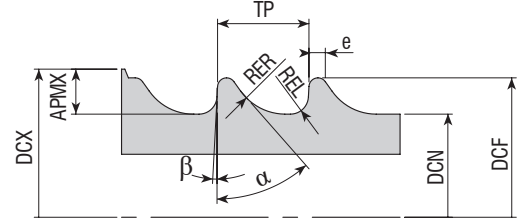
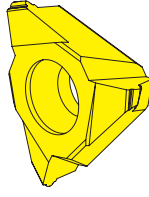
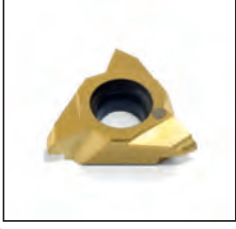

Uç Kodu Insert Code Код Пластина	Kalite Grade Марка твердого сплава		Standart ISO5835	Uç Ölçüleri (mm) Insert Dimension (mm) Размеры (мм)									
	VK15U	VK15U01		TP	e	DCF	DCN	RER	REL	α	β	APMX	DCX
T09.HA150.D12	●	●	HA1.5	0.5	0.1	1.35 to 1.5	1.0 to 1.1	0.30	0.1	35°	3°	4	9
T09.HA200.D12	●	●	HA2.0	0.6	0.1	1.85 to 2.0	1.2 to 1.3	0.40	0.1	35°	3°	4	9
T09.HA270.D12	●	●	HA2.7	1	0.1	2.55 to 2.7	1.75 to 1.9	0.60	0.2	35°	3°	4	9.5
T09.HA350.D12	●	●	HA3.5	1.25	0.1	3.35 to 3.5	2.25 to 2.4	0.80	0.2	35°	3°	4	10
T09.HA400.D12	●	●	HA4.0	1.5	0.1	3.85 to 4.0	2.75 to 2.9	0.80	0.2	35°	3°	4	10.5
T09.HA450.D12	●	●	HA4.5	1.75	0.1	4.35 to 4.5	2.85 to 3.0	1.00	0.3	35°	3°	4	11
T09.HA500.D12	●	●	HA5.0	1.75	0.1	4.85 to 5.0	3.35 to 3.5	1.00	0.3	35°	3°	4	11
T09.HB400.D12	●	●	HB4.0	1.75	0.1	3.85 to 4.0	1.75 to 1.9	0.80	0.3	25°	5°	4	9.5
T09.HB650.D12	●	●	HB6.5	2.75	0.2	6.35 to 6.5	2.85 to 3.0	1.20	0.8	25°	5°	4	11

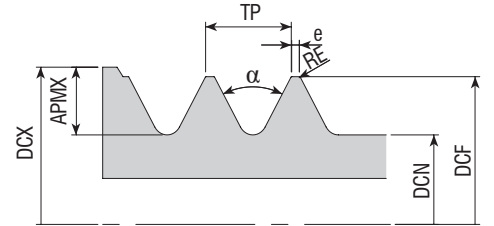
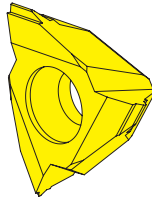
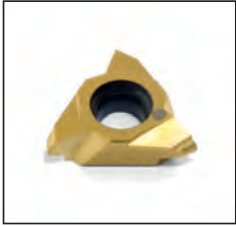

Uç Kodu Insert Code Код Пластина	Kalite Grade Марка твердого сплава		Standart ISO9268	Uç Ölçüleri (mm) Insert Dimension (mm) Размеры (мм)							
	VK15U	VK15U01		TP	e	DCF	DCN	α	RE	APMX	DCX
T09.HC290.D12	○	○	HC2.9	1.06	0.1	2.79 to 2.90	2.03 to 2.18	60°	0.01	4	10.5
T09.HC350.D12	○	○	HC3.5	1.27	0.1	3.43 to 3.53	2.51 to 2.64	60°	0.01	4	11
T09.HC390.D12	○	○	HC3.9	1.27	0.1	3.78 to 3.91	2.77 to 2.92	60°	0.01	4	11.5
T09.HC420.D12	○	○	HC4.2	1.27	0.1	4.09 to 4.22	2.95 to 3.25	60°	0.01	4	12

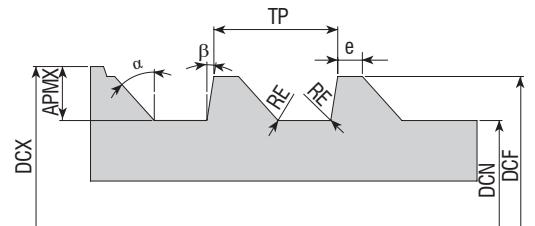
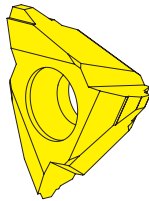
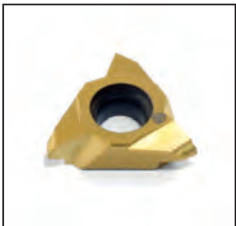

Uç Kodu Insert Code Код Пластина	Kalite Grade Марка твердого сплава		Standart ISO9268	Uç Ölçüleri (mm) Insert Dimension (mm) Размеры (мм)									
	VK15U	VK15U01		TP	e	DCF	DCN	RE	α	β	APMX	DCX	
T09.HD400.D12	○	○	HD4.0	1.59	0.1	3.97 to 4.03	2.89 to 2.95	0.01	45°	10°	4	11.5	
T09.HD450.D12	○	○	HD4.5	2.18	0.1	4.47 to 4.53	2.89 to 2.95	0.01	45°	10°	4	12	

R: Sağ / Right / Правый L: Sol / Left / Левый
● Stokta / In Stock / В наличии ○ Stokta Yok / Non Stock Item / Нет в наличии

Sipariş Örneği/Ordering Example/Образец заказа
1 ad./pcs./шт. T09.HA150.D12

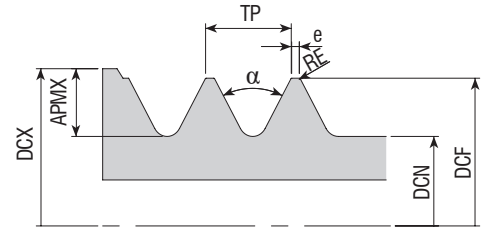
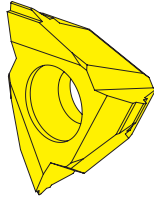
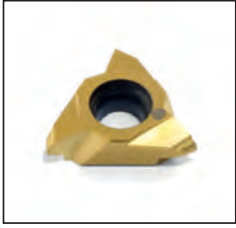

Uç Kodu Insert Code Код Пластина	Kalite Grade Материал пластины		Standart DIN13	Uç Ölçüleri (mm) Insert Dimension (mm) Размеры (мм)						
	VK15U	VK15U01		TP	DCF	DCN	a	RE	APMX	DCX
T09.M200.D12	●	●	M2	0.4	2	1.509	60	0.048	4	9
T09.M250.D12	●	●	M2.5	0.45	2.5	1.928	60	0.055	4	9.5
T09.M300.D12	●	●	M3	0.5	3	2.387	60	0.062	4	10
T09.M350.D12	●	●	M3.5	0.6	3.5	2.744	60	0.077	4	8.5
T09.M400.D12	●	●	M4.0	0.7	4	3.141	60	0.091	4	11
T09.M500.D12	●	●	M5.0	0.8	5	4.019	60	0.105	4	11.5
T09.M600.D12	●	●	M6.0	1	6	4.773	60	0.134	4	12.5
T09.M700.D12	●	●	M7.0	1	7	5.753	60	0.134	4	13.5
T09.M800.D12	●	●	M8.0	1.25	8	6.446	60	0.17	4	14

Kesme başlangıç pozisyonu
Cutting Start Position
Стартовая позиция

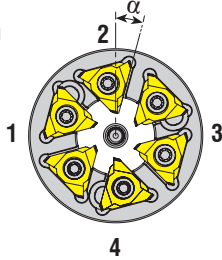

Y Eksen
Y Axis
Y ось

İş parçası dönüş yönü
Turning Direction of Workpiece
Направление вращения заготовки



Whirling ünitesi dönüş yönü
Turning Direction of Whirling unit
Направление вращения резцовфрезы

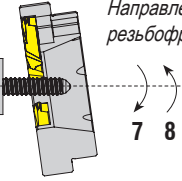

Makine Özellikleri Machine Specifications Данные об оборудовании		Malzeme Özellikleri Material Specifications Данные о детали	
Makine Üreticisi Machine Manufacturer Производитель станков		Malzeme (DIN, AISI v.b.) Material (DIN, AISI etc.) Обрабатываемый материал (DIN, AISI и т. д.)	
Makine Modeli Machine Model Модель станка		Ham Malzeme Çapı Raw Material Diameter Диаметр заготовки	
Tahrikli Whirling Ünitesi Üreticisi Live Tool Manufacturer Производитель приводного блока		Diş Profili Thread Profile Профиль зуба	
Tahrikli Whirling Ünitesi Aggregate Whirling Unit Агрегирования		Profil Teknik Resmi Profile Technical Drawing Ссылка на чертёж	
Y - Eksen Y - Axis Y - ось	Var <input type="checkbox"/> Exist Да <input type="checkbox"/>	Yok <input type="checkbox"/> None Нет <input type="checkbox"/>	Hatve Pitch Шаг
Yüksek Basıncılı Soğutma High Pressure Coolant Охлаждение под высоким давлением	Var <input type="checkbox"/> Exist Да <input type="checkbox"/>	Yok <input type="checkbox"/> None Нет <input type="checkbox"/>	Tek Ağız One Start Первый зуб
Kesme Başlangıç Pozisyonu Cutting Start Position Стартовая позиция	1 <input type="checkbox"/> 2 <input type="checkbox"/> 3 <input type="checkbox"/> 4 <input type="checkbox"/>		İki Ağız Two Starts Второй зуб
Whirling Ünitesi Dönüş Yönü Turning Direction of Whirling Unit Направление вращения резцовфрезы	5 <input type="checkbox"/> 6 <input type="checkbox"/>		Müşteri Adı / Customer Name / Покупатель: Yetkili / Responsible Person / Должность:
İş Parçası Dönüş Yönü Turning Direction of Workpiece Направление вращения заготовки	7 <input type="checkbox"/> 8 <input type="checkbox"/>		
α Açısı α Angle α Угол	Not: Bu açı ürün performansına etki ettiğinden bildirilmesi gerekmektedir. Aksi halinde ring tarafımıza gönderilmelidir. Note: This angle effects the performance of inserts. If doesn't known, tool body should be send to AKKO. Примечание: если угол установки пластин а неизвестен, то необходимо предоставить образец фрезы.		
Not / Note / Примечание:			

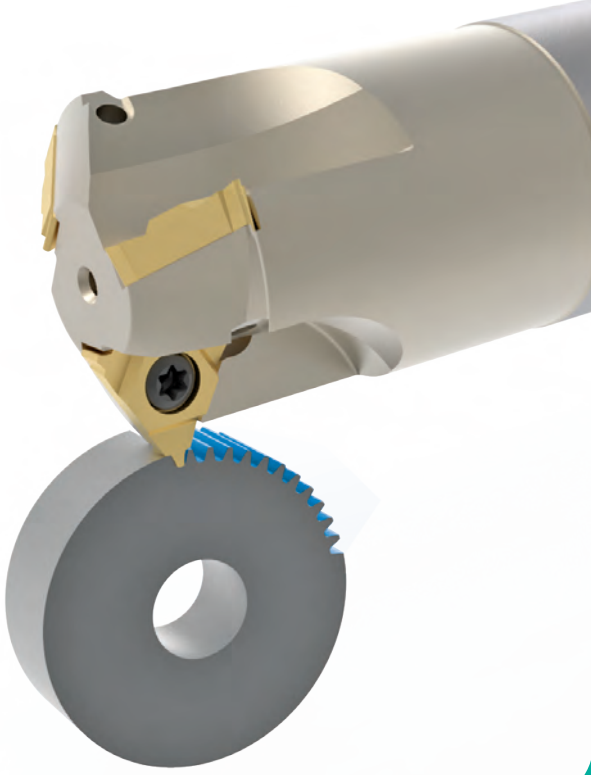

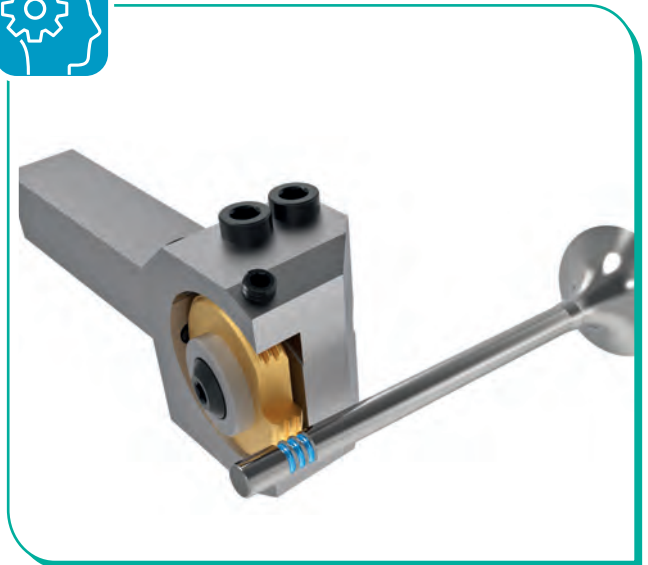
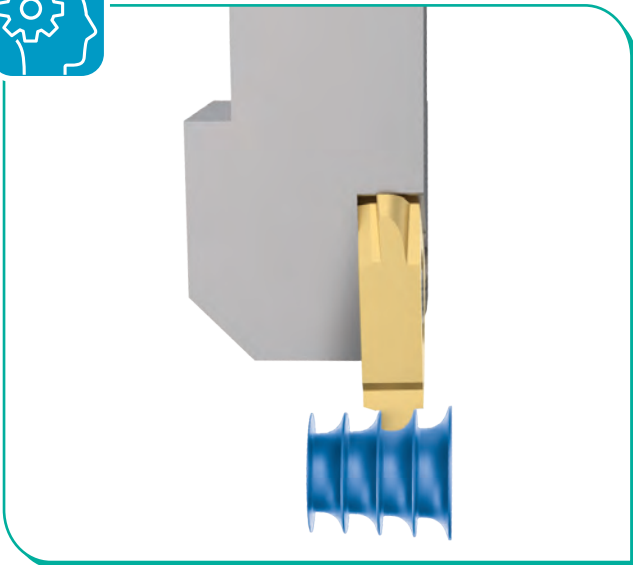
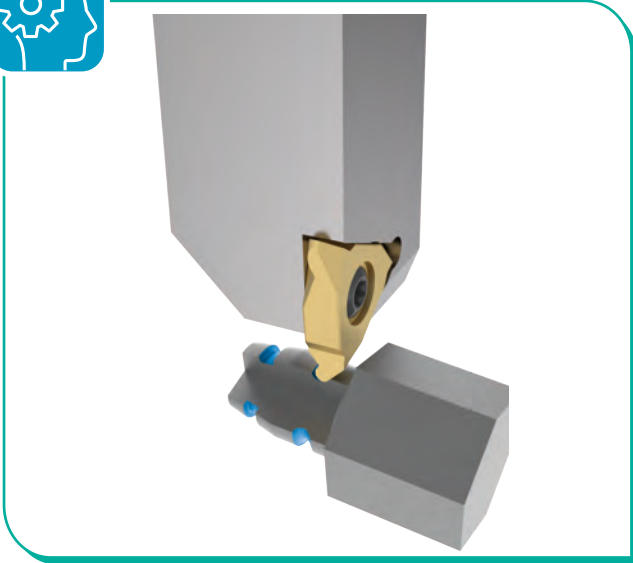
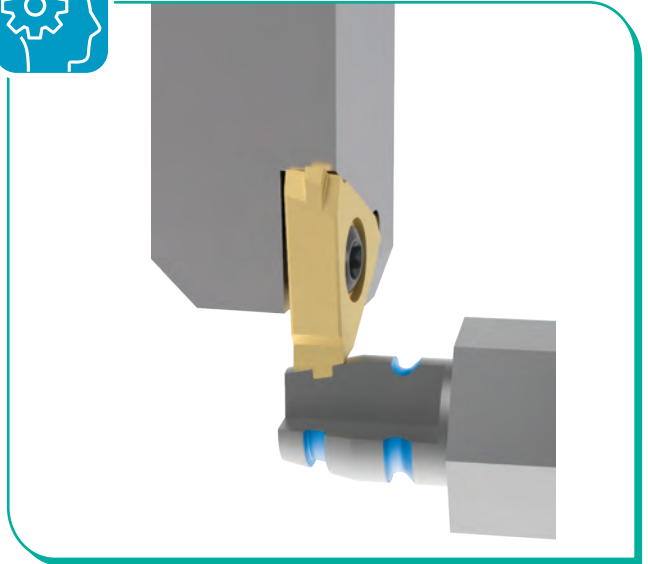
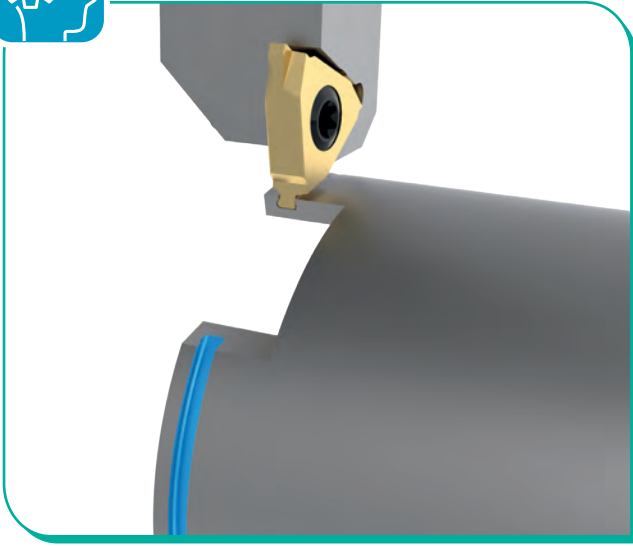



DIŞ TORNA TAKIMLARI
EXTERNAL TURNING TOOLHOLDERS
ДЕРЖАВКИ ДЛЯ НАРУЖНОГО ТОЧЕНИЯ





P **S** **K** **N** **R**

1 2 3 4 5

1 Sıkma Tipi / Method of Mounting of Insert / Способ монтажа вставки



2 Uç Tipi / Type of Insert / Форма пластины

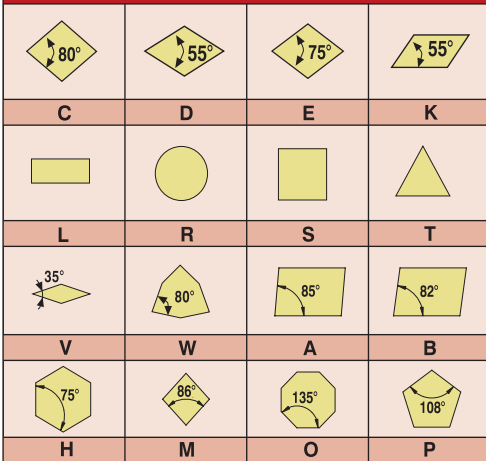

3 Yanaşma Açısı / Tool Holder Shape Bar Geometry / Угол направления

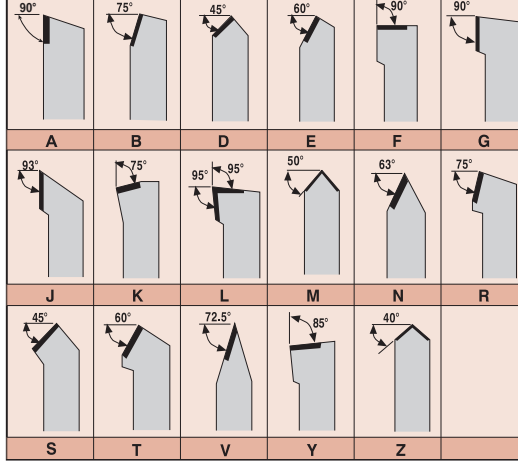

4 Serbest Uç Açısı / Insert Clearance Angle / Freiwinkel / Задний угол пластины

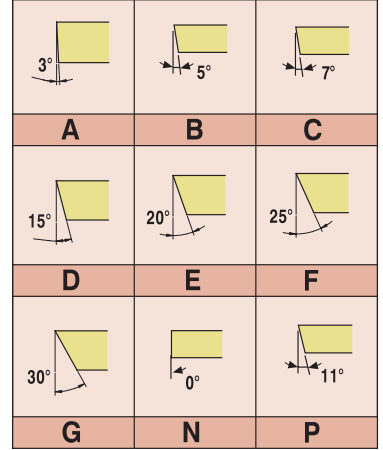

25 **25** - **M** **12** **C**

6 7 8 9 10

5 Kesme Yönü / Cutting Direction / Направление резания

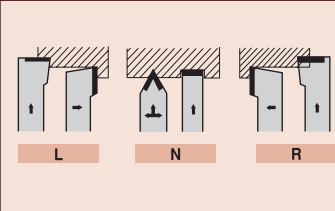

6 Kesme Kenar Yüksekliği / Cutting Edge Height / Высота режущей кромки

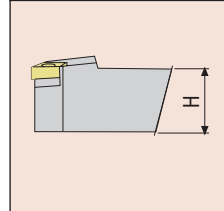

7 Şaft Genişliği / Shank Width / Ширина хвостовика

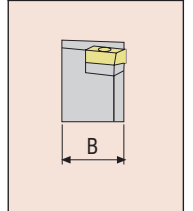

8 Şaft Boyu / Shank Length / Длина хвостовика

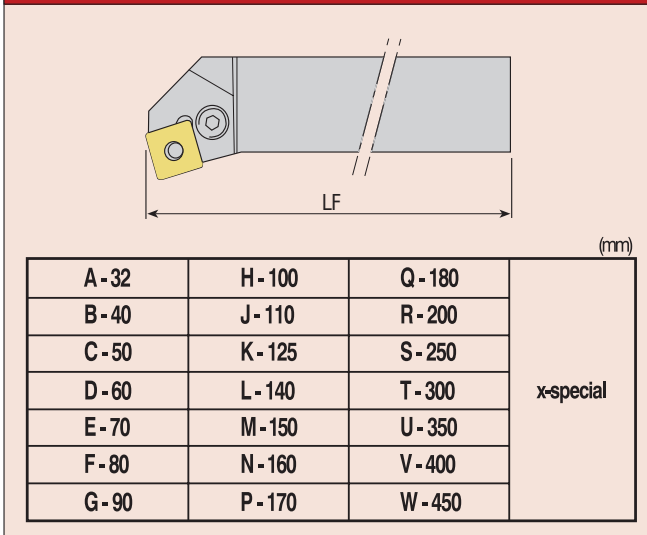

9 Kesme Kenar Uzunluğu / Cutting Edge Length / Длина режущей кромки

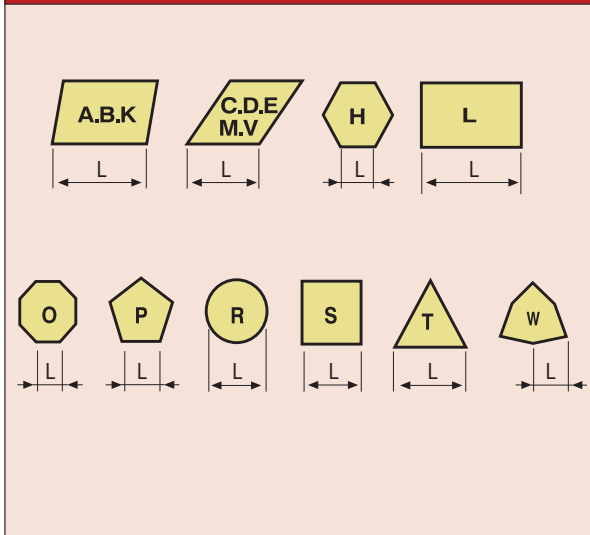

10 Baskı Pabucu / Wedge Clamp / Прижим

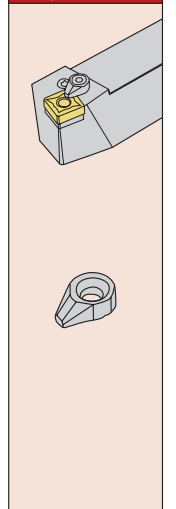



*konusulan
the spoken kalite...
quality...*

T-SİSTEM

T-SİSTEM DIŞ TORNA KATERLERİ
T-SYSTEM EXTERNAL TURNING TOOLHOLDERS
T-ТИП ДЕРЖАВКИ ДЛЯ НАРУЖНОГО ТОЧЕНИЯ



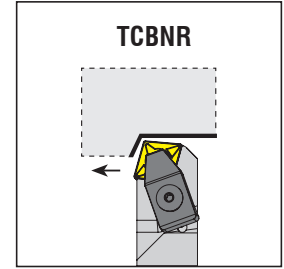
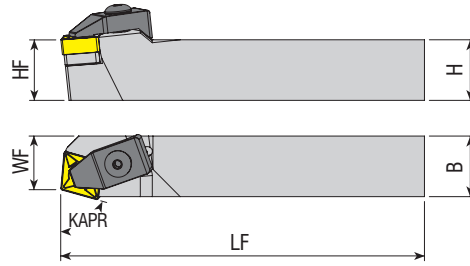

Takım Kodu Ordering Code Код для заказа	Stok Stock Наличие		Takım Ölçüleri (mm) Dimension (mm) Размеры (мм)				Kesici Uç Insert Пластина	Yedek Parçaları / Spare Parts / Запасные части							
	R	L	HF=H	B	LF	WF		Baskı Pabuçu Wedge Clamp Прижим	Pabuç Vidası Clamp Screw Зажимной винт	Altlık Shim Опорная пластина	Altlık Vidası Shim Screw Винт опорной пластины	Yay Spring Пружина	Pul Stamp Шайба	Anahtar Allen Key Ключ	
TCBNR/L 2525 M16	●	●	25	25	150	22									

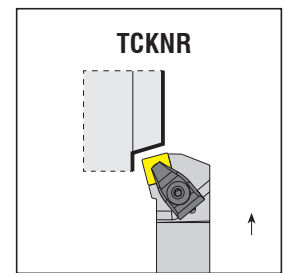
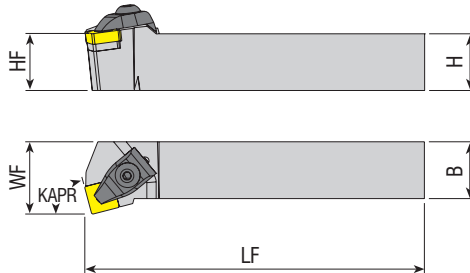

Takım Kodu Ordering Code Код для заказа	Stok Stock Наличие		Takım Ölçüleri (mm) Dimension (mm) Размеры (мм)				Kesici Uç Insert Пластина	Yedek Parçaları / Spare Parts / Запасные части														
	R	L	HF=H	B	LF	WF		Baskı Pabuçu Wedge Clamp Прижим	Pabuç Vidası Clamp Screw Зажимной винт	Altlık Shim Опорная пластина	Altlık Vidası Shim Screw Винт опорной пластины	Sekman Ring Кольцо	Pul Stamp Шайба	Anahtar Allen Key Ключ								
TCKNR/L 2020 K12	●	●	20	20	125	25																
2525 M12	●	●	25	25	150	32									CNM. 1204..	ATK-02	AKV-30-M6x22	AACN-3-0001	AAV-02-M5x12	AS-01	ABPL-01	AAL-03-3
3232 P12	●	●	32	32	170	40																
2525 M16	●	●	25	25	150	32	CNM. 1606..	ATK-04	AKV-19-M7x25	AACN-3-0002	AAV-05-M6x15	AS-02	ABPL-02	AAL-05-4								
3232 P16	●	●	32	32	170	40																

R: Sağ / Right / Правый L: Sol / Left / Левый

● Stokta / In Stock / В наличии ○ Stokta Yok / Non Stock Item / Нет в наличии

Sipariş Örneği/Ordering Example/Образец заказа

1 ad./pcs./шт. TCBNR 2525 M16

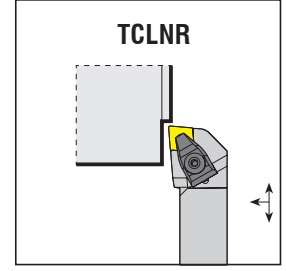
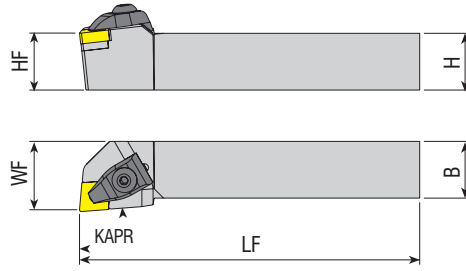

Takım Kodu Ordering Code Код для заказа	Stok Stock Наличие		Takım Ölçüleri (mm) Dimension (mm) Размеры (мм)				Kesici Uç Insert Пластина	Yedek Parçaları / Spare Parts / Запасные части								
	R	L	HF=H	B	LF	WF		Baskı Pabucu Wedge Clamp Прижим	Pabuç Vidası Clamp Screw Зажимной винт	Altlık Shim Опорная пластина	Altlık Vidası Shim Screw Винт опорной пластины	Sekman Ring Кольцо	Pul Stamp Шайба	Anahtar Allen Key Ключ		
TCLNR/L 2020 K12	●	●	20	20	125	25	CNM. 1204..									
2525 M12	●	●	25	25	150	32										
3232 P12	●	●	32	32	170	40										
4040 S12	●	●	40	40	250	50										
5050 S12	●	●	50	50	250	63	CNM. 1606..									
2525 M16	●	●	25	25	150	32										
3232 P16	●	●	32	32	170	40										

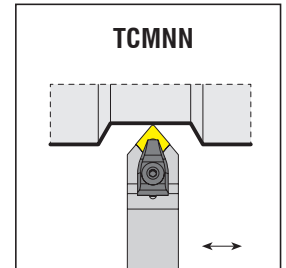
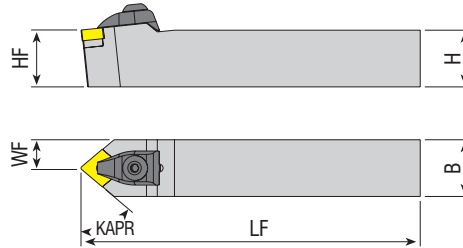

Takım Kodu Ordering Code Код для заказа	Stok Stock Наличие		Takım Ölçüleri (mm) Dimension (mm) Размеры (мм)				Kesici Uç Insert Пластина	Yedek Parçaları / Spare Parts / Запасные части								
	R	L	HF=H	B	LF	WF		Baskı Pabucu Wedge Clamp Прижим	Pabuç Vidası Clamp Screw Зажимной винт	Altlık Shim Опорная пластина	Altlık Vidası Shim Screw Винт опорной пластины	Sekman Ring Кольцо	Pul Stamp Шайба	Anahtar Allen Key Ключ		
TCMNN 1616 H12	●		16	16	100	8	CNM. 1204..									
2020 K12	●		20	20	125	10										
2525 M12	●		25	25	150	12.5										
3232 P12	●		32	32	170	16										
2525 M16	●		25	25	150	12.5	CNM. 1606..									
3232 P16	●		32	32	170	16										
4040 S16	○		40	40	250	20										

R: Sağ / Right / Правый L: Sol / Left / Левый
● Stokta / In Stock / В наличии ○ Stokta Yok / Non Stock Item / Нет в наличии

Sipariş Örneği/Ordering Example/Образец заказа
1 ad./pcs./шт. TCLNR 2020 K12

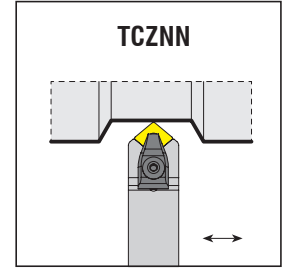
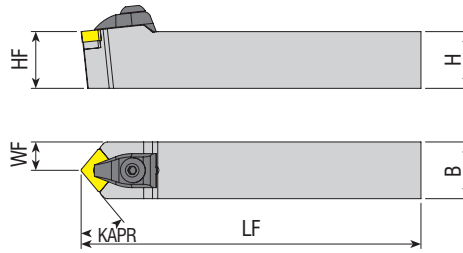
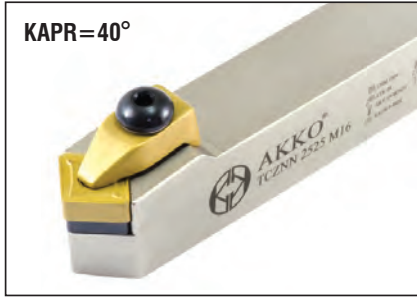

Takım Kodu Ordering Code Код для заказа	Stok Stock Наличие		Takım Ölçüleri (mm) Dimension (mm) Размеры (мм)				Kesici Uç Insert Пластина	Yedek Parçaları / Spare Parts / Запасные части														
	R	L	HF=H	B	LF	WF		Baskı Pabucu Wedge Clamp Прижим	Pabuç Vidası Clamp Screw Зажимной винт	Aitlik Shim Опорная пластина	Aitlik Vidası Shim Screw Винт опорной пластины	Sekman Ring Кольцо	Pul Stamp Шайба	Anahtar Allen Key Ключ								
TCZNN 2020 K12	●		20	20	125	10																
2525 M12	●		25	25	150	12.5									CNM. 1204..	ATK-02	AKV-30-M6x22	AACN-3-0001	AAV-02-M5x12	AS-01	ABPL-01	AAL-03-3
3232 P12	●		32	32	170	16																
2525 M16	●		25	25	150	12.5	CNM. 1606..															
3232 P16	●		32	32	170	16																

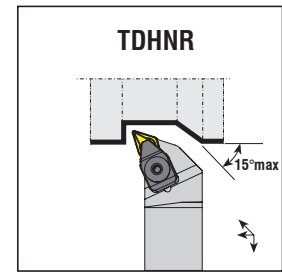
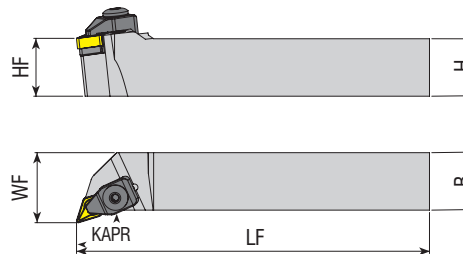

Takım Kodu Ordering Code Код для заказа	Stok Stock Наличие		Takım Ölçüleri (mm) Dimension (mm) Размеры (мм)				Kesici Uç Insert Пластина	Yedek Parçaları / Spare Parts / Запасные части								
	R	L	HF=H	B	LF	WF		Baskı Pabucu Wedge Clamp Прижим	Pabuç Vidası Clamp Screw Зажимной винт	Aitlik Shim Опорная пластина	Aitlik Vidası Shim Screw Винт опорной пластины	Sekman Ring Кольцо	Pul Stamp Шайба	Anahtar Allen Key Ключ		
TDHNR/L 2525 M11	○	●	25	25	150	31										
2020 K15	●	●	20	20	125	25									DNM. 1104..	ATK-01
2525 M15	●	●	25	25	150	32	DNM. 1506..									
3232 P15	●	●	32	32	170	40										

R: Sağ / Right / Правый L: Sol / Left / Левый
● Stokta / In Stock / В наличии ○ Stokta Yok / Non Stock Item / Нет в наличии

Sipariş Örneği/Ordering Example/Образец заказа
1 ad./pcs./шт. TCZNN 2020 K12

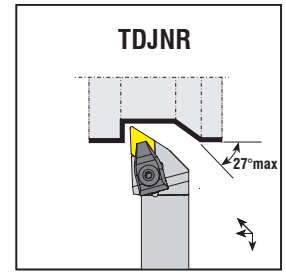
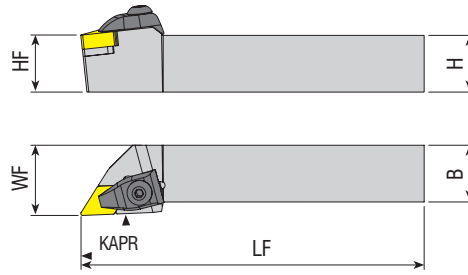

Takım Kodu Ordering Code Код для заказа	Stok Stock Наличие		Takım Ölçüleri (mm) Dimension (mm) Размеры (мм)				Kesici Uç Insert Пластина	Yedek Parçaları / Spare Parts / Запасные части								
	R	L	HF=H	B	LF	WF		Baskı Pabuçu Wedge Clamp Прижим	Pabuç Vidası Clamp Screw Закрепительный винт	Altlık Shim Опорная пластина	Altlık Vidası Shim Screw Винт опорной пластины	Sekman Ring Кольцо	Pul Stamp Шайба	Anahtar Allen Key Ключ		
TDJNR/L 1616 H11	●	●	16	16	100	20	DNM. 1104..					-				
2020 K11	●	●	20	20	125	25										
2525 M11	●	●	25	25	150	32										
2020 K15	●	●	20	20	125	25	DNM. 1506..					AS-01				
2525 M15	●	●	25	25	150	32										
3232 P15	●	●	32	32	170	40										
4040 S15	●	●	40	40	250	50										
5050 S15	○	○	50	50	250	63										
2020 K1504	●	●	20	20	125	25	DNM. 1504..					AS-01				
2525 M1504	●	●	25	25	150	32										
3232 P1504	●	●	32	32	170	40										
4040 S1504	●	●	40	40	250	50										

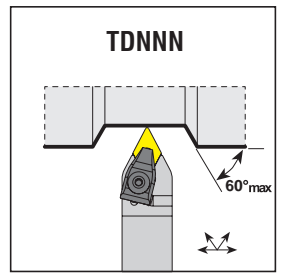
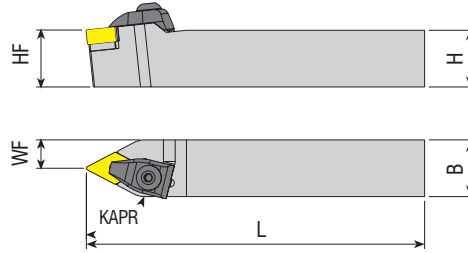

Takım Kodu Ordering Code Код для заказа	Stok Stock Наличие		Takım Ölçüleri (mm) Dimension (mm) Размеры (мм)				Kesici Uç Insert Пластина	Yedek Parçaları / Spare Parts / Запасные части								
	R	L	HF=H	B	LF	WF		Baskı Pabuçu Wedge Clamp Прижим	Pabuç Vidası Clamp Screw Закрепительный винт	Altlık Shim Опорная пластина	Altlık Vidası Shim Screw Винт опорной пластины	Sekman Ring Кольцо	Pul Stamp Шайба	Anahtar Allen Key Ключ		
TDNNN 1616 H11	●	●	16	16	100	8	DNM. 1104..					-				
2020 K11	●	●	20	20	125	10										
2525 M11	●	●	25	25	150	12.5										
2020 K15	●	●	20	20	125	10	DNM. 1506..					AS-01				
2525 M15	●	●	25	25	150	12.5										
3232 P15	●	●	32	32	170	16										
4040 S15	○	○	40	40	250	20										
5050 S15	○	○	50	50	250	25										

R: Sağ / Right / Правый L: Sol / Left / Левый
● Stokta / In Stock / В наличии ○ Stokta Yok / Non Stock Item / Нет в наличии

Sipariş Örneği/Ordering Example/Образец заказа
1 ad./pcs./шт. TDJNR 1616 H11

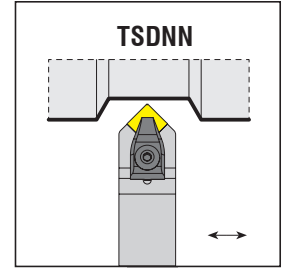
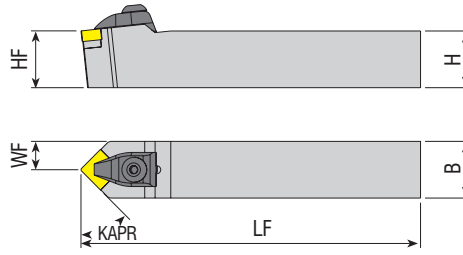

Takım Kodu Ordering Code Код для заказа	Stok Stock Наличие		Takım Ölçüleri (mm) Dimension (mm) Размеры (мм)				Kesici Uç Insert Пластина	Yedek Parçaları / Spare Parts / Запасные части						
	R	L	HF=H	B	LF	WF		Baskı Pabuçu Wedge Clamp Прижим	Pabuç Vidası Clamp Screw Зажимной винт	Altlık Shim Опорная пластина	Altlık Vidası Shim Screw Винт опорной пластины	Sekman Ring Кольцо	Pul Stamp Шайба	Anahtar Allen Key Ключ
TSDNN 1616 H12	●		16	16	100	8	SNM. 1204..							
2020 K12	●		20	20	125	10								
2525 M12	●		25	25	150	12.5								
3232 P12	●		32	32	170	16								
2525 M15	○		25	25	150	12.5	SNM. 1506..							
3232 P15	●		32	32	170	16								
4040 S15	○		40	40	250	20								

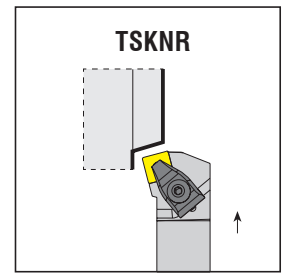
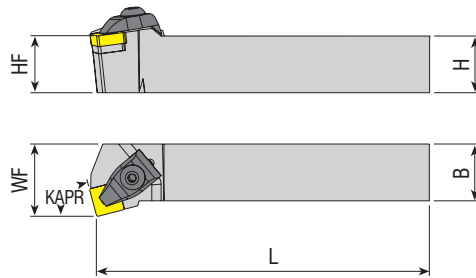

Takım Kodu Ordering Code Код для заказа	Stok Stock Наличие		Takım Ölçüleri (mm) Dimension (mm) Размеры (мм)				Kesici Uç Insert Пластина	Yedek Parçaları / Spare Parts / Запасные части						
	R	L	HF=H	B	LF	WF		Baskı Pabuçu Wedge Clamp Прижим	Pabuç Vidası Clamp Screw Зажимной винт	Altlık Shim Опорная пластина	Altlık Vidası Shim Screw Винт опорной пластины	Sekman Ring Кольцо	Pul Stamp Шайба	Anahtar Allen Key Ключ
TSKNR/L 2020 K12	●	●	20	20	125	25	SNM. 1204..							
2525 M12	●	●	25	25	150	32								
3232 P12	●	●	32	32	170	40								
3232 P15	●	●	32	32	170	40	SNM. 1506..							

R: Sağ / Right / Правый L: Sol / Left / Левый

● Stokta / In Stock / В наличии ○ Stokta Yok / Non Stock Item / Нет в наличии

Sipariş Örneği/Ordering Example/Образец заказа

1 ad./pcs./шт. TSDNN 1616 H12

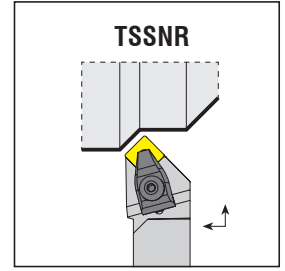
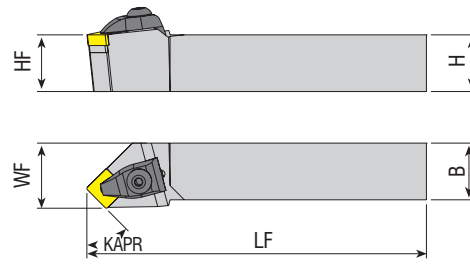

Takım Kodu Ordering Code Код для заказа	Stok Stock Наличие		Takım Ölçüleri (mm) Dimension (mm) Размеры (мм)				Kesici Uç Insert Пластина	Yedek Parçaları / Spare Parts / Запасные части												
	R	L	HF=H	B	LF	WF		Baskı Pabucu Wedge Clamp Прижим	Pabuç Vidası Clamp Screw Зажимной винт	Altlık Shim Опорная пластина	Altlık Vidası Shim Screw Винт опорной пластины	Sekman Ring Кольцо	Pul Stamp Шайба	Anahtar Allen Key Ключ						
TSSNR/L 2020 K12	●	●	20	20	125	25	SNM. 1204..													
2525 M12	●	●	25	25	150	32									AKV-30-M6x22	AASN-3-0004	AAV-02-M5x12	AS-01	ABPL-01	AAL-03-3
3232 P12	●	●	32	32	170	40														
2525 M15	●	●	25	25	150	32	SNM. 1506..													
3232 P15	●	●	32	32	170	40									AKV-19-M7x25	AASN-3-0023	AAV-05-M6x15	AS-02	ABPL-02	AAL-05-4

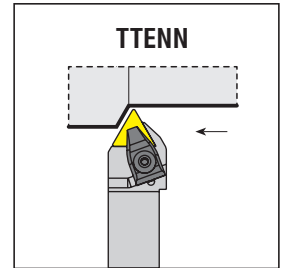
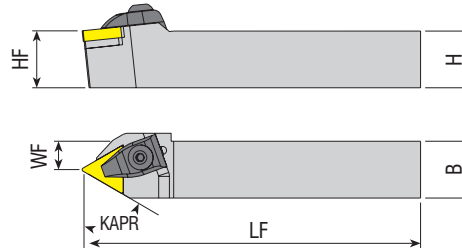

Takım Kodu Ordering Code Код для заказа	Stok Stock Наличие		Takım Ölçüleri (mm) Dimension (mm) Размеры (мм)				Kesici Uç Insert Пластина	Yedek Parçaları / Spare Parts / Запасные части													
			HF=H	B	LF	WF		Baskı Pabucu Wedge Clamp Прижим	Pabuç Vidası Clamp Screw Зажимной винт	Altlık Shim Опорная пластина	Altlık Vidası Shim Screw Винт опорной пластины	Sekman Ring Кольцо	Pul Stamp Шайба	Anahtar Allen Key Ключ							
TTENN 2020 K16	●		20	20	125	10	TNM. 1604..														
2525 M16	●		25	25	150	12.5									AKV-01-M5x22	AATN-2-0002	AAV-03-M5x12	-			
3232 P16	●		32	32	170	16															
2525 M22	●		25	25	150	12.5	TNM. 2204..														
3232 P22	●		32	32	170	16									AKV-30-M6x22	AATN-3-0015	AAV-02-M5x12	AS-01			
4040 S22	○		40	40	250	20															

R: Sağ / Right / Правый L: Sol / Left / Левый

● Stokta / In Stock / В наличии ○ Stokta Yok / Non Stock Item / Нет в наличии

Sipariş Örneği/Ordering Example/Образец заказа
1 ad./pcs./шт. TSSNR 2020 K12

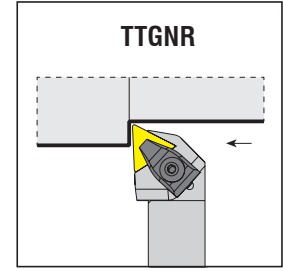
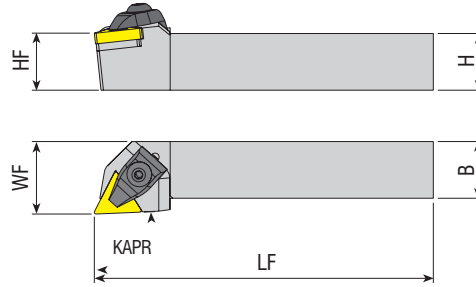
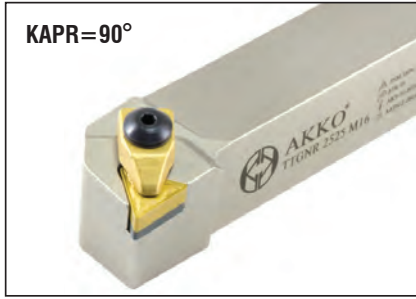

Takım Kodu Ordering Code Код для заказа	Stok Stock Наличие		Takım Ölçüleri (mm) Dimension (mm) Размеры (мм)				Yedek Parçaları / Spare Parts / Запасные части								
	R	L	HF=H	B	LF	WF	Kesici Uç Insert Пластина	Baskı Pabuçu Wedge Clamp Прижим	Pabuç Vidası Clamp Screw Зажимной винт	Altlık Shim Опорная пластина	Altlık Vidası Shim Screw Винт опорной пластины	Sekman Ring Кольцо	Pul Stamp Шайба	Anahtar Allen Key Ключ	
	●	○													
TTGNR/L 2020 K16	●	●	20	20	125	25	TNM. 1604..		AKV-01-M5x22	AATN-2-0002	AAV-03-M5x12	-	ABPL-01	AAL-03-3	
2525 M16	●	●	25	25	150	32									
3232 P16	●	●	32	32	170	40									
2525 M22	●	●	25	25	150	32	TNM. 2204..		AKV-30-M6x22	AATN-3-0015	AAV-02-M5x12	AS-01	ABPL-01	AAL-03-3	
3232 P22	●	●	32	32	170	40									
4040 S22	○	○	40	40	250	50									

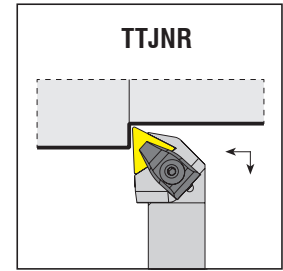
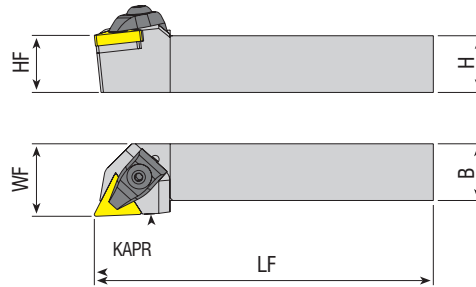
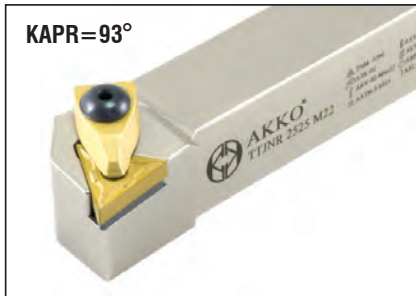

Takım Kodu Ordering Code Код для заказа	Stok Stock Наличие		Takım Ölçüleri (mm) Dimension (mm) Размеры (мм)				Yedek Parçaları / Spare Parts / Запасные части								
	R	L	HF=H	B	LF	WF	Kesici Uç Insert Пластина	Baskı Pabuçu Wedge Clamp Прижим	Pabuç Vidası Clamp Screw Зажимной винт	Altlık Shim Опорная пластина	Altlık Vidası Shim Screw Винт опорной пластины	Sekman Ring Кольцо	Pul Stamp Шайба	Anahtar Allen Key Ключ	
	●	○													
TTJNR/L 2020 K16	●	●	20	20	125	25	TNM. 1604..		AKV-01-M5x22	AATN-2-0002	AAV-03-M5x12	-	ABPL-01	AAL-03-3	
2525 M16	●	●	25	25	150	32									
3232 P16	●	●	32	32	170	40									
2525 M22	●	●	25	25	150	32	TNM. 2204..		AKV-30-M6x22	AATN-3-0015	AAV-02-M5x12	AS-01	ABPL-01	AAL-03-3	
3232 P22	●	●	32	32	170	40									
4040 S22	○	○	40	40	250	50									

R: Sağ / Right / Правый L: Sol / Left / Левый
● Stokta / In Stock / В наличии ○ Stokta Yok / Non Stock Item / Нет в наличии

Sipariş Örneği/Ordering Example/Образец заказа
1 ad./pcs./шт. TTGNR 2020 K16

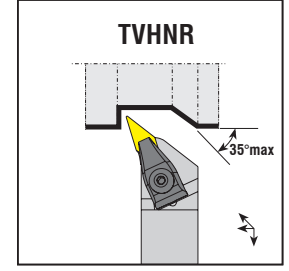
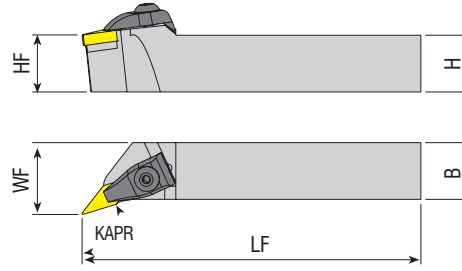

Takım Kodu Ordering Code Код для заказа	Stok Stock Наличие		Takım Ölçüleri (mm) Dimension (mm) Размеры (мм)				Kesici Uç Insert Пластина	Yedek Parçaları / Spare Parts / Запасные части						
	R	L	HF=H	B	LF	WF		Baskı Pabucu Wedge Clamp Прижим	Pabuç Vidası Clamp Screw Зажимной винт	Altlık Shim Опорная пластина	Altlık Vidası Shim Screw Винт опорной пластины	Sekman Ring Кольцо	Pul Stamp Шайба	Anahtar Allen Key Ключ
	●	●												
TVHNR/L 2020 K16	●	●	20	20	125	25	VNM. 1604..	ATK-03	AKV-30-M6x22	AAVN-2-0002	AAV-04-M5x12	AS-01	ABPL-01	AAL-03-3
2525 M16	●	●	25	25	150	32								
3232 P16	●	●	32	32	170	40								

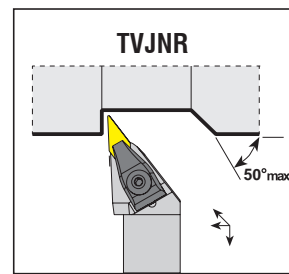
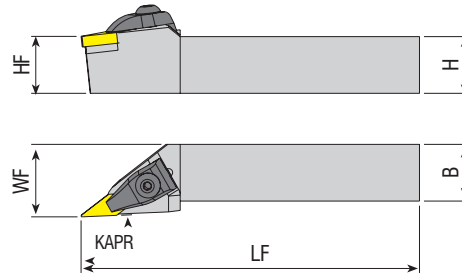

Takım Kodu Ordering Code Код для заказа	Stok Stock Наличие		Takım Ölçüleri (mm) Dimension (mm) Размеры (мм)				Kesici Uç Insert Пластина	Yedek Parçaları / Spare Parts / Запасные части						
	R	L	HF=H	B	LF	WF		Baskı Pabucu Wedge Clamp Прижим	Pabuç Vidası Clamp Screw Зажимной винт	Altlık Shim Опорная пластина	Altlık Vidası Shim Screw Винт опорной пластины	Sekman Ring Кольцо	Pul Stamp Шайба	Anahtar Allen Key Ключ
	●	●												
TVJNR/L 2020 K16	●	●	20	20	125	25	VNM. 1604..	ATK-03	AKV-30-M6x22	AAVN-2-0002	AAV-04-M5x12	AS-01	ABPL-01	AAL-03-3
2525 M16	●	●	25	25	150	32								
3232 P16	●	●	32	32	170	40								

R: Sağ / Right / Правый L: Sol / Left / Левый
● Stokta / In Stock / В наличии ○ Stokta Yok / Non Stock Item / Нет в наличии

Sipariş Örneği/Ordering Example/Образец заказа
1 ad./pcs./шт. TVHNR 2020 K16

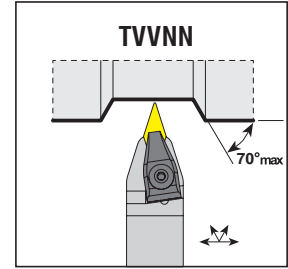
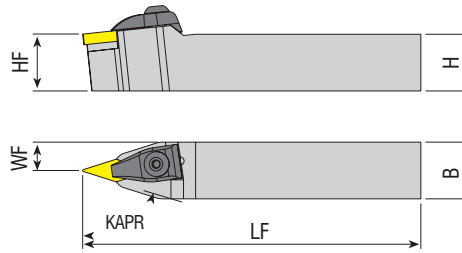

Takım Kodu Ordering Code Код для заказа	Stok Stock Наличие		Takım Ölçüleri (mm) Dimension (mm) Размеры (мм)				Kesici Uç Insert Пластина	Yedek Parçaları / Spare Parts / Запасные части						
	R	L	HF=H	B	LF	WF		Baskı Pabuçu Wedge Clamp Прижим	Pabuç Vidası Clamp Screw Закрепительный винт	Altılık Shim Опорная пластина	Altılık Vidası Shim Screw Винт опорной пластины	Sekman Ring Кольцо	Pul Stamp Шайба	Anahtar Allen Key Ключ
TVVNN 2020 K16	●		20	20	125	10	VNM. 1604..		AKV-30-M6x22	AAVN-2-0002	AAV-04-M5x12	AS-01	ABPL-01	AAL-03-3
2525 M16	●		25	25	150	12.5								
3232 P16	●		32	32	170	16								

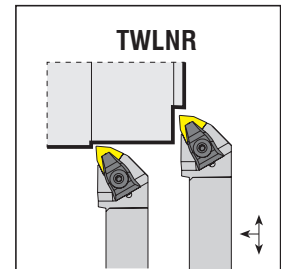
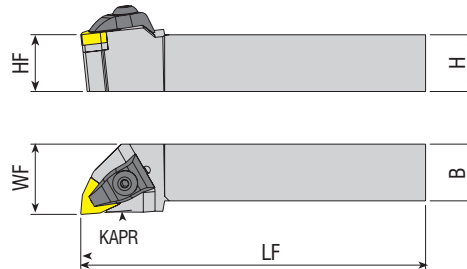

Takım Kodu Ordering Code Код для заказа	Stok Stock Наличие		Takım Ölçüleri (mm) Dimension (mm) Размеры (мм)				Kesici Uç Insert Пластина	Yedek Parçaları / Spare Parts / Запасные части						
	R	L	HF=H	B	LF	WF		Baskı Pabuçu Wedge Clamp Прижим	Pabuç Vidası Clamp Screw Закрепительный винт	Altılık Shim Опорная пластина	Altılık Vidası Shim Screw Винт опорной пластины	Sekman Ring Кольцо	Pul Stamp Шайба	Anahtar Allen Key Ключ
TWLNR/L 1616 H06	●	●	16	16	100	20	WNM. 0604..		AKV-01-M5x22	AAWN-SW317	AAV-01-M3x10	-	ABPL-01	AAL-03-3
2020 K06	●	●	20	20	125	25								
2525 M06	●	●	25	25	150	32								
2020 K08	●	●	20	20	125	25	WNM. 0804..		AKV-30-M6x22	AAWN-3-0001	AAV-02-M5x12	AS-01	ABPL-01	AAL-03-3
2525 M08	●	●	25	25	150	32								
3232 P08	●	●	32	32	170	40								
4040 S08	●	●	40	40	250	50								
5050 S08	○	○	50	50	250	63								

R: Sağ / Right / Правый L: Sol / Left / Левый
● Stokta / In Stock / В наличии ○ Stokta Yok / Non Stock Item / Нет в наличии

Sipariş Örneği/Ordering Example/Образец заказа
1 ad./pcs./шт. TVVNN 2020 K16



*konusulan
the spoken kalite...
quality...*

T-SİSTEM

T-SİSTEM İÇTEN SOĞUTMA KANALLI DIŞ TORNA KATERLERİ
T-SYSTEM EXTERNAL TURNING TOOLHOLDERS WITH COOLANT HOLE
T-ТИП ДЕРЖАВКИ ДЛЯ НАРУЖНОГО ТОЧЕНИЕ С ПОДВОДОМ СОЖ



DETAYLI BİLGİ İÇİN BARKODU OKUTUNUZ

SCAN ME FOR MORE DETAILS

ПРОСКАНИРУЙТЕ ДЛЯ ПОЛУЧЕНИЯ БОЛЕЕ ПОДРОБНОЙ ИНФОРМАЦИИ



KAPR=95°

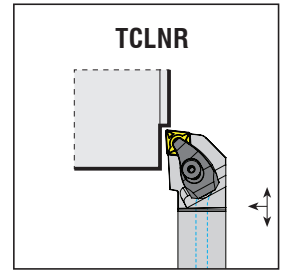
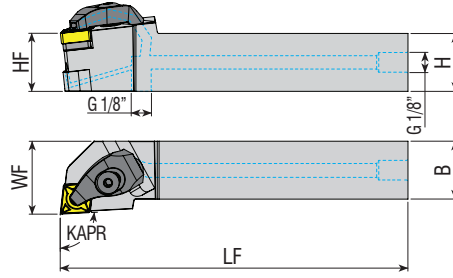
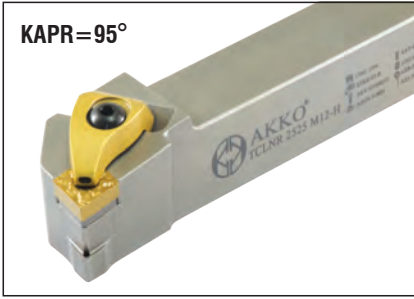

Takım Kodu
Ordering Code
Код для заказа

Stok Stock Наличие		Takım Ölçüleri (mm) Dimension (mm) Размеры (мм)				
R	L	HF=H	B	LF	WF	

TCLNR/L 2020 K12-H
2525 M12-H
3232 P12-H

●	●	20	20	125	25
●	●	25	25	150	32
●	●	32	32	170	40

Kesici Uç
Insert
Пластина



Baskı Pabucu
Wedge Clamp
Прижим



Pabuç Vidası
Clamp Screw
Закрепительный винт



Aitlik
Shim
Отверная пластина



Aitlik Vidası
Shim Screw
Винт отверной пластины



Yay
Spring
Пружина



Oring
Ring
Кольцо



Sızdırmaz Vida
Threaded Pin
Резьбовой Винт



Anahtar
Allen Key
Ключ



CNM. 1204..

ATKH-01-R
ATKH-02-L

AKV-33-M6x22

AACN-3-0001

AAV-13-M5x8

AKY-01

AXR-01

2705-G1/8x5.5

AAL-03-3



KAPR=93°

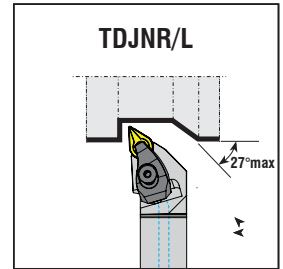
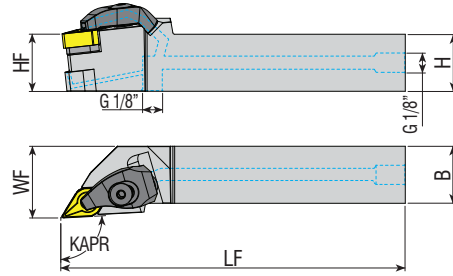

Takım Kodu
Ordering Code
Код для заказа

Stok Stock Наличие		Takım Ölçüleri (mm) Dimension (mm) Размеры (мм)				
R	L	HF=H	B	LF	WF	

TDJNR/L 2020 K15-H
2525 M15-H
3232 P15-H

●	●	20	20	125	25
●	●	25	25	150	32
●	●	32	32	170	40

Kesici Uç
Insert
Пластина



Baskı Pabucu
Wedge Clamp
Прижим



Pabuç Vidası
Clamp Screw
Закрепительный винт



Aitlik
Shim
Отверная пластина



Aitlik Vidası
Shim Screw
Винт отверной пластины



Yay
Spring
Пружина



Oring
Ring
Кольцо



Sızdırmaz Vida
Threaded Pin
Резьбовой Винт



Anahtar
Allen Key
Ключ



DNM. 1506..

ATKH-01-R
ATKH-02-L

AKV-33-M6x22

AADN-3-0001

AAV-13-M5x8

AKY-01

AXR-01

2705-G1/8x5.5

AAL-03-3

R: Sağ / Right / Правый L: Sol / Left / Левый

● Stokta / In Stock / В наличии ○ Stokta Yok / Non Stock Item / Нет в наличии

Sipariş Örneği/Ordering Example/Образец заказа

1 ad./pcs./шт. TCLNR 2020 K12-H

T-SİSTEM İÇTEN SOĞUTMA KANALLI DIŞ TORNA KATERLERİ
T-SYSTEM EXTERNAL TURNING TOOLHOLDERS WITH COOLANT HOLE
T-ТИП ДЕРЖАВКИ ДЛЯ НАРУЖНОГО ТОЧЕНИЕ С ПОДВОДОМ СОЖ

new

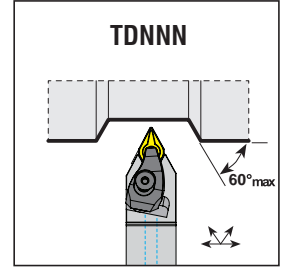
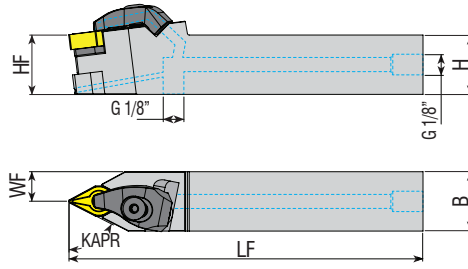

Takım Kodu Ordering Code Код для заказа	Stok Stock Наличие		Takım Ölçüleri (mm) Dimension (mm) Размеры (мм)				Kesici Uç Insert Пластина	Yedek Parçaları / Spare Parts / Запасные части								
	R	L	HF=H	B	LF	WF		Baskı Pabucu Wedge Clamp Прижим	Pabuç Vidası Clamp Screw Зажимный винт	Altlık Shim Оторная пластина	Altlık Vidası Shim Screw Винт оторной пластины	Yay Spring Пружина	Oring Ring Кольцо	Sızdırmaz Vida Threaded Pin Резьбовой Винт	Anahtar Allen Key Ключ	
TDNNN 2525 M15-H	●		25	25	150	32										

new

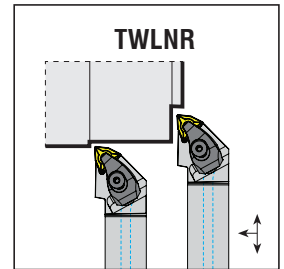
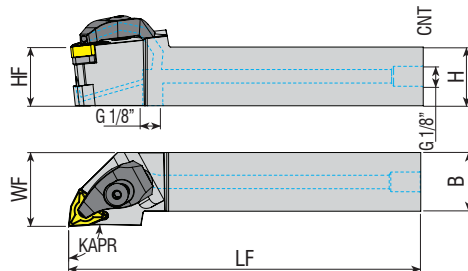

Takım Kodu Ordering Code Код для заказа	Stok Stock Наличие		Takım Ölçüleri (mm) Dimension (mm) Размеры (мм)				Kesici Uç Insert Пластина	Yedek Parçaları / Spare Parts / Запасные части																
	R	L	HF=H	B	LF	WF		Baskı Pabucu Wedge Clamp Прижим	Pabuç Vidası Clamp Screw Зажимный винт	Altlık Shim Оторная пластина	Altlık Vidası Shim Screw Винт оторной пластины	Yay Spring Пружина	Oring Ring Кольцо	Sızdırmaz Vida Threaded Pin Резьбовой Винт	Anahtar Allen Key Ключ									
TWLNR/L 2020 K08-H	●	●	20	20	125	25																		
2525 M08-H	●	●	25	25	150	32										WNN. 0804..	ATKH-01-R	AKV-33-M6x22	AAWN-3-0001	AAV-13-M5x8	AKY-01	AXR-01	2705-G1/8x5.5	AAL-03-3
3232 P08-H	●	●	32	32	170	40										ATKH-02-L								

R: Sağ / Right / Правый L: Sol / Left / Левый

● Stokta / In Stock / В наличии ○ Stokta Yok / Non Stock Item / Нет в наличии

Sipariş Örneği/Ordering Example/Образец заказа

1 ad./pcs./шт. TDNNN 2525 M15-H

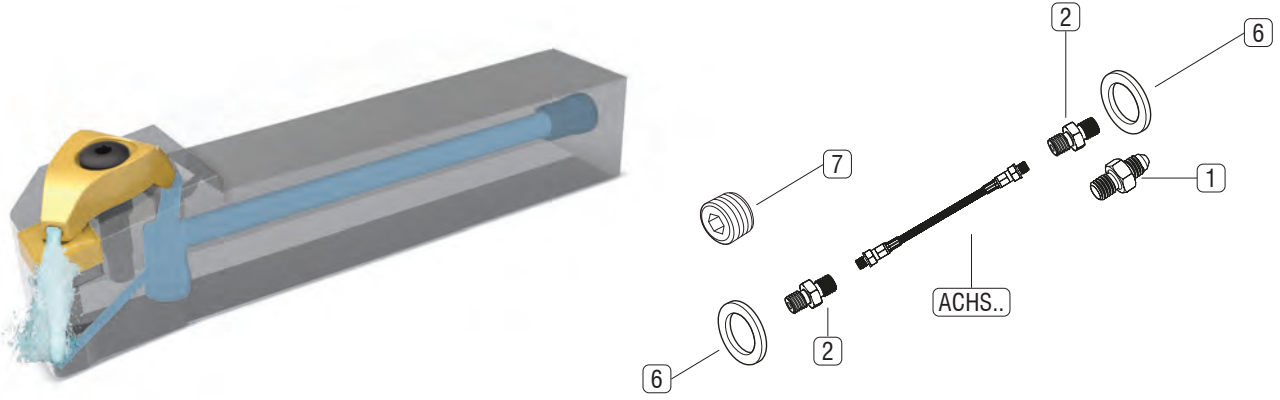

Not: İçten soğutmalı tüm torna katerlerinde kullanılabilir 3 tip soğutma hortum setleri tasarlanmıştır. Takımların kullanılmasından önce, kullanılmayan bağlantıların set içindeki vida ile kapatılarak sızdırmazlığın sağlanmasına dikkat edilmelidir. Torna katerlerine yönelik soğutma hortum setleri, ACHS... 10 bar ile maksimum 275 bar basınç aralığında kullanılabilir.

Note: 3 types of cooling hose sets are designed that can be used in all internally cooled lathes. Before using the tools, care should be taken to ensure that the unused connections are closed with the screw in the set and that sealing is ensured. Cooling hose sets for lathe tools can be used in the pressure range of ACHS ... 10 bar to max 275 bar.

Примечание: Предлагается 3 типа комплектов трубок для подвода СОЖ. Они могут использоваться на всех токарных станках оснащенных системой подвода СОЖ. Перед началом работ необходимо закрыть неиспользуемые соединения винтом из набора и обеспечить герметичность системы подвода СОЖ. Комплекты охлаждающих трубок, для токарных инструментов, могут использоваться в диапазоне давлений ACHS от 10 бар до 275 бар.

Set içindeki Parçalar Parts In The Set Запчасти в Наборе				Uzunluk / Length Code / Длина		
				Set Kodu: Set Code: Код Набора: ACHS-1-250	Set Kodu: Set Code: Код Набора: ACHS-2-250	Set Kodu: Set Code: Код Набора: ACHS-3-250
	Resim Picture Рисунок	Takım Kodu Set Code Код Набора	Ürün Açıklaması Product Description Описание товара			
1		AMP-01	M10 Bağlantı Elemanı M10 Fastener Застежка M10	1x	-	-
2		AMP-02	G 1/8" Çift Bağlantı Elemanı G 1/8" Double Fastener G 1/8" двойная застежка	2x	1x	-
3		AMP-03	G 1/8" Açılı Bağlantısı G 1/8" Angle Connection G 1/8" угловое соединение	-	1x	2x
4		AMP-04	M10" Açılı Bağlantısı M10" Angle Connection M10" угловое соединение	-	1x	1x
5		AMP-05	G1/4"-G1/8" Kılcalma Parçası G1 / 4"-G1/8" Capillary Piece G1 / 4"-G1/8" Капиллярная часть	-	1x	1x
6		AG-01	Bakır Conta Copper Gasket Медная прокладка	2x	3x	4x
7		2705-G1/8-5.5	G1/8" Sızdırmaz Civata G1/8" Sealing Bolt G1/8" Уплотнительный болт	1x	1x	1x
8		AH-1-250	Hortum Hose Трубка	1x	-	-
9		AH-2-250	Hortum Hose Трубка	-	1x	-
10		AH-3-250	Hortum Hose Трубка	-	-	1x



*konusulan
the spoken kalite...
quality...*

M-SİSTEM

M-SİSTEM DIŞ TORNA KATERLERİ
M-SYSTEM EXTERNAL TURNING TOOLHOLDERS
M-ТИП ДЕРЖАВКИ ДЛЯ НАРУЖНОГО ТОЧЕНИЯ



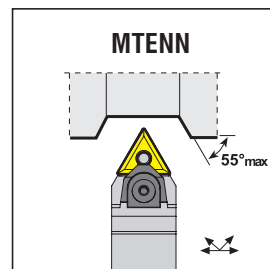
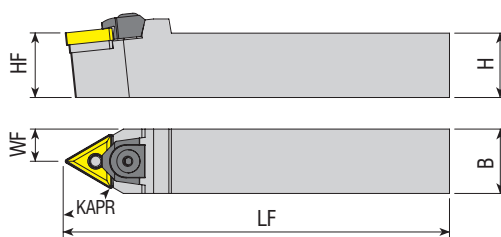

Takım Kodu Ordering Code Код для заказа	Stok Stock Наличие	Takım Ölçüleri (mm) Dimension (mm) Размеры (мм)				Kesici Uç Insert Пластина	Yedek Parçaları / Spare Parts / Запасные части						
		HF=H	B	LF	WF		Baskı Pabuçu Wedge Clamp Прижим	Pabuç Vidası Clamp Screw Закрепительный винт	Altlık Shim Опорная пластина	Pim Pin Штифт	Sekman Ring Кольцо	Pul Stamp Шайба	Anahtar Allen Key Ключ
MTENN 2020 K16	●	20	20	125	10	TNM. 1604..	AMK-04	AKV-30-M6x22	AATN-2-0002	APM-01	AS-01	ABPL-01	AAL-03-3
2525 M16	●	25	25	150	12.5								
3232 P16	●	32	32	170	16								
2525 M22	●	25	25	150	12.5	TNM. 2204..	AMK-08	AKV-30-M6x22	AATN-3-0015	APM-02	AS-01	ABPL-01	AAL-03-3
3232 P22	●	32	32	170	16								
4040 S22	●	40	40	250	20								

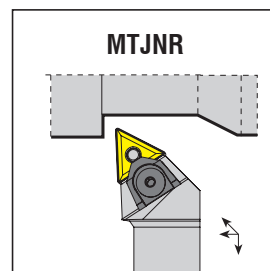
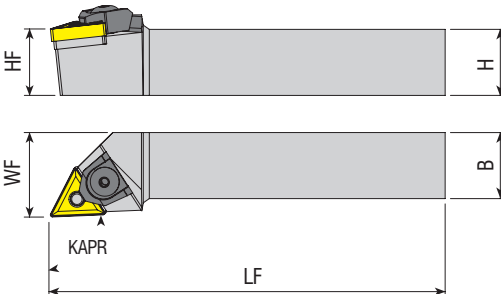
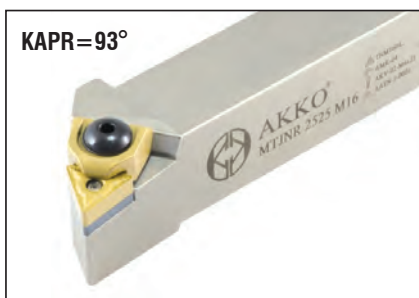

Takım Kodu Ordering Code Код для заказа	Stok Stock Наличие		Takım Ölçüleri (mm) Dimension (mm) Размеры (мм)				Kesici Uç Insert Пластина	Yedek Parçaları / Spare Parts / Запасные части						
	R	L	HF=H	B	LF	WF		Baskı Pabuçu Wedge Clamp Прижим	Pabuç Vidası Clamp Screw Закрепительный винт	Altlık Shim Опорная пластина	Pim Pin Штифт	Sekman Ring Кольцо	Pul Stamp Шайба	Anahtar Allen Key Ключ
MTJNR/L 2020 K16	●	●	20	20	125	25	TNM. 1604..	AMK-04	AKV-30-M6x22	AATN-2-0002	APM-01	AS-01	ABPL-01	AAL-03-3
2525 M16	●	●	25	25	150	32								
3232 P16	●	●	32	32	170	40								
2525 M22	●	●	25	25	150	32	TNM. 2204..	AMK-08	AKV-30-M6x22	AATN-3-0015	APM-02	AS-01	ABPL-01	AAL-03-3
3232 P22	●	●	32	32	170	40								
4040 S22	●	●	40	40	250	50								

R: Sağ / Right / Правый L: Sol / Left / Левый
● Stokta / In Stock / В наличии ○ Stokta Yok / Non Stock Item / Нет в наличии

Sipariş Örneği/Ordering Example/Образец заказа
1 ad./pcs./шт. MTENN 2020 K16

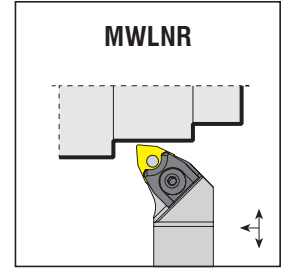
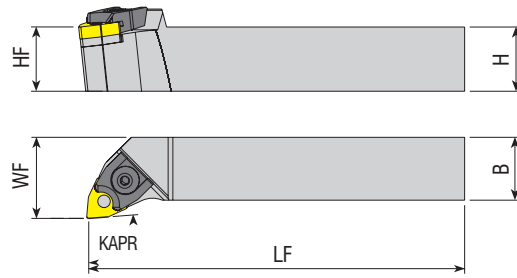

Takım Kodu Ordering Code Код для заказа	Stok Stock Наличие		Takım Ölçüleri (mm) Dimension (mm) Размеры (мм)				Kesici Uç Insert Пластина	Yedek Parçaları / Spare Parts / Запасные части						
	R	L	HF=H	B	LF	WF		Baskı Pabuçu Wedge Clamp Прижим	Pabuç Vidası Clamp Screw Зажимной винт	Altık Shim Опорная пластина	Pim Pin Штифт	Sekman Ring Кольцо	Pul Stamp Шайба	Anahtar Allen Key Ключ
MWLNR/L 1616 H06	●	●	16	16	100	20	WNM. 0604..	AMK-01	AKV-04-M5x17	-	APM-08	-	-	AAL-03-3
2020 K06	●	●	20	20	125	25								
2525 M06	●	●	25	25	150	32								
2020 K08	●	●	20	20	125	25	WNM. 0804..	AMK-05	AKV-03-M6x22	AAWN-3-0001	APM-02	AS-01	ABPL-01	AAL-03-3
2525 M08	●	●	25	25	150	32								
3232 P08	●	●	32	32	170	40								

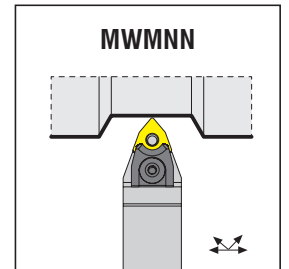
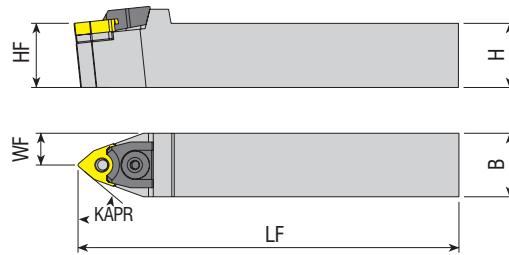

Takım Kodu Ordering Code Код для заказа	Stok Stock Наличие		Takım Ölçüleri (mm) Dimension (mm) Размеры (мм)				Kesici Uç Insert Пластина	Yedek Parçaları / Spare Parts / Запасные части						
	R	L	HF=H	B	LF	WF		Baskı Pabuçu Wedge Clamp Прижим	Pabuç Vidası Clamp Screw Зажимной винт	Altık Shim Опорная пластина	Pim Pin Штифт	Sekman Ring Кольцо	Pul Stamp Шайба	Anahtar Allen Key Ключ
MWMNN 1616 H06	●	●	16	16	100	8	WNM. 0604..	AMK-01	AKV-04-M5x17	-	APM-08	-	-	AAL-03-3
2020 K06	●	●	20	20	125	10								
2525 M06	●	●	25	25	150	12.5								
2020 K08	●	●	20	20	125	10	WNM. 0804..	AMK-05	AKV-03-M6x22	AAWN-3-0001	APM-02	AS-01	ABPL-01	AAL-03-3
2525 M08	●	●	25	25	150	12.5								
3232 P08	●	●	32	32	170	16								

R: Sağ / Right / Правый L: Sol / Left / Левый

● Stokta / In Stock / В наличии ○ Stokta Yok / Non Stock Item / Нет в наличии

Sipariş Örneği/Ordering Example/Образец заказа

1 ad./pcs./шт. MWLNR 1616 H06

P-SİSTEM

P-SİSTEM DIŞ TORNA KATERLERİ
P-SYSTEM EXTERNAL TURNING TOOLHOLDERS
P-ТИП ДЕРЖАВКИ ДЛЯ НАРУЖНОГО ТОЧЕНИЯ

*konusulan
the spoken kalite...
quality...*



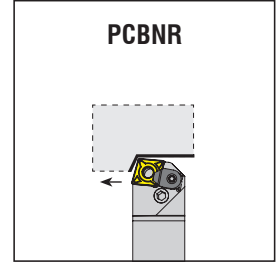
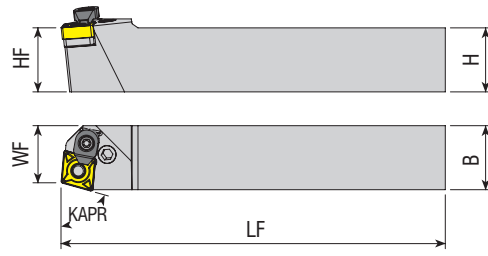

Takım Kodu
Ordering Code
Код для заказа

Stok
Stock
Наличие

Takım Ölçüleri (mm)
Dimension (mm)
Размеры (мм)

Kesici Uç
Insert
Пластина

Yedek Parçaları / Spare Parts / Запасные части

Levyeye
Lever
Рычаг

Levyeye Vidası
Lever Screw
Винт рычага

Aitlik
Shim
Опорная пластина

Aitlik Yayı
Shim Spring
Втулка рычага

Baskı Parçası
Wedge Clamp
Прижим

Baskı Vidası
Clamp Screw
Зажимной винт

Anahtar
Allen Key
Ключ

R

L

HF=H

B

LF

WF



Takım Kodu Ordering Code Код для заказа	R	L	HF=H	B	LF	WF
PCBNR/L 2020 K12C	●	●	20	20	125	17.5
2525 M12C	●	●	25	25	150	22.5
3232 P12C	●	●	32	32	170	29.5
2525 M16C	●	●	25	25	150	22
3232 P16C	●	●	32	32	170	27
3232 P19C	●	●	32	32	170	27
4040 S19C	●	●	40	40	250	37
4040 S25C	●	●	40	40	250	37
5050 S25C	○	○	50	50	250	47

Kesici Uç Insert Пластина	Levyeye Lever Рычаг	Levyeye Vidası Lever Screw Винт рычага	Aitlik Shim Опорная пластина	Aitlik Yayı Shim Spring Втулка рычага	Baskı Parçası Wedge Clamp Прижим	Baskı Vidası Clamp Screw Зажимной винт	Anahtar Allen Key Ключ
CNM. 1204..	APL-02	ALV-03-M8x19	AACN-3-0001	AAAY-02	ACK-05	4015-M4x11	AAL-03-3
CNM. 1606..	APL-04	ALV-04-M8x22	AACN-3-0002	AAAY-03			
CNM. 1906..	APL-05	ALV-05-M10x27	AACN-3-0003	AAAY-04	ACK-09	AAV-05-M6x15	AAL-05-4
CNM. 2509..	APL-06	ALV-06-M12x36	AACN-3-0008	AAAY-05	ACK-04	AKV-16-M6x16	AAL-07-5

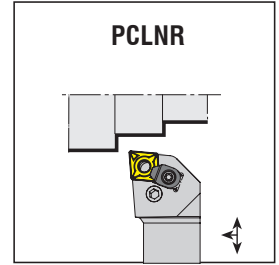
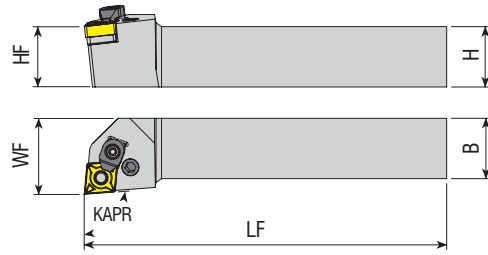

Takım Kodu
Ordering Code
Код для заказа

Stok
Stock
Наличие

Takım Ölçüleri (mm)
Dimension (mm)
Размеры (мм)

Kesici Uç
Insert
Пластина

Yedek Parçaları / Spare Parts / Запасные части

Levyeye
Lever
Рычаг

Levyeye Vidası
Lever Screw
Винт рычага

Aitlik
Shim
Опорная пластина

Aitlik Yayı
Shim Spring
Втулка рычага

Baskı Parçası
Wedge Clamp
Прижим

Baskı Vidası
Clamp Screw
Зажимной винт

Anahtar
Allen Key
Ключ

R

L

HF=H

B

LF

WF



Takım Kodu Ordering Code Код для заказа	R	L	HF=H	B	LF	WF
PCLNR/L 1616 H09	●	●	16	16	100	20
2020 K09	●	●	20	20	125	25
2525 M09	●	●	25	25	150	32
1616 H12	●	●	16	16	100	20
2020 K12C	●	●	20	20	125	25
2525 M12C	●	●	25	25	150	32
3232 P12C	●	●	32	32	170	40
2525 M16C	●	●	25	25	150	32
3232 P16C	●	●	32	32	170	40
2525 M19C	●	●	25	25	150	32
3232 P19C	●	●	32	32	170	40
4040 S19C	●	●	40	40	250	50
4040 S25C	●	●	40	40	250	50
5050 S25C	●	●	50	50	250	60

Kesici Uç Insert Пластина	Levyeye Lever Рычаг	Levyeye Vidası Lever Screw Винт рычага	Aitlik Shim Опорная пластина	Aitlik Yayı Shim Spring Втулка рычага	Baskı Parçası Wedge Clamp Прижим	Baskı Vidası Clamp Screw Зажимной винт	Anahtar Allen Key Ключ
CNM. 0903..	APL-01	ALV-02-M6x17	AACN-2-0002	AAAY-01	-	-	AAL-02-2.5
CNM. 1204..	APL-02	ALV-03-M8x19	AACN-3-0001	AAAY-02	ACK-05	4015-M4x11	AAL-03-3
CNM. 1606..	APL-04	ALV-04-M8x22	AACN-3-0002	AAAY-03			
CNM. 1906..	APL-05	ALV-05-M10x27	AACN-3-0003	AAAY-04	ACK-09	AAV-05-M6x15	AAL-05-4
CNM. 2509..	APL-06	ALV-06-M12x36	AACN-3-0008	AAAY-05	ACK-04	AKV-16-M6x16	AAL-07-5

R: Sağ / Right / Правый L: Sol / Left / Левый
● Stokta / In Stock / В наличии ○ Stokta Yok / Non Stock Item / Нет в наличии

Sipariş Örneği/Ordering Example/Образец заказа
1 ad./pcs./шт. PCBNR 2020 K12C

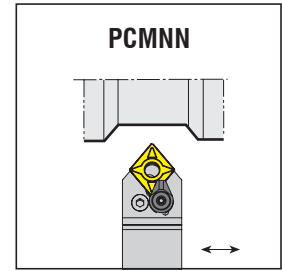
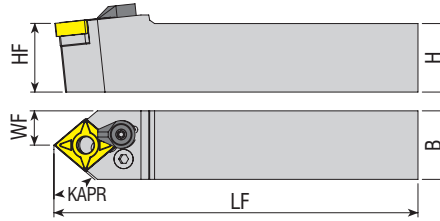

Takım Kodu Ordering Code Код для заказа	Stok Stock Наличие		Takım Ölçüleri (mm) Dimension (mm) Размеры (мм)				Kesici Uç Insert Пластина	Yedek Parçaları / Spare Parts / Запасные части						
	R	L	HF=H	B	LF	WF		Levyeye Lever Рычаг	Levyeye Vidası Lever Screw Винт рычага	Altılık Shim Опорная пластина	Altılık Yay Shim Spring Втулка рычага	Baskı Parçası Wedge Clamp Прижим	Baskı Vidası Clamp Screw Зажимной винт	Anahtar Allen Key Ключ
PCMN 2020 K12C	●		20	20	125	10	CNM. 1204..							
2525 M12C	●		25	25	150	12.5								
3232 P12C	○		32	32	170	16								
2525 M16C	○		25	25	150	12.5								
3232 P16C	○		32	32	170	16								
3232 P19C	●		32	32	170	16								
4040 S19C	●		40	40	250	20								
5050 S19C	○		50	50	250	25								
4040 S25C	●		40	40	250	20	CNM. 2509..							

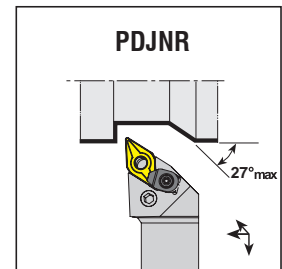
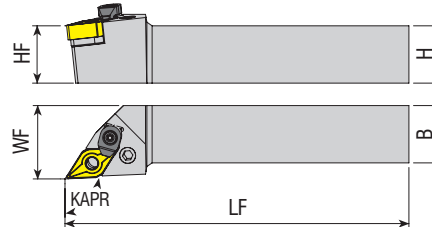

Takım Kodu Ordering Code Код для заказа	Stok Stock Наличие		Takım Ölçüleri (mm) Dimension (mm) Размеры (мм)				Kesici Uç Insert Пластина	Yedek Parçaları / Spare Parts / Запасные части						
	R	L	HF=H	B	LF	WF		Levyeye Lever Рычаг	Levyeye Vidası Lever Screw Винт рычага	Altılık Shim Опорная пластина	Altılık Yay Shim Spring Втулка рычага	Baskı Parçası Wedge Clamp Прижим	Baskı Vidası Clamp Screw Зажимной винт	Anahtar Allen Key Ключ
PDJNR/L 1616 H11	●	●	16	16	100	20	DNM. 1104..							
2020 K11	●	●	20	20	125	25								
2525 M11	●	●	25	25	150	32								
2020 K15C	●	●	20	20	125	25								
2525 M15C	●	●	25	25	150	32	DNM. 1506..							
3232 P15C	●	●	32	32	170	40								
4040 S15C	●	●	40	40	250	50								

R: Sağ / Right / Правый L: Sol / Left / Левый

● Stokta / In Stock / В наличии ○ Stokta Yok / Non Stock Item / Нет в наличии

Sipariş Örneği/Ordering Example/Образец заказа

1 ad./pcs./шт. PCMN 2020 K12C

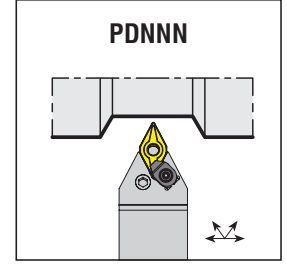
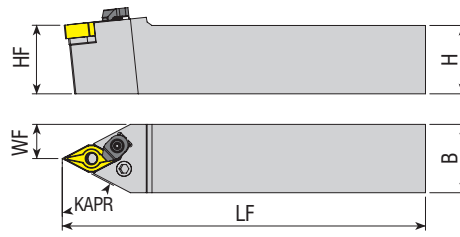

Takım Kodu Ordering Code Код для заказа	Stok Stock Наличие	Takım Ölçüleri (mm) Dimension (mm) Размеры (мм)				Kesici Uç Insert Пластина	Yedek Parçaları / Spare Parts / Запасные части							
		HF=H	B	LF	WF		Levye Lever Рычаг	Levye Vidası Lever Screw Винт рычага	Altlık Shim Опорная пластина	Altlık Yayı Shim Spring Втулка рычага	Baskı Parçası Wedge Clamp Прижим	Baskı Vidası Clamp Screw Зажимной винт	Anahtar Allen Key Ключ	
PDNNN 1616 H11	●	16	16	100	8									
2020 K11	●	20	20	125	10	DNM. 1104..	APL-01	ALV-02-M6x17	AADN-SD317	AAY-01	-	-	AAL-02-2.5	
2525 M11	●	25	25	150	12.5									
2020 K15C	●	20	20	125	10									
2525 M15C	●	25	25	150	12.5	DNM. 1506..	APL-03	ALV-03-M8x19	AADN-3-0001	AAY-02	ACK-05	4015-M4x11	AAL-03-3	
3232 P15C	●	32	32	170	16									

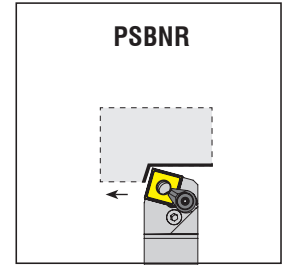
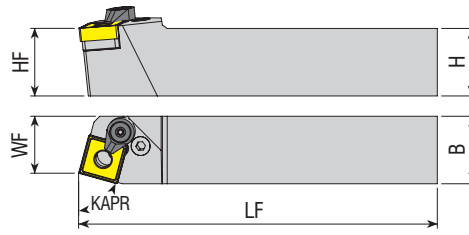

Takım Kodu Ordering Code Код для заказа	Stok Stock Наличие		Takım Ölçüleri (mm) Dimension (mm) Размеры (мм)				Kesici Uç Insert Пластина	Yedek Parçaları / Spare Parts / Запасные части							
	R	L	HF=H	B	LF	WF		Levye Lever Рычаг	Levye Vidası Lever Screw Винт рычага	Altlık Shim Опорная пластина	Altlık Yayı Shim Spring Втулка рычага	Baskı Parçası Wedge Clamp Прижим	Baskı Vidası Clamp Screw Зажимной винт	Anahtar Allen Key Ключ	
PSBNR/L 1616 H09	●	●	16	16	100	13									
2020 K09	○	○	20	20	125	17	SNM. 0903..	APL-01	ALV-02-M6x17	AASN-2-0002	AAY-01	-	-	AAL-02-2.5	
2020 K12	●	●	20	20	125	17									
2525 M12C	●	●	25	25	150	22	SNM. 1204..	APL-02	ALV-03-M8x19	AASN-3-0004	AAY-02	ACK-05	4015-M4x11	AAL-03-3	
3232 P12C	●	●	32	32	170	27									
2525 M15	●	●	25	25	150	22	SNM. 1506..	APL-04	ALV-04-M8x22	AASN-3-0023	AAY-03	-	-		
3232 P15C	●	●	32	32	170	27									
3232 P19C	●	●	32	32	170	27	SNM. 1906..	APL-05	ALV-05-M10x27	AASN-3-0005	AAY-04	ACK-09	AAV-05-M6x15	AAL-05-4	
4040 S19C	●	●	40	40	250	35									
4040 S25C	●	●	40	40	250	35	SNM. 2509..	APL-06	ALV-06-M12x36	AASN-3-0020	AAY-05	ACK-04	AKV-16-M6x16	AAL-07-5	
5050 S25C	●	○	50	50	250	43									

R: Sağ / Right / Правый L: Sol / Left / Левый
● Stokta / In Stock / В наличии ○ Stokta Yok / Non Stock Item / Нет в наличии

Sipariş Örneği/Ordering Example/Образец заказа
1 ad./pcs./шт. PDNNN 1616 H11

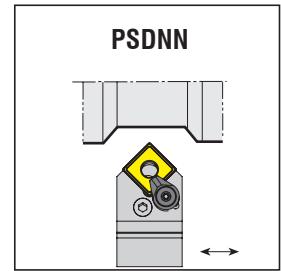
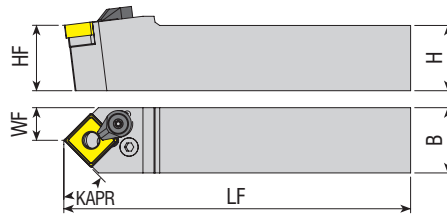

Takım Kodu Ordering Code Код для заказа	Stok Stock Наличие	Takım Ölçüleri (mm) Dimension (mm) Размеры (мм)				Kesici Uç Insert Пластина	Yedek Parçaları / Spare Parts / Запасные части						
		HF=H	B	LF	WF		Levyeye Lever Рычаг	Levyeye Vidası Lever Screw Винт рычага	Altılık Shim Опорная пластина	Altılık Yay Shim Spring Втулка рычага	Baskı Parçası Wedge Clamp Прижим	Baskı Vidası Clamp Screw Зажимной винт	Anahtar Allen Key Ключ
PSDNN 1616 H09	●	16	16	100	8	SNM. 0903..	APL-01	ALV-02-M6x17	AASN-2-0002	AAAY-01	-	-	AAL-02-2.5
2020 K12C	●	20	20	125	10	SNM. 1204..	APL-02	ALV-03-M8x19	AASN-3-0004	AAAY-02	ACK-05	4015-M4x11	AAL-03-3
2525 M12C	●	25	25	150	12.5								
3232 P12C	●	32	32	170	16								
2020 K15	●	20	20	125	10	SNM. 1506..	APL-04	ALV-04-M8x22	AASN-3-0023	AAAY-03	-	-	AAL-05-4
2525 M15C	●	25	25	150	12.5								
3232 P19C	●	32	32	170	16								
4040 S19C	○	40	40	250	20	SNM. 1906..	APL-05	ALV-05-M10x27	AASN-3-0005	AAAY-04	ACK-09	AAV-05-M6x15	AAL-05-4
5050 S19C	○	50	50	250	25	SNM. 2509..	APL-06	ALV-06-M12x36	AASN-3-0020	AAAY-05	ACK-04	AKV-16-M6x16	AAL-07-5
4040 S25C	●	40	40	250	20								
5050 S25C	○	50	50	250	25								

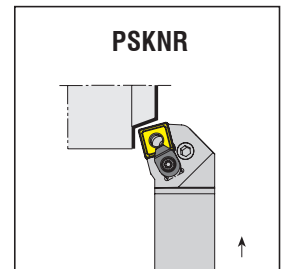
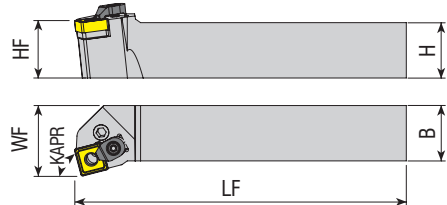

Takım Kodu Ordering Code Код для заказа	Stok Stock Наличие		Takım Ölçüleri (mm) Dimension (mm) Размеры (мм)				Kesici Uç Insert Пластина	Yedek Parçaları / Spare Parts / Запасные части						
	R	L	HF=H	B	LF	WF		Levyeye Lever Рычаг	Levyeye Vidası Lever Screw Винт рычага	Altılık Shim Опорная пластина	Altılık Yay Shim Spring Втулка рычага	Baskı Parçası Wedge Clamp Прижим	Baskı Vidası Clamp Screw Зажимной винт	Anahtar Allen Key Ключ
PSKNR/L 2020 K09	●	○	20	20	125	25	SNM. 0903..	APL-01	ALV-02-M6x17	AASN-2-0002	AAAY-01	-	-	AAL-02-2.5
2020 K12C	●	●	20	20	125	25	SNM. 1204..	APL-02	ALV-03-M8x19	AASN-3-0004	AAAY-02	ACK-05	4015-M4x11	AAL-03-3
2525 M12C	●	●	25	25	150	32								
3232 P12C	●	●	32	32	170	40								
2525 M15C	●	●	25	25	150	32	SNM. 1506..	APL-04	ALV-04-M8x22	AASN-3-0023	AAAY-03	-	-	AAL-05-4
3232 P15C	●	●	32	32	170	40								
3232 P19C	●	●	32	32	170	40								
4040 S19C	●	●	40	40	250	50	SNM. 1906..	APL-05	ALV-05-M10x27	AASN-3-0005	AAAY-04	ACK-09	AAV-05-M6x15	AAL-05-4
4040 S25C	●	●	40	40	250	50	SNM. 2509..	APL-06	ALV-06-M12x36	AASN-3-0020	AAAY-05	ACK-04	AKV-16-M6x16	AAL-07-5
5050 S25C	●	○	50	50	250	60								

R: Sağ / Right / Правый L: Sol / Left / Левый
● Stokta / In Stock / В наличии ○ Stokta Yok / Non Stock Item / Нет в наличии

Sipariş Örneği/Ordering Example/Образец заказа
1 ad./pcs./шт. PSDNN 1616 H09

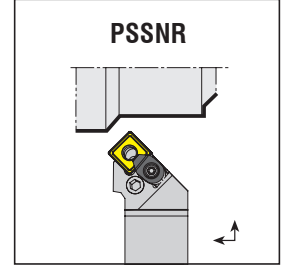
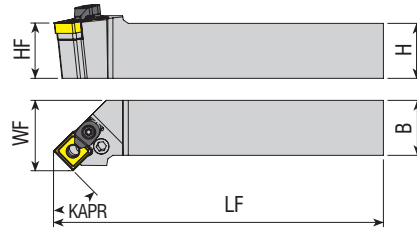

Takım Kodu Ordering Code Код для заказа	Stok Stock Наличие		Takım Ölçüleri (mm) Dimension (mm) Размеры (мм)				Kesici Uç Insert Пластина	Yedek Parçaları / Spare Parts / Запасные части						
	R	L	HF=H	B	LF	WF		Levyeye Lever Рычаг	Levyeye Vidası Lever Screw Винт рычага	Altılık Shim Опорная пластина	Altılık Yayı Shim Spring Втулка рычага	Baskı Parçası Wedge Clamp Прижим	Baskı Vidası Clamp Screw Зажимной винт	Anahtar Allen Key Ключ
PSSNR/L 1616 H09	●	●	16	16	100	20	SNM. 0903..	APL-01	ALV-02-M6x17	AASN-2-0002	AAV-01	-	-	AAL-02-2.5
2020 K09	●	○	20	20	125	25								
2020 K12C	●	●	20	20	125	25	SNM. 1204..	APL-02	ALV-03-M8x19	AASN-3-0004	AAV-02	ACK-05	4015-M4x11	AAL-03-3
2525 M12C	●	●	25	25	150	32								
3232 P12C	●	●	32	32	170	40	SNM. 1506..	APL-04	ALV-04-M8x22	AASN-3-0023	AAV-03			
3232 P15C	●	○	32	32	170	40								
3232 P19C	●	●	32	32	170	40	SNM. 1906..	APL-05	ALV-05-M10x27	AASN-3-0005	AAV-04	ACK-09	AAV-05-M6x15	AAL-05-4
4040 S19C	●	●	40	40	250	50								
4040 S25C	●	●	40	40	250	50	SNM. 2509..	APL-06	ALV-06-M12x36	AASN-3-0020	AAV-05	ACK-04	AKV-16-M6x16	AAL-07-5

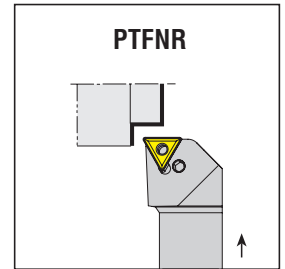
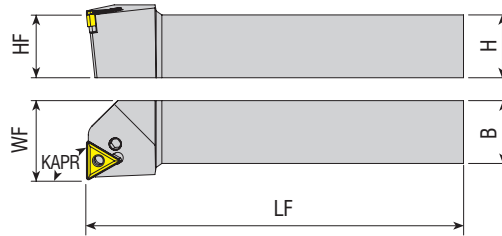

Takım Kodu Ordering Code Код для заказа	Stok Stock Наличие		Takım Ölçüleri (mm) Dimension (mm) Размеры (мм)				Kesici Uç Insert Пластина	Yedek Parçaları / Spare Parts / Запасные части						
	R	L	HF=H	B	LF	WF		Levyeye Lever Рычаг	Levyeye Vidası Lever Screw Винт рычага	Altılık Shim Опорная пластина	Altılık Yayı Shim Spring Втулка рычага	Baskı Parçası Wedge Clamp Прижим	Baskı Vidası Clamp Screw Зажимной винт	Anahtar Allen Key Ключ
PTFNR/L 1616 H16	●	●	16	16	100	20	TNM. 1604..	APL-01	ALV-02-M6x17	AATN-3-0025	AAV-01	-	-	AAL-02-2.5
2020 K16	●	●	20	20	125	25								
2525 M16	●	●	25	25	150	32								
3232 P16	●	●	32	32	170	40	TNM. 2204..	APL-02	ALV-03-M8x19	AATN-3-0015	AAV-02	ACK-05	4015-M4x11	AAL-03-3
2525 M22C	●	●	25	25	150	32								
3232 P22C	●	●	32	32	170	40	TNM. 2706..	APL-05	ALV-05-M10x27	07042701	AAV-04	ACK-09	AAV-05-M6x15	AAL-05-4
4040 S27C	○	○	40	40	250	50								

R: Sağ / Right / Правый L: Sol / Left / Левый

● Stokta / In Stock / В наличии ○ Stokta Yok / Non Stock Item / Нет в наличии

Sipariş Örneği/Ordering Example/Образец заказа

1 ad./pcs./шт. PSSNR 1616 H09

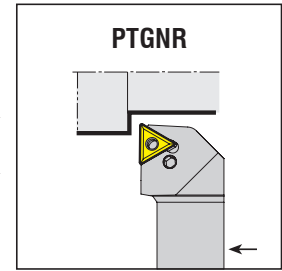
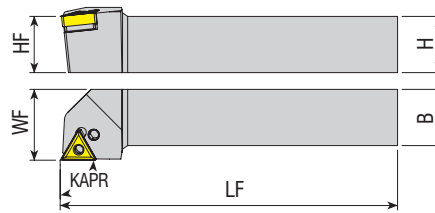

Takım Kodu Ordering Code Код для заказа	Stok Stock Наличие		Takım Ölçüleri (mm) Dimension (mm) Размеры (мм)				Kesici Uç Insert Пластина	Yedek Parçaları / Spare Parts / Запасные части						
	R	L	HF=H	B	LF	WF		Levyeye Lever Рычаг	Levyeye Vidası Lever Screw Винт рычага	Altılık Shim Опорная пластина	Altılık Yay Shim Spring Втулка рычага	Baskı Parçası Wedge Clamp Прижим	Baskı Vidası Clamp Screw Зажимной винт	Anahtar Allen Key Ключ
	○	○												
PTGNR/L 1010 E11	○	○	10	10	70	12	TNM. 1103..	APL-11	ALV-10-M5X10	-	-	-	-	AAL-13-2.5
1212 F11	○	○	12	12	80	16								
1616 H11	○	○	16	16	100	20								
1616 H16	●	●	16	16	100	20	TNM. 1604..	APL-01	ALV-02-M6x17	AATN-3-0025	AAY-01	-	-	AAL-02-2.5
2020 K16	●	●	20	20	125	25								
2525 M16	●	●	25	25	150	32								
3232 P16	○	○	32	32	170	40	TNM. 2204..	APL-02	ALV-03-M8x19	AATN-3-0015	AAY-02	ACK-05	4015-M4x11	AAL-03-3
2525 M22C	●	●	25	25	150	32								
3232 P22C	●	●	32	32	170	40								
4040 S27C	○	○	40	40	250	50	TNM. 2706..	APL-05	ALV-05-M10x27	07042701	AAY-04	ACK-09	AAV-05-M6x15	AAL-05-4

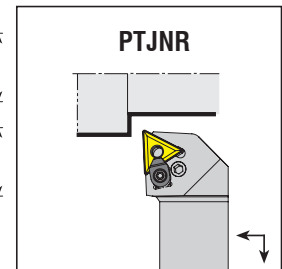
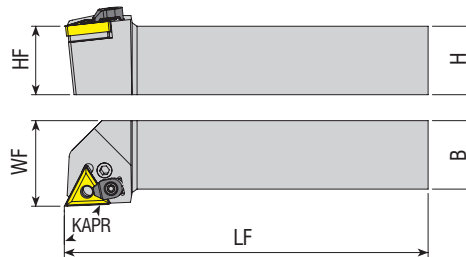

Takım Kodu Ordering Code Код для заказа	Stok Stock Наличие		Takım Ölçüleri (mm) Dimension (mm) Размеры (мм)				Kesici Uç Insert Пластина	Yedek Parçaları / Spare Parts / Запасные части						
	R	L	HF=H	B	LF	WF		Levyeye Lever Рычаг	Levyeye Vidası Lever Screw Винт рычага	Altılık Shim Опорная пластина	Altılık Yay Shim Spring Втулка рычага	Baskı Parçası Wedge Clamp Прижим	Baskı Vidası Clamp Screw Зажимной винт	Anahtar Allen Key Ключ
	○	○												
PTJNR/L 1010 E11	○	○	10	10	70	12	TNM. 1103..	APL-11	ALV-10-M5X10	-	-	-	-	AAL-13-2.5
1212 F11	○	○	12	12	80	16								
1616 H11	○	○	16	16	100	20								
1616 H16	●	●	16	16	100	20	TNM. 1604..	APL-01	ALV-02-M6x17	AATN-3-0025	AAY-01	-	-	AAL-02-2.5
2020 K16	●	●	20	20	125	25								
2525 M16	●	●	25	25	150	32								
3232 P16	●	●	32	32	170	40	TNM. 2204..	APL-02	ALV-03-M8x19	AATN-3-0015	AAY-02	ACK-05	4015-M4x11	AAL-03-3
2525 M22C	●	●	25	25	150	32								
3232 P22C	●	●	32	32	170	40								
4040 S27C	○	○	40	40	250	50	TNM. 2706..	APL-05	ALV-05-M10x27	07042701	AAY-04	ACK-09	AAV-05-M6x15	AAL-05-4

R: Sağ / Right / Правый L: Sol / Left / Левый

● Stokta / In Stock / В наличии ○ Stokta Yok / Non Stock Item / Нет в наличии

Sipariş Örneği/Ordering Example/Образец заказа

1 ad./pcs./шт. PTGNR 1010 E11

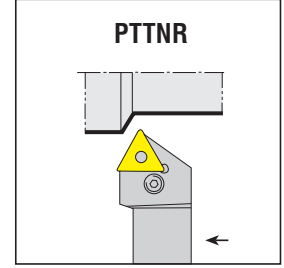
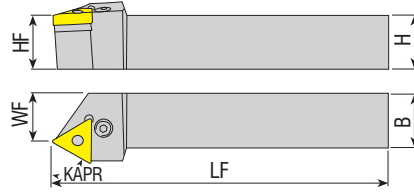
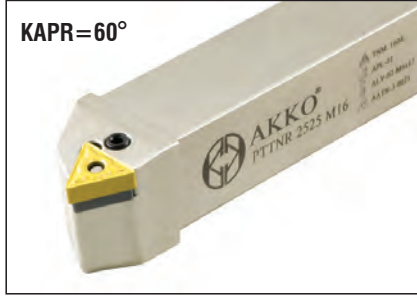

Takım Kodu Ordering Code Код для заказа	Stok Stock Наличие		Takım Ölçüleri (mm) Dimension (mm) Размеры (мм)				Kesici Uç Insert Пластина	Yedek Parçaları / Spare Parts / Запасные части						
	R	L	HF=H	B	LF	WF		Levyeye Lever Рычаг	Levyeye Vidası Lever Screw Винт рычага	Altılık Shim Опорная пластина	Altılık Yayı Shim Spring Втулка рычага	Baskı Parçası Wedge Clamp Прижим	Baskı Vidası Clamp Screw Зажимной винт	Anahtar Allen Key Ключ
PTTNR/L 1616 H16	●	●	16	16	100	13	TNM. 1604..	APL-01	ALV-02-M6x17	AATN-3-0025	AAV-01	-	-	AAL-02-2.5
2020 K16	●	●	20	20	125	17								
2525 M16	●	●	25	25	150	21.5								
3232 P16	●	●	32	32	170	31								
2525 M22C	●	●	25	25	150	20.5	TNM. 2204..	APL-02	ALV-03-M8x19	AATN-3-0015	AAV-02	ACK-05	4015-M4x11	AAL-03-3
3232 P22C	●	●	32	32	170	29								

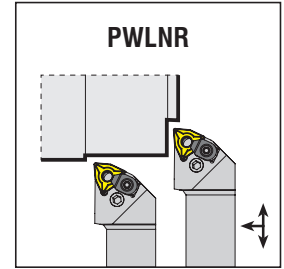
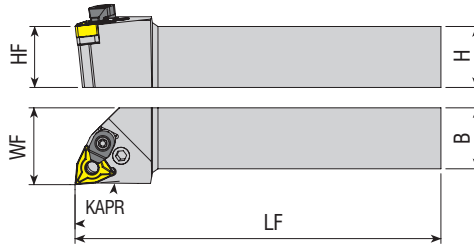

Takım Kodu Ordering Code Код для заказа	Stok Stock Наличие		Takım Ölçüleri (mm) Dimension (mm) Размеры (мм)				Kesici Uç Insert Пластина	Yedek Parçaları / Spare Parts / Запасные части						
	R	L	HF=H	B	LF	WF		Levyeye Lever Рычаг	Levyeye Vidası Lever Screw Винт рычага	Altılık Shim Опорная пластина	Altılık Yayı Shim Spring Втулка рычага	Baskı Parçası Wedge Clamp Прижим	Baskı Vidası Clamp Screw Зажимной винт	Anahtar Allen Key Ключ
PWLNR/L 1616 H06	●	●	16	16	100	20	WNM. 0604..	APL-01	ALV-02-M6x17	AAWN-SW317	AAV-01	-	-	AAL-02-2.5
2020 K06	●	●	20	20	125	25								
2525 M06	●	●	25	25	150	32								
3232 P06	○	○	32	32	170	40								
1616 H08	●	●	16	16	100	20	WNM. 0804..	APL-02	ALV-03-M8x19	AAWN-3-0001	AAV-02	ACK-05	4015-M4x11	AAL-03-3
2020 K08C	●	●	20	20	125	25								
2525 M08C	●	●	25	25	150	32								
3232 P08C	●	●	32	32	170	40								

R: Sağ / Right / Правый L: Sol / Left / Левый
● Stokta / In Stock / В наличии ○ Stokta Yok / Non Stock Item / Нет в наличии

Sipariş Örneği/Ordering Example/Образец заказа
1 ad./pcs./шт. PTTNR 1616 H16

P-SİSTEM

P-SİSTEM İÇTEN SOĞUTMA KANALLI DIŞ TORNA KATERLERİ
P-SYSTEM EXTERNAL TURNING TOOLHOLDERS WITH COOLANT HOLE
P-ТИП ДЕРЖАВКИ ДЛЯ НАРУЖНОГО ТОЧЕНИЯ С ПОДВОДОМ СОЖ

konusulan
the spoken kalite...
quality...



DETAYLI BİLGİ İÇİN BARKODU OKUTUNUZ

SCAN ME FOR MORE DETAILS

ПРОСКАНИРУЙТЕ ДЛЯ ПОЛУЧЕНИЯ БОЛЕЕ ПОДРОБНОЙ ИНФОРМАЦИИ

P-SİSTEM İÇTEN SOĞUTMA KANALLI DIŞ TORNA KATERLERİ
P-SYSTEM EXTERNAL TURNING TOOLHOLDERS WITH COOLANT HOLE
P-ТИП ДЕРЖАВКИ ДЛЯ НАРУЖНОГО ТОЧЕНИЕ С ПОДВОДОМ СОЖ

new

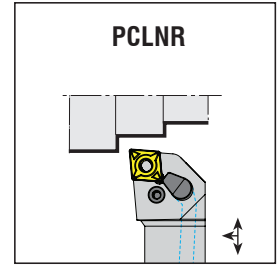
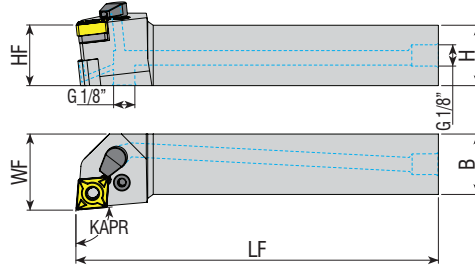

Takım Kodu
Ordering Code
Код для заказа

Stok Stock Наличие	Takım Ölçüleri (mm) Dimension (mm) Размеры (мм)						Kesici Uç Insert Пластина	Levyeye Lever Рычаг	Levyeye Vidası Lever Screw Винт рычага	Altılık Shim Опорная пластина	Altılık Yayı Shim Spring Втулка рычага	Oring Ring Кольцо	Sızdırmaz Vida Threaded Pin Резьбовой Винт	Nozul Nozzle Прижим СОЖ	Anahtar Allen Key Ключ
	R	L	HF=H	B	LF	WF									
	●	●	20	20	125	25									
PCLNR/L 2020 K12-H	●	●	20	20	125										
2525 M12-H	●	●	25	25	150										
3232 P12-H	●	○	32	32	170	40									

new

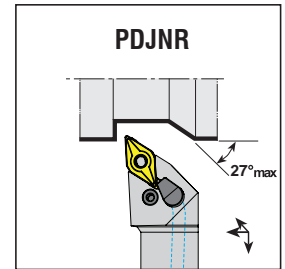
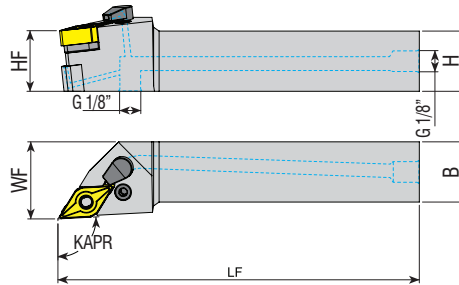

Takım Kodu
Ordering Code
Код для заказа

Stok Stock Наличие	Takım Ölçüleri (mm) Dimension (mm) Размеры (мм)						Kesici Uç Insert Пластина	Levyeye Lever Рычаг	Levyeye Vidası Lever Screw Винт рычага	Altılık Shim Опорная пластина	Altılık Yayı Shim Spring Втулка рычага	Oring Ring Кольцо	Sızdırmaz Vida Threaded Pin Резьбовой Винт	Nozul Nozzle Прижим СОЖ	Anahtar Allen Key Ключ
	R	L	HF=H	B	LF	WF									
	●	●	20	20	125	25									
PDJNR/L 2020 K15-H	●	●	20	20	125										
2525 M15-H	●	●	25	25	150										
3232 P15-H	●	○	32	32	170	40									

R: Sağ / Right / Правый L: Sol / Left / Левый

● Stokta / In Stock / В наличии ○ Stokta Yok / Non Stock Item / Нет в наличии

Sipariş Örneği/Ordering Example/Образец заказа

1 ad./pcs./шт. PCLNR 2020 K12-H

AKKO

www.akko.com.tr

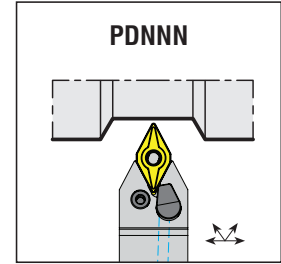
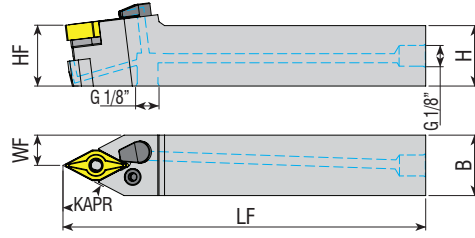
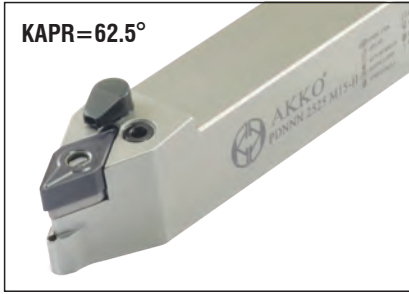

Takım Kodu Ordering Code Код для заказа	Stok Stock Наличие	Takım Ölçüleri (mm) Dimension (mm) Размеры (мм)				Kesici Uç Insert Пластина	Yedek Parçaları / Spare Parts / Запасные части									
		HF=H	B	LF	WF		Levyeye Lever Рычаг	Levyeye Vidası Lever Screw Винт рычага	Altılık Shim Отверная пластина	Altılık Yayı Shim Spring Втулка рычага	Oring Ring Кольцо	Sızdırmaz Vida Threaded Pin Резьбовой Винт	Nozul Nozzle Прижим СОЖ	Anahtar Allen Key Ключ		
PDNNN 2525 M15-H	●	25	25	150	32											
						DNM. 1506..	APL-03	ALV-03-M8x19	AADN-3-0001	AAV-02	AXR-01 AOR-01	2705-G1/8x5.5	AN-01	AAL-03-3		

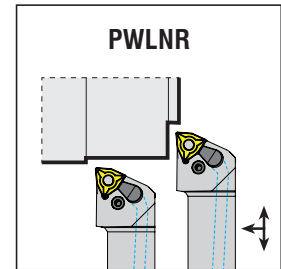
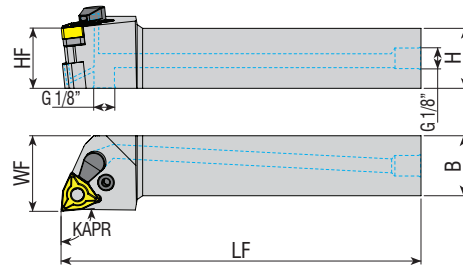

Takım Kodu Ordering Code Код для заказа	Stok Stock Наличие		Takım Ölçüleri (mm) Dimension (mm) Размеры (мм)				Kesici Uç Insert Пластина	Yedek Parçaları / Spare Parts / Запасные части									
	R	L	HF=H	B	LF	WF		Levyeye Lever Рычаг	Levyeye Vidası Lever Screw Винт рычага	Altılık Shim Отверная пластина	Altılık Yayı Shim Spring Втулка рычага	Oring Ring Кольцо	Sızdırmaz Vida Threaded Pin Резьбовой Винт	Nozul Nozzle Прижим СОЖ	Anahtar Allen Key Ключ		
PWLNR/L 2020 K08-H	●	●	20	20	125	25											
2525 M08-H	●	●	25	25	150	32	WNM. 0804..	APL-02	ALV-03-M8x19	AAWN-3-0001	AAV-02	AXR-01 AOR-01	2705-G1/8x5.5	AN-01	AAL-03-3		

R: Sağ / Right / Правый L: Sol / Left / Левый
● Stokta / In Stock / В наличии ○ Stokta Yok / Non Stock Item / Нет в наличии

Sipariş Örneği/Ordering Example/Образец заказа
1 ad./pcs./шт. PDNNN 2525 M15-H

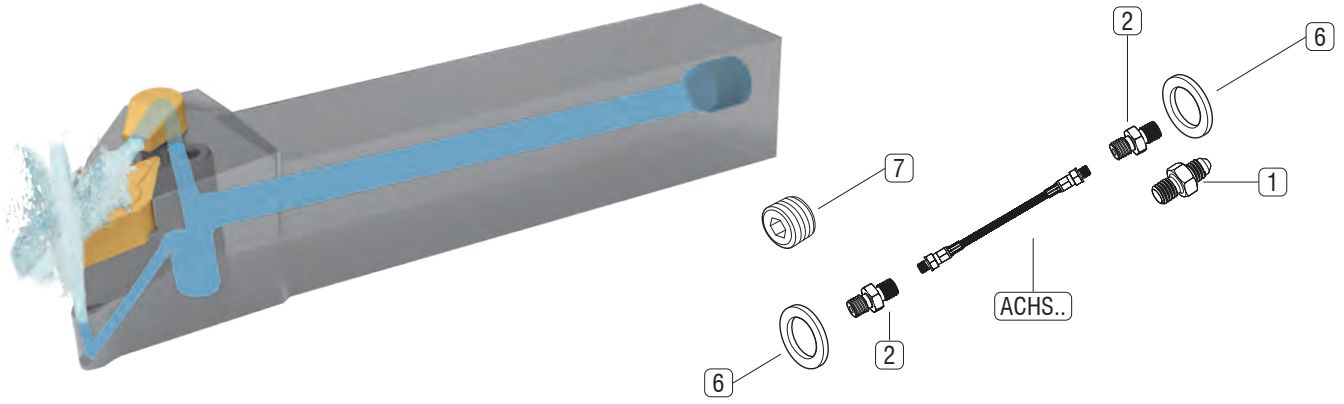

Not: İçten soğutmalı tüm torna katerlerinde kullanılacak 3 tip soğutma hortum setleri tasarlanmıştır. Takımların kullanılmasından önce, kullanılmayan bağlantıların set içindeki vida ile kapatılarak sızdırmazlığın sağlanmasına dikkat edilmelidir. Torna katerlerine yönelik soğutma hortum setleri, ACHS... 10 bar ile maksimum 275 bar basınç aralığında kullanılabilir.

Note: 3 types of cooling hose sets are designed that can be used in all internally cooled lathes. Before using the tools, care should be taken to ensure that the unused connections are closed with the screw in the set and that sealing is ensured. Cooling hose sets for lathe tools can be used in the pressure range of ACHS ... 10 bar to max 275 bar.

Примечание: Предлагается 3 типа комплектов трубок для подвода СОЖ. Они могут использоваться на всех токарных станках оснащенных системой подвода СОЖ. Перед началом работ необходимо закрыть неиспользуемые соединения винтом из набора и обеспечить герметичность системы подвода СОЖ. Комплекты охлаждающих трубок, для токарных инструментов, могут использоваться в диапазоне давлений АСНС от 10 бар до 275 бар.

Set İçindeki Parçalar Parts In The Set Запчасти в Наборе				Uzunluk / Length Code / Длина		
				Set Kodu: Set Code: Код Набора: ACHS-1-250	Set Kodu: Set Code: Код Набора: ACHS-2-250	Set Kodu: Set Code: Код Набора: ACHS-3-250
	Resim Picture Рисунок	Takım Kodu Set Code Код Набора	Ürün Açıklaması Product Description Описание товара			
1		AMP-01	M10 Bağlantı Elemanı M10 Fastener Застежка M10	1x	-	-
2		AMP-02	G 1/8" Çift Bağlantı Elemanı G 1/8" Double Fastener G 1/8" двойная застежка	2x	1x	-
3		AMP-03	G 1/8" Açılı Bağlantısı G 1/8" Angle Connection G 1/8" угловое соединение	-	1x	2x
4		AMP-04	M10" Açılı Bağlantısı M10" Angle Connection M10" угловое соединение	-	1x	1x
5		AMP-05	G1/4"-G1/8" Kılcalma Parçası G1 / 4"-G1/8" Capillary Piece G1 / 4"-G1/8" Капиллярная часть	-	1x	1x
6		AG-01	Bakır Conta Copper Gasket Медная прокладка	2x	3x	4x
7		2705-G1/8-5.5	G1/8" Sızdırmaz Civata G1/8" Sealing Bolt G1/8" Уплотнительный болт	1x	1x	1x
8		AH-1-250	Hortum Hose Трубка	1x	-	-
9		AH-2-250	Hortum Hose Трубка	-	1x	-
10		AH-3-250	Hortum Hose Трубка	-	-	1x

C-SİSTEM

C-SİSTEM DIŞ TORNA KATERLERİ
C-SYSTEM EXTERNAL TURNING TOOLHOLDERS
C-ТИП ДЕРЖАВКИ ДЛЯ НАРУЖНОГО ТОЧЕНИЯ

*konusulan
the spoken kalite...
quality...*



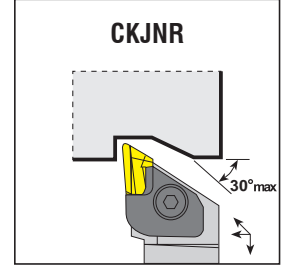
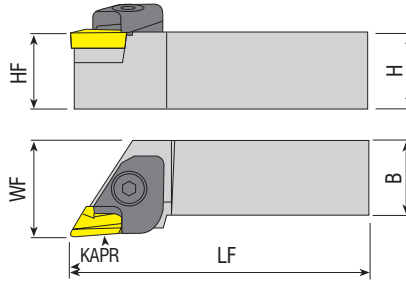

Takım Kodu
Ordering Code
Код для заказа

Stok
Stock
Наличие

Takım Ölçüleri (mm)
Dimension (mm)
Размеры (мм)

Kesici Uç
Insert
Пластина

Baskı Pabuçu
Wedge Clamp
Прижим

Pabuç Vidası
Clamp Screw
Зажимной винт

Altlık
Shim
Опорная пластина

Altlık Vidası
Shim Screw
Винт опорной пластины

Yay
Spring
Пружина

Pul
Stamp
Шайба

Anahtar
Allen Key
Ключ

R L

HF=H

B

LF

WF



CKJNR/L 2020 K16

2525 M16

3232 P16

4040 S16

● ●

● ●

20

20

125

27.5

● ●

● ●

25

25

150

31.5

● ●

● ●

32

32

170

40

● ●

● ●

40

40

250

50

KNUX 1604..

ACK-01-R
ACK-02-L

AKV-06-M16x20

AKS-16-R
AKS-16-L

AAV-01-M3x10

AKY-02

ABPL-01

AAL-05-4

Yedek Parçaları / Spare Parts / Запасные части

R: Sağ / Right / Правый L: Sol / Left / Левый

● Stokta / In Stock / В наличии ○ Stokta Yok / Non Stock Item / Нет в наличии

Sipariş Örneği/Ordering Example/Образец заказа

1 ad./pcs./шт. CKJNR 2020 K16



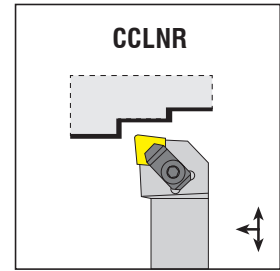
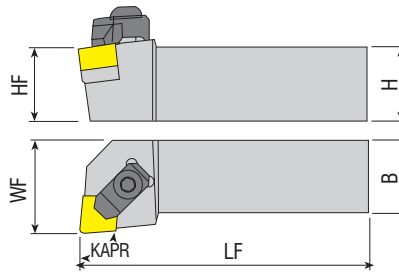
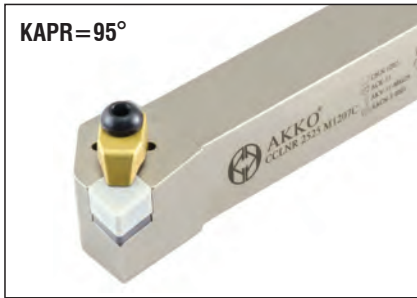

Takım Kodu
Ordering Code
Код для заказа

Stok Stock Наличие	Takım Ölçüleri (mm) Dimension (mm) Размеры (мм)						Kesici Uç Insert Пластина	Yedek Parçaları / Spare Parts / Запасные части						
	R	L	HF=H	B	LF	WF		Baskı Pabucu Wedge Clamp Прижим	Pabuç Vidası Clamp Screw Зажимной винт	Altlık Shim Опорная пластина	Altlık Vidası Shim Screw Винт опорной пластины	Sekman Ring Кольцо	Anahtar Allen Key Ключ	
	●	●	25	25	150	32								
CCLNR/L 2525 M1207C	●	●	25	25	150	32	CN.N 1207..							
3232 P1207C	●	●	32	32	170	40								
2525 M1607C	●	●	25	25	150	32								CN.N 1607..

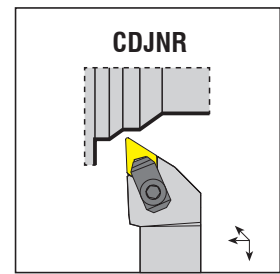
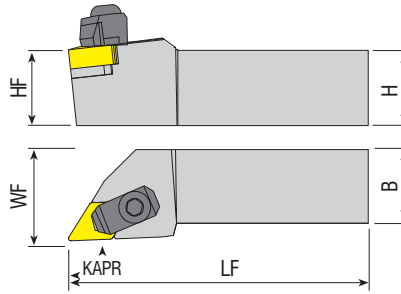

Takım Kodu
Ordering Code
Код для заказа

Stok Stock Наличие	Takım Ölçüleri (mm) Dimension (mm) Размеры (мм)						Kesici Uç Insert Пластина	Yedek Parçaları / Spare Parts / Запасные части						
	R	L	HF=H	B	LF	WF		Baskı Pabucu Wedge Clamp Прижим	Pabuç Vidası Clamp Screw Зажимной винт	Altlık Shim Опорная пластина	Altlık Vidası Shim Screw Винт опорной пластины	Sekman Ring Кольцо	Anahtar Allen Key Ключ	
	●	●	25	25	150	32								
CDJNR/L 2525 M1107C	●	●	25	25	150	32	DN.N 1107..							
2525 M1507C	●	●	25	25	150	32								
3232 P1507C	●	●	32	32	170	40								DN.N 1507..

R: Sağ / Right / Правый L: Sol / Left / Левый

● Stokta / In Stock / В наличии ○ Stokta Yok / Non Stock Item / Нет в наличии

Sipariş Örneği/Ordering Example/Образец заказа

1 ad./pcs./шт. CCLNR 2525 M1207C

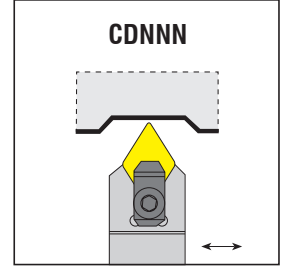
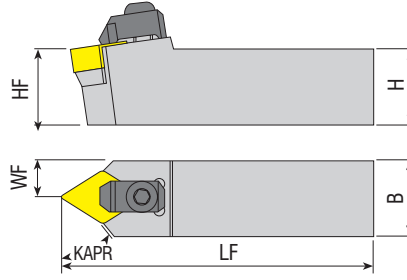

Takım Kodu Ordering Code Код для заказа	Stok Stock Наличие	Takım Ölçüleri (mm) Dimension (mm) Размеры (мм)				Kesici Uç Insert Пластина	Yedek Parçaları / Spare Parts / Запасные части					
		HF=H	B	LF	WF		Baskı Pabucu Wedge Clamp Прижим	Pabuç Vidası Clamp Screw Зажимной винт	Altlık Shim Опорная пластина	Altlık Vidası Shim Screw Винт опорной пластины	Sekman Ring Кольцо	Anahtar Allen Key Ключ
CDNNN 2525 M1107C	●	25	25	150	12.5	DN.N 1107..	ACK-22	AKV-11-M8x29	AADN-2-0001	AAV-04-M5x12	ACS-01	AAL-05-4

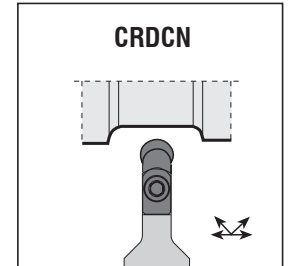
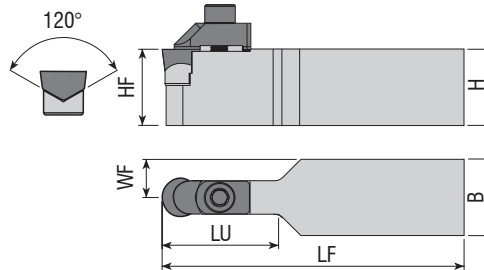

Takım Kodu Ordering Code Код для заказа	Stok Stock Наличие	Takım Ölçüleri (mm) Dimension (mm) Размеры (мм)					Kesici Uç Insert Пластина	Yedek Parçaları / Spare Parts / Запасные части				
		HF=H	B	LF	LU	WF		Baskı Pabucu Wedge Clamp Прижим	Pabuç Vidası Clamp Screw Зажимной винт	Altlık Shim Опорная пластина	Altlık Vidası Shim Screw Винт опорной пластины	Anahtar Allen Key Ключ
CRDCN 2525 M06CV	●	25	25	150	19	12.5	RCGX 0606..	ACK-27	2525-M3X14	AARC-3-0001	3007-M2.2X5	AAL-02-2.5
3225 P06CV	●	32	25	170	19	12.5						
4040 S06CV	●	40	40	250	19	20						
2525 M09CV	●	25	25	150	29	12.5	RCGX 0907..	ACK-28	2504-M5X16	AARC-3-0002	3008-M2.5x6	AAL-05-4
3225 P09CV	●	32	25	170	29	12.5						
4040 S09CV	●	40	40	250	29	20						
2525 M12CV	●	25	25	150	38	12.5	RCGX 1207..	ACK-29	2505-M6X20	AARC-3-0003	3008-M2.5x6	AAL-07-5
3225 P12CV	●	32	25	170	38	12.5						
4040 S12CV	●	40	40	250	38	20						

R: Sağ / Right / Правый L: Sol / Left / Левый
● Stokta / In Stock / В наличии ○ Stokta Yok / Non Stock Item / Нет в наличии

Sipariş Örneği/Ordering Example/Образец заказа
1 ad./pcs./шт. CDNNN 2525 M1107C

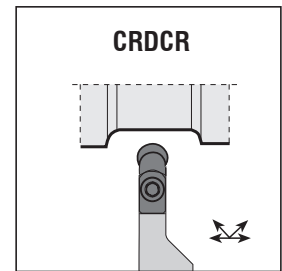
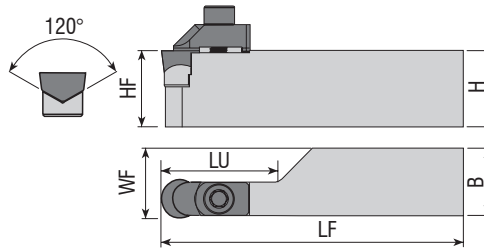

Takım Kodu Ordering Code Код для заказа	Stok Stock Наличие		Takım Ölçüleri (mm) Dimension (mm) Размеры (мм)					Kesici Uç Insert Пластина	Baskı Pabucu Wedge Clamp Прижим	Pabuç Vidası Clamp Screw Зажимной винт	Altlık Shim Опорная пластина	Altlık Vidası Shim Screw Винт опорной пластины	Anahtar Allen Key Ключ
	R	L	HF=H	B	LF	LU	WF						
CRDCR/L 3225 P06CV	●	●	32	25	170	19.4	25.6	RCGX 0606..	ACK-27	2525-M3X14	AARC-3-0001	3007-M2.2X5	AAL-02-2.5
3225 P09CV	●	●	32	25	170	29	25.8	RCGX 0907..	ACK-28	2504-M5X16	AARC-3-0002	3008-M2.5x6	AAL-05-4
3225 P12CV	●	●	32	25	170	38.5	25.9	RCGX 1207..	ACK-29	2505-M6X20	AARC-3-0003	3008-M2.5x6	AAL-07-5

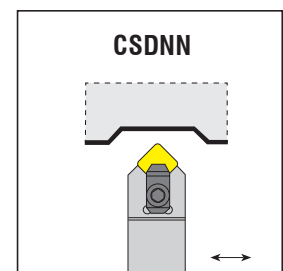
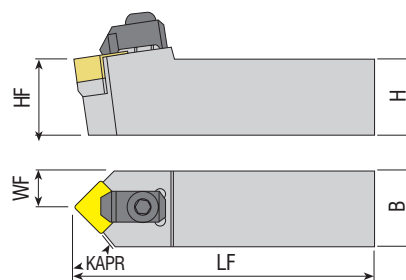

Takım Kodu Ordering Code Код для заказа	Stok Stock Наличие		Takım Ölçüleri (mm) Dimension (mm) Размеры (мм)				Kesici Uç Insert Пластина	Baskı Pabucu Wedge Clamp Прижим	Pabuç Vidası Clamp Screw Зажимной винт	Altlık Shim Опорная пластина	Altlık Vidası Shim Screw Винт опорной пластины	Sekman Ring Кольцо	Anahtar Allen Key Ключ
	HF=H	B	LF	WF									
CSDNN 2525 M1207C	●		25	25	150	12.5	SN.N 1207..	ACK-13	AKV-11-M8x29	AASN-3-0004	AAV-02-M5x12	ACS-01	AAL-05-4
3232 P1207C	●		32	32	170	16							

R: Sağ / Right / Правый L: Sol / Left / Левый

● Stokta / In Stock / В наличии ○ Stokta Yok / Non Stock Item / Нет в наличии

Sipariş Örneği/Ordering Example/Образец заказа

1 ad./pcs./шт. CRDCR 3225 P06CV

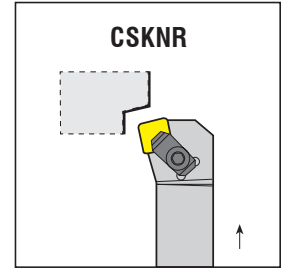
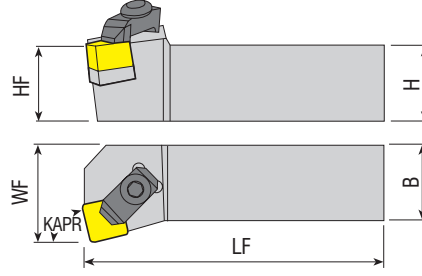
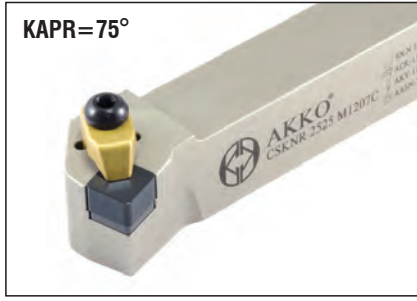

Takım Kodu
Ordering Code
 Код для заказа

Stok Stock Наличие	Takım Ölçüleri (mm) Dimension (mm) Размеры (мм)					Kesici Uç Insert Пластина	Yedek Parçaları / Spare Parts / Запасные части						
	R	L	HF=H	B	LF		WF	Baskı Pabucu Wedge Clamp Прижим	Pabuç Vidası Clamp Screw Зажимной винт	Altık Shim Опорная пластина	Altık Vidası Shim Screw Винт опорной пластины	Sekman Ring Кольцо	Anahtar Allen Key Ключ
CSKNR/L 2525 M1207C	●	●	25	25	150	32	SN.N 1207..	ACK-13	AKV-11-M8x29	AASN-3-0004	AAV-02-M5x12	ACS-01	AAL-05-4
3232 P1207C	●	●	32	32	170	40							

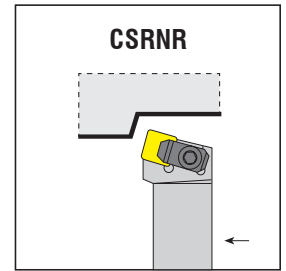
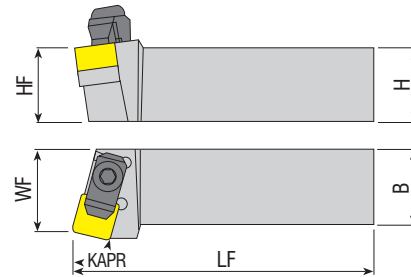

Takım Kodu
Ordering Code
 Код для заказа

Stok Stock Наличие	Takım Ölçüleri (mm) Dimension (mm) Размеры (мм)					Kesici Uç Insert Пластина	Yedek Parçaları / Spare Parts / Запасные части						
	R	L	HF=H	B	LF		WF	Baskı Pabucu Wedge Clamp Прижим	Pabuç Vidası Clamp Screw Зажимной винт	Altık Shim Опорная пластина	Altık Vidası Shim Screw Винт опорной пластины	Sekman Ring Кольцо	Anahtar Allen Key Ключ
CSRNR/L 2525 M1207C	●	●	25	25	150	32	SN.N 1207..	ACK-13	AKV-11-M8x29	AASN-3-0004	AAV-02-M5x12	ACS-01	AAL-05-4
3232 P1207C	●	●	32	32	170	40							

R: Sağ / Right / Правый L: Sol / Left / Левый
 ● Stokta / In Stock / В наличии ○ Stokta Yok / Non Stock Item / Нет в наличии

Sipariş Örneği/Ordering Example/Образец заказа
 1 ad./pcs./шт. CSKNR 2525 M1207C

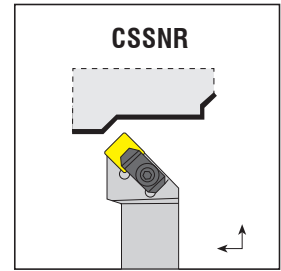
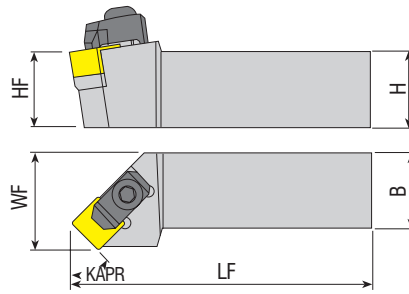

Takım Kodu Ordering Code Код для заказа	Stok Stock Наличие		Takım Ölçüleri (mm) Dimension (mm) Размеры (мм)				Kesici Uç Insert Пластина	Yedek Parçaları / Spare Parts / Запасные части					
	R	L	HF=H	B	LF	WF		Baskı Pabucu Wedge Clamp Прижим	Pabuç Vidası Clamp Screw Зажимной винт	Altlık Shim Опорная пластина	Altlık Vidası Shim Screw Винт опорной пластины	Sekman Ring Кольцо	Anahtar Allen Key Ключ
	●	○											
CSSNR/L 2525 M1207C	●	●	25	25	150	32	SN.N 1207..	ACK-13	AKV-11-M8x29	AASN-3-0004	AAV-02-M5x12	ACS-01	AAL-05-4
3232 P1207C	●	●	32	32	170	40							

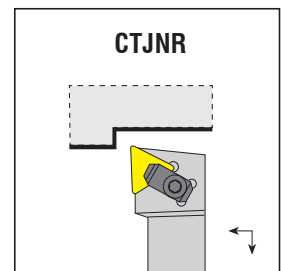
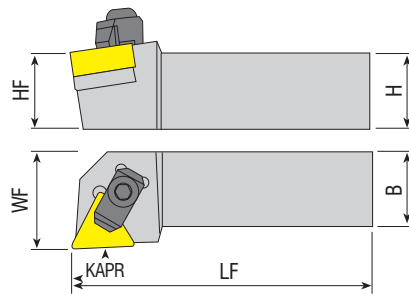

Takım Kodu Ordering Code Код для заказа	Stok Stock Наличие		Takım Ölçüleri (mm) Dimension (mm) Размеры (мм)				Kesici Uç Insert Пластина	Yedek Parçaları / Spare Parts / Запасные части					
	R	L	HF=H	B	LF	WF		Baskı Pabucu Wedge Clamp Прижим	Pabuç Vidası Clamp Screw Зажимной винт	Altlık Shim Опорная пластина	Altlık Vidası Shim Screw Винт опорной пластины	Sekman Ring Кольцо	Anahtar Allen Key Ключ
	●	○											
CTJNR/L 2525 M1607C	●	●	25	25	150	32	TN.N 1607..	ACK-14	AKV-11-M8x29	AATN-2-0002	AAV-03-M5x12	ACS-01	AAL-05-4
3232 P1607C	○	○	32	32	170	40							

R: Sağ / Right / Правый L: Sol / Left / Левый
● Stokta / In Stock / В наличии ○ Stokta Yok / Non Stock Item / Нет в наличии

Sipariş Örneği/Ordering Example/Образец заказа
1 ad./pcs./шт. CSSNR 2525 M1207C



*konusulan
the spoken kalite...
quality...*

S-SİSTEM

S-SİSTEM DIŞ TORNA KATERLERİ
S-SYSTEM EXTERNAL TURNING TOOLHOLDERS
S-ТИП ДЕРЖАВКИ ДЛЯ НАРУЖНОГО ТОЧЕНИЯ



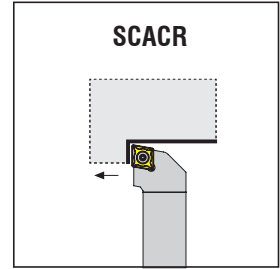
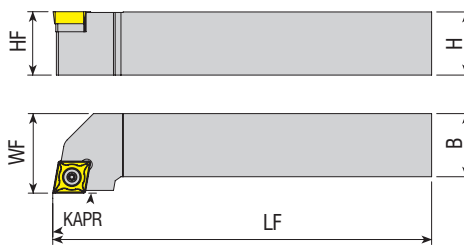
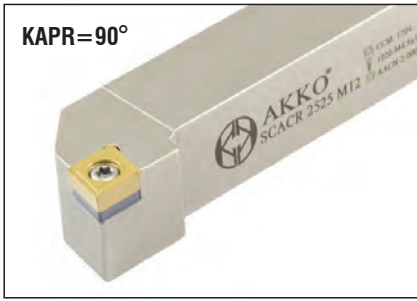

Takım Kodu Ordering Code Код для заказа	Stok Stock Наличие		Takım Ölçüleri (mm) Dimension (mm) Размеры (мм)				Kesici Uç Insert Пластина	Yedek Parçaları / Spare Parts / Запасные части			
	R	L	HF=H	B	LF	WF		Sıkma Vidası Screw Зажимной винт	Altılık Shim Опорная пластина	Altılık Vidası Shim Screw Винт опорной пластины	Tork Anahtar Torx Key Торх Ключ
SCACR/L 0808 E06	●	●	08	08	70	10	CCM. 0602..	4008-M2.5x6	-	-	80-T08
1010 E06	●	●	10	10	70	12					
1212 F09	●	●	12	12	80	16					
1616 H09	●	●	16	16	100	20	CC.T 09T3..	4015-M3.5x14	AACN-2-0001	AAV-06-M3.5x11	80-T15
2020 K09	●	●	20	20	125	25					
2020 K12	●	●	20	20	125	25	CC.T 1204..	1020-M4.5x16	AACN-2-0003	AAV-07-M4.5x13	80-T20
2525 M12	●	●	25	25	150	32					

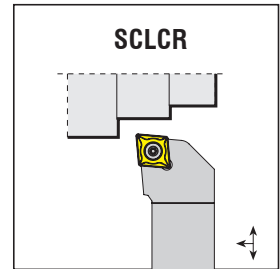
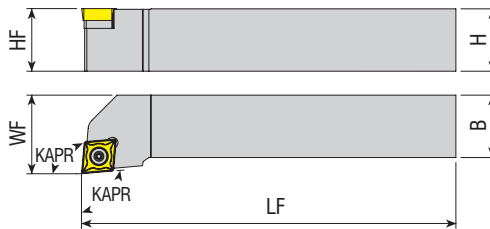
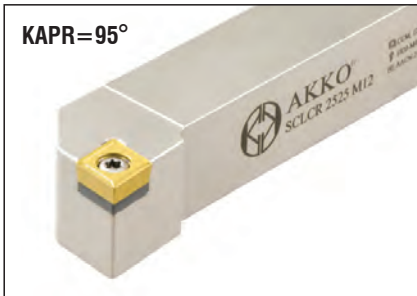

Takım Kodu Ordering Code Код для заказа	Stok Stock Наличие		Takım Ölçüleri (mm) Dimension (mm) Размеры (мм)				Kesici Uç Insert Пластина	Yedek Parçaları / Spare Parts / Запасные части			
	R	L	HF=H	B	LF	WF		Sıkma Vidası Screw Зажимной винт	Altılık Shim Опорная пластина	Altılık Vidası Shim Screw Винт опорной пластины	Tork Anahtar Torx Key Торх Ключ
SCLCR/L 0808 E06	●	●	08	08	70	10	CCM. 0602..	4008-M2.5x6	-	-	80-T08
1010 E06	●	○	10	10	70	12					
1212 F06	●	●	12	12	80	16					
1010 E09	●	●	10	10	70	12	CC.T 09T3..	4015-M3x9 4015-M3.5x11	-	-	80-T15
1212 F09	●	●	12	12	80	16					
1616 H09	●	●	16	16	100	20					
2020 K09	●	●	20	20	125	25	CC.T 1204..	4015-M3.5x14	AACN-2-0001	AAV-06-M3.5x11	80-T15
2525 M09	●	●	25	25	150	32					
1616 H12	●	○	16	16	100	20	CC.T 1204..	1020-M5x11 1020-M4.5x16	-	-	80-T20
2020 K12	●	●	20	20	125	25					
2525 M12	●	●	25	25	150	32					

R: Sağ / Right / Правый L: Sol / Left / Левый
● Stokta / In Stock / В наличии ○ Stokta Yok / Non Stock Item / Нет в наличии

Sipariş Örneği/Ordering Example/Образец заказа
1 ad./pcs./шт. SCACR 0808 E06

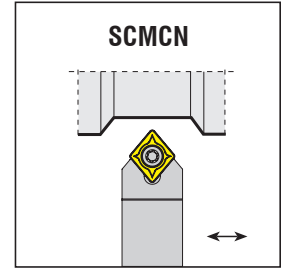
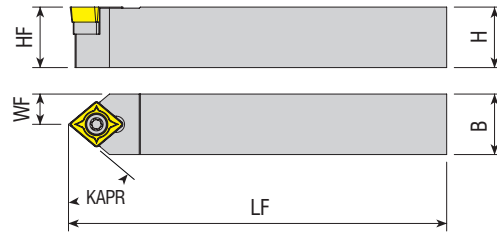
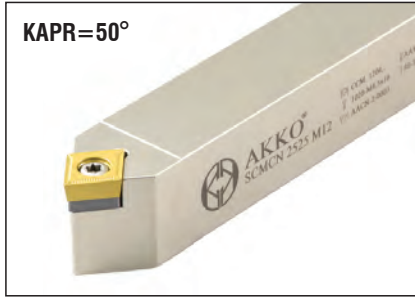

Takım Kodu Ordering Code Код для заказа	Stok Stock Наличие		Takım Ölçüleri (mm) Dimension (mm) Размеры (мм)				Kesici Uç Insert Пластина	Yedek Parçaları / Spare Parts / Запасные части			
	R	L	HF=H	B	LF	WF		Sikma Vidası Screw Зажимной винт	Altlık Shim Опорная пластина	Altlık Vidası Shim Screw Винт опорной пластины	Tork Anahtar Torx Key Торх Ключ
SCMCN 0808 E06	●		08	08	70	04	CCM. 0602..	4008-M2.5x6	-	-	80-T08
1010 E06	●		10	10	70	05					
1212 F06	●		12	12	80	06					
1212 F09	●		12	12	80	06	CC.T 09T3..	4015-M3.5x11 4015-M3.5x14	AACN-2-0001	AAV-06-M3.5x11	80-T15
1616 H09	●		16	16	100	08					
2020 K12	●		20	20	125	10	CC.T 1204..	1020-M4.5x16	AACN-2-0003	AAV-07-M4.5x13	80-T20
2525 M12	●		25	25	150	12.5					

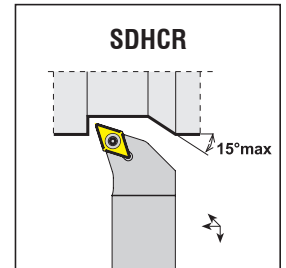
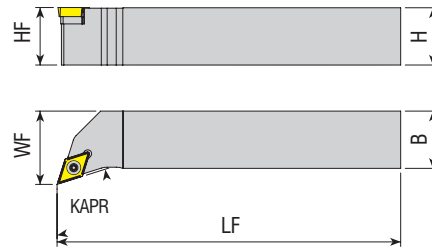

Takım Kodu Ordering Code Код для заказа	Stok Stock Наличие		Takım Ölçüleri (mm) Dimension (mm) Размеры (мм)				Kesici Uç Insert Пластина	Yedek Parçaları / Spare Parts / Запасные части			
	R	L	HF=H	B	LF	WF		Sikma Vidası Screw Зажимной винт	Altlık Shim Опорная пластина	Altlık Vidası Shim Screw Винт опорной пластины	Tork Anahtar Torx Key Торх Ключ
SDHCR/L 0808 E07	●	●	08	08	70	11	DC.T 0702..	4008-M2.5x6	-	-	80-T08
1010 E07	●	●	10	10	70	12					
1212 F07	●	●	12	12	80	16					
1616 H07	●	●	16	16	100	20					
1616 H11	●	●	16	16	100	20	DC.T 11T3..	4015-M3.5x14	AADN-2-0001	AAV-06-M3.5x11	80-T15
2020 K11	●	●	20	20	125	25					
2525 M11	●	●	25	25	150	32					
3232 P11	●	●	32	32	170	40					

R: Sağ / Right / Правый L: Sol / Left / Левый
● Stokta / In Stock / В наличии ○ Stokta Yok / Non Stock Item / Нет в наличии

Sipariş Örneği/Ordering Example/Образец заказа
1 ad./pcs./шт. SCMCN 0808 E06

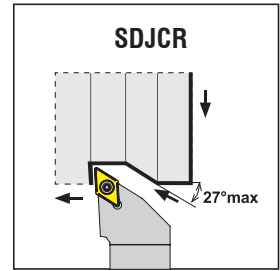
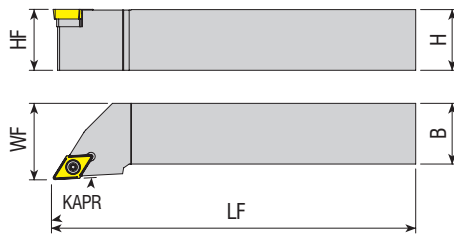
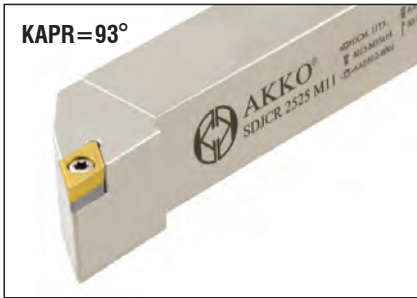

Takım Kodu Ordering Code Код для заказа	Stok Stock Наличие		Takım Ölçüleri (mm) Dimension (mm) Размеры (мм)				Kesici Uç Insert Пластина	Yedek Parçaları / Spare Parts / Запасные части			
	R	L	HF=H	B	LF	WF		Sıkma Vidası Screw Зажимной винт	Altılık Shim Опорная пластина	Altılık Vidası Shim Screw Винт опорной пластины	Tork Anahtar Torx Key Торх Ключ
SDJCR/L 0808 E07	●	●	08	08	70	10	DC.T 0702..				
1010 E07	●	●	10	10	70	12					
1212 F07	●	●	12	12	80	16					
1616 H07	●	●	16	16	100	20					
1616 H11	●	●	16	16	100	20	DC.T 11T3..				
2020 K11	●	●	20	20	125	25					
2525 M11	●	●	25	25	150	32					
3232 P11	●	●	32	32	170	40					

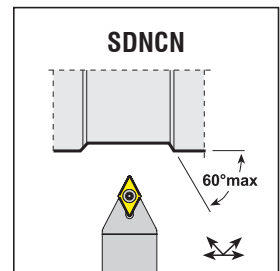
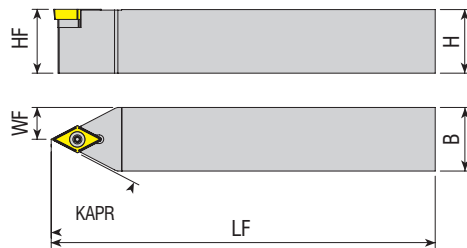
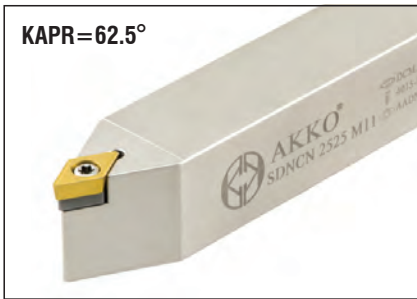

Takım Kodu Ordering Code Код для заказа	Stok Stock Наличие		Takım Ölçüleri (mm) Dimension (mm) Размеры (мм)				Kesici Uç Insert Пластина	Yedek Parçaları / Spare Parts / Запасные части			
			HF=H	B	LF	WF		Sıkma Vidası Screw Зажимной винт	Altılık Shim Опорная пластина	Altılık Vidası Shim Screw Винт опорной пластины	Tork Anahtar Torx Key Торх Ключ
SDNCN 0808 E07	●		08	08	70	4	DC.T 0702..				
1010 E07	●		10	10	70	5					
1212 F07	●		12	12	80	6					
1616 H07	●		16	16	100	8					
1616 H11	●		16	16	100	8	DC.T 11T3..				
2020 K11	●		20	20	125	10					
2525 M11	●		25	25	150	12.5					
3232 P11	●		32	32	170	16					

R: Sağ / Right / Правый L: Sol / Left / Левый
● Stokta / In Stock / В наличии ○ Stokta Yok / Non Stock Item / Нет в наличии

Sipariş Örneği/Ordering Example/Образец заказа
1 ad./pcs./шт. SDJCR 0808 E07

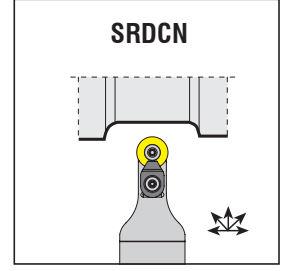
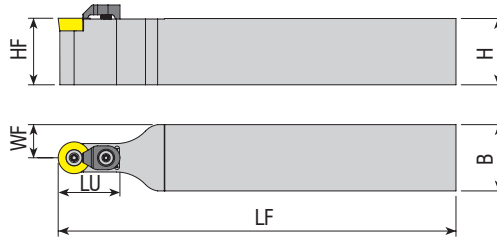
Takım Kodu
Ordering Code
 Код для заказа

 Stok
 Stock
 Наличие

 Takım Ölçüleri (mm)
 Dimension (mm)
 Размеры (мм)

 Kesici Uç
 Insert
 Пластина

Yedek Parçaları / Spare Parts / Запасные части

 Sıkma Vidası
 Screw
 Зажимной винт

 Altlık
 Shim
 Опорная пластина

 Altlık Vidası
 Shim Screw
 Винт опорной пластины

 Baskı Parçası
 Wedge Clamp
 Прижим

 Baskı Vidası
 Clamp Screw
 Зажимной винт

 Tork Anahtar
 Torx Key
 Торк Ключ

HF=H B LF LU WF

SRDCN 1616 H06

●

16

16

100

15

8

RC.T 0602..

3008-M2.5x6

-

-

-

-

80-T08

2020 K06

●

20

20

125

17

10

2525 M06

●

25

25

150

17

12.5

1616 H08C

●

16

16

100

15

8

2020 K08C

●

20

20

125

20

10

2525 M08C

●

25

25

150

20

12.5

1616 H10C

●

16

16

100

20

8

2020 K10C

●

20

20

125

20

10

2525 M10C

●

25

25

150

20

12.5

3232 P10C

●

32

32

170

20

16

2020 K12C

●

20

20

125

22

10

2525 M12C

●

25

25

150

22

12.5

3232 P12C

●

32

32

170

22

16

2525 M16C

●

25

25

150

32

12.5

3232 P16C

●

32

32

170

35

16

2525 M20C

●

25

25

150

32

12.5

3232 P20C

●

32

32

170

40

16

3232 P25C

●

32

32

170

40

16

3232 P32C

●

32

32

170

45

16

RC.T 3209..

1904-M8x1x20

-

-

ACK-09

AAV-05-M6x15

AAL-05-4

R: Sağ / Right / Правый L: Sol / Left / Левый

● Stokta / In Stock / В наличии ○ Stokta Yok / Non Stock Item / Нет в наличии

Sipariş Örneği/Ordering Example/Образец заказа

1 ad./pcs./шт. SRDCN 1616 H06



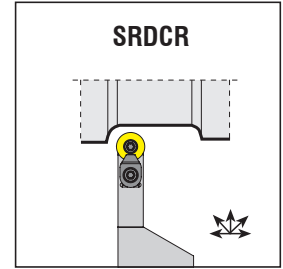
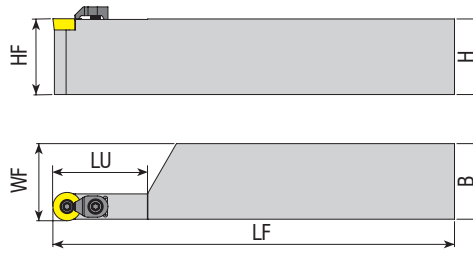

Takım Kodu
Ordering Code
Код для заказа

Stok Stock Наличие	Takım Ölçüleri (mm) Dimension (mm) Размеры (мм)						Kesici Uç Insert Пластина	Yedek Parçaları / Spare Parts / Запасные части						
	R	L	HF=H	B	LF	LU		WF	Sıkma Vidası Screw Зажимной винт	Altlık Shim Опорная пластина	Altlık Vidası Shim Screw Винт опорной пластины	Baskı Parçası Wedge Clamp Прижим	Baskı Vidası Clamp Screw Зажимной винт	Tork Anahtar Torx Key Торх Ключ
SRDCR/L 3232 T06	●	●	32	32	300	20	32.35	RC.T 0602..	3008-M2.5x6	-	-	-	-	80-T08
3232 P12C	●	●	32	32	170	40	32.65	RC.T 1204..	4015-M3.5x11			ACK-05	4015-M4x11	80-T15

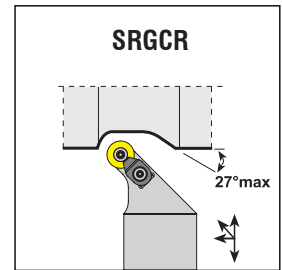
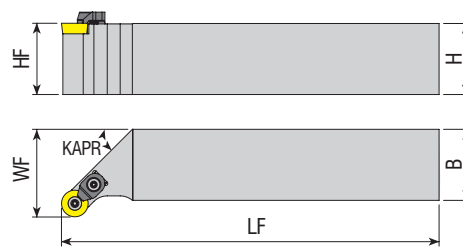

Takım Kodu
Ordering Code
Код для заказа

Stok Stock Наличие	Takım Ölçüleri (mm) Dimension (mm) Размеры (мм)						Kesici Uç Insert Пластина	Yedek Parçaları / Spare Parts / Запасные части					
	R	L	HF=H	B	LF	WF		Sıkma Vidası Screw Зажимной винт	Altlık Shim Опорная пластина	Altlık Vidası Shim Screw Винт опорной пластины	Baskı Parçası Wedge Clamp Прижим	Baskı Vidası Clamp Screw Зажимной винт	Tork Anahtar Torx Key Торх Ключ
SRGCR/L 1616 H06	●	●	16	16	100	20	RC.T 0602..	3008-M2.5x6	-	-	-	-	80-T08
2020 K06	●	●	20	20	125	25							
1616 H08C	●	●	16	16	100	20							
2020 K08C	●	●	20	20	125	25	RC.T 0803..	3008-M3x8	-	-	ACK-15	4015-M3.5x11	80-T15
2525 M08C	●	●	25	25	150	32							
1616 H10C	●	●	16	16	100	20	RC.T 10T3..	4015-M3.5x11	-	-	ACK-05	4015-M4x11	80-T15
2020 K10C	●	●	20	20	125	25							
2525 M10C	●	●	25	25	150	32							
3232 P10C	●	●	32	32	170	40							
2020 K12C	●	●	20	20	125	25	RC.T 1204..	4015-M3.5x11	-	ACK-05	4015-M4x11	80-T15	
2525 M12C	●	●	25	25	150	32							
3232 P12C	●	●	32	32	170	40							

R: Sağ / Right / Правый L: Sol / Left / Левый
● Stokta / In Stock / В наличии ○ Stokta Yok / Non Stock Item / Нет в наличии

Sipariş Örneği/Ordering Example/Образец заказа
1 ad./pcs./шт. SRDCR 3232 T06

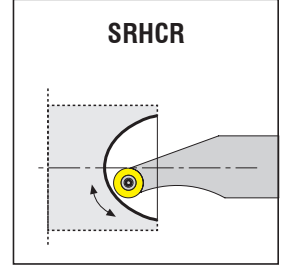
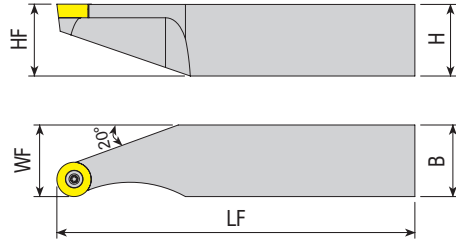

Takım Kodu
Ordering Code
Код для заказа

Stok Stock Наличие	Takım Ölçüleri (mm) Dimension (mm) Размеры (мм)						Kesici Uç Insert Пластина	Yedek Parçaları / Spare Parts / Запасные части				
	R	L	HF=H	B	LF	WF		Sikma Vidası Screw Зажимной винт	Altlık Shim Опорная пластина	Altlık Vidası Shim Screw Винт опорной пластины	Tork Anahtar Torx Key Торх Ключ	
SRHCR/L 2525 K06	●	○	25	25	125	25	32.5	RC.T 0602..	3008-M2.5x6	-	-	80-T08
2525 K08	●	●	25	25	125	25	32.5	RC.T 0803..	3008-M3x8	-	-	80-T08
2525 K10	●	●	25	25	125	25	36	RC.T 10T3..	4015-M3.5x11	-	-	80-T15
2525 K12	●	●	25	25	125	25	40	RC.T 1204..	-	-	-	80-T15
2525 K16	●	●	25	25	125	25	47.5	RC.T 1606..	1020-M5x11	-	-	80-T20

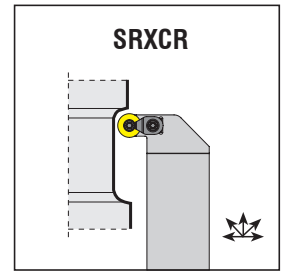
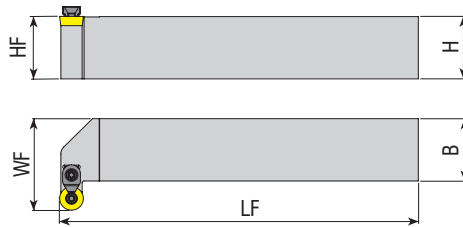

Takım Kodu
Ordering Code
Код для заказа

Stok Stock Наличие	Takım Ölçüleri (mm) Dimension (mm) Размеры (мм)						Kesici Uç Insert Пластина	Sikma Vidası Screw Зажимной винт	Altılık Shim Опорная пластина	Altılık Vidası Shim Screw Винт опорной пластины	Baskı Parçası Wedge Clamp Прижим	Baskı Vidası Clamp Screw Зажимной винт	Tork Anahtar Torx Key Торх Ключ
	R	L	HF=H	B	LF	WF					Baskı Parçası Wedge Clamp Прижим		
SRXCR/L 3232 X08C	●	●	32	32	220	47	RC.T 0803..	3008-M3x8	-	-	ACK-15	4015-M3.5x11	80-T08
3232 X10C	●	●	32	32	220	47	RC.T 10T3..	4015-M3.5x11	-	-	ACK-15	4015-M3.5x11	80-T15
3232 X12C	●	●	32	32	220	47	RC.T 1204..	-	-	ACK-05	4015-M4x11	80-T15	

R: Sağ / Right / Правый L: Sol / Left / Левый

● Stokta / In Stock / В наличии ○ Stokta Yok / Non Stock Item / Нет в наличии

Sipariş Örneği/Ordering Example/Образец заказа
1 ad./pcs./шт. SRHCR 2525 K06

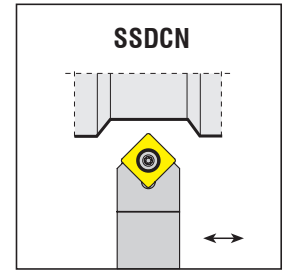
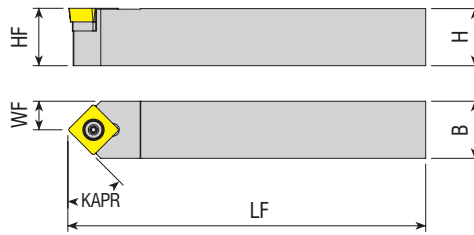
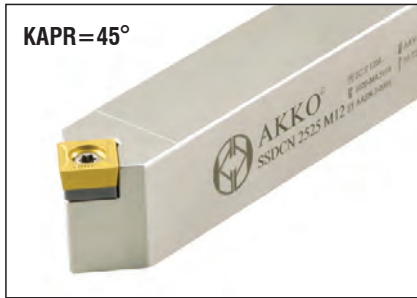

Yedek Parçaları / Spare Parts / Залпасные части

Takım Kodu Ordering Code Код для заказа	Stok Stock Наличие		Takım Ölçüleri (mm) Dimension (mm) Размеры (мм)				Kesici Uç Insert Пластина	Sıkma Vidası Screw Зажимной винт	Altlık Shim Опорная пластина	Altlık Vidası Shim Screw Винт опорной пластины	Tork Anahtar Torx Key Торх Ключ
	R	L	HF=H	B	LF	WF					
SSDCN 1212 F09	●		12	12	80	6	SC.T 09T3..	4015-M3.5x11	-	-	80-T15
1616 H09	●		16	16	100	8		4015-M3.5x14	AASN-2-0001	AAV-06-M3.5x11	
2020 K09	●		20	20	125	10		4020-M4.5x12		AAV-10-M4.5x8	
1616 H12	●		16	16	100	8	SC.T 1204..	1020-M4.5x16	AASN-2-0004	AAV-07-M4.5x13	80-T20
2020 K12	●		20	20	125	10					
2525 M12	●		25	25	150	12.5					

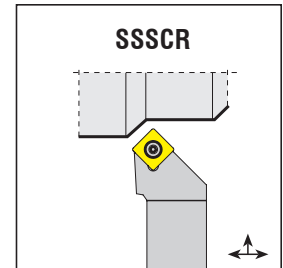
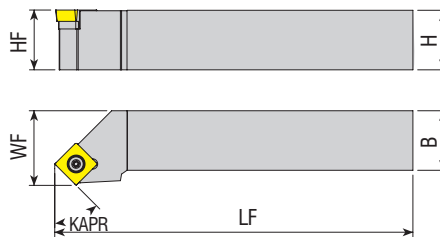
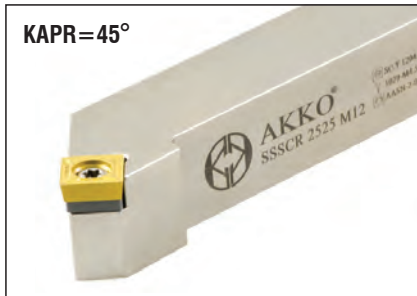

Yedek Parçaları / Spare Parts / Залпасные части

Takım Kodu Ordering Code Код для заказа	Stok Stock Наличие		Takım Ölçüleri (mm) Dimension (mm) Размеры (мм)				Kesici Uç Insert Пластина	Sıkma Vidası Screw Зажимной винт	Altlık Shim Опорная пластина	Altlık Vidası Shim Screw Винт опорной пластины	Tork Anahtar Torx Key Торх Ключ
	R	L	HF=H	B	LF	WF					
SSSCR/L 1212 F09	●	●	12	12	80	16	SC.T 09T3..	4015-M3.5x11	-	-	80-T15
1616 H09	●	●	16	16	100	20		4015-M3.5x14	AASN-2-0001	AAV-06-M3.5x11	
2020 K09	●	●	20	20	125	25		4020-M4.5x12		AAV-10-M4.5x8	
1616 H12	●	●	16	16	100	20	SC.T 1204..	1020-M4.5x16	AASN-2-0004	AAV-07-M4.5x13	80-T20
2020 K12	●	●	20	20	125	25					
2525 M12	●	●	25	25	150	32					

R: Sağ / Right / Правый L: Sol / Left / Левый

● Stokta / In Stock / В наличии ○ Stokta Yok / Non Stock Item / Нет в наличии

Sipariş Örneği/Ordering Example/Образец заказа
1 ad./pcs./шт. SSDCN 1212 F09

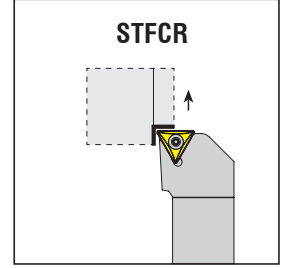
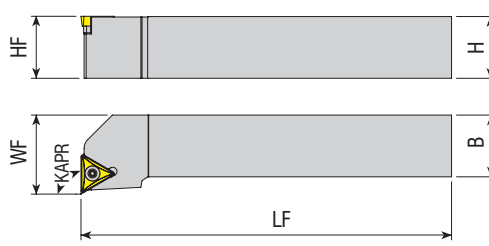

Takım Kodu
Ordering Code
Код для заказа

Stok Stock Наличие	Takım Ölçüleri (mm) Dimension (mm) Размеры (мм)					Kesici Uç Insert Пластина	Yedek Parçaları / Spare Parts / Запасные части				
	R	L	HF=H	B	LF		WF	Sikma Vidası Screw Зажимной винт	Altlık Shim Опорная пластина	Altlık Vidası Shim Screw Винт опорной пластины	Tork Anahtar Torx Key Торх Ключ
STFGR/L 0808 E09	○	○	08	08	70	10	TC.T 0902..	3007-M2.2x5	-	-	80-T07
1010 E09	●	●	10	10	70	12					
1212 F11	●	●	12	12	80	16					
1616 H11	●	●	16	16	100	20	TC.T 1102..	4008-M2.5x6	-	-	80-T08
1616 H16	●	●	16	16	100	20					
2020 K16	●	●	20	20	125	25	TC.T 16T3..	4015-M3.5x14	AATN-2-0001	AAV-06-M3.5x11	80-T15
2525 M16	●	●	25	25	150	32					
3232 P16	●	●	32	32	170	40					

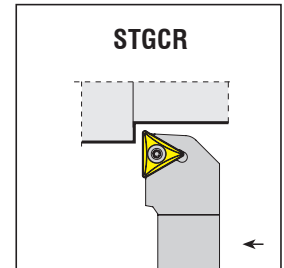
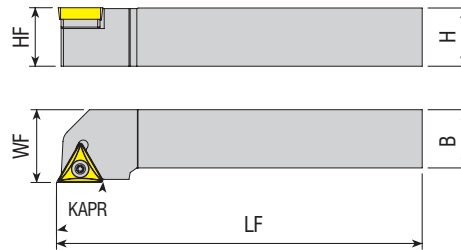

Takım Kodu
Ordering Code
Код для заказа

Stok Stock Наличие	Takım Ölçüleri (mm) Dimension (mm) Размеры (мм)					Kesici Uç Insert Пластина	Yedek Parçaları / Spare Parts / Запасные части				
	R	L	HF=H	B	LF		WF	Sikma Vidası Screw Зажимной винт	Altlık Shim Опорная пластина	Altlık Vidası Shim Screw Винт опорной пластины	Tork Anahtar Torx Key Торх Ключ
STGCR/L 0808 E09	●	●	08	08	70	10	TC.T 0902..	3007-M2.2x5	-	-	80-T07
1010 E09	●	●	10	10	70	12					
1212 F11	●	●	12	12	80	16					
1616 H11	●	●	16	16	100	20	TC.T 1102..	4008-M2.5x6	-	-	80-T08
1616 H16	●	●	16	16	100	20					
2020 K16	●	●	20	20	125	25	TC.T 16T3..	4015-M3.5x14	AATN-2-0001	AAV-06-M3.5x11	80-T15
2525 M16	●	●	25	25	150	32					
3232 P16	●	●	32	32	170	40					

R: Sağ / Right / Правый L: Sol / Left / Левый
● Stokta / In Stock / В наличии ○ Stokta Yok / Non Stock Item / Нет в наличии

Sipariş Örneği/Ordering Example/Образец заказа
1 ad./pcs./шт. STFGR 0808 E09

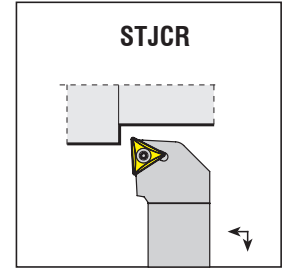
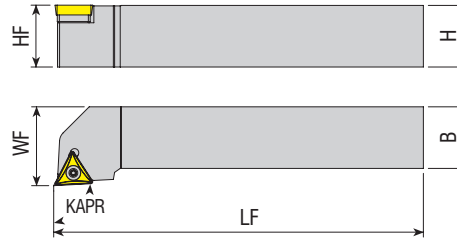
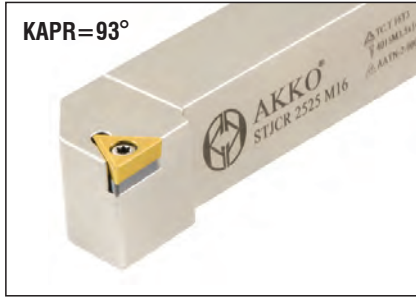

Takım Kodu
Ordering Code
Код для заказа

Stok Stock Наличие	Takım Ölçüleri (mm) Dimension (mm) Размеры (мм)					Kesici Uç Insert Пластина	Yedek Parçaları / Spare Parts / Запасные части			
	R	L	HF=H	B	LF		WF	Sıkma Vidası Screw Зажимной винт	Altık Shim Опорная пластина	Altık Vidası Shim Screw Винт опорной пластины
●	●	08	08	70	10	TC.T 0902..	3007-M2.2x5	-	-	80-T07
●	●	10	10	70	12					
●	●	12	12	80	16					
●	●	16	16	100	20	TC.T 1102..	4008-M2.5x6	-	-	80-T08
●	●	16	16	100	20					
●	●	20	20	125	25	TC.T 16T3..	4015-M3.5x14	AATN-2-0001	AAV-06-M3.5x11	80-T15
●	●	25	25	150	32					
●	●	32	32	170	40					
●	●	32	32	170	40					

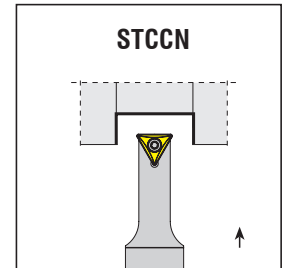
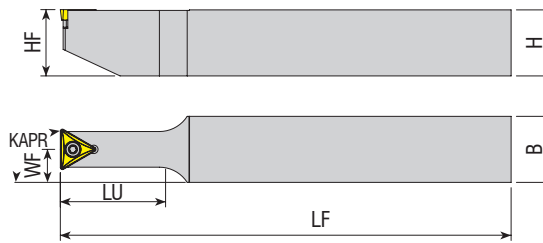

Takım Kodu
Ordering Code
Код для заказа

Stok Stock Наличие	Takım Ölçüleri (mm) Dimension (mm) Размеры (мм)						Kesici Uç Insert Пластина	Yedek Parçaları / Spare Parts / Запасные части			
	HF=H	B	LF	WF	LU	Sıkma Vidası Screw Зажимной винт		Altık Shim Опорная пластина	Altık Vidası Shim Screw Винт опорной пластины	Tork Anahtar Torx Key Торх Ключ	
●	20	20	140	10	50	TC.T 1102..	4008-M2.5x6	-	-	80-T08	
●	16	16	125	8	24						
●	20	20	150	10	30	TC.T 16T3..	4015-M3.5x14	AATN-2-0001	AAV-06-M3.5x11	80-T15	
●	25	25	170	12.5	37.5						
●	32	32	200	16	48						
●	25	25	170	12.5	80	TC.T 2204..	4020-M4.5x12	-	-	80-T20	

R: Sağ / Right / Правый L: Sol / Left / Левый

● Stokta / In Stock / В наличии ○ Stokta Yok / Non Stock Item / Нет в наличии

Sipariş Örneği/Ordering Example/Образец заказа

1 ad./pcs./шт. STJCR 0808 E09

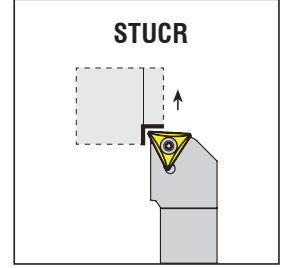
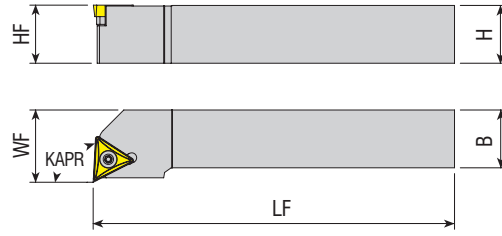

Takım Kodu Ordering Code Код для заказа	Stok Stock Наличие		Takım Ölçüleri (mm) Dimension (mm) Размеры (мм)				Kesici Uç Insert Пластина	Yedek Parçaları / Spare Parts / Запасные части			
	R	L	HF=H	B	LF	WF		Sıkma Vidası Screw Зажимной винт	Altlık Shim Опорная пластина	Altlık Vidası Shim Screw Винт опорной пластины	Tork Anahtar Torx Key Торх Ключ
STUCR/L 0808 E09	●	●	08	08	70	10					80-T07
1010 E09	●	●	10	10	70	12					
1212 F11	●	●	12	12	80	16					
1616 H11	●	●	16	16	100	20	TC.T 1102..	4008-M2.5x6	-	-	80-T08
1616 H16	○	○	16	16	100	20					
2020 K16	●	●	20	20	125	25	TC.T 16T3..	4015-M3.5x14	AATN-2-0001	AAV-06-M3.5x11	80-T15
2525 M16	●	●	25	25	150	32					
3232 P16	●	●	32	32	170	40					

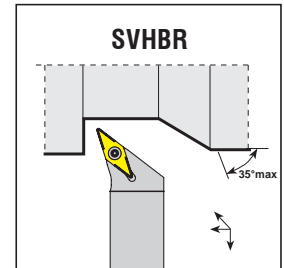
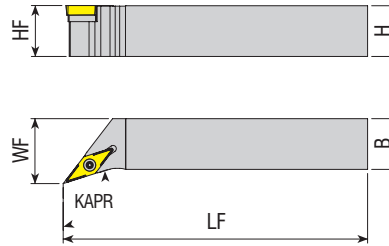
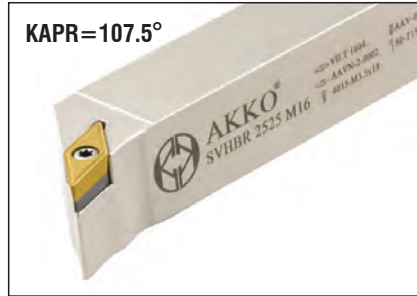

Takım Kodu Ordering Code Код для заказа	Stok Stock Наличие		Takım Ölçüleri (mm) Dimension (mm) Размеры (мм)				Kesici Uç Insert Пластина	Yedek Parçaları / Spare Parts / Запасные части			
	R	L	HF=H	B	LF	WF		Sıkma Vidası Screw Зажимной винт	Altlık Shim Опорная пластина	Altlık Vidası Shim Screw Винт опорной пластины	Tork Anahtar Torx Key Торх Ключ
SVHBR/L 1212 F11	●	●	12	12	80	16		4008-M2.5x6	-	-	80-T08
1616 H11	●	●	16	16	100	20					
2020 K11	●	●	20	20	125	25					
2020 K16	●	●	20	20	125	25	VB.T 1604..	4015-M3.5x14	AAVN-2-0002	AAV-06-M3.5x11	80-T15
2525 M16	●	●	25	25	150	32					
3232 P16	●	●	32	32	170	40					

R: Sağ / Right / Правый L: Sol / Left / Левый
● Stokta / In Stock / В наличии ○ Stokta Yok / Non Stock Item / Нет в наличии

Sipariş Örneği/Ordering Example/Образец заказа
1 ad./pcs./шт. STUCR 0808 E09

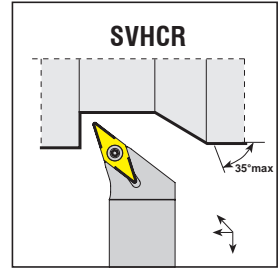
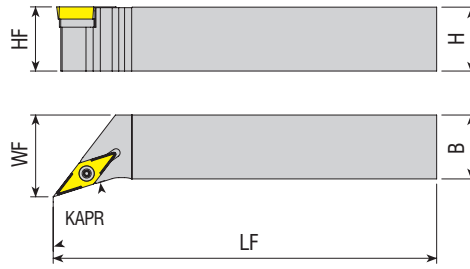

Takım Kodu Ordering Code Код для заказа	Stok Stock Наличие		Takım Ölçüleri (mm) Dimension (mm) Размеры (мм)				Kesici Uç Insert Пластина	Yedek Parçaları / Spare Parts / Запасные части			
	R	L	HF=H	B	LF	WF		Sıkma Vidası Screw Зажимной винт	Altlık Shim Опорная пластина	Altlık Vidası Shim Screw Винт опорной пластины	Tork Anahtar Torx Key Торх Ключ
SVHCR/L 1212 F11	●	●	12	12	80	16	VC.T 1103..	4008-M2.5x6	-	-	80-T08
1616 H11	●	●	16	16	100	20					
2020 K11	●	●	20	20	125	25					
2020 K16	●	●	20	20	125	25	VC.T 1604..	4015-M3.5x14	AAVN-2-0002	AAV-06-M3.5x11	80-T15
2525 M16	●	●	25	25	150	32					
3232 P16	●	●	32	32	170	40					

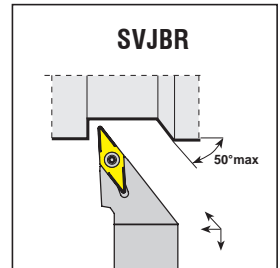
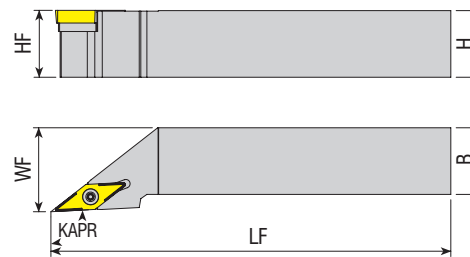

Takım Kodu Ordering Code Код для заказа	Stok Stock Наличие		Takım Ölçüleri (mm) Dimension (mm) Размеры (мм)				Kesici Uç Insert Пластина	Yedek Parçaları / Spare Parts / Запасные части			
	R	L	HF=H	B	LF	WF		Sıkma Vidası Screw Зажимной винт	Altlık Shim Опорная пластина	Altlık Vidası Shim Screw Винт опорной пластины	Tork Anahtar Torx Key Торх Ключ
SVJBR/L 1212 F11	●	●	12	12	80	16	VB.T 1103..	4008-M2.5x6	-	-	80-T08
1616 H11	●	●	16	16	100	20					
2020 K11	●	●	20	20	125	25					
1616 H16	●	●	16	16	100	20	VB.T 1604..	4015-M3.5x14	AAVN-2-0002	AAV-06-M3.5x11	80-T15
2020 K16	●	●	20	20	125	25					
2525 M16	●	●	25	25	150	32					
3232 P16	●	●	32	32	170	40					

R: Sağ / Right / Правый L: Sol / Left / Левый
● Stokta / In Stock / В наличии ○ Stokta Yok / Non Stock Item / Нет в наличии

Sipariş Örneği/Ordering Example/Образец заказа
1 ad./pcs./шт. SVHCR 1212 F11

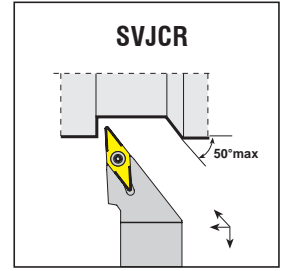
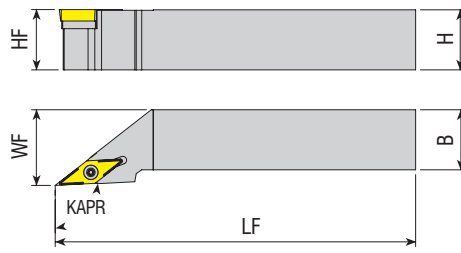

Takım Kodu Ordering Code Код для заказа	Stok / Stock / Наличие						Kesici Uç Insert Пластина	Yedek Parçaları / Spare Parts / Запасные части				
	Takım Ölçüleri (mm) Dimension (mm) Размеры (мм)							Sıkma Vidası Screw Зажимной винт	Altlık Shim Опорная пластина	Altlık Vidası Shim Screw Винт опорной пластины	Tork Anahtar Torx Key Торх Ключ	
	R	L	HF=H	B	LF	WF						
SVJCR/L 1212 F11	●	●	12	12	80	16	VC.T 1103..	4008-M2.5x6	-	-	80-T08	
1616 H11	●	●	16	16	100	20						
2020 K11	●	●	20	20	125	25						
2525 M11	●	●	25	25	150	32	VC.T 1604..	4015-M3.5x11	AAVN-2-0002	AAV-06-M3.5x11	80-T15	
1212 F16	●	●	12	12	80	16						
2020 K16	●	●	20	20	125	25						
2525 M16	●	●	25	25	150	32						
3232 P16	●	●	32	32	170	40						

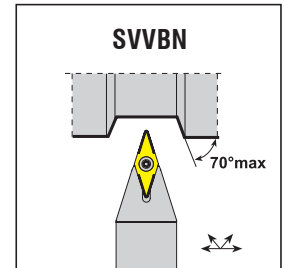
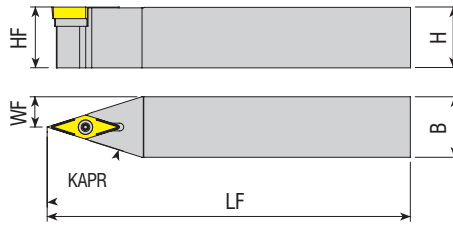

Takım Kodu Ordering Code Код для заказа	Stok / Stock / Наличие						Kesici Uç Insert Пластина	Yedek Parçaları / Spare Parts / Запасные части				
	Takım Ölçüleri (mm) Dimension (mm) Размеры (мм)							Sıkma Vidası Screw Зажимной винт	Altlık Shim Опорная пластина	Altlık Vidası Shim Screw Винт опорной пластины	Tork Anahtar Torx Key Торх Ключ	
	R	L	HF=H	B	LF	WF						
SVVBN 1212 F11	●		12	12	80	06	VB.T 1103..	4008-M2.5x6	-	-	80-T08	
1616 H11	●		16	16	100	08						
2020 K11	●		20	20	125	10						
2020 K16	●		20	20	125	10	VB.T 1604..	4015-M3.5x14	AAVN-2-0002	AAV-06-M3.5x11	80-T15	
2525 M16	●		25	25	150	12.5						
3232 P16	●		32	32	170	16						

R: Sağ / Right / Правый L: Sol / Left / Левый
● Stokta / In Stock / В наличии ○ Stokta Yok / Non Stock Item / Нет в наличии

Sipariş Örneği/Ordering Example/Образец заказа
1 ad./pcs./шт. SVJCR 1212 F11

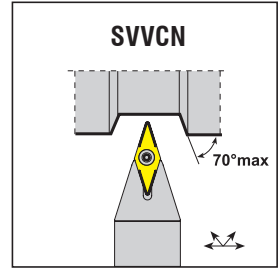
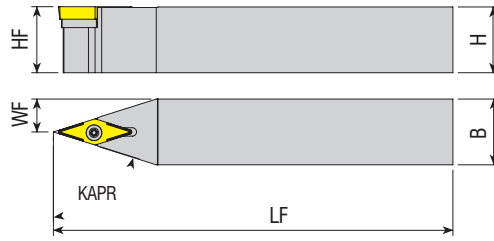

Takım Kodu Ordering Code Код для заказа	Stok Stock Наличие	Takım Ölçüleri (mm) Dimension (mm) Размеры (мм)				Kesici Uç Insert Пластина	Yedek Parçaları / Spare Parts / Запасные части			
		HF=H	B	LF	WF		Sikma Vidası Screw Зажимной винт	Altılık Shim Опорная пластина	Altılık Vidası Shim Screw Винт опорной пластины	Tork Anahtar Torx Key Торх Ключ
SVVCN 1212 F11	●	12	12	80	06	VC.T 1103..	4008-M2.5x6	-	-	80-T08
1616 H11	●	16	16	100	08					
2020 K11	●	20	20	125	10					
2020 K16	●	20	20	125	10	VC.T 1604..	4015-M3.5x14	AAVN-2-0002	AAV-06-M3.5x11	80-T15
2525 M16	●	25	25	150	12.5					
3232 P16	●	32	32	170	16					

S-SİSTEM İSVİÇRE TİPİ KAYAR OTOMAT MAKİNA TAKIMLARI
S-SYSTEM TOOLS FOR SWISS TYPE SLIDING AUTOMATIC LATHES
S-ТИП ДЕРЖАВКИ ДЛЯ СТАНКОВ АВТОМАТОВ ШВЕЙЦАРСКОГО ТИПА

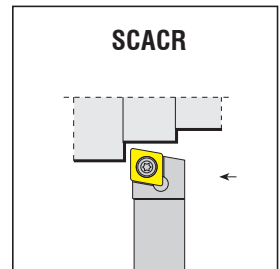
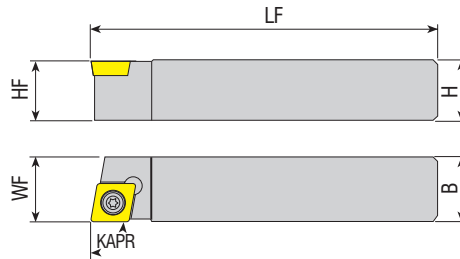
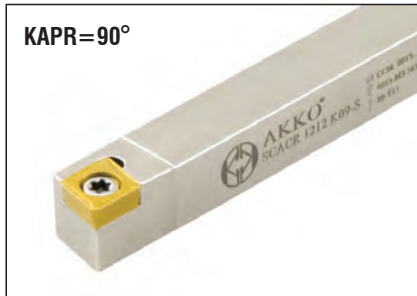

Takım Kodu Ordering Code Код для заказа	Stok Stock Наличие	Takım Ölçüleri (mm) Dimension (mm) Размеры (мм)				Kesici Uç Insert Пластина	Yedek Parçaları / Spare Parts / Запасные части					
		R	L	HF=H	B		LF	WF	Sikma Vidası Screw Зажимной винт	Altılık Shim Опорная пластина	Altılık Vidası Shim Screw Винт опорной пластины	Tork Anahtar Torx Key Торх Ключ
SCACR/L 0808 X06-S	● ●	08	08	115	08	CC.T 0602..	4008-M2.5x6	-	-	80-T08		
1010 K06-S	● ○	10	10	125	10							
1212 G06-S	● ○	12	12	90	12							
1212 K06-S	● ○	12	12	125	12							
1616 F06-S	○ ○	16	16	75	16							
1616 K06-S	○ ○	16	16	125	16							
1212 G09-S	○ ○	12	12	90	12	CC.T 09T3..	4015-M3.5x11	-	-	80-T15		
1212 K09-S	● ●	12	12	125	12							
1616 F09-S	○ ○	16	16	75	16							
1616 K09-S	● ●	16	16	125	16							
2020 K09-S	● ●	20	20	125	20							

R: Sağ / Right / Правый L: Sol / Left / Левый
● Stokta / In Stock / В наличии ○ Stokta Yok / Non Stock Item / Нет в наличии

Sipariş Örneği/Ordering Example/Образец заказа
1 ad./pcs./шт. SVVCN 1212 F11

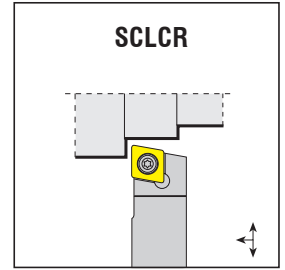
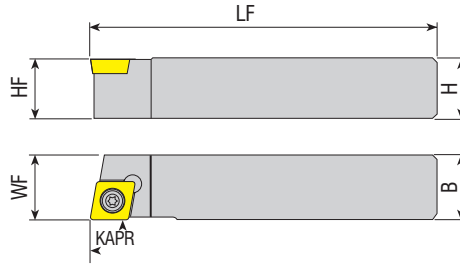
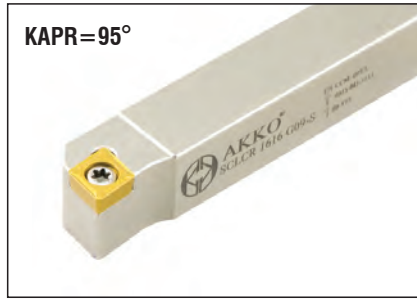

Takım Kodu Ordering Code Код для заказа	Stok Stock Наличие		Takım Ölçüleri (mm) Dimension (mm) Размеры (мм)				Kesici Uç Insert Пластина	Yedek Parçaları / Spare Parts / Запасные части								
	R	L	HF=H	B	LF	WF		Sıkma Vidası Screw Зажимной винт	Altlık Shim Опорная пластина	Altlık Vidası Shim Screw Винт опорной пластины	Tork Anahtar Torx Key Торх Ключ					
	●	○														
SCLCR/L 0808 X06-S	●	●	08	08	115	08	CC.T 0602..	4008-M2.5x6	-	-	80-T08					
1010 X06-S	●	○	10	10	115	10										
1212 G06-S	●	●	12	12	90	12										
1212 X06-S	●	○	12	12	130	12										
1212 K06-S	○	●	12	12	125	12										
1616 F06-S	●	○	16	16	75	16										
1616 X06-S	●	○	16	16	130	16										
1212 G09-S	●	●	12	12	90	12						CC.T 09T3..	4015-M3.5x11	-	-	80-T15
1212 X09-S	●	○	12	12	130	12										
1616 F09-S	●	○	16	16	75	16										
1616 G09-S	●	○	16	16	90	16										
1616 X09-S	●	○	16	16	115	16										
2020 X09-S	●	○	20	20	120	20										

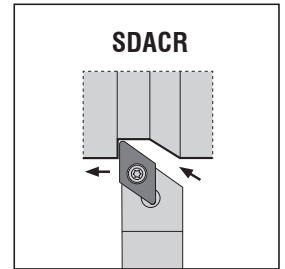
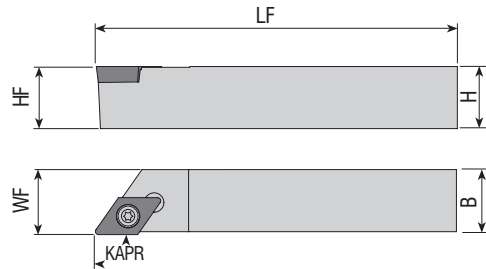
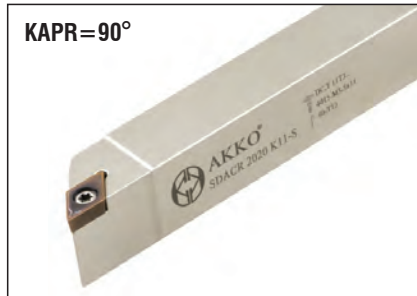

Takım Kodu Ordering Code Код для заказа	Stok Stock Наличие		Takım Ölçüleri (mm) Dimension (mm) Размеры (мм)				Kesici Uç Insert Пластина	Yedek Parçaları / Spare Parts / Запасные части				
	R	L	HF=H	B	LF	WF		Sıkma Vidası Screw Зажимной винт	Altlık Shim Опорная пластина	Altlık Vidası Shim Screw Винт опорной пластины	Tork Anahtar Torx Key Торх Ключ	
	●	○										
SDACR/L 0808 X07-S	●	●	08	08	115	08	DC.T 0702..	4008-M2.5x6	-	-	80-T08	
1010 K07-S	●	●	10	10	125	10						
1212 G07-S	○	○	12	12	90	12						
1212 K07-S	●	●	12	12	125	12						
1616 F07-S	●	○	16	16	75	16						
1616 K07-S	●	●	16	16	125	16						DC.T 11T3..
1212 G11-S	○	○	12	12	90	12						
1212 K11-S	●	●	12	12	125	12						
1616 F11-S	●	○	16	16	75	16						
1616 K11-S	●	●	16	16	125	16						
2020 K11-S	●	●	20	20	125	20						

R: Sağ / Right / Правый L: Sol / Left / Левый
 ● Stokta / In Stock / В наличии ○ Stokta Yok / Non Stock Item / Нет в наличии

Sipariş Örneği/Ordering Example/Образец заказа
 1 ad./pcs./шт. SCLCR 0808 X06-S

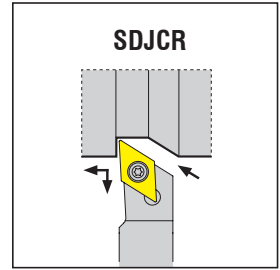
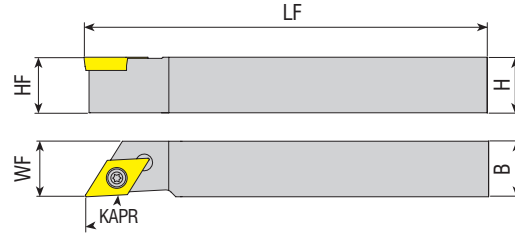
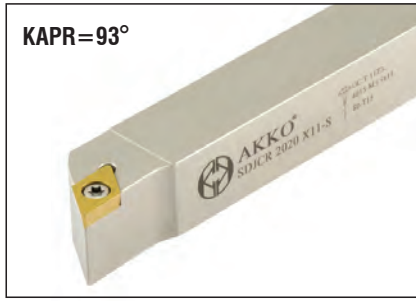

Takım Kodu Ordering Code Код для заказа	Stok Stock Наличие		Takım Ölçüleri (mm) Dimension (mm) Размеры (мм)				Kesici Uç Insert Пластина	Yedek Parçaları / Spare Parts / Запасные части			
	R	L	HF=H	B	LF	WF		Sıkma Vidası Screw Зажимной винт	Altlık Shim Опорная пластина	Altlık Vidası Shim Screw Винт опорной пластины	Tork Anahtar Torx Key Торх Ключ
SDJCR/L 0808 X07-S	●	○	08	08	115	08	DC.T 0702..	4008-M2.5x6	-	-	80-T08
1010 X07-S	●	●	10	10	115	10					
1212 G07-S	●	○	12	12	90	12					
1212 X07-S	●	●	12	12	130	12					
1616 F07-S	●	○	16	16	75	16					
1616 X07-S	●	○	16	16	130	16					
2020 X07-S	●	○	20	20	120	20					
1212 G11-S	●	○	12	12	90	12	DC.T 11T3..	4015-M3.5x11	-	-	80-T15
1212 X11-S	●	●	12	12	130	12					
1212 K11-S	●	●	12	12	125	12					
1616 F11-S	●	○	16	16	75	16					
1616 X11-S	●	●	16	16	130	16					
1616 K11-S	●	●	16	16	125	16					
2020 X11-S	●	○	20	20	120	20					

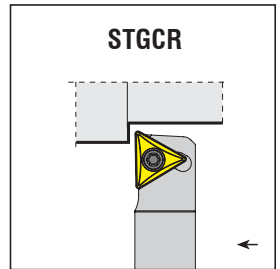
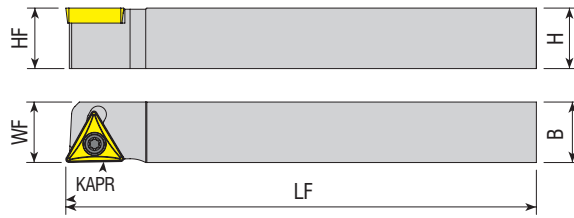

Takım Kodu Ordering Code Код для заказа	Stok Stock Наличие		Takım Ölçüleri (mm) Dimension (mm) Размеры (мм)				Kesici Uç Insert Пластина	Yedek Parçaları / Spare Parts / Запасные части			
	R	L	HF=H	B	LF	WF		Sıkma Vidası Screw Зажимной винт	Altlık Shim Опорная пластина	Altlık Vidası Shim Screw Винт опорной пластины	Tork Anahtar Torx Key Торх Ключ
STGCR/L 1216 K11-S	●	○	12	16	125	16	TC.T 1102..	4008-M2.5x6	-	-	80-T08
1616 K11-S	●	○	16	16	125	16					
1216 K16-S	●	○	12	16	125	16	TC.T 16T3..	4015-M3.5x11	-	-	80-T15
1616 K16-S	●	○	16	16	125	16					

R: Sağ / Right / Правый L: Sol / Left / Левый
● Stokta / In Stock / В наличии ○ Stokta Yok / Non Stock Item / Нет в наличии

Sipariş Örneği/Ordering Example/Образец заказа
1 ad./pcs./шт. SDJCR 0808 X07-S

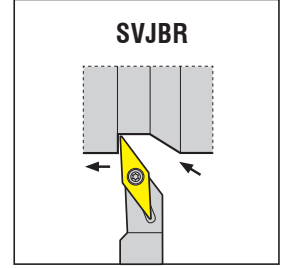
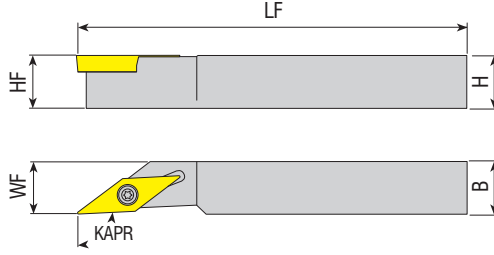

Takım Kodu
Ordering Code
Код для заказа

Stok Stock Наличие	Takım Ölçüleri (mm) Dimension (mm) Размеры (мм)					Kesici Uç Insert Пластина	Yedek Parçaları / Spare Parts / Запасные части			
	R	L	HF=H	B	LF		WF	Sıkma Vidası Screw Зажимной винт	Altlık Shim Опорная пластина	Altlık Vidası Shim Screw Винт опорной пластины
						VB.T 1103..	4008-M2.5x6	-	-	80-T08

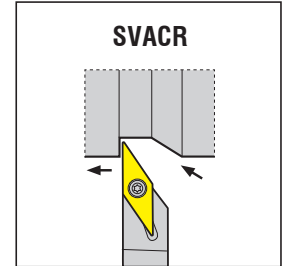
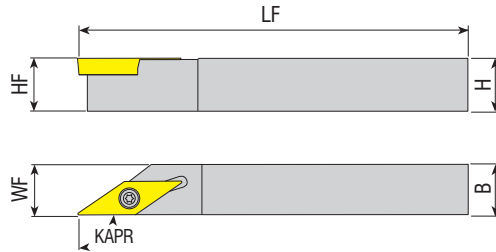

Takım Kodu
Ordering Code
Код для заказа

Stok Stock Наличие	Takım Ölçüleri (mm) Dimension (mm) Размеры (мм)					Kesici Uç Insert Пластина	Yedek Parçaları / Spare Parts / Запасные части			
	R	L	HF=H	B	LF		WF	Sıkma Vidası Screw Зажимной винт	Altlık Shim Опорная пластина	Altlık Vidası Shim Screw Винт опорной пластины
						VC.T 1103..	4008-M2.5x6	-	-	80-T08
						VC.T 1604..	4015-M3.5x11			80-T15

R: Sağ / Right / Правый L: Sol / Left / Левый
● Stokta / In Stock / В наличии ○ Stokta Yok / Non Stock Item / Нет в наличии

Sipariş Örneği/Ordering Example/Образец заказа
1 ad./pcs./шт. SVJBR 1616 K11-S

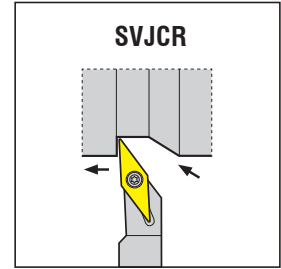
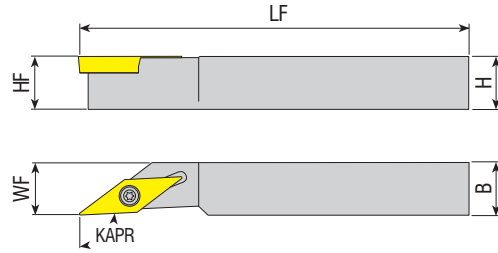

Takım Kodu Ordering Code Код для заказа	Stok Stock Наличие		Takım Ölçüleri (mm) Dimension (mm) Размеры (мм)				Kesici Uç Insert Пластина	Yedek Parçaları / Spare Parts / Запасные части			
	R	L	HF=H	B	LF	WF		Sıkma Vidası Screw Зажимной винт	Altlık Shim Опорная пластина	Altlık Vidası Shim Screw Винт опорной пластины	Tork Anahtar Torx Key Торх Ключ
SVJCR/L 0808 X11-S	●	○	08	08	115	08	VC.T 1103..	4008-M2.5x6	-	-	80-T08
1010 K11-S	●	○	10	10	125	10					
1212 G11-S	○	○	12	12	90	12					
1212 K11-S	●	●	12	12	125	12					
1616 F11-S	○	○	16	16	75	16					
1616 K11-S	●	○	16	16	125	16					
2020 K11-S	○	○	20	20	125	20					

SEC TOOLS

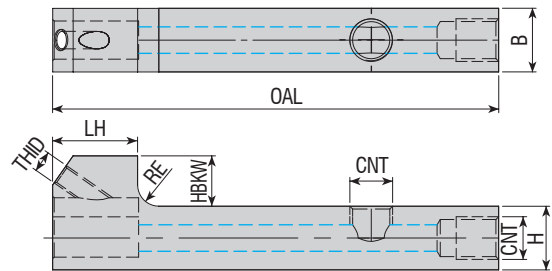

Takım Kodu Ordering Code Код для заказа	Stok Stock Наличие	Takım Ölçüleri (mm) Dimension (mm) Размеры (мм)								Yedek Parçaları / Spare Parts / Запасные части		
		H	B	RE	HBKW	LH	OAL	CNT	THID	Sızdırmaz Vida Threaded Pin Резьбовой Винт	Montaj Vidası Mounting Screw Монтажный винт	Anahtar Allen Key Ключ
ASTB-1212-L84-H	●	12	12	4	9.5	16	84	M8X1X5	M4x0.7	2704-M8X1X5	2503-M4x12-C	AAL-03-3
ASTB-1616-L90-H	●	16	16	1	5.5	16	90	M8X1X5	M4x0.7			

R: Sağ / Right / Правый L: Sol / Left / Левый

● Stokta / In Stock / В наличии ○ Stokta Yok / Non Stock Item / Нет в наличии

Sipariş Örneği/Ordering Example/Образец заказа

1 ad./pcs./шт. SVJCR 0808 X11-S



KAPR=93°

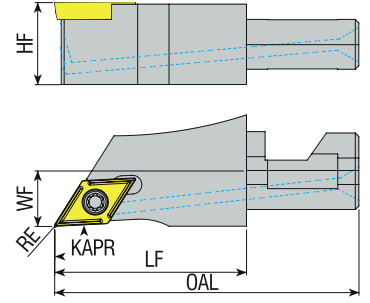

Takım Kodu Ordering Code Код для заказа	Stok Stock Наличие		Takım Ölçüleri (mm) Dimension (mm) Размеры (мм)				Kesici Uç Insert Пластина	Yedek Parçaları / Spare Parts / Запасные части		
	R	L	HF	WF	RE	LF		OAL	Sıkma Vidası Screw Зажимной винт	Tork Anahtar Torx Key Торх Ключ
SDJCR/L-12X43.3-07	●	●	11.8	8	0.2	27.3	43.3	DC.T 070202	4008-M2.5x6	80-T08
12X43.3-07-H	●	●	11.8	8	0.2	27.3	43.3			
16X43.3-07	●	●	15.8	8	0.2	27.3	43.3			
16X43.3-07-H	●	●	15.8	8	0.2	27.3	43.3			
12X43.3-11	●	●	11.8	8	0.2	27.3	43.3	DC.T 11T302	4015-M3.5x9	80-T15
12X43.3-11-H	●	●	11.8	8	0.2	27.3	43.3			
16X43.3-11	●	●	15.8	8	0.2	27.3	43.3			
16X43.3-11-H	●	●	15.8	8	0.2	27.3	43.3			



KAPR=93°

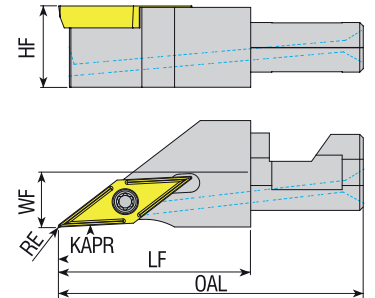

Takım Kodu Ordering Code Код для заказа	Stok Stock Наличие		Takım Ölçüleri (mm) Dimension (mm) Размеры (мм)				Kesici Uç Insert Пластина	Yedek Parçaları / Spare Parts / Запасные части		
	R	L	HF	WF	RE	LF		OAL	Sıkma Vidası Screw Зажимной винт	Tork Anahtar Torx Key Торх Ключ
SVJCR/L-12X43.3-11	●	●	11.8	8	0.2	27.3	43.3	VC.T 110302	4008-M2.5x6	80-T08
12X43.3-11-H	●	●	11.8	8	0.2	27.3	43.3			
16X43.3-11	●	●	15.8	8	0.2	27.3	43.3			
16X43.3-11-H	●	●	15.8	8	0.2	27.3	43.3			

R: Sağ / Right / Правый L: Sol / Left / Левый

● Stokta / In Stock / В наличии ○ Stokta Yok / Non Stock Item / Нет в наличии

Sipariş Örneği/Ordering Example/Образец заказа

1 ad./pcs./шт. SDJCR-12X43.3-07

new

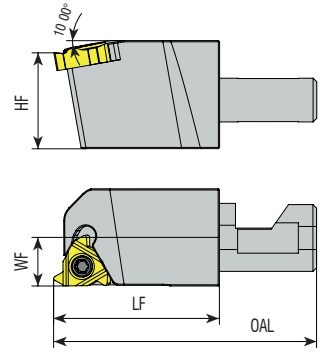

Takım Kodu
Ordering Code
Код для заказа

Stok Stock Наличие		Takım Ölçüleri (mm) Dimension (mm) Размеры (мм)					Kesici Uç Insert Пластина	Yedek Parçaları / Spare Parts / Запасные части						
		R	L	OAL	LF	WF		HF	Sıkma Vidası Screw Зажимной винт	Sağ Altlık Right Shim правая подкладная пластина	Sol Altlık Left Shim левая подкладная пластина	Altlık Vidası Shim Screw Винт опорной пластины	Altlık Vidası Pulu Shim Screw Ring Винт опорной пластины/пту	Tork Anahtar Torx Key Торкс Ключ
SER/L-12x43.3-11	● ●			43.3	27.3	8	11.8			-	-	-	-	80-T08
SER/L-16x43.3-11	● ●			43.3	27.3	8	15.8		4008-M2.5x6	-	-	-	-	80-T08
TER/L-16x43.3-16	● ●			43.3	27.3	8	15.8		1710-U5-40x12.2	ATS-16E	ATS-16I	AAV-11-U5-40x4.5	ABPL-03	80-T10

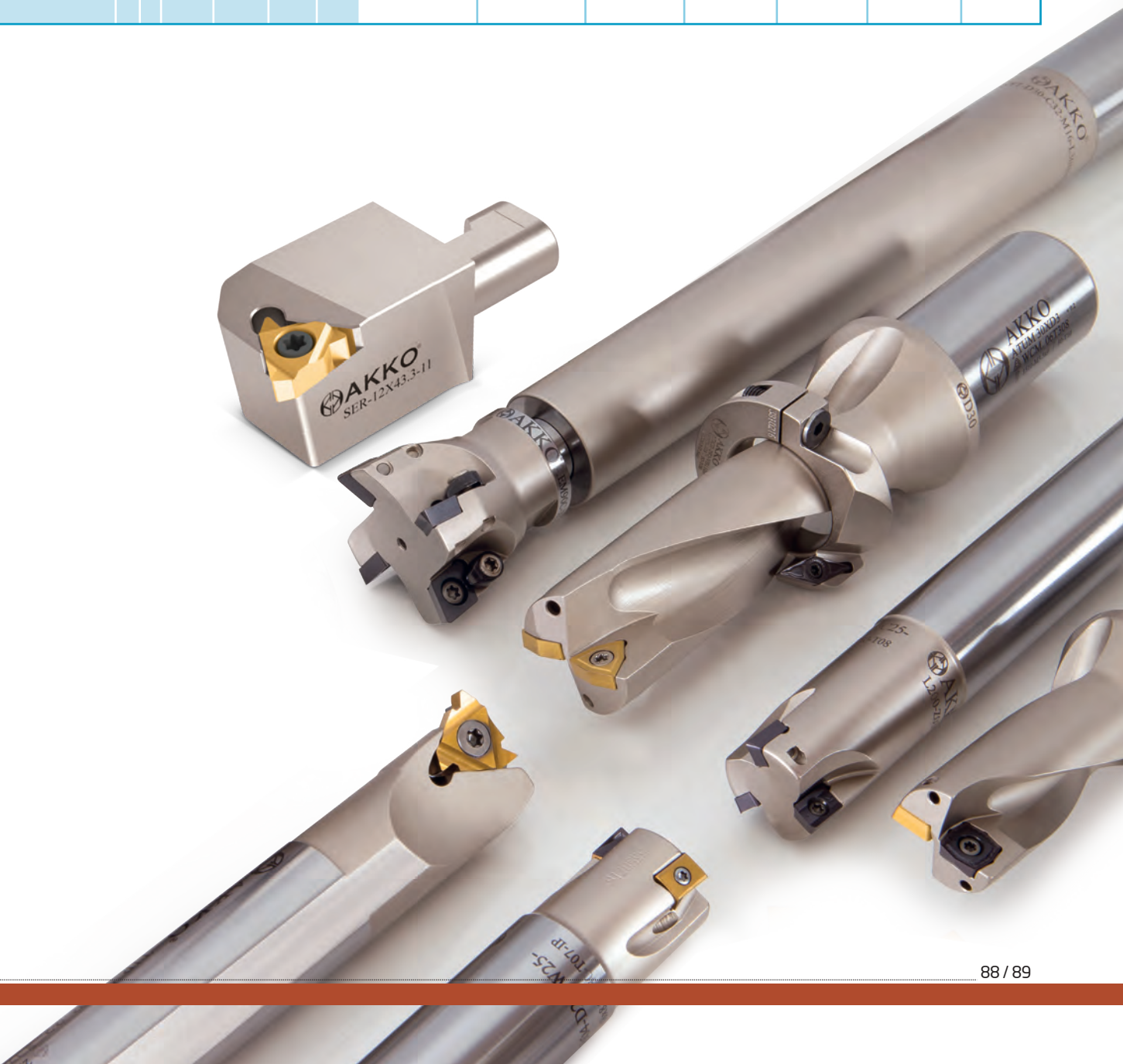

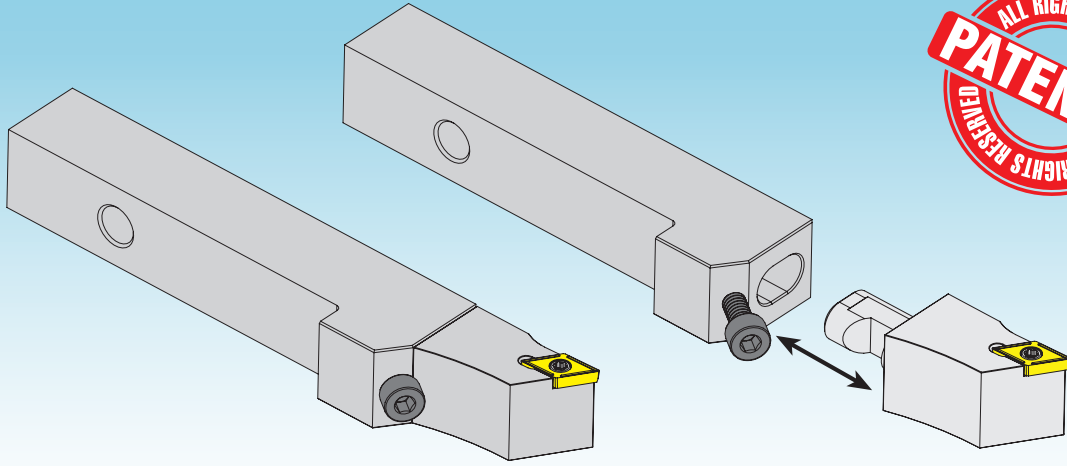

Takım tutucuyu, bağlama ünitesinden sökme zorunluğ u kalmadan hızlıca deęiřtirin!

Quick change, without having to remove the tool-holder from the gang !

Быстрое извлечение картриджа для замены пластины. При этом, не требуется снимать державку из резцедержателя.

Makina dıřında ön ayar yapmak mümkün.

Presetting is possible outside of the machine.

Возможность предварительной настройке не в станке

Çok hassas montaj.

Ultra precise fitting.

Ультраточное соединение при сборке

Rijit sabitleme.

Rigid fixation.

Жесткая фиксация

Takım tutucu bölümü: 12x12 ve 16x16 mm.

Tool-holder section : 12x12 and 16x16 mm.

Размер секции для держателя инструмена 12x12 и 16x16мм

Saę ve sol uçlar kullanılır.

Left and right inserts available.

Используются левые и правые пластины

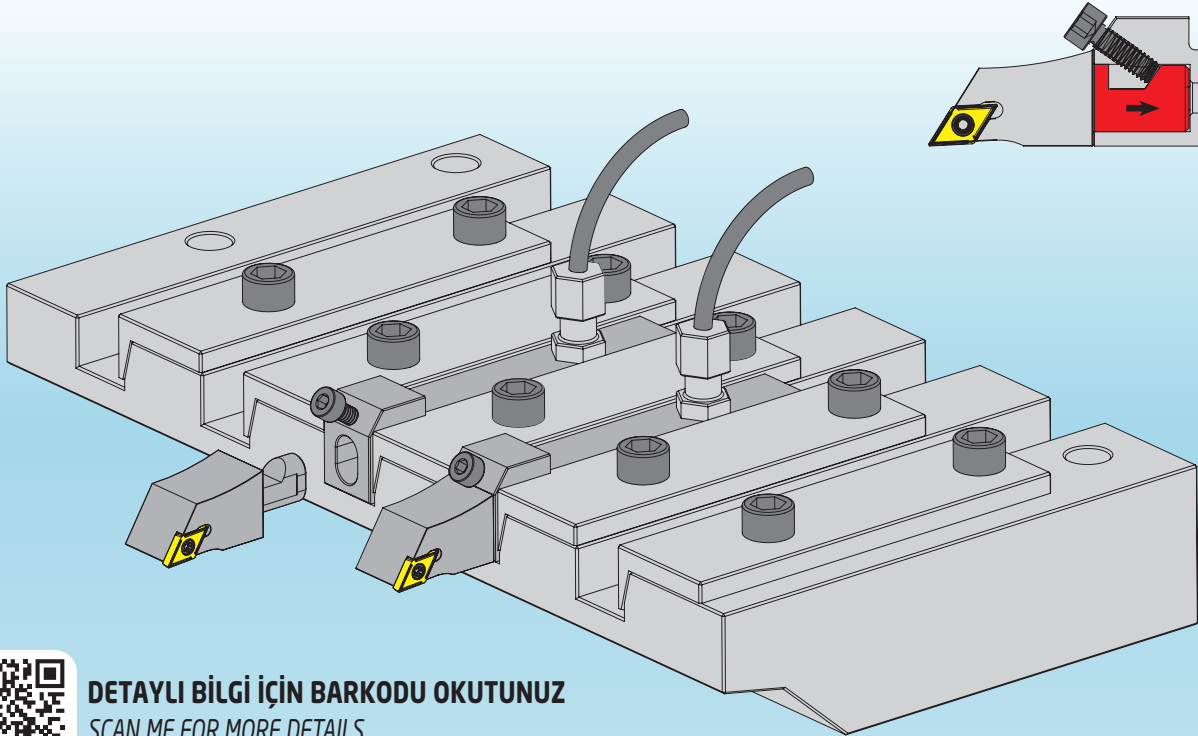

DETAYLI BİLGİ İÇİN BARKODU OKUTUNUZ

SCAN ME FOR MORE DETAILS

ПРОСКАНИРУЙТЕ ДЛЯ ПОЛУЧЕНИЯ БОЛЕЕ ПОДРОБНОЙ ИНФОРМАЦИИ

DELİK TORNA TAKIMLARI
INTERNAL TURNING TOOLHOLDERS
РАСТОЧНЫЕ ДЕРЖАВКИ



S 25 S P C L N R 12 C

1 Takım Malzemesi / Type of Boring Bar / Тип скучного бара вставки

"A" Yekpare çelik gövde soğutma suyu kanallı / "A" Solid steel with coolant hole
 "A" Расточная державка из твердой стали с подвожом СОЖ
 "E" Çelik başlıkla sert metal gövde ve soğutma suyu kanallı / "E" Carbide bar with fixed steel head and coolant hole
 "E" Расточная державка из твердосплавного карбида с подвожом СОЖ
 "C" Karbür Şaft / "C" Carbide shank / "C" Расточная державка из твердосплавного карбида
 "S" Çelik Şaft / "S" Steel shank / "S" Расточная державка из твердой стали

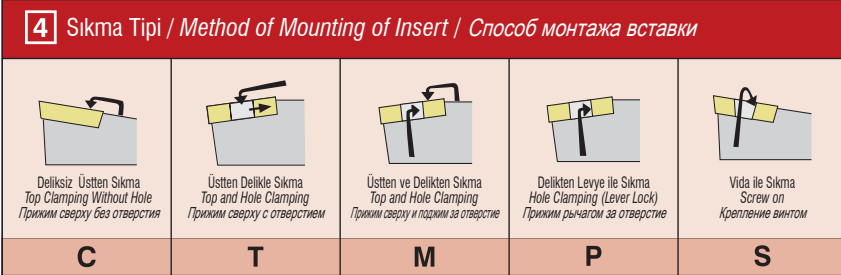
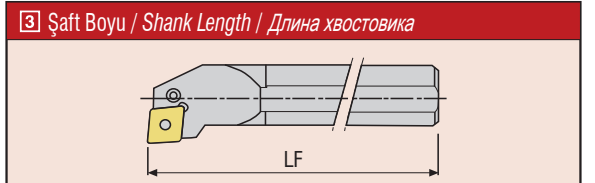

A - 32	H - 100	Q - 180	x-special
B - 40	J - 110	R - 200	
C - 50	K - 125	S - 250	
D - 60	L - 140	T - 300	
E - 70	M - 150	U - 350	
F - 80	N - 160	V - 400	
G - 90	P - 170	W - 450	

(mm)

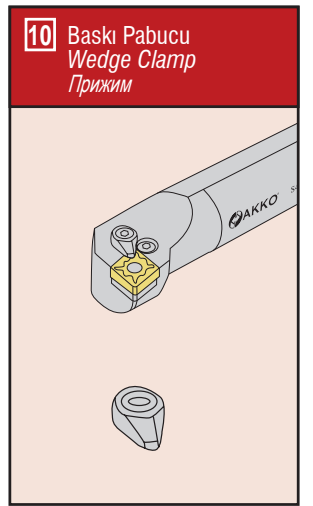
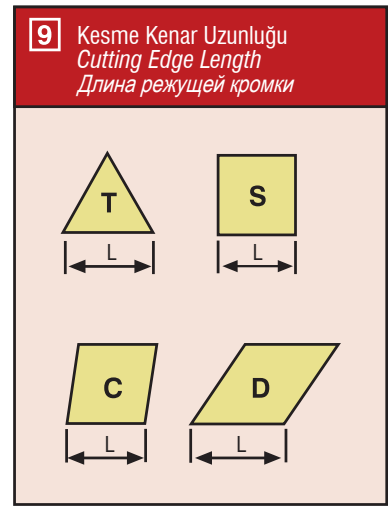
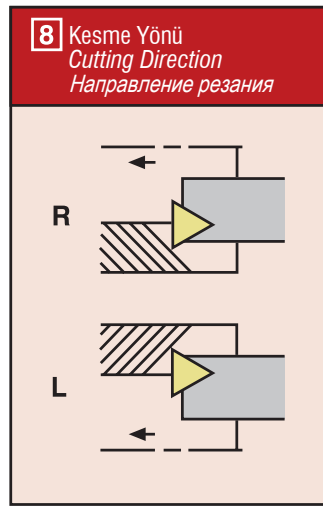
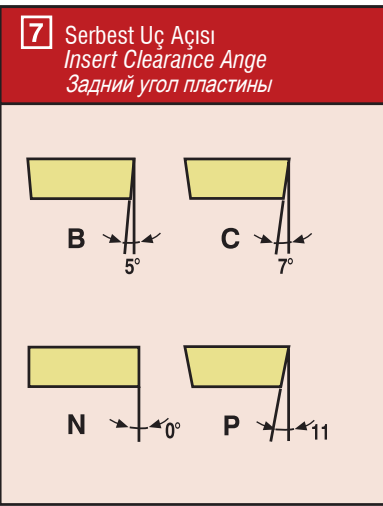
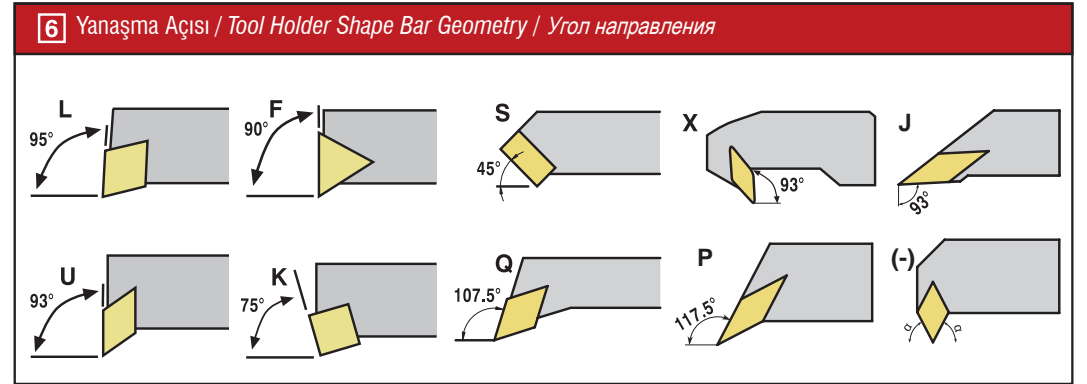
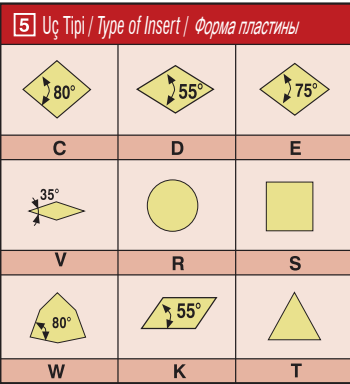



T&C-SİSTEM

T&C SİSTEM DELİK TORNA KATERLERİ
T&C SYSTEM BORING BARS
T И C-ТИП РАСТОЧНЫЕ ДЕРЖАВКИ

*konusulan
the spoken kalite...
quality...*



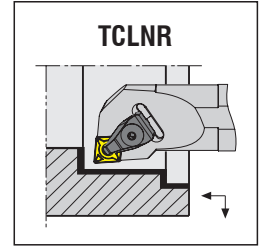
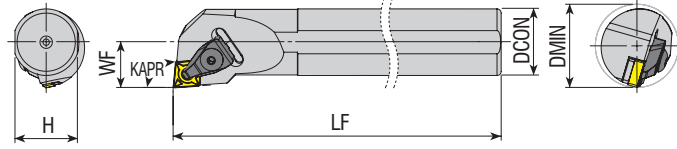

Yedek Parçaları / Spare Parts / Запасные части

Takım Kodu Ordering Code Код для заказа	Stok Stock Наличие		Takım Ölçüleri (mm) Dimension (mm) Размеры (мм)					Kesici Uç Insert Пластина	Baskı Pabucu Wedge Clamp Прижим	Pabuç Vidası Clamp Screw Зажимной винт	Altlık Shim Отпорная пластина	Altlık Vidası Shim Screw Винт отпорной пластины	Sekman Ring Кольцо	Pul Stamp Шайба	Anahtar Allen Key Ключ	
	R	L	DCON	H	LF	WF	DMIN									
S25S TCLNR/L 09	●	●	25	23	250	17	≥32	CNM. 0903..	ATK-01	AKV-01-M5x22	AACN -2-0001	AAV-09-M5x9	-			
S25S TCLNR/L 12	●	●	25	23	250	17	≥32					AAV-13-M5x8				
S32T TCLNR/L 12	●	●	32	30	300	22	≥40	CNM. 1204..	ATK-02	AKV-30-M6x22	AACN -3-0001	AAV-02-M5x12	AS-01	ABPL-01	AAL-03-3	
S40U TCLNR/L 12	●	●	40	37.5	350	27	≥50									
S50V TCLNR/L 12	●	●	50	47	400	35	≥63									
S32T TCLNR/L 16	●	●	32	30	300	22	≥40	CNM. 1606..	ATK-04	AKV-19-M7x25	AACN -3-0002	AAV-05-M6x15	AS-02	ABPL-02	AAL-05-4	
S40U TCLNR/L 16	●	●	40	37.5	350	27	≥50									
S50V TCLNR/L 16	●	●	50	47	400	35	≥63									

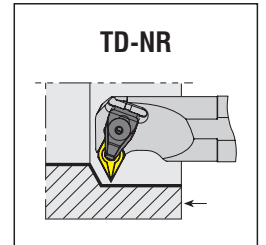
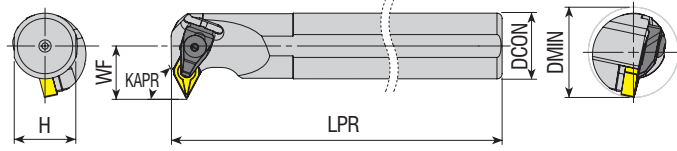

Yedek Parçaları / Spare Parts / Запасные части

Takım Kodu Ordering Code Код для заказа	Stok Stock Наличие		Takım Ölçüleri (mm) Dimension (mm) Размеры (мм)					Kesici Uç Insert Пластина	Baskı Pabucu Wedge Clamp Прижим	Pabuç Vidası Clamp Screw Зажимной винт	Altlık Shim Отпорная пластина	Altlık Vidası Shim Screw Винт отпорной пластины	Sekman Ring Кольцо	Pul Stamp Шайба	Anahtar Allen Key Ключ	
	R	L	DCON	H	LPR	WF	DMIN									
S32T TD-NR/L 15	●	●	32	30	300	26	≥44	DNM. 1506..	ATK-02	AKV-30-M6x22	AADN-3-0001	AAV-02-M5x12	AS-01	ABPL-01	AAL-03-3	
S40U TD-NR/L 15	●	●	40	37.5	350	29	≥52									
S50V TD-NR/L 15	●	●	50	47	400	35	≥63									

R: Sağ / Right / Правый L: Sol / Left / Левый
● Stokta / In Stock / В наличии ○ Stokta Yok / Non Stock Item / Нет в наличии

Sipariş Örneği/Ordering Example/Образец заказа
1 ad./pcs./шт. S25S TCLNR 09

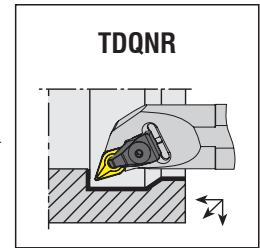
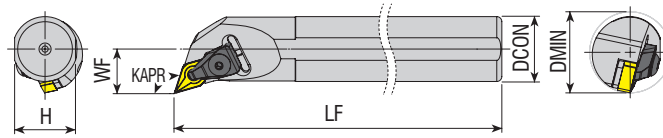

Takım Kodu Ordering Code Код для заказа	Stok Stock Наличие		Takım Ölçüleri (mm) Dimension (mm) Размеры (мм)					Kesici Uç Insert Пластина	Yedek Parçaları / Spare Parts / Запасные части						
	R	L	DCON	H	LF	WF	DMIN		Baskı Pabuçu Wedge Clamp Прижим	Pabuç Vidası Clamp Screw Зажимной винт	Altlık Shim Опорная пластина	Altlık Vidası Shim Screw Винт опорной пластины	Sekman Ring Кольцо	Pul Stamp Шайба	Anahtar Allen Key Ключ
S25S TDQNR/L 11	●	●	25	23	250	17	≥32	DNM. 1104..	ATK-01	AKV-01-M5x22	AADN-2-0001	AAV-09-M5x9	-	ABPL-01	AAL-03-3
S32T TDQNR/L 11	●	●	32	30	300	22	≥40					AAV-04-M5x12			
S25S TDQNR/L 15	●	●	25	23	250	17	≥32	DNM. 1506..	ATK-02	AKV-30-M6x22	AADN-3-0001	AAV-13-M5x8	AS-01	ABPL-01	AAL-03-3
S32T TDQNR/L 15	●	●	32	30	300	22	≥40					AAV-02-M5x12			
S40U TDQNR/L 15	●	●	40	37.5	350	27	≥50								
S50V TDQNR/L 15	●	●	50	47	400	35	≥63								

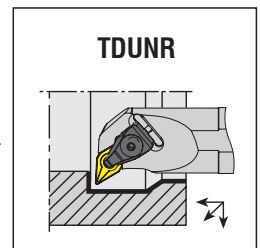
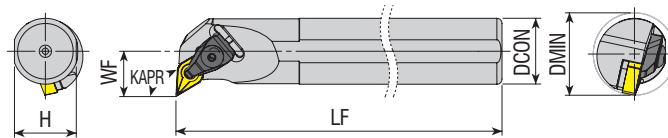

Takım Kodu Ordering Code Код для заказа	Stok Stock Наличие		Takım Ölçüleri (mm) Dimension (mm) Размеры (мм)					Kesici Uç Insert Пластина	Yedek Parçaları / Spare Parts / Запасные части						
	R	L	DCON	H	LF	WF	DMIN		Baskı Pabuçu Wedge Clamp Прижим	Pabuç Vidası Clamp Screw Зажимной винт	Altlık Shim Опорная пластина	Altlık Vidası Shim Screw Винт опорной пластины	Sekman Ring Кольцо	Pul Stamp Шайба	Anahtar Allen Key Ключ
S25S TDUNR/L 11	●	●	25	23	250	17	≥32	DNM. 1104..	ATK-01	AKV-01-M5x22	AADN-2-0001	AAV-09-M5x9	-	ABPL-01	AAL-03-3
S32T TDUNR/L 11	●	●	32	30	300	22	≥40					AAV-04-M5x12			
S25S TDUNR/L 15	●	●	25	23	250	17	≥34	DNM. 1506..	ATK-02	AKV-30-M6x22	AADN-3-0001	AAV-13-M5x8	AS-01	ABPL-01	AAL-03-3
S32T TDUNR/L 15	●	●	32	30	300	22	≥40					AAV-02-M5x12			
S40U TDUNR/L 15	●	●	40	37.5	350	27	≥50								
S50V TDUNR/L 15	●	●	50	47	400	35	≥63								

R: Sağ / Right / Правый L: Sol / Left / Левый
● Stokta / In Stock / В наличии ○ Stokta Yok / Non Stock Item / Нет в наличии

Sipariş Örneği/Ordering Example/Образец заказа
1 ad./pcs./шт. S25S TDQNR 11

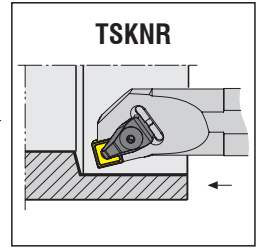
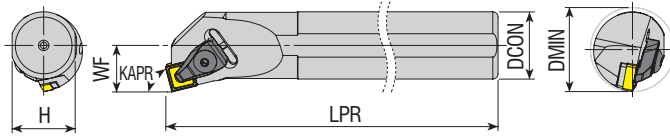

Takım Kodu Ordering Code Код для заказа	Stok Stock Наличие		Takım Ölçüleri (mm) Dimension (mm) Размеры (мм)					Kesici Uç Insert Пластина	Yedek Parçaları / Spare Parts / Запасные части						
	R	L	DCON	H	LPR	WF	DMIN		Baskı Pabucu Wedge Clamp Прижим	Pabuç Vidası Clamp Screw Зажимной винт	Altlık Shim Опорная пластина	Altlık Vidası Shim Screw Винт опорной пластины	Sekman Ring Кольцо	Pul Stamp Шайба	Anahtar Allen Key Ключ
	●	●													
S25S TSKNR/L 12	●	●	25	23	250	17	≥32	SNM. 1204..	ATK-02	AKV-30-M6x22	AASN-3-0004	AAV-13-M5x8	AS-01	ABPL-01	AAL-03-3
S32T TSKNR/L 12	●	●	32	30	300	22	≥40					AAV-02-M5x12			
S40U TSKNR/L 12	●	●	40	37.5	350	27	≥50								

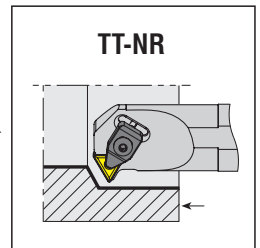
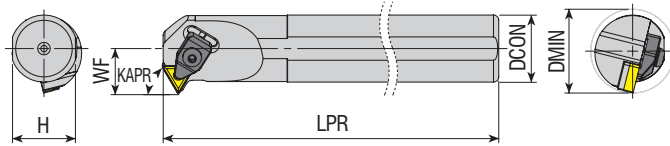
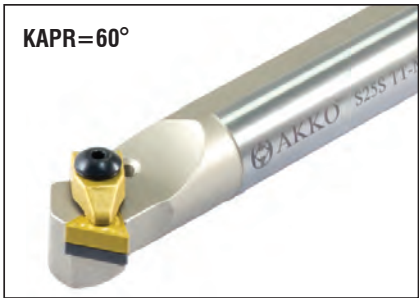

Takım Kodu Ordering Code Код для заказа	Stok Stock Наличие		Takım Ölçüleri (mm) Dimension (mm) Размеры (мм)					Kesici Uç Insert Пластина	Yedek Parçaları / Spare Parts / Запасные части						
	R	L	DCON	H	LPR	WF	DMIN		Baskı Pabucu Wedge Clamp Прижим	Pabuç Vidası Clamp Screw Зажимной винт	Altlık Shim Опорная пластина	Altlık Vidası Shim Screw Винт опорной пластины	Yay Spring Пружина	Pul Stamp Шайба	Anahtar Allen Key Ключ
	●	●													
S25S TT-NR/L 16	●	●	25	23	250	17	≥32	TNM. 1604..	ATK-01	AKV-01-M5x22	AATN-2-0002	AAV-03-M5x12	-	ABPL-01	AAL-03-3
S32T TT-NR/L 16	●	●	32	30	300	22	≥40					AAV-03-M5x12			

R: Sağ / Right / Правый L: Sol / Left / Левый
● Stokta / In Stock / В наличии ○ Stokta Yok / Non Stock Item / Нет в наличии

Sipariş Örneği/Ordering Example/Образец заказа
1 ad./pcs./шт. S25S TSKNR 12

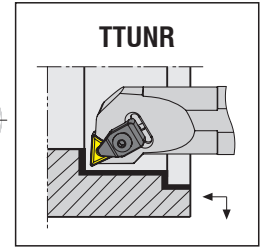
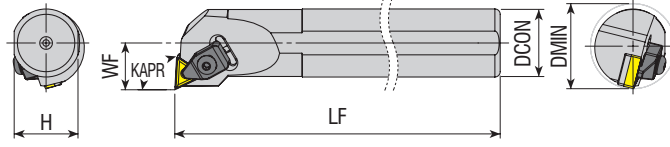
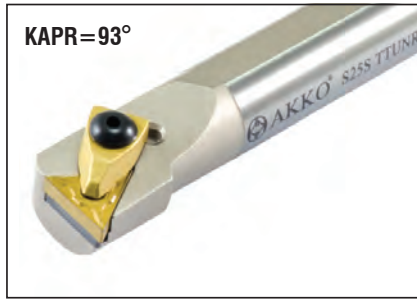

Takım Kodu Ordering Code Код для заказа	Stok Stock Наличие		Takım Ölçüleri (mm) Dimension (mm) Размеры (мм)					Kesici Uç Insert Пластина	Yedek Parçaları / Spare Parts / Запасные части						
	R	L	DCON	H	LF	WF	DMIN		Baskı Pabuçu Wedge Clamp Прижим	Pabuç Vidası Clamp Screw Зажимной винт	Altlık Shim Опорная пластина	Altlık Vidası Shim Screw Винт опорной пластины	Sekman Ring Кольцо	Pul Stamp Шайба	Anahtar Allen Key Ключ
S25S TTUNR/L 16	●	●	25	23	250	17	≥32	TNM. 1604..	ATK-01	AKV-01-M5x22	AATN-2-0002	AAV-03-M5x12	-	ABPL-01	AAL-03-3
S32T TTUNR/L 16	●	●	32	30	300	22	≥40								
S25S TTUNR/L 22	●	●	25	23	250	17	≥32	TNM. 2204..	ATK-02	AKV-30-M6x22	AATN-3-0015	AAV-02-M5x12	AS-01	ABPL-01	AAL-03-3
S32T TTUNR/L 22	●	●	32	30	300	22	≥40								
S40U TTUNR/L 22	●	●	40	37.5	350	27	≥50								
S50V TTUNR/L 22	●	●	50	47	400	35	≥63								

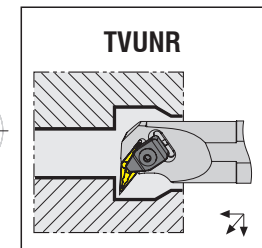
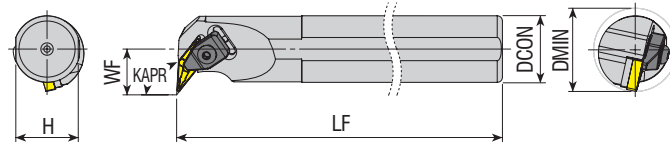
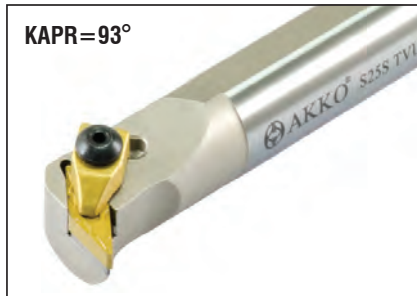

Takım Kodu Ordering Code Код для заказа	Stok Stock Наличие		Takım Ölçüleri (mm) Dimension (mm) Размеры (мм)					Kesici Uç Insert Пластина	Yedek Parçaları / Spare Parts / Запасные части						
	R	L	DCON	H	LF	WF	DMIN		Baskı Pabuçu Wedge Clamp Прижим	Pabuç Vidası Clamp Screw Зажимной винт	Altlık Shim Опорная пластина	Altlık Vidası Shim Screw Винт опорной пластины	Yay Spring Пружина	Pul Stamp Шайба	Anahtar Allen Key Ключ
S25S TVUNR/L 16	●	●	25	23	250	20	≥36	VNM. 1604..	ATK-01	AKV-01-M5x22	AAVN-2-0002	AAV-04-M5x12	-	ABPL-01	AAL-03-3
S32T TVUNR/L 16	●	●	32	30	300	22	≥40								
S40U TVUNR/L 16	●	●	40	37.5	350	27	≥50								

R: Sağ / Right / Правый L: Sol / Left / Левый
● Stokta / In Stock / В наличии ○ Stokta Yok / Non Stock Item / Нет в наличии

Sipariş Örneği/Ordering Example/Образец заказа
1 ad./pcs./шт. S25S TTUNR 16

T-SİSTEM DELİK TORNA KATERLERİ
T-SYSTEM BORING BARS
T-ТИП РАСТОЧНЫЕ ДЕРЖАВКИ

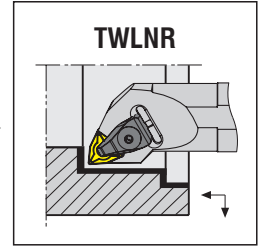
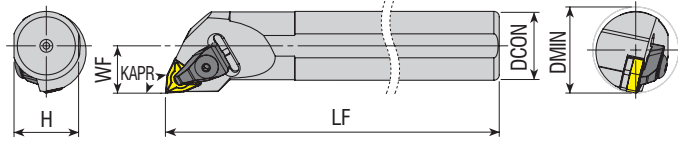

Yedek Parçaları / Spare Parts / Запасные части

Takım Kodu Ordering Code Код для заказа	Stok Stock Наличие		Takım Ölçüleri (mm) Dimension (mm) Размеры (мм)					Kesici Uç Insert Пластина	Baskı Pabuçu Wedge Clamp Прижим	Pabuç Vidası Clamp Screw Зажимной винт	Altlık Shim Опорная пластина	Altlık Vidası Shim Screw Винт опорной пластины	Sekman Ring Кольцо	Pul Stamp Шайба	Anahtar Allen Key Ключ
	R	L	DCON	H	LF	WF	DMIN								
S25S TWLNR/L 06	●	●	25	23	250	17	≥32	WNM. 0604..	ATK-01	AKV-01-M5x22	AAWN-SW317	AAV-01-M3x10	-		
S32T TWLNR/L 06	●	●	32	30	300	22	≥40								
S25S TWLNR/L 08	●	●	25	23	250	17	≥32								
S32T TWLNR/L 08	●	●	32	30	300	22	≥40								
S40U TWLNR/L 08	●	●	40	37.5	350	27	≥50								
S50V TWLNR/L 08	●	●	50	47	400	35	≥63								
A40T TWLNR/L 08	●	○	40	37.5	300	27	≥50	WNM. 0804..	ATK-02	AKV-30-M6x22	AAWN-3-0001	AAV-13-M5x8	AS-01	ABPL-01	AAL-03-3
A50U TWLNR/L 08	●	○	50	47	350	35	≥63								

C-SİSTEM DELİK TORNA KATERLERİ
C-SYSTEM BORING BARS
C-ТИП РАСТОЧНЫЕ ДЕРЖАВКИ

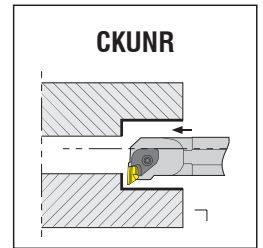
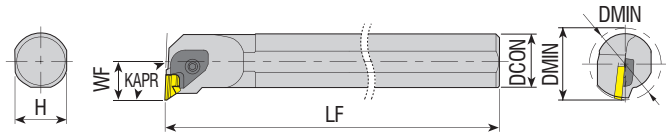

Yedek Parçaları / Spare Parts / Запасные части

Takım Kodu Ordering Code Код для заказа	Stok Stock Наличие		Takım Ölçüleri (mm) Dimension (mm) Размеры (мм)					Kesici Uç Insert Пластина	Baskı Pabuçu Wedge Clamp Прижим	Pabuç Vidası Clamp Screw Зажимной винт	Altlık Shim Опорная пластина	Altlık Vidası Shim Screw Винт опорной пластины	Yay Spring Пружина	Pul Stamp Шайба	Anahtar Allen Key Ключ
	R	L	DCON	H	LF	WF	DMIN								
S25S CKUNR/L 16	●	●	25	23	250	19	≥38	KNUX 1604..	ACK-01-R ACK-02-L	AKV-06-M6x20	AKS-16-R AKS-16-L	AAV-01-M3x10	AKY-02	ABPL-01	AAL-05-4
S32T CKUNR/L 16	●	●	32	30	300	22	≥40								
S40U CKUNR/L 16	●	●	40	37.5	350	27	≥50								
S50V CKUNR/L 16	●	●	50	47	400	35	≥63								

R: Sağ / Right / Правый L: Sol / Left / Левый
 ● Stokta / In Stock / В наличии ○ Stokta Yok / Non Stock Item / Нет в наличии

Sipariş Örneği/Ordering Example/Образец заказа
 1 ad./pcs./шт. S25S TWLNR 06



M-SİSTEM

M-SİSTEM DELİK TORNA KATERLERİ
M-SYSTEM BORING BARS
M-ТИП РАСТОЧНЫЕ ДЕРЖАВКИ

*konusulan
the spoken kalite...
quality...*



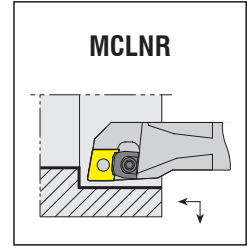
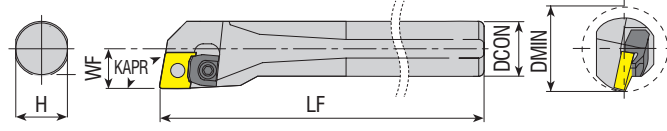

Takım Kodu Ordering Code Код для заказа	Stok Stock Наличие		Takım Ölçüleri (mm) Dimension (mm) Размеры (мм)					Kesici Uç Insert Пластина	Yedek Parçaları / Spare Parts / Запасные части					
	R	L	DCON	H	LF	WF	DMIN		Baskı Pabucu Wedge Clamp Прижим	Pabuç Vidası Clamp Screw Зажимной винт	Altlık Shim Опорная пластина	Pim Pin Штифт	Pul Stamp Шайба	Anahtar Allen Key Ключ
S20R MCLNR/L 12	●	●	20	18.3	200	13	≥25	CNM. 1204..	AMK-07	AKV-04-M5x17	AACN-3-0001	APM-12	-	AAL-03-3
S25S MCLNR/L 12	●	●	25	23	250	17	≥32		AMK-03			APM-13		
S32T MCLNR/L 12	●	●	32	30	300	22	≥40					APM-04		

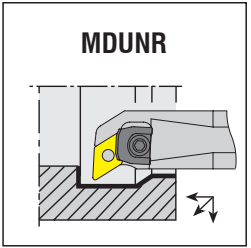
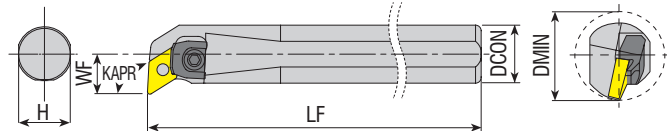

Takım Kodu Ordering Code Код для заказа	Stok Stock Наличие		Takım Ölçüleri (mm) Dimension (mm) Размеры (мм)					Kesici Uç Insert Пластина	Yedek Parçaları / Spare Parts / Запасные части					
	R	L	DCON	H	LF	WF	DMIN		Baskı Pabucu Wedge Clamp Прижим	Pabuç Vidası Clamp Screw Зажимной винт	Altlık Shim Опорная пластина	Pim Pin Штифт	Sekman Ring Кольцо	Pul Stamp Шайба
S20R MDUNR/L 11	●	●	20	18.3	200	13	≥25	DNM. 1104..	AMK-03	AKV-17-M5x15	AACN-3-0001	APM-03	-	ABPL-01
S25S MDUNR/L 11	●	●	25	23	250	17	≥32			AKV-04-M5x17				
S32T MDUNR/L 11	○	○	32	30	300	22	≥40							
S25S MDUNR/L 15	●	●	25	23	250	17	≥32	DNM. 1506..	AMK-04	AKV-20-M6x19	AACN-3-0001		AS-01	ABPL-01
S32T MDUNR/L 15	●	●	32	30	300	22	≥40			AKV-30-M6x22				
S40U MDUNR/L 15	●	●	40	37.5	350	27	≥50							
S50V MDUNR/L 15	●	●	50	47	400	35	≥63							

R: Sağ / Right / Правый L: Sol / Left / Левый
● Stokta / In Stock / В наличии ○ Stokta Yok / Non Stock Item / Нет в наличии

Sipariş Örneği/Ordering Example/Образец заказа
1 ad./pcs./шт. S20R MCLNR 12

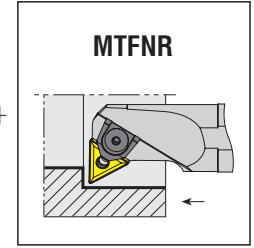
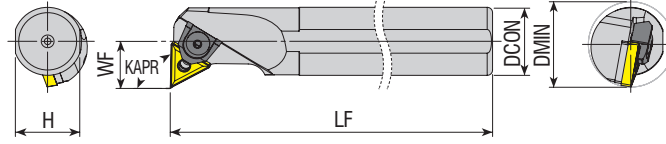

Takım Kodu Ordering Code Код для заказа	Stok Stock Наличие		Takım Ölçüleri (mm) Dimension (mm) Размеры (мм)				Kesici Uç Insert Пластина	Baskı Pabucu Wedge Clamp Прижим	Pabuç Vidası Clamp Screw Зажимной винт	Altlık Shim Опорная пластина	Pim Pin Штифт	Sekman Ring Кольцо	Pul Stamp Шайба	Anahtar Allen Key Ключ	
	R	L	DCON	H	LF	WF									DMIN
S20R MTFNR/L 16	●	●	20	18.3	200	14	≥25	TNM. 1604..	AMK-02	AKV-17-M5x15	-	APM-03	-	-	AAL-03-3
S25S MTFNR/L 16	●	●	25	23	250	17	≥32		AMK-04	AKV-30-M6x22	AATN-2-0002	APM-14	AS-01	ABPL-01	
S32T MTFNR/L 16	●	●	32	30	300	22	≥40				AATN-3-0015	APM-01			
S40U MTFNR/L 16	●	●	40	37.5	350	27	≥50		APM-02						
S32T MTFNR/L 22	●	●	32	30	300	22	≥40	TNM. 2204..	AMK-04	AKV-30-M6x22	AATN-3-0015	APM-02	ABPL-01	AAL-03-3	
S40U MTFNR/L 22	●	●	40	37.5	350	27	≥50								
S50V MTFNR/L 22	●	○	50	47	400	35	≥63								

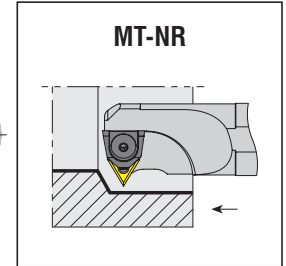
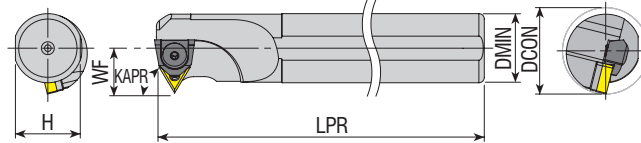

Takım Kodu Ordering Code Код для заказа	Stok Stock Наличие		Takım Ölçüleri (mm) Dimension (mm) Размеры (мм)				Kesici Uç Insert Пластина	Baskı Pabucu Wedge Clamp Прижим	Pabuç Vidası Clamp Screw Зажимной винт	Altlık Shim Опорная пластина	Pim Pin Штифт	Sekman Ring Кольцо	Pul Stamp Шайба	Anahtar Allen Key Ключ	
	R	L	DCON	H	LPR	WF									DMIN
S20R MT-NR/L 16	●	●	20	18.3	200	16	≥26	TNM. 1604..	AMK-02	AKV-04-M5x17	-	APM-03	-	-	AAL-03-3
S25S MT-NR/L 16	●	●	25	23	250	17	≥32				AATN-2-0002	APM-14	AS-01	ABPL-01	
S32T MT-NR/L 16	●	●	32	30	300	22	≥40					AATN-3-0015			
S40U MT-NR/L 16	●	●	40	37.5	350	27	≥50				APM-02				
S32T MT-NR/L 22	●	●	32	30	300	24	≥40	TNM. 2204..	AMK-04	AKV-30-M6x22	AATN-3-0015	APM-02	ABPL-01	AAL-03-3	
S40U MT-NR/L 22	●	●	40	37.5	350	27	≥50								
S50U MT-NR/L 22	●	●	50	47	350	35	≥63								

R: Sağ / Right / Правый L: Sol / Left / Левый

● Stokta / In Stock / В наличии ○ Stokta Yok / Non Stock Item / Нет в наличии

Sipariş Örneği/Ordering Example/Образец заказа

1 ad./pcs./шт. S20R MTFNR 16

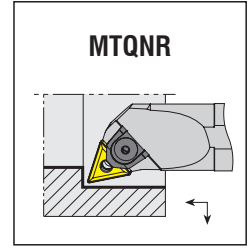
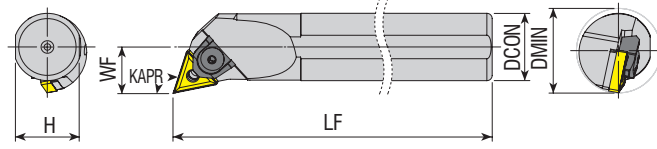

Takım Kodu Ordering Code Код для заказа	Stok / Stock / Наличие							Kesici Uç / Insert / Пластина	Yedek Parçaları / Spare Parts / Запасные части						
	R	L	DCON	H	LF	WF	DMIN		Baskı Pabucu / Wedge Clamp / Прижим	Pabuç Vidası / Clamp Screw / Зажимной винт	Altlık / Shim / Опорная пластина	Pim / Pin / Штифт	Sekman / Ring / Кольцо	Pul / Stamp / Шайба	Anahtar / Allen Key / Ключ
S20R MTQNR/L 16	●	●	20	18.3	200	13	≥25	TNN. 1604..	AMK-02	AKV-17-M5x15	-	APM-11	-	-	-
S25S MTQNR/L 16	●	●	25	23	250	17	≥32				AATN-2-0002	APM-14			
S32T MTQNR/L 16	●	●	32	30	300	22	≥40					APM-01			
S40U MTQNR/L 16	●	●	40	37.5	350	27	≥50	TNN. 2204..	AMK-04	AKV-30-M6x22			AS-01	ABPL-01	AAL-03-3
S32T MTQNR/L 22	●	●	32	30	300	22	≥40				AATN-3-0015	APM-02			
S40U MTQNR/L 22	●	●	40	37.5	350	27	≥50								
S50V MTQNR/L 22	●	●	50	47	400	35	≥63								

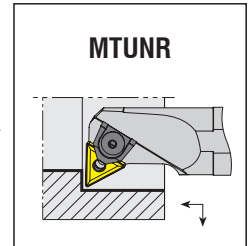
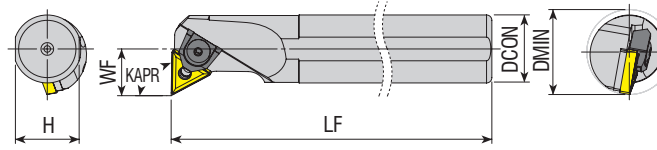

Takım Kodu Ordering Code Код для заказа	Stok / Stock / Наличие							Kesici Uç / Insert / Пластина	Yedek Parçaları / Spare Parts / Запасные части						
	R	L	DCON	H	LF	WF	DMIN		Baskı Pabucu / Wedge Clamp / Прижим	Pabuç Vidası / Clamp Screw / Зажимной винт	Altlık / Shim / Опорная пластина	Pim / Pin / Штифт	Sekman / Ring / Кольцо	Pul / Stamp / Шайба	Anahtar / Allen Key / Ключ
S20R MTUNR/L 16	●	●	20	18.3	200	13	≥25	TNN. 1604..	AMK-02	AKV-17-M5x15	-	APM-03	-	-	-
S25S MTUNR/L 16	●	●	25	23	250	17	≥32				AATN-2-0002	APM-14			
S32T MTUNR/L 16	●	●	32	30	300	22	≥40					APM-01			
S40U MTUNR/L 16	●	●	40	37.5	350	27	≥50	TNN. 2204..	AMK-04	AKV-30-M6x22			AS-01	ABPL-01	AAL-03-3
S50V MTUNR/L 16	●	●	50	47	400	35	≥63				AATN-3-0015	APM-02			
S32T MTUNR/L 22	●	●	32	30	300	22	≥40								
S40U MTUNR/L 22	●	●	40	37.5	350	27	≥50								
S50V MTUNR/L 22	●	●	50	47	400	35	≥63								

R: Sağ / Right / Правый L: Sol / Left / Левый
● Stokta / In Stock / В наличии ○ Stokta Yok / Non Stock Item / Нет в наличии

Sipariş Örneği/Ordering Example/Образец заказа
1 ad./pcs./шт. S20R MTQNR 16

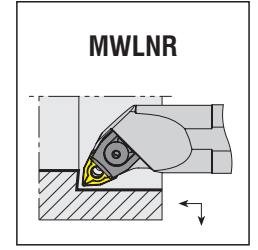
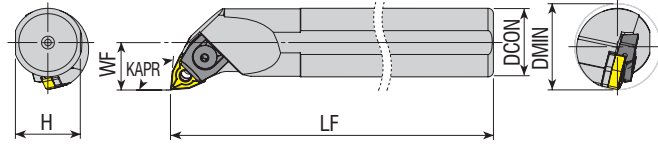

Takım Kodu Ordering Code Код для заказа	Stok Stock Наличие		Takım Ölçüleri (mm) Dimension (mm) Размеры (мм)				Kesici Uç Insert Пластина	Baskı Pabuçu Wedge Clamp Прижим	Pabuç Vidası Clamp Screw Зажимной винт	Altlık Shim Отверная пластина	Pim Pin Штифт	Sekman Ring Кольцо	Pul Stamp Шайба	Anahtar Allen Key Ключ	
	R	L	DCON	H	LF	WF									DMIN
S16P MWLNR/L 06	●	●	16	14.8	170	11	≥20	WNM. 0604..	AMK-01	AKV-17-M5x15	-	APM-09	-	-	AAL-03-3
S20R MWLNR/L 06	●	●	20	18.3	200	13	≥25			AKV-04-M5x17		APM-10			
S25S MWLNR/L 06	●	●	25	23	250	17	≥32			AKV-27-M6x20		APM-08			
S25S MWLNR/L 08	●	●	25	23	250	17	≥32	WNM. 0804..	AMK-05	AKV-03-M6x22	AAWN-3-0001	APM-04	AS-01	ABPL-01	
S32T MWLNR/L 08	●	●	32	30	300	22	≥40			APM-02					
S40U MWLNR/L 08	●	●	40	37.5	350	27	≥50								

R: Sağ / Right / Правый L: Sol / Left / Левый
● Stokta / In Stock / В наличии ○ Stokta Yok / Non Stock Item / Нет в наличии

Sipariş Örneği/Ordering Example/Образец заказа
1 ad./pcs./шт. S16P MWLNR 06





*konusulan
the spoken kalite...
quality...*

P-SİSTEM

P-SİSTEM DELİK TORNA KATERLERİ
P-SYSTEM BORING BARS
P-ТИП РАСТОЧНЫЕ ДЕРЖАВКИ



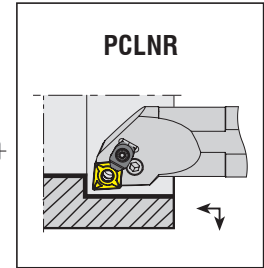
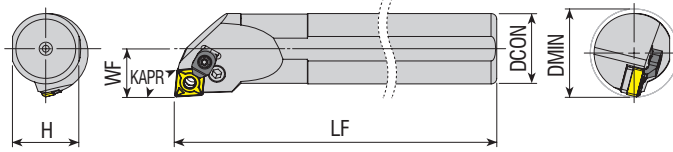

Takım Kodu Ordering Code Код для заказа	Stok Stock Наличие		Takım Ölçüleri (mm) Dimension (mm) Размеры (мм)					Kesici Uç Insert Пластина	Yedek Parçaları / Spare Parts / Запасные части						
	R	L	DCON	H	LF	WF	DMIN		Levye Lever Рычаг	Levye Vidası Lever Screw Винт рычага	Altlık Shim Опорная пластина	Altlık Yayı Shim Spring Втулка рычага	Baskı Pabuçu Wedge Clamp Прижим	Pabuç Vidası Clamp Screw Зажимной винт	Anahtar Allen Key Ключ
S16P PCLNR/L 09	●	●	16	14.8	170	11	≥20	CNM. 0903..	APL-07	ALV-07-M6x13	-	AAV-07	-	-	AAL-02-2.5
S20R PCLNR/L 09	●	●	20	18.3	200	13	≥25		APL-01	ALV-02-M6x17	AACN-2-0002	AAV-01	-	-	AAL-02-2.5
S25S PCLNR/L 09	●	○	25	23	250	17	≥32								
S25S PCLNR/L 12C	●	●	25	23	250	17	≥32	CNM. 1204..		ALV-08-M8x16					
S32T PCLNR/L 12C	●	●	32	30	300	22	≥40		APL-02	ALV-03-M8x19	AACN-3-0001	AAV-02	ACK-05	4015-M4x11	AAL-03-3
S40U PCLNR/L 12C	●	●	40	37.5	350	27	≥50								
S50V PCLNR/L 12C	●	●	50	47	400	35	≥63	CNM. 1606..							
S32T PCLNR/L 16C	●	●	32	30	300	22	≥40		APL-04	ALV-04-M8x22	AACN-3-0002	AAV-03	ACK-09	AAV-05-M6x15	
S40U PCLNR/L 16C	●	●	40	37.5	350	27	≥50								
S50V PCLNR/L 16C	●	●	50	47	400	35	≥63	CNM. 1906..							
S40U PCLNR/L 19C	●	●	40	37.5	350	27	≥50		APL-05	ALV-05-M10x27	AACN-3-0003	AAV-04	ACK-09	AAV-05-M6x15	AAL-05-4
S50V PCLNR/L 19C	●	●	50	47	400	35	≥63								
A20P PCLNR/L 09	●	●	20	18.3	170	13	≥25	CNM. 0903..	APL-01	ALV-02-M6x17	AACN-2-0002	AAV-01	-	-	AAL-02-2.5
A25R PCLNR/L 12C	●	●	25	23	200	17	≥32			ALV-08-M8x16					
A32S PCLNR/L 12C	●	●	32	30	250	22	≥40		APL-02	ALV-03-M8x19	AACN-3-0001	AAV-02	ACK-05	4015-M4x11	AAL-03-3
A40T PCLNR/L 12C	●	●	40	37.5	300	27	≥50	CNM. 1204..							
A50U PCLNR/L 12C	●	●	50	47	350	35	≥63								
A32S PCLNR/L 16C	●	●	32	30	250	22	≥40		APL-04	ALV-04-M8x22	AACN-3-0002	AAV-03	ACK-09	AAV-05-M6x15	
A40T PCLNR/L 16C	●	●	40	37.5	300	27	≥50	CNM. 1606..							
A50U PCLNR/L 16C	●	●	50	47	350	35	≥63		APL-05	ALV-05-M10x27	AACN-3-0003	AAV-04	ACK-09	AAV-05-M6x15	AAL-05-4
A40T PCLNR/L 19C	●	●	40	37.5	300	27	≥50								
A50U PCLNR/L 19C	●	●	50	47	350	35	≥63	CNM. 1906..							
A40T PCLNR/L 19C	●	●	40	37.5	300	27	≥50		APL-05	ALV-05-M10x27	AACN-3-0003	AAV-04	ACK-09	AAV-05-M6x15	AAL-05-4
A50U PCLNR/L 19C	●	●	50	47	350	35	≥63								

R: Sağ / Right / Правый L: Sol / Left / Левый

● Stokta / In Stock / В наличии ○ Stokta Yok / Non Stock Item / Нет в наличии

Sipariş Örneği/Ordering Example/Образец заказа

1 ad./pcs./шт. S16P PCLNR 09

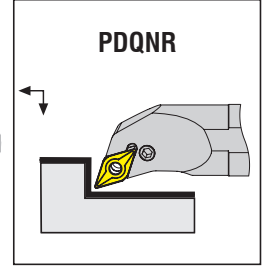
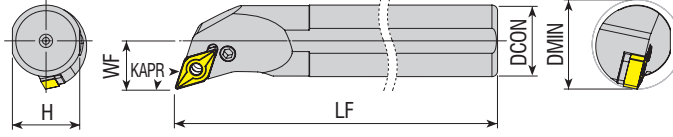

Takım Kodu Ordering Code Код для заказа	Stok Stock Наличие		Takım Ölçüleri (mm) Dimension (mm) Размеры (мм)					Kesici Uç Insert Пластина	Yedek Parçaları / Spare Parts / Запасные части						
	R	L	DCON	H	LF	WF	DMIN		Levyeye Lever Рычаг	Levyeye Vidası Lever Screw Винт рычага	Altılık Shim Опорная пластина	Altılık Yayı Shim Spring Втулка рычага	Baskı Pabuçu Wedge Clamp Прижим	Pabuç Vidası Clamp Screw Зажимной винт	Anahtar Allen Key Ключ
	●	○													
S20R PDQNR/L 11	●	○	20	18.3	200	13	≥25	DNM. 1104..	APL-01	ALV-01-M6x14 ALV-02-M6x17	AADN-SD317	AAY-01			AAL-02-2.5
S25S PDQNR/L 11	●	●	25	23	250	17	≥32								
S32T PDQNR/L 15	●	●	32	30	300	22	≥40	DNM. 1506..	APL-03	ALV-03-M8x19	AADN-3-0001	AAY-02	-	-	AAL-03-3
S40U PDQNR/L 15	●	●	40	37.5	350	27	≥50								
S50V PDQNR/L 15	●	●	50	47	400	35	≥63	DNM. 1504..	APL-03	ALV-03-M8x19	AADN-2-0003	AAY-02	-	-	AAL-03-3
S32T PDQNR/L 1504	●	●	32	30	300	22	≥40								
S40U PDQNR/L 1504	●	●	40	37.5	350	27	≥50	DNM. 1104..	APL-01	ALV-01-M6x14 ALV-02-M6x17	AADN-SD317	AAY-01	-	-	AAL-02-2.5
S50V PDQNR/L 1504	●	●	50	47	400	35	≥63								
A20P PDQNR/L 11	●	●	20	18.3	170	13	≥25	DNM. 1506..	APL-03	ALV-03-M8x19	AADN-3-0001	AAY-02	-	-	AAL-03-3
A25R PDQNR/L 11	●	●	25	23	200	17	≥32								
A32S PDQNR/L 15	●	●	32	30	250	22	≥40	DNM. 1504..	APL-03	ALV-03-M8x19	AADN-2-0003	AAY-02	-	-	AAL-03-3
A40T PDQNR/L 15	●	●	40	37.5	300	27	≥50								
A50U PDQNR/L 15	●	●	50	47	350	35	≥63	DNM. 1506..	APL-03	ALV-03-M8x19	AADN-3-0001	AAY-02	-	-	AAL-03-3
A32S PDQNR/L 1504	●	●	32	30	250	22	≥40								
A40T PDQNR/L 1504	●	●	40	37.5	300	27	≥50								

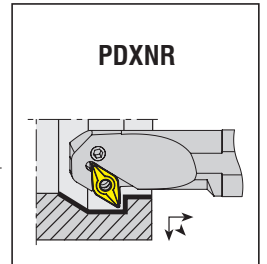
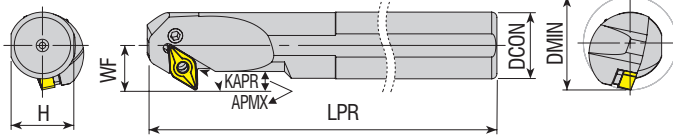

Takım Kodu Ordering Code Код для заказа	Stok Stock Наличие		Takım Ölçüleri (mm) Dimension (mm) Размеры (мм)					Kesici Uç Insert Пластина	Yedek Parçaları / Spare Parts / Запасные части							
	R	L	DCON	H	LPR	WF	APMX		DMIN	Levyeye Lever Рычаг	Levyeye Vidası Lever Screw Винт рычага	Altılık Shim Опорная пластина	Altılık Yayı Shim Spring Втулка рычага	Baskı Pabuçu Wedge Clamp Прижим	Pabuç Vidası Clamp Screw Зажимной винт	Anahtar Allen Key Ключ
	●	○														
S32T PDXNR/L 15	●	●	32	30	300	22	12	≥45	DNM. 1506..	APL-03	ALV-08-M8x16 ALV-03-M8x19 ALV-08-M8x16 ALV-03-M8x19	AADN-3-0001	AAY-02	-	-	AAL-03-3
S40U PDXNR/L 15	●	●	40	37.5	350	27	14	≥50								
S50V PDXNR/L 15	●	●	50	47	400	35	19	≥63								
A32S PDXNR/L 15	●	●	32	30	250	22	12	≥40								
A40T PDXNR/L 15	●	●	40	37.5	300	27	14	≥50								
A50U PDXNR/L 15	●	●	50	47	350	35	19	≥63								

R: Sağ / Right / Правый L: Sol / Left / Левый

● Stokta / In Stock / В наличии ○ Stokta Yok / Non Stock Item / Нет в наличии

Not: "APMX" ölçüleri R0.8'e göre verilmiştir. Note: Dimensions of "APMX" are given according to R.08. Примечание: размеры должны быть R.08

Sipariş Örneği/Ordering Example/Образец заказа

1 ad./pcs./шт. S20R PDQNR 11

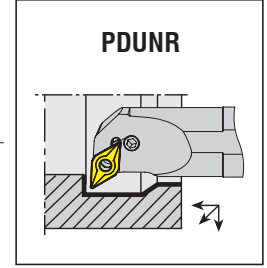
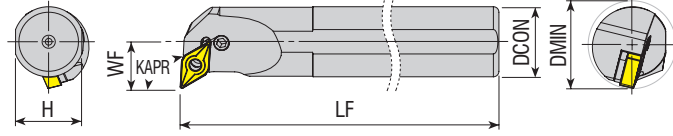

Takım Kodu Ordering Code Код для заказа	Stok Stock Наличие		Takım Ölçüleri (mm) Dimension (mm) Размеры (мм)					Kesici Uç Insert Пластина	Yedek Parçaları / Spare Parts / Запасные части						
	R	L	DCON	H	LF	WF	DMIN		Leyve Lever Рычаг	Leyve Vidası Lever Screw Винт рычага	Altlık Shim Опорная пластина	Altlık Yay Shim Spring Втулка рычага	Baskı Pabuç Wedge Clamp Прижим	Pabuç Vidası Clamp Screw Зажимной винт	Anahtar Allen Key Ключ
	●	○													
S20R PDUNR/L 11	●	●	20	18.3	200	13	≥25	DNM. 1104..	APL-01	ALV-01-M6x14 ALV-02-M6x17 ALV-08-M8x16	AADN-SD317	AAY-01	-	-	AAL-02-2.5
S25S PDUNR/L 11	●	●	25	23	250	17	≥32								
S25S PDUNR/L 15	●	●	25	23	250	19	≥32								
S32T PDUNR/L 15	●	●	32	30	300	22	≥40	DNM. 1506..	APL-03	ALV-03-M8x19	AADN-3-0001	AAY-02	-	-	AAL-03-3
S40U PDUNR/L 15	●	●	40	37.5	350	27	≥50								
S50V PDUNR/L 15	●	●	50	47	400	35	≥63								
A20P PDUNR/L 11	●	●	20	18.3	170	13	≥25	DNM. 1104..	APL-01	ALV-01-M6x14 ALV-02-M6x17	AADN-SD317	AAY-01	-	-	AAL-02-2.5
A25R PDUNR/L 11	●	●	25	23	200	17	≥32								
A32S PDUNR/L 11	●	●	32	30	250	22	≥40								
A32S PDUNR/L 15	●	●	32	30	250	22	≥40	DNM. 1506..	APL-03	ALV-03-M8x19	AADN-3-0001	AAY-02	-	-	AAL-03-3
A40T PDUNR/L 15	●	●	40	37.5	300	27	≥50								
A50U PDUNR/L 15	●	●	50	47	350	35	≥63								

R: Sağ / Right / Правый L: Sol / Left / Левый

● Stokta / In Stock / В наличии ○ Stokta Yok / Non Stock Item / Нет в наличии

Sipariş Örneği/Ordering Example/Образец заказа
1 ad./pcs./шт. S20R PDUNR 11



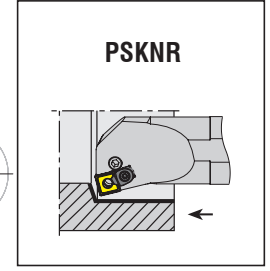
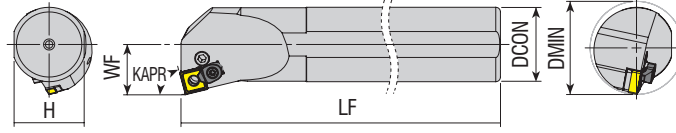

Takım Kodu Ordering Code Код для заказа	Stok Stock Наличие		Takım Ölçüleri (mm) Dimension (mm) Размеры (мм)					Kesici Uç Insert Пластина	Yedek Parçaları / Spare Parts / Запасные части						
	R	L	DCON	H	LF	WF	DMIN		Levyeye Lever Рычаг	Levyeye Vidası Lever Screw Винт рычага	Altılık Shim Опорная пластина	Altılık Yayısı Shim Spring Втулка рычага	Baskı Pabuçu Wedge Clamp Прижим	Pabuç Vidası Clamp Screw Зажимной винт	Anahtar Allen Key Ключ
S25S PSKNR/L 12C	●	●	25	23	250	17	≥32	SNM. 1204..	APL-02	ALV-03-M8x19	AASN-3-0004	AAY-02	ACK-05	4015-M4x11	AAL-03-3
S32T PSKNR/L 12C	●	●	32	30	300	22	≥40								
S40U PSKNR/L 12C	●	●	40	37.5	350	27	≥50								
S50V PSKNR/L 12C	●	●	50	47	400	35	≥63								
S32T PSKNR/L 15C	○	○	32	30	300	22	≥40	SNM. 1506..	APL-04	ALV-04-M8x22	AASN-3-0023	AAY-03	ACK-09	AAV-05-M6x15	
S40U PSKNR/L 15C	○	●	40	37.5	350	27	≥50								
S50V PSKNR/L 15C	○	○	50	47	400	35	≥63								
A25R PSKNR/L 12C	●	●	25	23	200	17	≥32	SNM. 1204..	APL-02	ALV-03-M8x19	AASN-3-0004	AAY-02	ACK-05	4015-M4x11	
A32S PSKNR/L 12C	●	●	32	30	250	22	≥40								
A40T PSKNR/L 12C	●	●	40	37.5	300	27	≥50								
A50U PSKNR/L 12C	○	●	50	47	350	35	≥63								
A32S PSKNR/L 15C	●	●	32	30	250	22	≥40	SNM. 1506..	APL-04	ALV-04-M8x22	AASN-3-0023	AAY-03	ACK-09	AAV-05-M6x15	
A40T PSKNR/L 15C	●	●	40	37.5	300	27	≥50								
A50U PSKNR/L 15C	●	●	50	47	350	35	≥63								

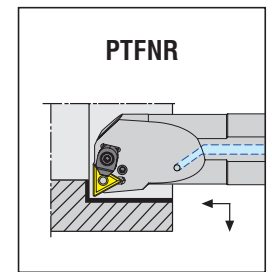
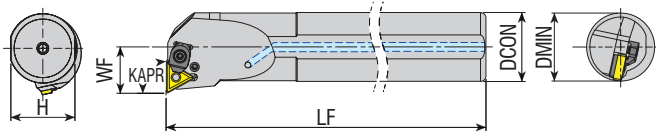

Takım Kodu Ordering Code Код для заказа	Stok Stock Наличие		Takım Ölçüleri (mm) Dimension (mm) Размеры (мм)					Kesici Uç Insert Пластина	Yedek Parçaları / Spare Parts / Запасные части						
	R	L	DCON	H	LF	WF	DMIN		Levyeye Lever Рычаг	Levyeye Vidası Lever Screw Винт рычага	Altılık Shim Опорная пластина	Altılık Yayısı Shim Spring Втулка рычага	Baskı Pabuçu Wedge Clamp Прижим	Pabuç Vidası Clamp Screw Зажимной винт	Anahtar Allen Key Ключ
A25R PTFNR/L 16C	●	●	25	23	200	17	≥32	TNM. 1604..	APL-01	ALV-02-M6x17	AATN-3-0025	AAY-01	ACK-05	4015-M4x11	AAL-03-3
A32S PTFNR/L 16C	●	●	32	30	250	22	≥40								

R: Sağ / Right / Правый L: Sol / Left / Левый
● Stokta / In Stock / В наличии ○ Stokta Yok / Non Stock Item / Нет в наличии

Sipariş Örneği/Ordering Example/Образец заказа
1 ad./pcs./шт. S25S PSKNR 12C

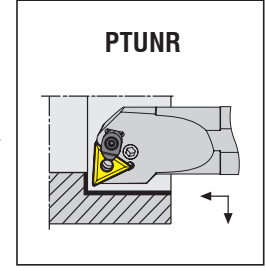
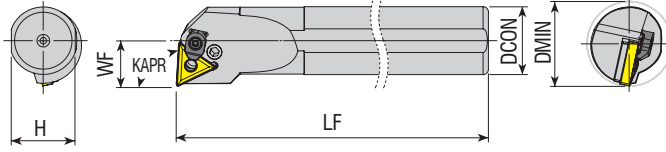

Takım Kodu Ordering Code Код для заказа	Stok Stock Наличие		Takım Ölçüleri (mm) Dimension (mm) Размеры (мм)				Kesici Uç Insert Пластина	Yedek Parçaları / Spare Parts / Запасные части																		
	R	L	DCON	H	LF	WF		DMIN	Leyve Lever Рычаг	Leyve Vidası Lever Screw Виток рычага	Altlık Shim Опорная пластина	Altlık Yayı Shim Spring Втулка рычага	Baskı Pabuçu Wedge Clamp Прижим	Pabuç Vidası Clamp Screw Зажимной винт	Anahtar Allen Key Ключ											
S16P PTUNR/L 16	●	●	16	14.8	170	11	≥20	TNM. 1604..	APL-08	ALV-07-M6x13	-	AAV-07	-	-	AAL-02-2.5											
S20R PTUNR/L 16	●	●	20	18.3	200	13	≥25		APL-01	ALV-01-M6x14	AATN-3-0025	AAV-01	ACK-05	4015-M4x11												
S25S PTUNR/L 16C	●	●	25	23	250	17	≥32			ALV-02-M6x17						AATN-3-0015	AAV-02	ACK-05	4015-M4x11							
S32T PTUNR/L 16C	●	●	32	30	300	22	≥40													APL-02	ALV-03-M8x19	AATN-3-0015	AAV-02	ACK-05	4015-M4x11	
S40U PTUNR/L 16C	●	●	40	37.5	350	27	≥50																			TNM. 2204..
S32T PTUNR/L 22C	●	●	32	30	300	22	≥40	APL-08	ALV-07-M6x13	-	AAV-07	-	-													
S40U PTUNR/L 22C	●	●	40	37.5	350	27	≥50							TNM. 1604..	APL-01	ALV-02-M6x17	AATN-3-0025	AAV-01	ACK-05	4015-M4x11						
S50V PTUNR/L 22C	●	●	50	47	400	35	≥63	APL-02	ALV-03-M8x19	AATN-3-0015	AAV-02	ACK-05	4015-M4x11													
A16M PTUNR/L 16	●	●	16	14.8	150	11	≥20														TNM. 2204..	ALV-03-M8x19	AATN-3-0015	AAV-02	ACK-05	4015-M4x11
A20P PTUNR/L 16	●	●	20	18.3	170	13	≥25	TNM. 1604..	APL-01	ALV-02-M6x17	AATN-3-0025	AAV-01	ACK-05		4015-M4x11											
A25R PTUNR/L 16C	●	●	25	23	200	17	≥32							APL-02		ALV-03-M8x19	AATN-3-0015	AAV-02	ACK-05	4015-M4x11						
A32S PTUNR/L 16C	●	●	32	30	250	22	≥40														TNM. 2204..	ALV-03-M8x19	AATN-3-0015	AAV-02	ACK-05	4015-M4x11
A40T PTUNR/L 16C	●	●	40	37.5	300	27	≥50																			
A32S PTUNR/L 22C	●	●	32	30	250	22	≥40	TNM. 2204..	ALV-03-M8x19	AATN-3-0015	AAV-02	ACK-05	4015-M4x11													
A40T PTUNR/L 22C	●	●	40	37.5	300	27	≥50							APL-02	ALV-03-M8x19	AATN-3-0015	AAV-02	ACK-05	4015-M4x11							

R: Sağ / Right / Правый L: Sol / Left / Левый
● Stokta / In Stock / В наличии ○ Stokta Yok / Non Stock Item / Нет в наличии

Sipariş Örneği/Ordering Example/Образец заказа
1 ad./pcs./шт. S16P PTUNR 16



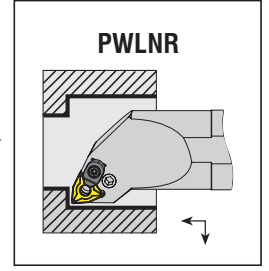
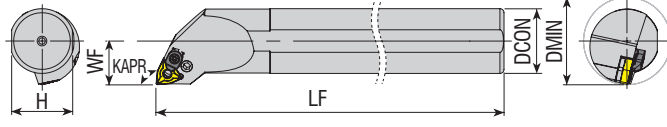

Takım Kodu Ordering Code Код для заказа	Stok Stock Наличие		Takım Ölçüleri (mm) Dimension (mm) Размеры (мм)				Kesici Uç Insert Пластина	Yedek Parçaları / Spare Parts / Запасные части							
	R	L	DCON	H	LF	WF		DMIN	Leyve Lever Рычаг	Leyve Vidası Lever Screw Винт рычага	Altılık Shim Отверная пластина	Altılık Yaylı Shim Spring Втулка рычага	Baskı Pabuçu Wedge Clamp Прижим	Pabuç Vidası Clamp Screw Зажимной винт	Anahtar Allen Key Ключ
S20R PwLNR/L 06	●	●	20	18.3	200	13	≥25	WNM. 0604..	APL-01	ALV-01-M6x14	AAWN-SW317	AAAY-01	-	-	AAL-02-2.5
S25S PwLNR/L 06	●	●	25	23	250	17	≥32			ALV-02-M6x17					
S32T PwLNR/L 06	●	●	32	30	300	22	≥40								
S25S PwLNR/L 08C	●	●	25	23	250	17	≥32								
S32T PwLNR/L 08C	●	●	32	30	300	22	≥40	WNM. 0804..	APL-02	ALV-03-M8x19	AAWN-3-0001	AAAY-02	ACK-05	4015-M4x11	AAL-03-3
S40U PwLNR/L 08C	●	●	40	37.5	350	27	≥50								
S50V PwLNR/L 08C	●	●	50	47	400	35	≥63								
A16M PwLNR/L 06	●	●	16	14.8	150	11	≥20		APL-08	ALV-07-M6x13	-	AAAY-07			
A20P PwLNR/L 06	●	●	20	18.3	170	13	≥25	WNM. 0604..	APL-01	ALV-01-M6x14	AAWN-SW317	AAAY-01	-	-	AAL-02-2.5
A25R PwLNR/L 06	●	●	25	23	200	17	≥32			ALV-02-M6x17					
A32S PwLNR/L 06	●	●	32	30	250	22	≥40								
A40T PwLNR/L 06C	●	○	40	37.5	300	27	≥50								
A25R PwLNR/L 08C	●	●	25	23	200	17	≥32	WNM. 0804..	APL-02	ALV-03-M8x19	AAWN-3-0001	AAAY-02	ACK-05	4015-M4x11	AAL-03-3
A32S PwLNR/L 08C	●	●	32	30	250	22	≥40								
A40T PwLNR/L 08C	●	●	40	37.5	300	27	≥50								
A50U PwLNR/L 08C	●	●	50	47	350	35	≥63								

R: Sağ / Right / Правый L: Sol / Left / Левый
● Stokta / In Stock / В наличии ○ Stokta Yok / Non Stock Item / Нет в наличии

Sipariş Örneği/Ordering Example/Образец заказа
1 ad./pcs./шт. S20R PwLNR 06



*konusulan
the spoken kalite...
quality...*

S-SİSTEM

S-SİSTEM DELİK TORNA KATERLERİ
S-SYSTEM BORING BARS
S-ТИП РАСТОЧНЫЕ ДЕРЖАВКИ



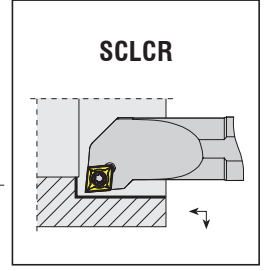
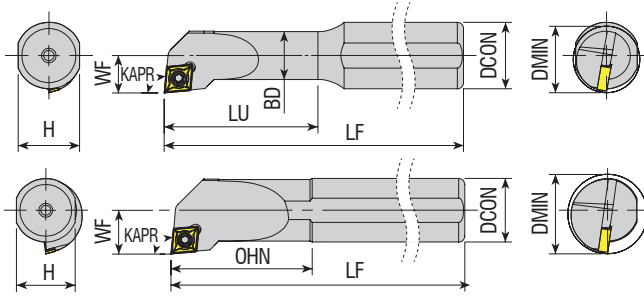

Takım Kodu Ordering Code Код для заказа	Stok Stock Наличие	Takım Ölçüleri (mm) Dimension (mm) Размеры (мм)								Kesici Uç Insert Пластина	Yedek Parçaları / Spare Parts / Запасные части			
		R	L	DCON	BD	H	LU=OHN	LF	WF		DMIN	Sıkma Vidası Screw Зажимной винт	Altlık Shim Опорная пластина	Altlık Vidası Shim Screw Винт опорной пластины
S0608H SCLCR/L 03	● ○	08	5	7.3	18	100	3	≥6	CC.T 030102	4006-M1.6x3.2			80-T06	
S0608H SCLCR/L 06	● ●	08	6	7.3	25	100	4.5	≥8		4008-M2.5x4.5				
S08H SCLCR/L 06	● ●	08	8	7.3	20	100	06	≥11						
S10K SCLCR/L 06	● ●	10	10	09	25	125	07	≥13	CC.T 0602..	4008-M2.5x6	-	-	80-T08	
S12K SCLCR/L 06	● ●	12	12	11	25	125	09	≥16						
S1216P SCLCR/L 06	● ●	16	11.5	14.8	37	170	09	≥16						
S16P SCLCR/L 06	● ●	16	16	14.8	35	170	11	≥20	CC.T 09T3..	4015-M3.5x8			80-T15	
S12K SCLCR/L 09	● ●	12	12	11	30	125	09	≥16						
S1416P SCLCR/L 09	● ●	16	14	14.8	45	170	9.5	≥17						
S16P SCLCR/L 09	● ●	16	16	14.8	35	170	11	≥20	CC.T 09T3..	4015-M3.5x9	-	-	80-T15	
S1620R SCLCR/L 09	● ●	20	16	18.3	50	200	11	≥20						
S20R SCLCR/L 09	● ●	20	20	18.3	40	200	13	≥25						
S25S SCLCR/L 09	● ●	25	25	23	50	250	17	≥32	CC.T 1204..	4015-M3.5x12	AACN-2-0001	AAV-08-M3.5x8	80-T20	
S32T SCLCR/L 09	● ●	32	32	30	60	300	22	≥40						
S25S SCLCR/L 12	● ●	25	25	23	50	250	17	≥32						
S32T SCLCR/L 12	● ●	32	32	30	60	300	22	≥40	CC.T 1204..	4020-M4.5x12	AACN-2-0003	AAV-10-M4.5x8	80-T20	
S40U SCLCR/L 12	● ●	40	40	37.5	70	350	27	≥50		1020-M4.5x16		AAV-07-M4.5x13		
A08H SCLCR/L 06	● ●	08	8	7.3	20	100	06	≥11						
A10H SCLCR/L 06	● ●	10	10	09	25	100	07	≥13	CC.T 0602..	4008-M2.5x6	-	-	80-T08	
A12H SCLCR/L 06	● ●	12	12	11	25	100	09	≥16						
A16M SCLCR/L 09	● ●	16	16	14.8	35	150	11	≥20						
A20P SCLCR/L 09	● ●	20	20	18.3	40	170	13	≥25	CC.T 09T3..	4015-M3.5x9	-	-	80-T15	
A25R SCLCR/L 09	● ●	25	25	23	50	200	17	≥32						
A32S SCLCR/L 09	● ●	32	32	30	60	250	22	≥40						
A25R SCLCR/L 12	● ●	25	25	23	50	200	17	≥32	CC.T 1204..	4020-M4.5x12	AACN-2-0003	AAV-10-M4.5x8	80-T20	

R: Sağ / Right / Правый L: Sol / Left / Левый
● Stokta / In Stock / В наличии ○ Stokta Yok / Non Stock Item / Нет в наличии

Sipariş Örneği/Ordering Example/Образец заказа
1 ad./pcs./шт. S0608H SCLCR 03

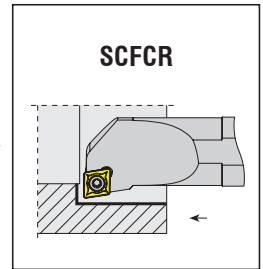
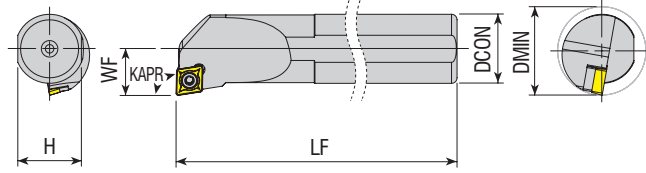

Takım Kodu Ordering Code Код для заказа	Stok Stock Наличие		Takım Ölçüleri (mm) Dimension (mm) Размеры (мм)				Kesici Uç Insert Пластина	Yedek Parçaları / Spare Parts / Запасные части				
	R	L	DCON	H	LF	WF		DMIN	Sıkma Vidası Screw Зажимной винт	Altık Shim Опорная пластина	Altık Vidası Shim Screw Винт опорной пластины	Tork Anahtar Torx Key Торх Ключ
S08H SCFCR/L 06	●	●	08	7.3	100	06	≥11	CC.T 0602..	4008-M2.5x6	-	-	80-T08
S10K SCFCR/L 06	●	●	10	09	125	07	≥13		4015-M3.5x8	-	-	
S12K SCFCR/L 06	●	●	12	11	125	09	≥16		4015-M3.5x9	-	-	
S12K SCFCR/L 09	●	●	12	11	125	09	≥16		4015-M3.5x12	AACN-2-0001	AAV-08-M3.5x8	
S16P SCFCR/L 09	●	●	16	14.8	170	11	≥20	CC.T 09T3..	4015-M3.5x12	-	-	80-T15
S20R SCFCR/L 09	●	●	20	18.3	200	13	≥25		4015-M3.5x12	AACN-2-0001	AAV-08-M3.5x8	
S25S SCFCR/L 09	●	●	25	23	250	17	≥32	CC.T 1204..	4020-M4.5x12	AACN-2-0003	AAV-10-M4.5x8	80-T20
S25S SCFCR/L 12	●	○	25	23	250	17	≥32		1020-M4.5x16	-	AAV-07-M4.5x13	
S32T SCFCR/L 12	○	○	32	30	300	22	≥40		4008-M2.5x6	-	-	80-T08
S40U SCFCR/L 12	○	○	40	37.5	350	27	≥50	CC.T 0602..	4008-M2.5x6	-	-	80-T08
A08H SCFCR/L 06	●	○	08	7.3	100	06	≥11		4008-M2.5x6	-	-	

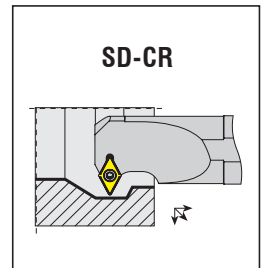
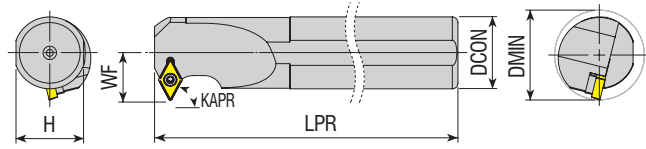

Takım Kodu Ordering Code Код для заказа	Stok Stock Наличие		Takım Ölçüleri (mm) Dimension (mm) Размеры (мм)				Kesici Uç Insert Пластина	Yedek Parçaları / Spare Parts / Запасные части				
	R	L	DCON	H	LPR	WF		DMIN	Sıkma Vidası Screw Зажимной винт	Altık Shim Опорная пластина	Altık Vidası Shim Screw Винт опорной пластины	Tork Anahtar Torx Key Торх Ключ
S10K SD-CR/L 07	●	●	10	9	125	07	≥14	DC.T 0702..	4008-M2.5x6	-	-	80-T08
S12K SD-CR/L 07	●	●	12	11	125	09	≥16		4015-M3.5x11	-	-	
S16P SD-CR/L 07	●	●	16	14.8	170	11	≥20		4015-M3.5x14	AADN-2-0001	AAV-06-M3.5x11	
S20R SD-CR/L 07	●	○	20	18.3	200	13	≥25		4015-M3.5x14	AADN-2-0001	AAV-06-M3.5x11	
S16P SD-CR/L 11	●	●	16	14.8	170	14	≥22	DC.T 11T3..	4015-M3.5x11	-	-	80-T15
S20R SD-CR/L 11	●	●	20	18.3	200	15	≥25		4015-M3.5x14	AADN-2-0001	AAV-06-M3.5x11	
S25S SD-CR/L 11	●	●	25	23	250	18	≥32		4015-M3.5x14	AADN-2-0001	AAV-06-M3.5x11	
S32T SD-CR/L 11	●	●	32	30	300	22	≥40		4015-M3.5x14	AADN-2-0001	AAV-06-M3.5x11	
S40U SD-CR/L 11	●	●	40	37.5	350	27	≥50	4015-M3.5x14	AADN-2-0001	AAV-06-M3.5x11	80-T15	

R: Sağ / Right / Правый L: Sol / Left / Левый
● Stokta / In Stock / В наличии ○ Stokta Yok / Non Stock Item / Нет в наличии

Sipariş Örneği/Ordering Example/Образец заказа
1 ad./pcs./шт. S08H SCFCR 06

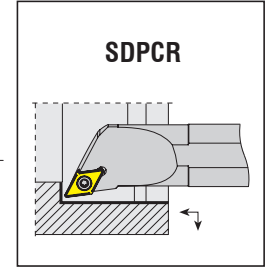
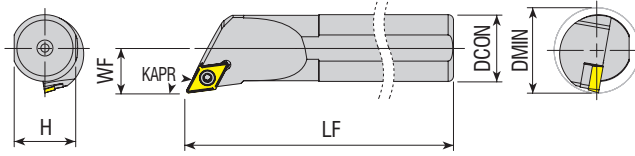

Takım Kodu Ordering Code Код для заказа	Stok Stock Наличие		Takım Ölçüleri (mm) Dimension (mm) Размеры (мм)				Kesici Uç Insert Пластина	Yedek Parçaları / Spare Parts / Запасные части				
	R	L	DCON	H	LF	WF		DMIN	Sıkma Vidası Screw Зажимной винт	Altlık Shim Опорная пластина	Altlık Vidası Shim Screw Винт опорной пластины	Tork Anahtar Torx Key Торх Ключ
	●	●										
S10K SDPCR/L 07	●	●	10	09	125	07	≥13	DC.T 0702..	4008-M2.5x6	-	-	80-T08
S12K SDPCR/L 07	●	●	12	11	125	09	≥16					
S16P SDPCR/L 11	●	●	16	14.8	170	11	≥20	DC.T 11T3..	4015-M3.5x9	-	-	80-T15
S20R SDPCR/L 11	●	●	20	18.3	200	13	≥25		4015-M3.5x11			
S25S SDPCR/L 11	●	●	25	23	250	17	≥32		4015-M3.5x12	AADN-2-0001	AAV-08-M3.5x8	

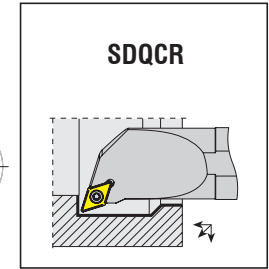
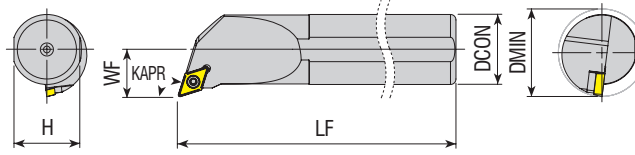

Takım Kodu Ordering Code Код для заказа	Stok Stock Наличие		Takım Ölçüleri (mm) Dimension (mm) Размеры (мм)				Kesici Uç Insert Пластина	Yedek Parçaları / Spare Parts / Запасные части				
	R	L	DCON	H	LF	WF		DMIN	Sıkma Vidası Screw Зажимной винт	Altlık Shim Опорная пластина	Altlık Vidası Shim Screw Винт опорной пластины	Tork Anahtar Torx Key Торх Ключ
	●	●										
S10K SDQCR/L 07	●	●	10	09	125	07	≥13	DC.T 0702..	4008-M2.5x6	-	-	80-T08
S12K SDQCR/L 07	●	●	12	11	125	09	≥16					
S16P SDQCR/L 07	●	●	16	14.8	170	11	≥20	DC.T 11T3..	4015-M3.5x9	-	-	80-T15
S20R SDQCR/L 07	●	●	20	18.3	200	13	≥25		4015-M3.5x11			
S16P SDQCR/L 11	●	●	16	14.8	170	11	≥20		4015-M3.5x12	AADN-2-0001	AAV-08-M3.5x8	
S20R SDQCR/L 11	●	●	20	18.3	200	13	≥25	4015-M3.5x14		AAV-06-M3.5x11		
S25S SDQCR/L 11	●	●	25	23	250	17	≥32	DC.T 11T3..	4015-M3.5x9	-	-	80-T15
S32T SDQCR/L 11	●	●	32	30	300	22	≥40		4015-M3.5x11			
S40U SDQCR/L 11	●	●	40	37.5	350	27	≥50	4015-M3.5x12	AADN-2-0001	AAV-08-M3.5x8		
A10H SDQCR/L 07	●	●	10	09	100	07	≥13	DC.T 0702..	4008-M2.5x6	-	-	80-T08
A12H SDQCR/L 07	●	●	12	11	100	09	≥16					
A16M SDQCR/L 07	●	●	16	14.8	150	11	≥20	DC.T 11T3..	4015-M3.5x9	-	-	80-T15
A20P SDQCR/L 07	●	●	20	18.3	170	13	≥25		4015-M3.5x11			
A16M SDQCR/L 11	●	●	16	14.8	150	11	≥20		4015-M3.5x12	AADN-2-0001	AAV-08-M3.5x8	
A20P SDQCR/L 11	●	●	20	18.3	170	13	≥25	4015-M3.5x14		AAV-06-M3.5x11		
A25R SDQCR/L 11	●	●	25	23	200	17	≥32	DC.T 11T3..	4015-M3.5x9	-	-	80-T15
A32S SDQCR/L 11	●	●	32	30	250	22	≥40		4015-M3.5x11			
	●	●	25	23	200	17	≥32	4015-M3.5x12	AADN-2-0001	AAV-08-M3.5x8		
	●	●	32	30	250	22	≥40	4015-M3.5x14		AAV-06-M3.5x11		

R: Sağ / Right / Правый L: Sol / Left / Левый
● Stokta / In Stock / В наличии ○ Stokta Yok / Non Stock Item / Нет в наличии

Sipariş Örneği/Ordering Example/Образец заказа
1 ad./pcs./шт. S10K SDPCR 07

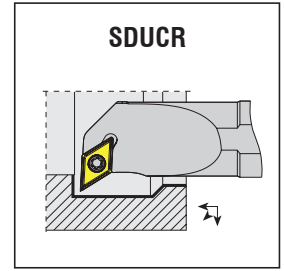
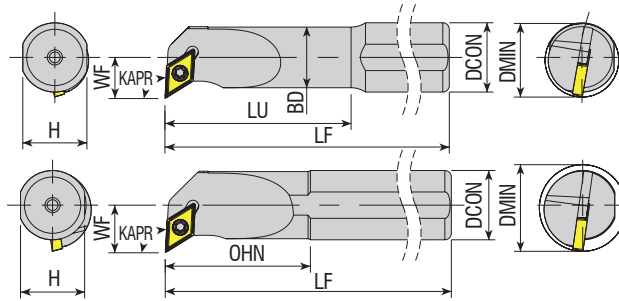

Takım Kodu Ordering Code Код для заказа	Stok Stock Наличие		Takım Ölçüleri (mm) Dimension (mm) Размеры (мм)							Kesici Uç Insert Пластина	Yedek Parçaları / Spare Parts / Запасные части			
	R	L	DCON	BD	H	LU=OHN	LF	WF	DMIN		Sıkma Vidası Screw Зажимной винт	Altık Shim Опорная пластина	Altık Vidası Shim Screw Винт опорной пластины	Tork Anahtar Torx Key Торх Ключ
S0810K SDUCR/L 07	●	●	10	8	09	30	125	08	≥13	DC.T 0702..	4008-M2.5x6	-	-	80-T08
S10K SDUCR/L 07	●	●	10	10	09	25	125	08	≥13					
S12K SDUCR/L 07	●	●	12	12	11	25	125	09	≥16					
S1216P SDUCR/L 07	●	●	16	11.5	14.8	37	170	09	≥16					
S1416P SDUCR/L 07	●	●	16	14	14.8	45	170	9.5	≥17					
S16P SDUCR/L 07	●	●	16	16	14.8	35	170	11	≥20					
S20R SDUCR/L 07	●	●	20	20	18.3	40	200	13	≥25					
S1416P SDUCR/L 11	●	●	16	14	14.8	45	170	11	≥18	DC.T 11T3..	4015-M3.5x9	-	-	80-T15
S16P SDUCR/L 11	●	●	16	16	14.8	35	170	11	≥20					
S1620R SDUCR/L 11	●	●	20	16	18.3	50	200	11	≥20					
S20R SDUCR/L 11	●	●	20	20	18.3	40	200	13	≥25					
S25S SDUCR/L 11	●	●	25	25	23	50	250	17	≥32					
S32T SDUCR/L 11	●	●	32	32	30	60	300	22	≥40					
S40U SDUCR/L 11	●	●	40	40	37.5	70	350	27	≥50					
S50V SDUCR/L 11	●	●	50	50	47	80	400	35	≥63					
A0810H SDUCR/L 07	●	●	10	8	09	30	100	08	≥13	DC.T 0702..	4008-M2.5x6	-	-	80-T08
A10H SDUCR/L 07	●	●	10	10	09	25	100	08	≥13					
A12H SDUCR/L 07	●	●	12	12	11	25	100	09	≥16					
A16M SDUCR/L 07	●	●	16	16	14.8	35	150	11	≥20					
A20P SDUCR/L 07	●	●	20	20	18.3	40	170	13	≥25	DC.T 11T3..	4015-M3.5x9	-	-	80-T15
A16M SDUCR/L 11	●	●	16	16	14.8	35	150	11	≥20					
A20P SDUCR/L 11	●	●	20	20	18.3	40	170	13	≥25					
A25R SDUCR/L 11	●	●	25	25	23	50	200	17	≥32					
A32S SDUCR/L 11	●	●	32	32	30	60	250	22	≥40					
											AADN-2-0001	AAV-08-M3.5x8		

R: Sağ / Right / Правый L: Sol / Left / Левый
● Stokta / In Stock / В наличии ○ Stokta Yok / Non Stock Item / Нет в наличии

Sipariş Örneği/Ordering Example/Образец заказа
1 ad./pcs./шт. S0810K SDUCR 07

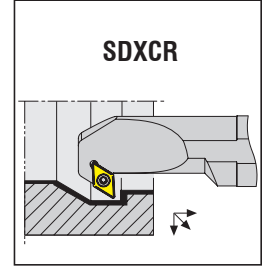
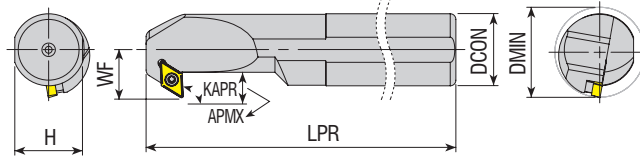

Takım Kodu
Ordering Code
Код для заказа

Stok
Stock
Наличие

Takım Ölçüleri (mm)
Dimension (mm)
Размеры (мм)

Kesici Uç
Insert
Пластина

Yedek Parçaları / Spare Parts / Запасные части

Sıkma Vidası
Screw
Зажимной винт

Altlık
Shim
Опорная пластина

Altlık Vidası
Shim Screw
Винт опорной пластины

Tork Anahtar
Torx Key
Торх Ключ

R L DCON H LPR WF APMX DMIN

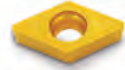

Takım Kodu	R	L	DCON	H	LPR	WF	APMX	DMIN
S12K SDXCR/L 07	●	●	12	11	125	09	4.5	≥16
S16P SDXCR/L 07	●	●	16	14.8	170	11	6.5	≥20
S20R SDXCR/L 07	●	●	20	18.3	200	13	6.5	≥25
S16P SDXCR/L 11	●	●	16	14.8	170	11	6.5	≥20
S20R SDXCR/L 11	●	●	20	18.3	200	14	7.5	≥25
S25S SDXCR/L 11	●	●	25	23	250	17	9	≥32
S32T SDXCR/L 11	●	●	32	30	300	22	12.5	≥40
S40U SDXCR/L 11	●	●	40	37.5	350	27	14.5	≥50
A12H SDXCR/L 07	●	●	12	11	100	09	4.5	≥16
A16M SDXCR/L 07	●	●	16	14.8	150	11	6.5	≥20
A20P SDXCR/L 07	●	●	20	18.3	170	13	6.5	≥25
A16M SDXCR/L 11	●	●	16	14.8	150	11	7.5	≥20
A20P SDXCR/L 11	●	●	20	18.3	170	14	7.5	≥25
A25R SDXCR/L 11	●	●	25	23	200	17	9	≥32
A32S SDXCR/L 11	●	●	32	30	250	22	12.5	≥40

DC.T 0702..

DC.T 11T3..

DC.T 0702..

DC.T 11T3..

4008-M2.5x6

4015-M3.5x11

4015-M3.5x14

4008-M2.5x6

4015-M3.5x11

4015-M3.5x14

-

AADN-2-0001

AADN-2-0001

-

AAV-08-M3.5x8

AAV-06-M3.5x11

AAV-08-M3.5x8

AAV-06-M3.5x11

80-T08

80-T15

80-T08

80-T15

R: Sağ / Right / Правый L: Sol / Left / Левый
● Stokta / In Stock / В наличии ○ Stokta Yok / Non Stock Item / Нет в наличии
Not: "APMX" ölçüleri R0.4'e göre verilmiştir.
Note: Dimensions of "APMX" are given according to R.0,4
Примечание: размеры должны быть R.04

Sipariş Örneği/Ordering Example/Образец заказа
1 ad./pcs./шт. S12K SDXCR 07

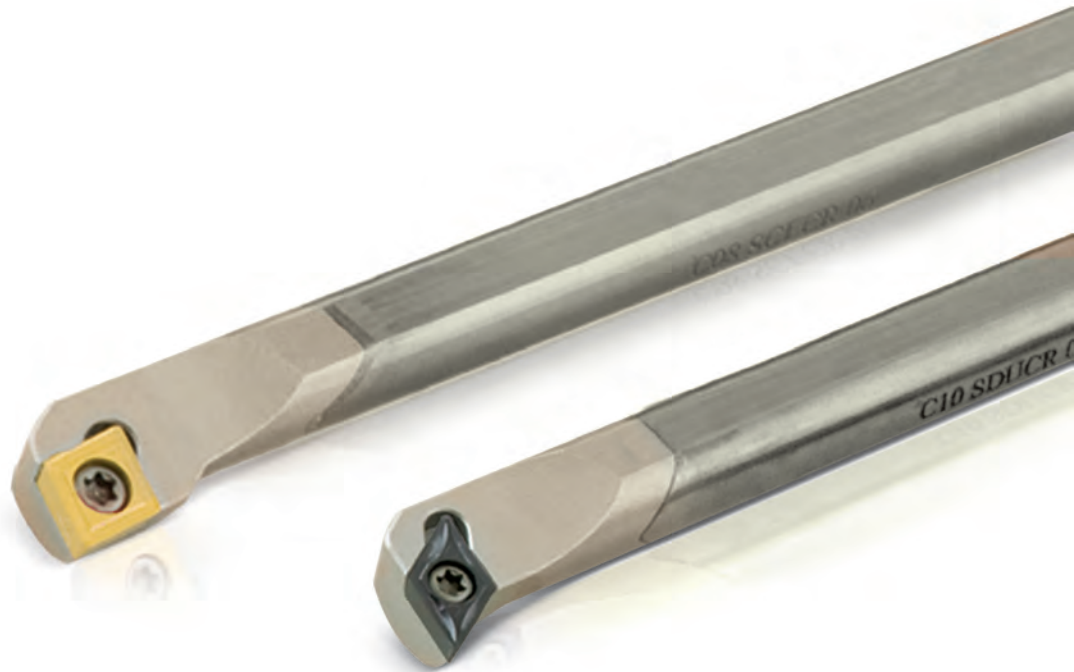

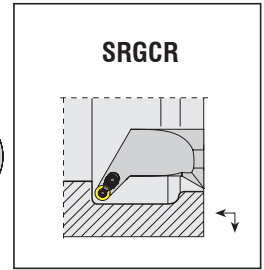
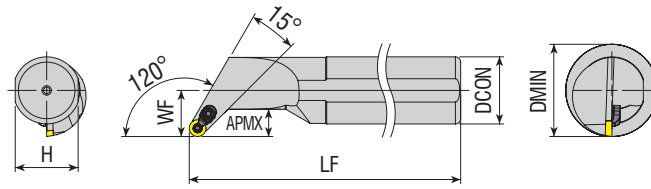

Takım Kodu
Ordering Code
Код для заказа

Stok Stock Наличие	Takım Ölçüleri (mm) Dimension (mm) Размеры (мм)							Kesici Uç Insert Пластина	Yedek Parçaları / Spare Parts / Запасные части						
	R	L	DCON	H	LF	WF	APMX		DMIN	Sıkma Vidası Screw Зажимной винт	Altık Shim Опорная пластина	Altık Vidası Shim Screw Винт опорной пластины	Baskı Pabuçu Shim Screw Spannpratze	Pabuç Vidası Shim Screw Зажимной винт	Anahtar Allen Key Ключ
S16P SRGCR/L 08	●	○	16	14.8	170	11	7	≥22	RCM. 0803..	3008-M3x8	-	-	-	-	80-T08
S20R SRGCR/L 08	●	●	20	18.3	200	13	7	≥26							
S25S SRGCR/L 08C	●	●	25	23	250	17	9.5	≥34							
S32T SRGCR/L 08C	●	○	32	30	300	22	13	≥44							
S40U SRGCR/L 08C	●	○	40	37.5	350	27	15	≥54							
A16M SRGCR/L 08	●	●	16	14.8	150	11	7	≥22							
A20P SRGCR/L 08	●	●	20	18.3	170	13	7	≥26							
A25R SRGCR/L 08C	●	●	25	23	200	17	9.5	≥34							
A32S SRGCR/L 08C	●	●	32	30	250	22	13	≥44							
A40T SRGCR/L 08C	●	●	40	37.5	300	27	15	≥54							



KAPR=45°

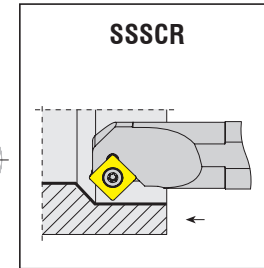
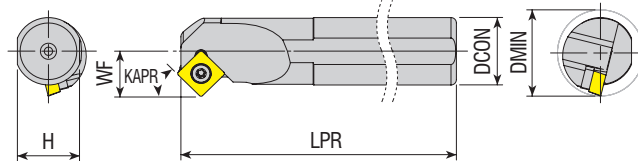

Takım Kodu
Ordering Code
Код для заказа

Stok Stock Наличие	Takım Ölçüleri (mm) Dimension (mm) Размеры (мм)							Kesici Uç Insert Пластина	Yedek Parçaları / Spare Parts / Запасные части			
	R	L	DCON	H	LPR	WF	DMIN		Sıkma Vidası Screw Зажимной винт	Altık Shim Опорная пластина	Altık Vidası Shim Screw Винт опорной пластины	Tork Anahtar Torx Key Торх Ключ
S16P SSSCR/L 09	●	●	16	14.8	170	11	≥20	SC.T 09T3..	4015-M3.5x9	-	-	80-T15
S20R SSSCR/L 09	●	●	20	18.3	200	13	≥25					
S25S SSSCR/L 09	●	●	25	23	250	17	≥32					
S25S SSSCR/L 12	●	●	25	23	250	17	≥32	SC.T 1204..	4020-M4.5x12	AASN-2-0004	AAV-10-M4.5x8	80-T20
S32T SSSCR/L 12	●	○	32	30	300	22	≥40					
S40U SSSCR/L 12	●	○	40	37.5	350	27	≥50					

R: Sağ / Right / Правый L: Sol / Left / Левый
● Stokta / In Stock / В наличии ○ Stokta Yok / Non Stock Item / Нет в наличии

Sipariş Örneği/Ordering Example/Образец заказа
1 ad./pcs./шт. S16P SRGCR 08

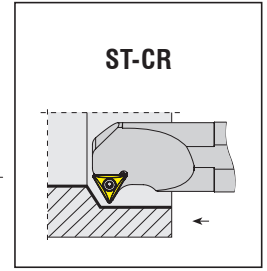
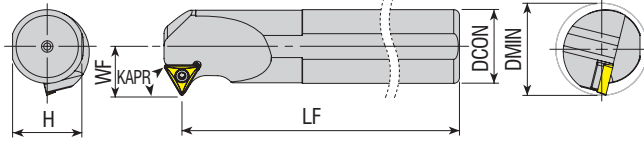

Takım Kodu Ordering Code Код для заказа	Stok Stock Наличие		Takım Ölçüleri (mm) Dimension (mm) Размеры (мм)				Kesici Uç Insert Пластина	Yedek Parçaları / Spare Parts / Запасные части				
	R	L	DCON	H	LF	WF		DMIN	Sıkma Vidası Screw Зажимной винт	Altlık Shim Опорная пластина	Altlık Vidası Shim Screw Винт опорной пластины	Tork Anahtar Torx Key Торх Ключ
	●	○										
S12K ST-CR/L 11	●	●	12	11	125	09	≥17	TC.T 1102..	4008-M2.5x6	-	-	80-T08
S16P ST-CR/L 11	●	○	16	14.8	170	11	≥20					
S20R ST-CR/L 11	●	○	20	18.3	200	13	≥25					
S16P ST-CR/L 16	●	●	16	14.8	170	11	≥20	TC.T 16T3..	4015-M3.5x9	-	-	80-T15
S20R ST-CR/L 16	●	●	20	18.3	200	13	≥25		4015-M3.5x11			
S25S ST-CR/L 16	●	●	25	23	250	17	≥32		4015-M3.5x14			
S32T ST-CR/L 16	●	●	32	30	300	22	≥40	AAV-06-M3.5x11				
S40U ST-CR/L 16	●	●	40	37.5	350	27	≥50					

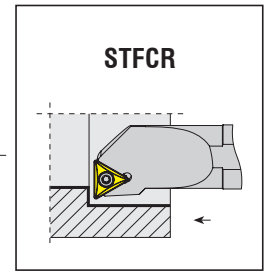
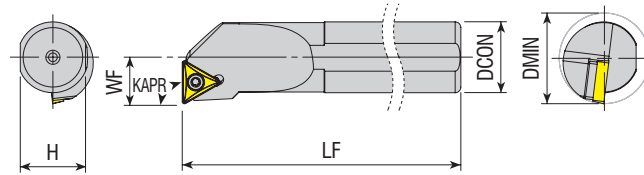

Takım Kodu Ordering Code Код для заказа	Stok Stock Наличие		Takım Ölçüleri (mm) Dimension (mm) Размеры (мм)				Kesici Uç Insert Пластина	Yedek Parçaları / Spare Parts / Запасные части				
	R	L	DCON	H	LF	WF		DMIN	Sıkma Vidası Screw Зажимной винт	Altlık Shim Опорная пластина	Altlık Vidası Shim Screw Винт опорной пластины	Tork Anahtar Torx Key Торх Ключ
	●	○										
S0610F STFCR/L06	●	●	10	09	80	4.5	≥08	TC.T 06T1..	3006-M2x4	-	-	80-T06
S08H STFCR/L 06	●	●	08	7.3	100	06	≥11					
S10K STFCR/L 09	●	●	10	09	125	07	≥13	TC.T 0902..	3007-M2.2x5	-	-	80-T07
S12K STFCR/L 09	●	●	12	11	125	09	≥17					
S12K STFCR/L 11	●	●	12	11	125	09	≥17	TC.T 1102..	4008-M2.5x6	-	-	80-T08
S16P STFCR/L 11	●	●	16	14.8	170	11	≥20					
S20R STFCR/L 11	●	●	20	18.3	200	13	≥25					
S16P STFCR/L 16	●	●	16	14.8	170	11	≥20	TC.T 16T3..	4015-M3.5x9	-	-	80-T15
S20R STFCR/L 16	●	●	20	18.3	200	13	≥25		4015-M3.5x11			
S25S STFCR/L 16	●	●	25	23	250	17	≥32		4015-M3.5x14			
S32T STFCR/L 16	●	●	32	30	300	22	≥40	AAV-06-M3.5x11				
S40U STFCR/L 16	●	○	40	37.5	350	27	≥50					
A10H STFCR/L 11	●	●	10	09	100	07	≥13	TC.T 1102..	4008-M2.5x6	-	-	80-T08
A12H STFCR/L 11	●	●	12	11	100	09	≥17					
A16M STFCR/L 11	●	●	16	14.8	150	11	≥20					

R: Sağ / Right / Правый L: Sol / Left / Левый
● Stokta / In Stock / В наличии ○ Stokta Yok / Non Stock Item / Нет в наличии

Sipariş Örneği/Ordering Example/Образец заказа
1 ad./pcs./шт. S12K ST-CR 11

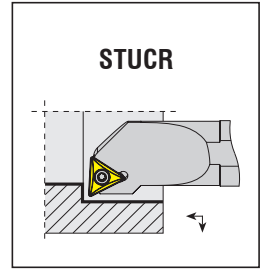
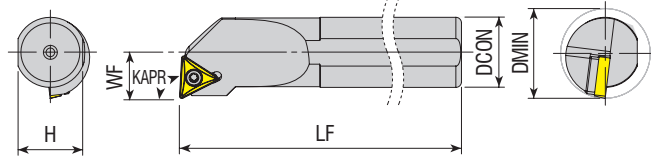

Takım Kodu
Ordering Code
Код для заказа

Stok Stock Наличие	Takım Ölçüleri (mm) Dimension (mm) Размеры (мм)						Kesici Uç Insert Пластина	Yedek Parçaları / Spare Parts / Запасные части			
	R	L	DCON	H	LF	WF		DMIN	Sıkma Vidası Screw Зажимной винт	Altık Shim Опорная пластина	Altık Vidası Shim Screw Винт опорной пластины
●	●	10	09	125	07	≥13	TC.T 0902..	3007-M2.2x5			80-T07
●	●	12	11	125	09	≥16					
●	●	12	11	125	09	≥17	TC.T 1102..	4008-M2.5x6	-	-	80-T08
●	●	16	14.8	170	11	≥20					
●	●	20	18.3	200	13	≥25	TC.T 16T3..	4015-M3.5x9 4015-M3.5x11	-	-	80-T15
●	●	16	14.8	170	11	≥20					
●	●	20	18.3	200	13	≥25	TC.T 16T3..	4015-M3.5x14	AATN-2-0001	AAV-08-M3.5x8 AAV-06-M3.5x11	80-T15
●	●	25	23	250	17	≥32					
●	●	32	30	300	22	≥40	TC.T 16T3..	4015-M3.5x14	AATN-2-0001	AAV-08-M3.5x8 AAV-06-M3.5x11	80-T15
●	●	40	37.5	350	27	≥50					
●	●	10	09	100	07	≥13	TC.T 0902..	3007-M2.2x5			80-T07
●	●	12	11	100	09	≥16					
●	●	12	11	100	09	≥16	TC.T 1102..	4008-M2.5x6	-	-	80-T08
●	●	16	14.8	150	11	≥20					
●	●	20	18.3	170	13	≥25	TC.T 16T3..	4015-M3.5x9 4015-M3.5x11	-	-	80-T15
●	●	16	14.8	150	11	≥20					
●	●	20	18.3	170	13	≥25	TC.T 16T3..	4015-M3.5x14	AATN-2-0001	AAV-08-M3.5x8 AAV-06-M3.5x11	80-T15
●	●	25	23	200	17	≥32					
●	●	32	30	250	22	≥40					

R: Sağ / Right / Правый L: Sol / Left / Левый

● Stokta / In Stock / В наличии ○ Stokta Yok / Non Stock Item / Нет в наличии

Sipariş Örneği/Ordering Example/Образец заказа

1 ad./pcs./шт. S10K STUCR 09



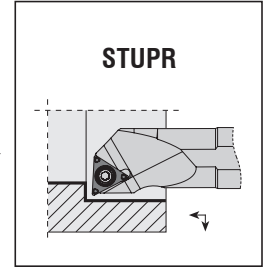
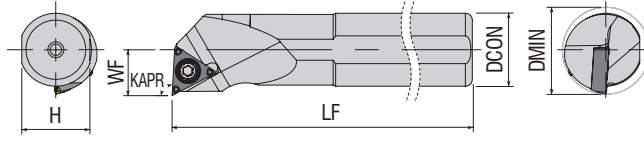

Takım Kodu Ordering Code Код для заказа	Stok Stock Наличие		Takım Ölçüleri (mm) Dimension (mm) Размеры (мм)				Kesici Uç Insert Пластина	Yedek Parçaları / Spare Parts / Запасные части					
	R	L	DCON	H	LF	WF		DMIN	Sıkma Vidası Screw Зажимной винт	Altlık Shim Опорная пластина	Altlık Vidası Shim Screw Винт опорной пластины	Tork Anahtar Torx Key Торх Ключ	
S08H STUPR/L 0802	●	○	08	7.3	100	05	≥10	TP. 0802..	3006-M2x4			80-T06	
S10K STUPR/L 1103	●	○	10	09	125	06	≥12		TP. 1103..	4010-M3x6			
S12K STUPR/L 1103	●	●	12	11	125	09	≥16	4010-M3x8		-	-		
S12M STUPR/L 1103	●	●	12	11	150	08	≥16			4010-M3x8	-		-
S16P STUPR/L 1103	●	●	16	14.8	170	10	≥20						
S16R STUPR/L 1103	●	●	16	14.8	200	10	≥20						
A20R STUPR/L 1103	●	○	20	18.3	200	13	≥25						

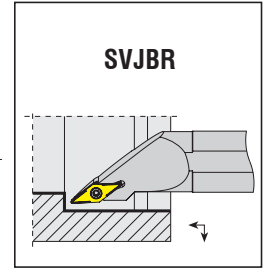
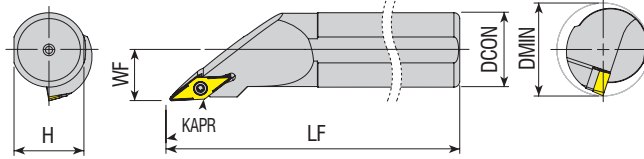

Takım Kodu Ordering Code Код для заказа	Stok Stock Наличие		Takım Ölçüleri (mm) Dimension (mm) Размеры (мм)				Kesici Uç Insert Пластина	Yedek Parçaları / Spare Parts / Запасные части					
	R	L	DCON	H	LF	WF		DMIN	Sıkma Vidası Screw Зажимной винт	Altlık Shim Опорная пластина	Altlık Vidası Shim Screw Винт опорной пластины	Tork Anahtar Torx Key Торх Ключ	
S25S SVJBR/L 16	●	●	25	23	250	17	≥32	VB.T 1604..	4015-M3.5x12	AAVN-2-0002	AAV-08-M3.5x8	80-T15	
S32T SVJBR/L 16	●	●	32	30	300	22	≥40		4015-M3.5x14		AAV-06-M3.5x11		
S40U SVJBR/L 16	●	●	40	37.5	350	27	≥50						

R: Sağ / Right / Правый L: Sol / Left / Левый
● Stokta / In Stock / В наличии ○ Stokta Yok / Non Stock Item / Нет в наличии

Sipariş Örneği/Ordering Example/Образец заказа
1 ad./pcs./шт. S08H STUPR 0802

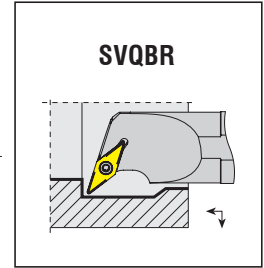
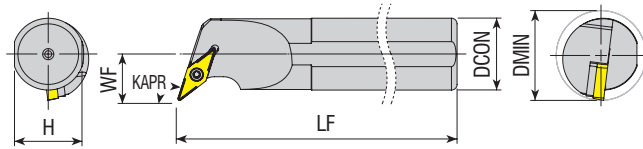

Takım Kodu Ordering Code Код для заказа	Stok Stock Наличие		Takım Ölçüleri (mm) Dimension (mm) Размеры (мм)				Kesici Uç Insert Пластина	Yedek Parçaları / Spare Parts / Запасные части				
	R	L	DCON	H	LF	WF		DMIN	Sıkma Vidası Screw Зажимной винт	Altık Shim Отпорная пластина	Altık Vidası Shim Screw Винт отпорной пластины	Tork Anahtar Torx Key Торх Ключ
	●	●										
S16P SVQBR/L 11	●	●	16	14.8	170	11	≥20	VB.T 1103..	4008-M2.5x6	-	-	80-T08
S20R SVQBR/L 11	●	●	20	18.3	200	13	≥25					
S25S SVQBR/L 16	●	●	25	23	250	17	≥32	VB.T 1604..	4015-M3.5x14	AAVN-2-0002	AAV-08-M3.5x8 AAV-06-M3.5x11	80-T15
S32T SVQBR/L 16	●	●	32	30	300	22	≥40					
S40U SVQBR/L 16	●	●	40	37.5	350	27	≥50	VB.T 1103..	4008-M2.5x6 4015-M3.5x11	-	-	80-T08
A20Q SVQBR/L 11	●	●	20	18.5	180	13	≥25					
A20Q SVQBR/L 16	●	●	20	18.5	180	20	≥30	VB.T 1604..	4015-M3.5x14	AAVN-2-0002	AAV-06-M3.5x11	80-T15
A25S SVQBR/L 16	●	●	25	23	250	17	≥32					
A32S SVQBR/L 16	●	●	32	30	250	22	≥40					

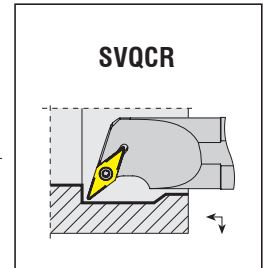
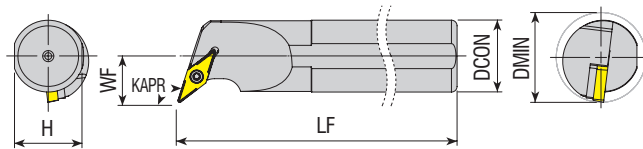

Takım Kodu Ordering Code Код для заказа	Stok Stock Наличие		Takım Ölçüleri (mm) Dimension (mm) Размеры (мм)				Kesici Uç Insert Пластина	Yedek Parçaları / Spare Parts / Запасные части				
	R	L	DCON	H	LF	WF		DMIN	Sıkma Vidası Screw Зажимной винт	Altık Shim Отпорная пластина	Altık Vidası Shim Screw Винт отпорной пластины	Tork Anahtar Torx Key Торх Ключ
	●	●										
S16P SVQCR/L 11	●	●	16	14.8	170	11	≥20	VC.T 1103..	4008-M2.5x6	-	-	80-T08
S20R SVQCR/L 11	●	●	20	18.3	200	13	≥25					
S25S SVQCR/L 16	●	●	25	23	250	17	≥32	VC.T 1604..	4015-M3.5x14	AAVN-2-0002	AAV-08-M3.5x8 AAV-06-M3.5x11	80-T15
S32T SVQCR/L 16	●	●	32	30	300	22	≥40					
S40U SVQCR/L 16	●	●	40	37.5	350	27	≥50	VC.T 1103..	4008-M2.5x6	-	-	80-T08
A16M SVQCR/L 11	●	●	16	14.8	150	11	≥20					
A20P SVQCR/L 11	●	●	20	18.3	170	13	≥25	VC.T 1604..	4015-M3.5x14	AAVN-2-0002	AAV-08-M3.5x8 AAV-06-M3.5x11	80-T15
A25R SVQCR/L 16	●	●	25	23	200	17	≥32					
A32S SVQCR/L 16	●	●	32	30	250	22	≥40					
A40T SVQCR/L 16	●	●	40	37.5	300	27	≥50					

R: Sağ / Right / Правый L: Sol / Left / Левый
● Stokta / In Stock / В наличии ○ Stokta Yok / Non Stock Item / Нет в наличии

Sipariş Örneği/Ordering Example/Образец заказа
1 ad./pcs./шт. S16P SVQBR 11

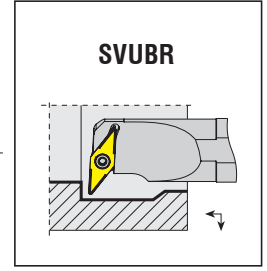
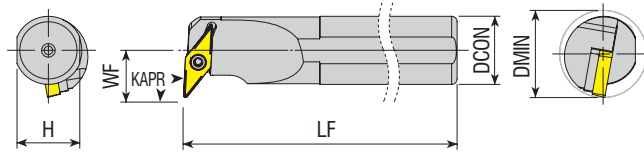

Takım Kodu Ordering Code Код для заказа	Stok Stock Наличие		Takım Ölçüleri (mm) Dimension (mm) Размеры (мм)					Kesici Uç Insert Пластина	Yedek Parçaları / Spare Parts / Запасные части			
	R	L	DCON	H	LF	WF	DMIN		Sıkma Vidası Screw Зажимной винт	Altık Shim Отверная пластина	Altık Vidası Shim Screw Винт отверной пластины	Tork Anahtar Torx Key Торх Ключ
S16P SVUBR/L 11	●	●	16	14.8	170	12.5	≥20	VB.T 1103..	4008-M2.5x6	-	-	80-T08
S20R SVUBR/L 11	●	●	20	18.3	200	13	≥25					
S25S SVUBR/L 16	●	●	25	23	250	19	≥32	VB.T 1604..	4015-M3.5x14	AAVN-2-0002	AAV-06-M3.5x11	80-T15
S32T SVUBR/L 16	●	●	32	30	300	22	≥40					
S40U SVUBR/L 16	●	●	40	37.5	350	27	≥50					
A20Q SVUBR/L 16	●	○	20	18.3	180	20	≥30					
A32S SVUBR/L 16	●	●	32	30	250	22	≥40	4015-M3.5x14	AAVN-2-0002	AAV-06-M3.5x11		

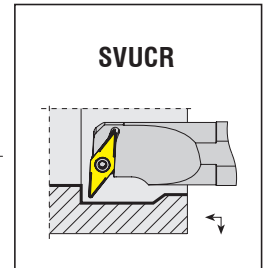
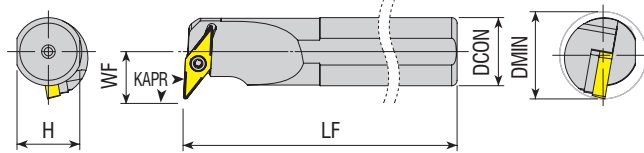

Takım Kodu Ordering Code Код для заказа	Stok Stock Наличие		Takım Ölçüleri (mm) Dimension (mm) Размеры (мм)					Kesici Uç Insert Пластина	Yedek Parçaları / Spare Parts / Запасные части			
	R	L	DCON	H	LF	WF	DMIN		Sıkma Vidası Screw Зажимной винт	Altık Shim Отверная пластина	Altık Vidası Shim Screw Винт отверной пластины	Tork Anahtar Torx Key Торх Ключ
S16P SVUCR/L 11	●	●	16	14.8	170	12.5	≥20	VC.T 1103..	4008-M2.5x6	-	-	80-T08
S20R SVUCR/L 11	●	●	20	18.3	200	13	≥25					
S25S SVUCR/L 16	●	●	25	23	250	19	≥32	VC.T 1604..	4015-M3.5x14	AAVN-2-0002	AAV-06-M3.5x11	80-T15
S32T SVUCR/L 16	●	●	32	30	300	22	≥40					
S40U SVUCR/L 16	●	●	40	37.5	350	27	≥50					
A12K SVUCR/L 07	●	●	12	11	125	9	≥16					
A20P SVUCR/L 11	●	○	20	18.3	170	13	≥25	VC.T 1103..	4008-M2.5x6	-	-	80-T08
A20Q SVUCR/L 11	●	●	20	18.3	180	13	≥25	VC.T 1103..	4008-M2.5x6	-	-	80-T08
A25R SVUCR/L 16	●	●	25	23	200	19	≥32	VC.T 1604..	4015-M3.5x14	AAVN-2-0002	AAV-06-M3.5x11	80-T15

R: Sağ / Right / Правый L: Sol / Left / Левый
● Stokta / In Stock / В наличии ○ Stokta Yok / Non Stock Item / Нет в наличии

Sipariş Örneği/Ordering Example/Образец заказа
1 ad./pcs./шт. S16P SVUBR 11

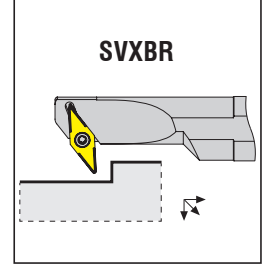
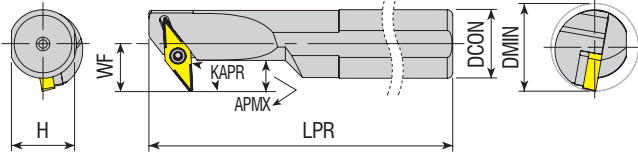

Takım Kodu Ordering Code Код для заказа	Stok Stock Наличие	Takım Ölçüleri (mm) Dimension (mm) Размеры (мм)						Kesici Uç Insert Пластина	Yedek Parçaları / Spare Parts / Запасные части			
		R	L	DCON	H	LPR	WF		APMX	DMIN	Sıkma Vidası Screw Зажимной винт	Altılık Shim Отпорная пластина
S16P SVXBR/L 1102	● ○	16	14.8	170	12.5	7.2	≥20	VBM. 1102..	4008-M2.5x6	-	-	80-T08
S20R SVXBR/L 1102	● ●	20	18.3	200	13	5.7	≥25					
S16P SVXBR/L 11	● ●	16	14.8	170	12.5	7.2	≥20	VB.T 1103..	4015-M3.5x14	AAVN-2-0002	AAV-06-M3.5x11	80-T15
S20R SVXBR/L 11	● ●	20	18.3	200	13	5.7	≥25					
S25S SVXBR/L 16	● ●	25	23	250	19	10.2	≥32	VB.T 1604..	4015-M3.5x14	AAVN-2-0002	AAV-06-M3.5x11	80-T15
S32T SVXBR/L 16	● ●	32	30	300	22	11.7	≥40					
S40U SVXBR/L 16	● ●	40	37.5	350	27	14.3	≥50					

Not: "APMX" ölçüleri R0.4'e göre verilmiştir.
Note: Dimensions of "APMX" are given according to R.0.4
Примечание: размеры должны быть R.04

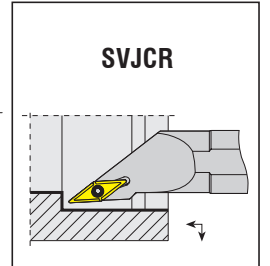
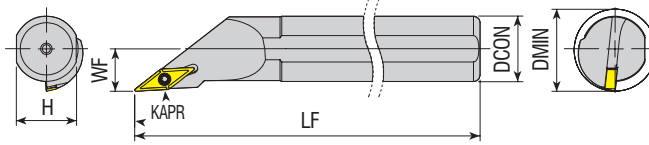

Takım Kodu Ordering Code Код для заказа	Stok Stock Наличие	Takım Ölçüleri (mm) Dimension (mm) Размеры (мм)						Kesici Uç Insert Пластина	Yedek Parçaları / Spare Parts / Запасные части			
		R	L	DCON	H	LF	WF		DMIN	Sıkma Vidası Screw Зажимной винт	Altılık Shim Отпорная пластина	Altılık Vidası Shim Screw Винт отпорной пластины
S12K SVJCR/L 11	● ●	12	11	125	7	≥13	VC.T 1103..	4008-M2.5x6	-	-	80-T08	
S16P SVJCR/L 11	● ●	16	14.8	170	11	≥20						
S20R SVJCR/L 11	● ●	20	18.3	200	13	≥25						
A12H SVJCR/L 11	● ●	12	11	100	07	≥13						
A16M SVJCR/L 11	● ●	16	14.8	150	11	≥20						
A20P SVJCR/L 11	● ●	20	18.3	170	13	≥25						

R: Sağ / Right / Правый L: Sol / Left / Левый
● Stokta / In Stock / В наличии ○ Stokta Yok / Non Stock Item / Нет в наличии

Sipariş Örneği/Ordering Example/Образец заказа
1 ad./pcs./шт. S16P SVXBR 1102

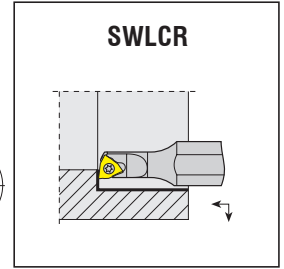
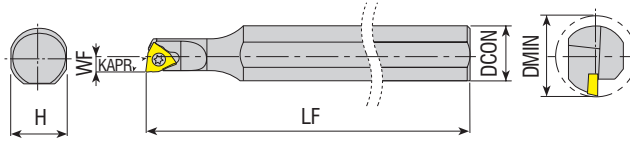

Takım Kodu Ordering Code Код для заказа	Stok Stock Наличие	Takım Ölçüleri (mm) Dimension (mm) Размеры (мм)						Kesici Uç Insert Пластина	Yedek Parçaları / Spare Parts / Запасные части			
		DCON	H	LF	WF	DMIN	Sıkma Vidası Screw Зажимной винт		Altlık Shim Опорная пластина	Altlık Vidası Shim Screw Винт опорной пластины	Tork Anahtar Torx Key Торх Ключ	
S0608H SWLCR 03	●	08	7.3	100	04	≥08	WC.. 0302..		4008-M2.5x4	-	-	80-T08
S0810K SWLCR 03	●	10	09	125	06	≥10						

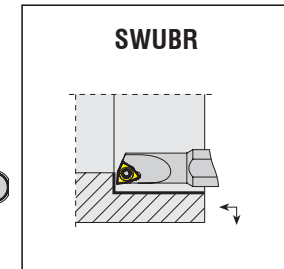
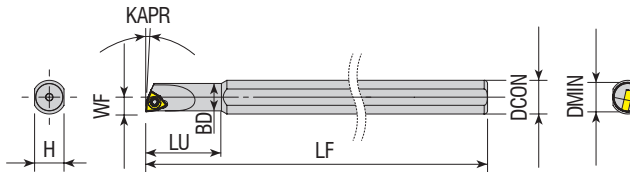

Takım Kodu Ordering Code Код для заказа	Stok Stock Наличие	Takım Ölçüleri (mm) Dimension (mm) Размеры (мм)								Kesici Uç Insert Пластина	Yedek Parçaları / Spare Parts / Запасные части				
		DCON	BD	H	LU	LF	DMIN	WF	Sıkma Vidası Screw Зажимной винт		Altlık Shim Опорная пластина	Altlık Vidası Shim Screw Винт опорной пластины	Tork Anahtar Torx Key Торх Ключ		
S0610H SWUBR 06	●	10	5	7.3	18	100	≥6	3	WBGТ 060102-L		3006-M2x3.3	-	-	80-T06	
S08H SWUBR 06-5.5	●	08	5	7.3	18	100	≥5.7	2.75							3006-M2x4
S08H SWUBR 06-7	●	08	6.5	7.3	18	100	≥7	3.5							

R: Sağ / Right / Правый L: Sol / Left / Левый

● Stokta / In Stock / В наличии ○ Stokta Yok / Non Stock Item / Нет в наличии

KYCR-ISCR Ucuna Uygundur. / Compatible with KYCR-ISCR Insert. / Под пластину KYCR-ISCR

Sipariş Örneği/Ordering Example/Образец заказа

1 ad./pcs./шт. S0608H SWLCR 03

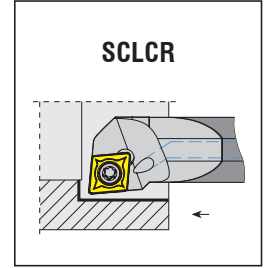
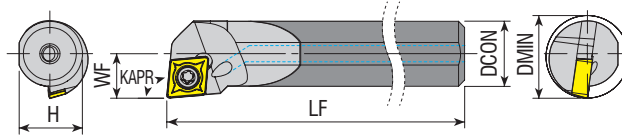

Takım Kodu Ordering Code Код для заказа	Stok Stock Наличие		Takım Ölçüleri (mm) Dimension (mm) Размеры (мм)					Kesici Uç Insert Пластина	Yedek Parçaları / Spare Parts / Запасные части			
	R	L	DCON	H	LF	WF	DMIN		Sıkma Vidası Screw Зажимной винт	Altlık Shim Отпорная пластина	Altlık Vidası Shim Screw Винт отпорной пластины	Tork Anahtar Torx Key Торх Ключ
C06J SCLCR/L 06	●	○	6	5.7	110	4.5	≥8	CC.T 0602..				
E08K SCLCR/L 06	●	●	8	7.5	125	6	≥11					
E10M SCLCR/L 06	●	●	10	9.5	150	7	≥13					
E12Q SCLCR/L 06	●	●	12	11	180	9	≥16					
E16R SCLCR/L 09	●	●	16	15	200	11	≥20	CC.T 09T3..				
E20S SCLCR/L 09	●	●	20	19	250	13	≥24					

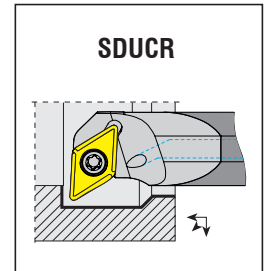
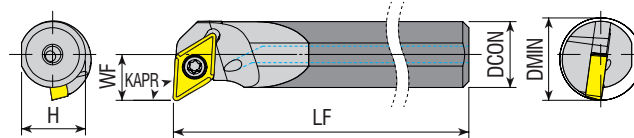

Takım Kodu Ordering Code Код для заказа	Stok Stock Наличие		Takım Ölçüleri (mm) Dimension (mm) Размеры (мм)					Kesici Uç Insert Пластина	Yedek Parçaları / Spare Parts / Запасные части			
	R	L	DCON	H	LF	WF	DMIN		Sıkma Vidası Screw Зажимной винт	Altlık Shim Отпорная пластина	Altlık Vidası Shim Screw Винт отпорной пластины	Tork Anahtar Torx Key Торх Ключ
E10M SDUCR/L 07	●	●	10	9.5	150	8	≥13	DC.T 0702..				
E12Q SDUCR/L 07	●	●	12	11	180	9	≥16					
E16R SDUCR/L 11	●	●	16	15	200	11	≥20	DC.T 11T3..				
E20S SDUCR/L 11	●	●	20	18.3	250	12	≥23					

R: Sağ / Right / Правый L: Sol / Left / Левый

● Stokta / In Stock / В наличии ○ Stokta Yok / Non Stock Item / Нет в наличии

Sipariş Örneği/Ordering Example/Образец заказа

1 ad./pcs./шт. C06J SCLCR 06



KAPR=90°

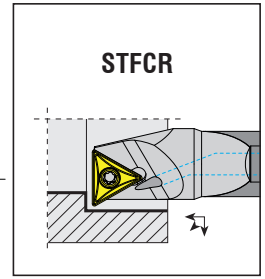
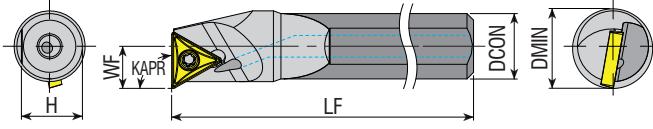

Takım Kodu
Ordering Code
Код для заказа

Stok
Stock
Наличие

Takım Ölçüleri (mm)
Dimension (mm)
Размеры (мм)

Kesici Uç
Insert
Пластина

Yedek Parçaları / Spare Parts / Запасные части

Sıkma Vidası
Screw
Зажимной винт

Altlık
Shim
Опорная пластина

Altlık Vidası
Shim Screw
Винт опорной пластины

Tork Anahtar
Torx Key
Torx Ключ

R	L	DCON	H	LF	WF	DMIN	Kesici Uç Insert Пластина	Sıkma Vidası Screw Зажимной винт	Altlık Shim Опорная пластина	Altlık Vidası Shim Screw Винт опорной пластины	Tork Anahtar Torx Key Torx Ключ
●	○	10	9.5	150	6	12					
●	○	12	11	180	8	15	TC.T 0902..	3007-M2.2x5	-	-	80-T07
●	○	12	11	180	8	15	TC.T 1102..	4008-M2.5x6	-	-	80-T08



KAPR=93°

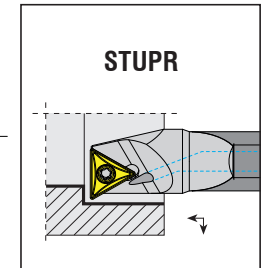
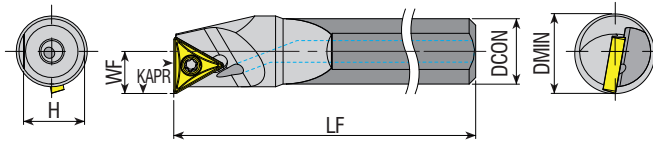

Takım Kodu
Ordering Code
Код для заказа

Stok
Stock
Наличие

Takım Ölçüleri (mm)
Dimension (mm)
Размеры (мм)

Kesici Uç
Insert
Пластина

Yedek Parçaları / Spare Parts / Запасные части

Sıkma Vidası
Screw
Зажимной винт

Altlık
Shim
Опорная пластина

Altlık Vidası
Shim Screw
Винт опорной пластины

Tork Anahtar
Torx Key
Torx Ключ

R	L	DCON	H	LF	WF	DMIN	Kesici Uç Insert Пластина	Sıkma Vidası Screw Зажимной винт	Altlık Shim Опорная пластина	Altlık Vidası Shim Screw Винт опорной пластины	Tork Anahtar Torx Key Torx Ключ
●	○	12	11	180	8	15					
●	○	16	15	200	11	20	TP. 1103..	4010-M3x8	-	-	80-T10

R: Sağ / Right / Правый L: Sol / Left / Левый

● Stokta / In Stock / В наличии ○ Stokta Yok / Non Stock Item / Нет в наличии

Sipariş Örneği/Ordering Example/Образец заказа

1 ad./pcs./шт. E10M STF CR 09

SCLCR

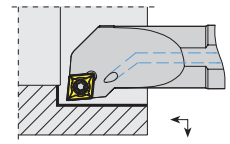

SET-A/SCLCR/L

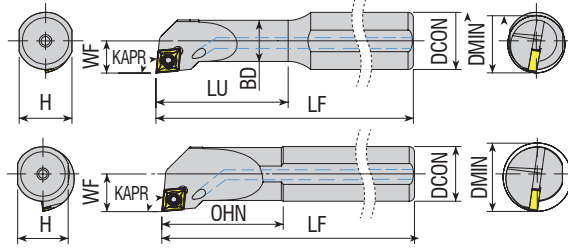

Takım Kodu
Ordering Code
Код для заказа

Stok
Stock
Наличие

Takım Ölçüleri (mm)
Dimension (mm)
Размеры (мм)

Kesici Uç
Insert
Пластина

Yedek Parçaları / Spare Parts / Запасные части

Sıkma Vidası
Screw
Зажимной винт

Altlık
Shim
Опорная пластина

Altlık Vidası
Shim Screw
Винт опорной пластины

Tork Anahtar
Torx Key
Торх Ключ

R	L	DCON	BD	H	LU=OHN	LF	WF	DMIN
---	---	------	----	---	--------	----	----	------



A08H SCLCR/L 06
A10H SCLCR/L 06
A12H SCLCR/L 06
A16M SCLCR/L 09

●●	●●	8	8	7.3	20	100	6	≥11
●●	●●	10	10	9	25	100	7	≥13
●●	●●	12	12	11	25	100	9	≥16
●●	●●	16	16	14.8	35	150	11	≥20

CC.T 0602..

4008-M2.5x6

-

-

80-T08

CC.T 09T3..

4015-M3.5x9

-

-

80-T15

SET-E/SCLCR/L

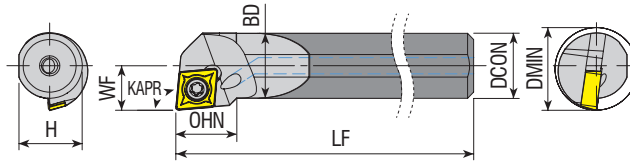

SCLCR

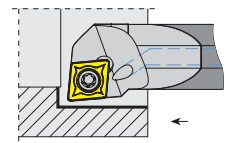

Takım Kodu
Ordering Code
Код для заказа

Stok
Stock
Наличие

Takım Ölçüleri (mm)
Dimension (mm)
Размеры (мм)

Kesici Uç
Insert
Пластина

Yedek Parçaları / Spare Parts / Запасные части

Sıkma Vidası
Screw
Зажимной винт

Altlık
Shim
Опорная пластина

Altlık Vidası
Shim Screw
Винт опорной пластины

Tork Anahtar
Torx Key
Торх Ключ

R	L	DCON	BD	H	OHN	LF	WF	DMIN
---	---	------	----	---	-----	----	----	------

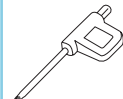

E08K SCLCR/L 06
E10M SCLCR/L 06
E12Q SCLCR/L 06
E16R SCLCR/L 09

●○	○	8	8	7.5	10	125	6	≥11
●○	○	10	10	9.5	10	150	7	≥13
●○	○	12	12	11	12	180	9	≥16
●○	○	16	16	15	15	200	11	≥20

CC.T 0602..

4008-M2.5x6

-

-

80-T08

CC.T 09T3..

4015-M3.5x9

-

-

80-T15

SET-S/SCLCR/L

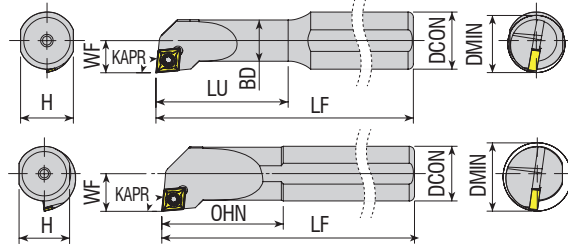

SCLCR

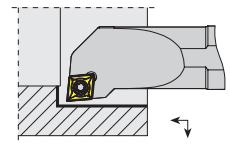

Takım Kodu
Ordering Code
Код для заказа

Stok
Stock
Наличие

Takım Ölçüleri (mm)
Dimension (mm)
Размеры (мм)

Kesici Uç
Insert
Пластина

Yedek Parçaları / Spare Parts / Запасные части

Sıkma Vidası
Screw
Зажимной винт

Altlık
Shim
Опорная пластина

Altlık Vidası
Shim Screw
Винт опорной пластины

Tork Anahtar
Torx Key
Торх Ключ

R	L	DCON	BD	H	LU=OHN	LF	WF	DMIN
---	---	------	----	---	--------	----	----	------



S08H SCLCR/L 06
S10K SCLCR/L 06
S12K SCLCR/L 06
S16P SCLCR/L 09

●●	●●	8	8	7.3	20	100	6	≥11
●●	●●	10	10	9	25	125	7	≥13
●●	●●	12	12	11	25	125	9	≥16
●●	●●	16	16	14.8	35	170	11	≥20

CC.T 0602..

4008-M2.5x6

-

-

80-T08

CC.T 09T3..

4015-M3.5x9

-

-

80-T15

R: Sağ / Right / Правый L: Sol / Left / Левый

● Stokta / In Stock / В наличии ○ Stokta Yok / Non Stock Item / Нет в наличии

Sipariş Örneği/Ordering Example/Образец заказа

1 ad./pcs./шт. A08H SCLCR 06

SET-A/SDUCR/L

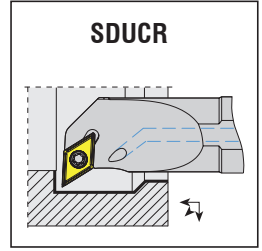
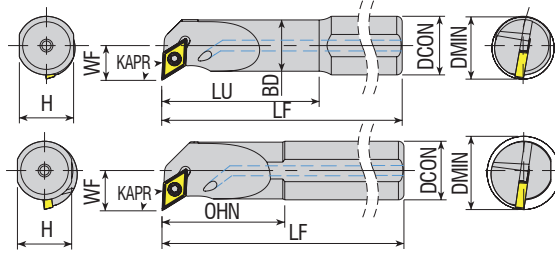

Takım Kodu
Ordering Code
Код для заказа

Stok Stock Наличие	Takım Ölçüleri (mm) Dimension (mm) Размеры (мм)								Kesici Uç Insert Пластина	Yedek Parçaları / Spare Parts / Запасные части									
	R	L	DCON	BD	H	LU=OHN	LF	WF		DMIN	Sıkma Vidası Screw Зажимной винт	Altlık Shim Опорная пластина	Altlık Vidası Shim Screw Винт опорной пластины	Tork Anahtar Torx Key Торх Ключ					
A10H SDUCR/L 07	●	●	10	10	09	25	100	08	≥13										
A12H SDUCR/L 07	●	●	12	12	11	25	100	09	≥16						DC.T 0702..	4008-M2.5x6	-	-	80-T08
A16M SDUCR/L 11	●	●	16	16	14.8	35	150	11	≥20						DC.T 11T3..	4015-M3.5x9	-	-	80-T15

SET-E/SDUCR/L

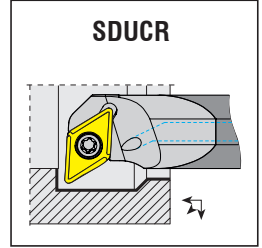
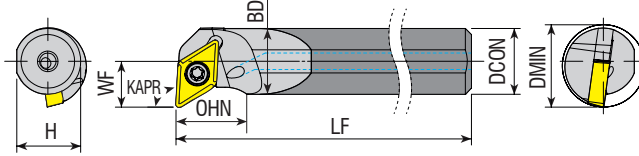

Takım Kodu
Ordering Code
Код для заказа

Stok Stock Наличие	Takım Ölçüleri (mm) Dimension (mm) Размеры (мм)								Kesici Uç Insert Пластина	Yedek Parçaları / Spare Parts / Запасные части									
	R	L	DCON	BD	H	OHN	LF	WF		DMIN	Sıkma Vidası Screw Зажимной винт	Altlık Shim Опорная пластина	Altlık Vidası Shim Screw Винт опорной пластины	Tork Anahtar Torx Key Торх Ключ					
E10M SDUCR/L 07	●	○	10	10	9.5	09	150	8	≥13										
E12Q SDUCR/L 07	●	○	12	12	11	10	180	9	≥16						DC.T 0702..	4008-M2.5x6	-	-	80-T08
E16R SDUCR/L 11	●	○	16	16	15	12	200	11	≥20						DC.T 11T3..	4015-M3.5x9	-	-	80-T15

SET-S/SDUCR/L

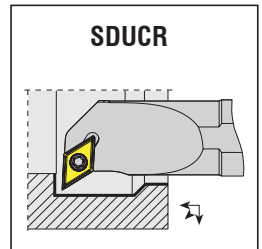
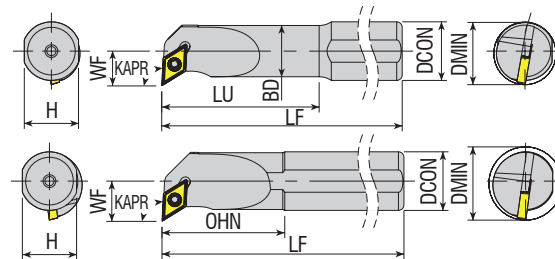

Takım Kodu
Ordering Code
Код для заказа

Stok Stock Наличие	Takım Ölçüleri (mm) Dimension (mm) Размеры (мм)								Kesici Uç Insert Пластина	Yedek Parçaları / Spare Parts / Запасные части									
	R	L	DCON	BD	H	LU=OHN	LF	WF		DMIN	Sıkma Vidası Screw Зажимной винт	Altlık Shim Опорная пластина	Altlık Vidası Shim Screw Винт опорной пластины	Tork Anahtar Torx Key Торх Ключ					
S10K SDUCR/L 07	●	●	10	10	9	25	125	8	≥13										
S12K SDUCR/L 07	●	●	12	12	11	25	125	9	≥16						DC.T 0702..	4008-M2.5x6	-	-	80-T08
S16P SDUCR/L 11	●	●	16	16	14.8	35	170	11	≥20						DC.T 11T3..	4015-M3.5x9	-	-	80-T15

R: Sağ / Right / Правый L: Sol / Left / Левый
● Stokta / In Stock / В наличии ○ Stokta Yok / Non Stock Item / Нет в наличии

Sipariş Örneği/Ordering Example/Образец заказа
1 ad./pcs./шт. SET-A/SDUCR



konusulan
the spoken kalite...
quality...

TIRLAMAZ

TIRLAMAZ TAKIMLAR
ANTIVIBRATION TOOLS
АНТИВИБРАЦИОННЫЕ ДЕРЖАВКИ



AKKO **A** **TT** **B** **D16** **204** **10D** **H** **E**

2 Takım Tipi Tool Type Тип Инструмента	3 Gövde Body Корпус	4 Bağlantı Çapı Connection Diameter Диаметр Соединение	5 Takım Boyu Overall length Общая Длина инструмента	6 Bağlama Boyu Overhang maximum Максимум длина соединения	7 İçten Soğutmalı With Coolant Hole С охлаждающим отверстием
Tırlamaz Takım Anti Vibration Tool Антивибрационная Державка					
8 Takım Malzemesi Type of Boring Bar Тип расточной оправки					
Karbür Takviyeli Carbide reinforced Армированный карбид					

AKKO **A** **TT** **C** **A** **16** **SDUCR11**

2 Takım Tipi Tool Type Тип Инструмента	3 Kartuş Kodu Cartridge Code Код картриджа	4 İçten Soğutmalı With Coolant Hole С охлаждающим отверстием	5 Bağlama Çapı Connection Diameter Диаметр Соединение
Tırlamaz Takım Kartuşu Anti Vibration Tool Cartridge Картриджи для Антивибрационных инструментов	Kartuş Cartridge Картридж		Ø16 - Ø20 - Ø25 Ø32 - Ø40
2 Kartuş Tipi Cartridge Type Тип Картриджа	SDUCR/L, SCLCR/L, SVUCR/L, TCLNR/L, TDUNR/L		

AKKO **A** **TT** **C** **16-25**

2 Takım Tipi Tool Type Тип Инструмента	3 Kartuş Cartridge Картридж	4 Kullanılan Gövde Çap Aralığı Usable diameter range for body Используемый диапазон диаметров для корпуса
Tırlamaz Takım Kartuşu Anti Vibration Tool Cartridge Картриджи для Антивибрационных инструментов	Merkezeleme Kartuş Kodu Centering Cartridge Code Код для центрирующего картриджа	ATTB-D16/D20/D25 ATTB-D32/D40/D50/D60

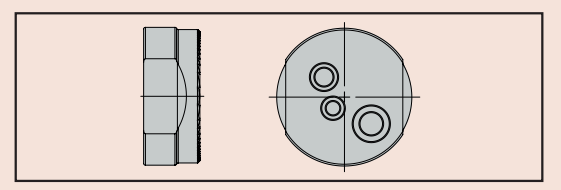

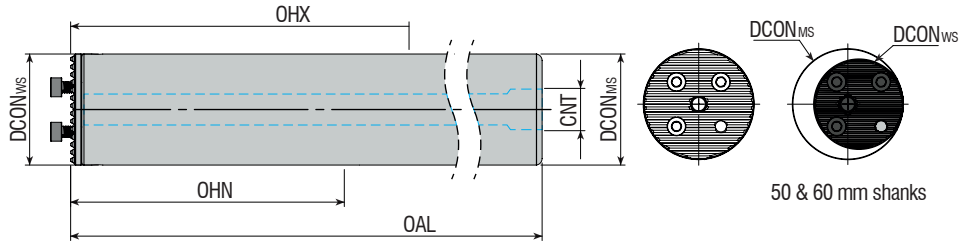

Takım Kodu
Ordering Code
Код для заказа

Stok
Stock
Наличие

Takım Ölçüleri (mm)
Dimension (mm)
Размеры (мм)

Yedek Parçaları / Spare Parts / Запасные части

Montaj Vidası
Shim Screw
Винт опорной пластины

Montaj Vida Anahtar
Mounting Screw Key
Монтажный винт шестигранной под шестигранник

Takım Kodu Ordering Code Код для заказа	Stok Stock Наличие	DCONMS	DCONWS	OAL	OHN	OHX	CNT	DCON		Montaj Vidası Shim Screw Винт опорной пластины	Montaj Vida Anahtar Mounting Screw Key Монтажный винт шестигранной под шестигранник
								DMIN	DCON		
ATTB-D16-156-7D-H	○	16	16	156	55	92	G1/8	16	20	2525-M3X10	AAL-02-2.5
ATTB-D16-204-10D-H-E	○	16	16	204	96	140	G1/8	16	20		
ATTB-D20-200-7D-H	○	20	20	200	70	120	G1/4	20	25	M3.5X10	AAL-02-2.5
ATTB-D20-260-10D-H-E	○	20	20	260	120	180	G1/4	20	25		
ATTB-D25-255-7D-H	○	25	25	255	88	158	G1/4	25	32	2503-M4X12	AAL-03-3
ATTB-D25-330-10D-H	○	25	25	330	155	230	G1/4	25	32		
ATTB-D32-320-7D-H	○	32	32	320	100	192	G3/8	32	40	2504-M5X16	AAL-05-4
ATTB-D32-416-10D-H	○	32	32	416	192	288	G3/8	32	40		
ATTB-D40-408-7D-H	○	40	40	408	128	248	G1/2	40	50	2505-M6X16	AAL-07-5
ATTB-D40-528-10D-H	○	40	40	528	248	368	G1/2	40	50		
ATTB-D50-519-7D-H	●	50	40	519	168	318	G1/2	40	63	2505-M6X16	AAL-07-5
ATTB-D50-669-10D-H	○	50	40	669	318	468	G1/2	40	63		
ATTB-D60-628-7D-H	○	60	40	628	208	388	G3/4	40	80	2505-M6X16	AAL-07-5
ATTB-D60-808-10D-H	○	60	40	808	388	568	G3/4	40	80		

R: Sağ / Right / Правый L: Sol / Left / Левый

● Stokta / In Stock / В наличии ○ Stokta Yok / Non Stock Item / Нет в наличии

Sipariş Örneği/Ordering Example/Образец заказа

1 ad./pcs./шт. ATTB-D16-156-7D-H



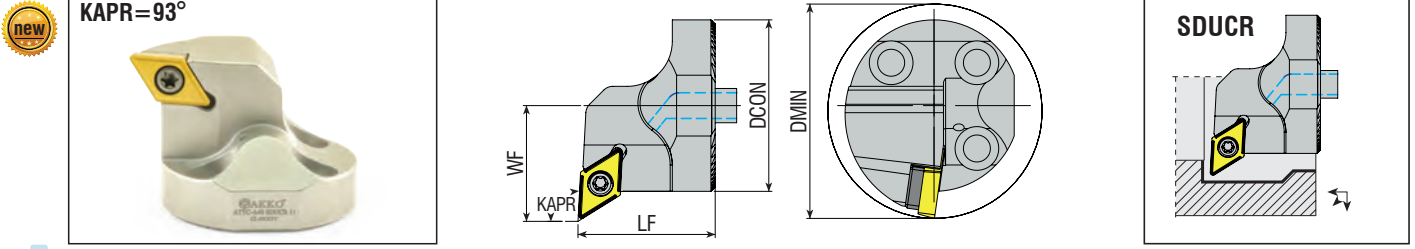

Takım Kodu Ordering Code Код для заказа	Stok Stock Наличие		Takım Ölçüleri (mm) Dimension (mm) Размеры (мм)				Kesici Uç Insert Пластина	Yedek Parçaları / Spare Parts / Запасные части			
	R	L	DCON	LF	WF	DMIN		Sıkma Vidası Screw Зажимной винт	Aitlik Shim Опорная пластина	Aitlik Vidası Shim Screw Винт опорной пластины	Tork Anahtar Torx Key Торх Ключ
ATTC-A16 SDUCR/L 07	○	○	16	20	11	20	DC.T 0702..	4008-M2.5x6	-	-	80-T08
ATTC-A20 SDUCR/L 11	○	○	20	20	13	25		4015-M3.5x11	-	-	
ATTC-A25 SDUCR/L 11	○	○	25	23	17	32	DC.T 11T3..	4015-M3.5x12	AADN-2-0001	AAV-08-M3.5x8	80-T15
ATTC-A32 SDUCR/L 11	○	○	32	32	22	40		4015-M3.5x14		AAV-06-M3.5x11	
ATTC-A40 SDUCR/L 11	●	●	40	32	27	50					

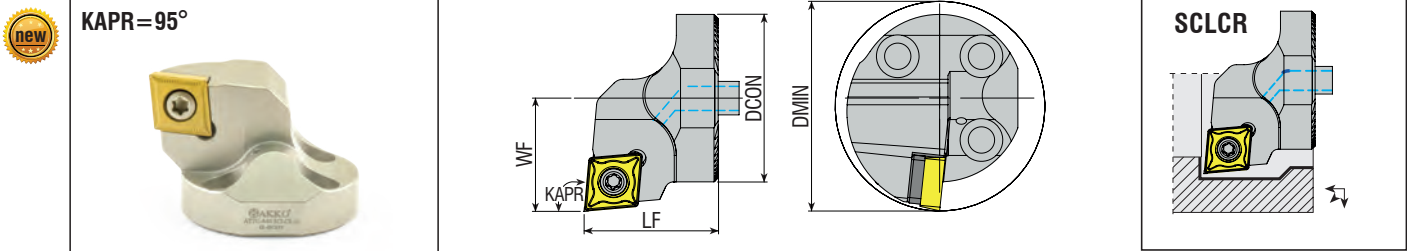

Takım Kodu Ordering Code Код для заказа	Stok Stock Наличие		Takım Ölçüleri (mm) Dimension (mm) Размеры (мм)				Kesici Uç Insert Пластина	Yedek Parçaları / Spare Parts / Запасные части			
	R	L	DCON	LF	WF	DMIN		Sıkma Vidası Screw Зажимной винт	Aitlik Shim Опорная пластина	Aitlik Vidası Shim Screw Винт опорной пластины	Tork Anahtar Torx Key Торх Ключ
ATTC-A16 SCLCR/L 06	○	○	16	20	11	20	CC.T 0602..	4008-M2.5x6	-	-	80-T08
ATTC-A20 SCLCR/L 09	○	○	20	20	13	25		4015-M3.5x9	-	-	
ATTC-A25 SCLCR/L 09	○	○	25	23	17	32	CC.T 09T3..	4015-M3.5x12	AACN-2-0001	AAV-08-M3.5x8	80-T15
ATTC-A32 SCLCR/L 09	○	○	32	32	22	40				AAV-07-M4.5x13	
ATTC-A40 SCLCR/L 12	●	●	40	32	27	50		1020-M4.5x16		AACN-2-0003	

R: Sağ / Right / Правый L: Sol / Left / Левый
● Stokta / In Stock / В наличии ○ Stokta Yok / Non Stock Item / Нет в наличии

Sipariş Örneği/Ordering Example/Образец заказа
1 ad./pcs./шт. ATTC-A16-SDUCR 07



KAPR=93°

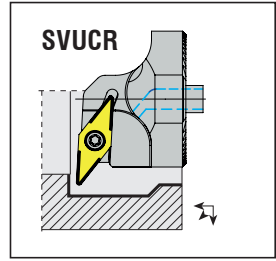
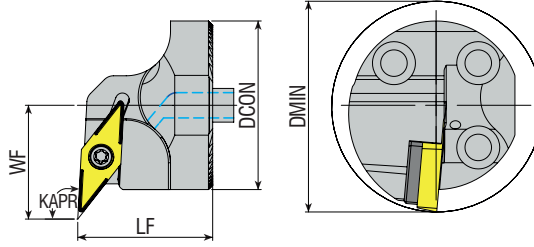

Takım Kodu
Ordering Code
Код для заказа

Stok Stock Наличие	TAKIM ÖLÇÜLERİ (MM) DIMENSION (MM) РАЗМЕРЫ (MM)					Kesici Uç Insert Пластина	Yedek Parçaları / Spare Parts / Запасные части				
	R	L	DCON	LF	WF		DMIN	SIKMA VIDASI SCREW ЗАЖИМНОЙ ВИНТ	Altlık Shim Отпорная пластина	Altlık Vidası Shim Screw Винт отпорной пластины	Tork Anahtar Torx Key Торх Ключ
ATTC-A20 SVUCR/L 11	○	○	20	20	15	27	VC.T 1103..	4008-M2.5x6	-	-	80-T08
ATTC-A25 SVUCR/L 11	○	○	25	23	17	32					
ATTC-A32 SVUCR/L 16	○	○	32	32	22	40	VC.T 1604..	4015-M3.5x14	AAVN-2-0002	AAV-06-M3.5x11	80-T15
ATTC-A40 SVUCR/L 16	●	●	40	32	27	50					



KAPR=93°

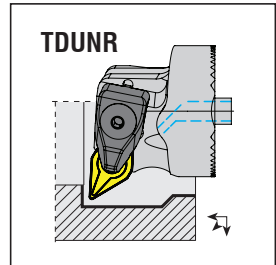
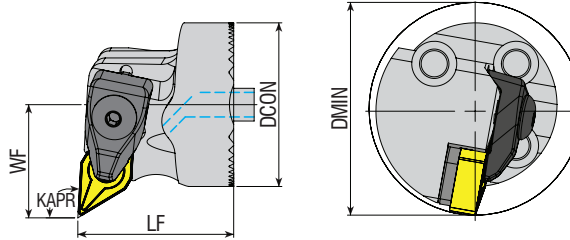

Takım Kodu
Ordering Code
Код для заказа

Stok Stock Наличие	Takım Ölçüleri (mm) Dimension (mm) Размеры (mm)					Kesici Uç Insert Пластина	Yedek Parçaları / Spare Parts / Запасные части							
	R	L	DCON	LF	WF		DMIN	Baskı Pabucu Wedge Clamp Прижим	Pabuç Vidası Clamp Screw Зажимной винт	Altlık Shim Отпорная пластина	Altlık Vidası Shim Screw Винт отпорной пластины	Sekman Ring Кольцо	Pu Stamp Шайба	Anahtar Allen Key Ключ
ATTC-A32 TDUNR/L 11	○	○	32	32	22	40	DNM. 1104..	ATK-01	AKV-01-M5x22	AADN -2-0001	AAV-04-M5x12	AS-01	ABPL-01	AAL-03-3
ATTC-A40 TDUNR/L 15	●	●	40	38	27	50	DNM. 1506..	ATK-02	AKV-30-M6x22	AADN -3-0001	AAV-02-M5x12			

R: Sağ / Right / Правый L: Sol / Left / Левый

● Stokta / In Stock / В наличии ○ Stokta Yok / Non Stock Item / Нет в наличии

Sipariş Örneği/Ordering Example/Образец заказа

1 Ad./Pcs./шт. ATTC-A20 SVUCR 11

TIRLAMAZ TAKIMLARIN KARTUŞLARI
ANTI VIBRATION TOOLS CARTRIDGES
 КАРТРИДЖИ ДЛЯ АНТИВИБРАЦИОННОЙ РАСТОЧНОЙ ДЕРЖАВКИ



KAPR=95°

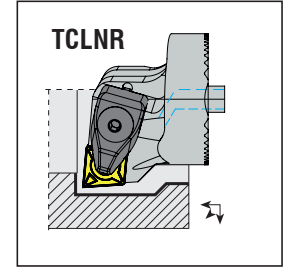
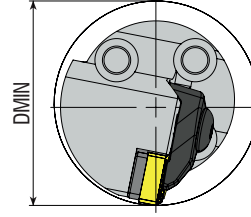
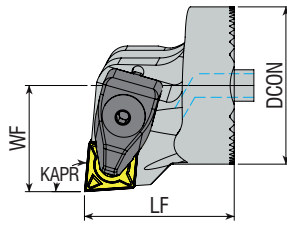

Takım Kodu Ordering Code Код для заказа	Stok Stock Наличие		Takım Ölçüleri (mm) Dimension (mm) Размеры (мм)				Kesici Uç Insert Пластина	Yedek Parçaları / Spare Parts / Запасные части						
	R	L	DCON	LF	WF	DMIN		Baskı Pabucu Wedge Clamp Прижим	Pabuç Vidası Clamp Screw Зажимной винт	Aitlik Shim Опорная пластина	Aitlik Vidası Shim Screw Винт опорной пластины	Sekman Ring Кольцо	Pul Stamp Шайба	Anahtar Allen Key Ключ
ATTC-A32 TCLNR/L 12	○	○	32	32	22	40	CNM. 1204..							
ATTC-A40 TCLNR/L 12	●	●	40	38	27	50								

TIRLAMAZ TAKIMLARIN MERKEZLEME APARATI
ANTI VIBRATION TOOLS CENTERING INSTRUMENT
 НАСАДКА ДЛЯ КАЛИБРОВАНИЯ КАРТРИДЖА АНТИВИБРАЦИОННОГО РЕЗЦА

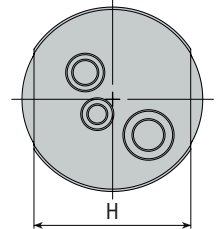
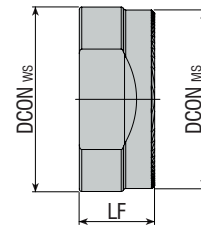

Takım Kodu Ordering Code Код для заказа	Stok Stock Наличие	Takım Ölçüleri (mm) Dimension (mm) Размеры (мм)				Gövde Tipi Boring Bars Борштанги
		DCONWS	DCONMS	LF	H	
ATTC-16-25	●	28	25	15	22	ATTB-D16/D20/D25 ATTB-D32/D40/D50/D60
ATTC-32-60	●	53	40	20	35	

R: Sağ / Right / Правый L: Sol / Left / Левый
 ● Stokta / In Stock / В наличии ○ Stokta Yok / Non Stock Item / Нет в наличии

Sipariş Örneği/Ordering Example/Образец заказа
 1 ad./pcs./шт. ATTC-A32 TCLNR 12

1 Montaj ve Ayarlama | Assembly and Adjusting | Сборка и установка

Kartuş ve gövdenin montaj edilecek yüzeyleri, tutucunun iç kısmı temizlenmelidir. Aşağıdaki görselde A ve B konumlarına bakın.

The surface of the cartridge and the shank to be mounted, as well as the inner part of the toolholder should be cleaned. Check A and B in the image below.

Посадочные поверхности борштанги (А) и резцовой головки (В) должны быть очищены перед сборкой.

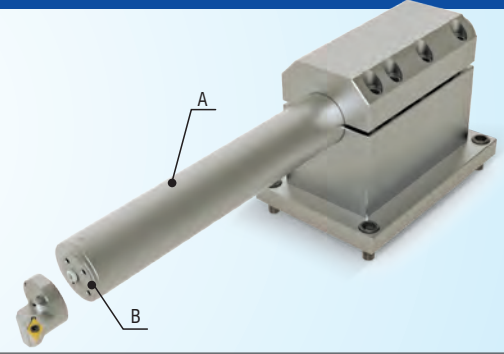

2 Gövde Montajı | Assembly for the Shank | Резцедержатель

Bağlama uzunluğu 4 L / D oranından az olmamalıdır. Tutucunun üst kısmını çıkartma yöntemiyle veya diğer tutma sıkma yöntemleriyle kullanmanızı öneririz (C tipi). Vidalı bağlama yöntemi kullanmayın. Uzun süre çalışırken lütfen içten soğutmayı kullanın.

The clamping length should not be less than 4 L/D ratio. Suggest using the clamping cover with opening method and other holding clamping methods. (Type C). Do not use screw clamping method. Use inner cooling please when working a long time.

Длина закрепления не менее 4 диаметров хвостовика. Резцедержатель должен обеспечивать большую площадь обхвата и concentricность (тип С). Закрепление борштанг винтом не допускается. Используйте внутренний подвод СОЖ непрерывно во время работы, а так же некоторое время до начала работы

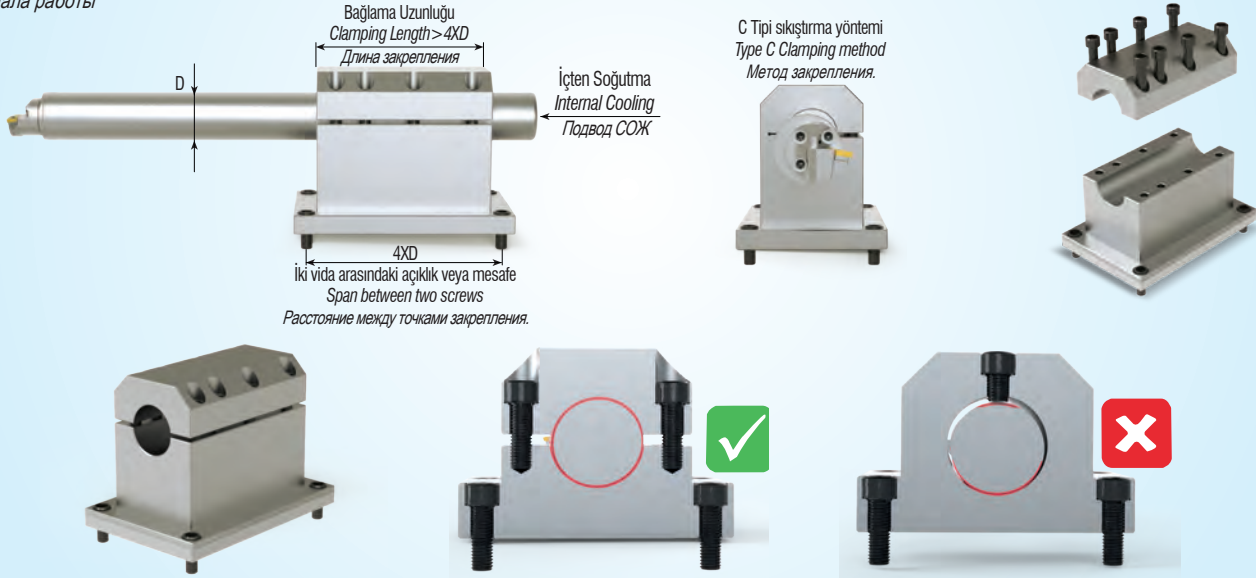

3 Merkez Yüksekliğinin Ayarlanması | Adjusting the Height of Centre Assembly | Установка высоты центра

Gövdeyi ilk kez montaj ederken merkez yüksekliği için özel kalibrasyon aparatı kullanılmalıdır. Önce gövdeyi tutucuya monte edin, ardından X ekseninde 0,01 tolerans içinde kalibre edin. Lütfen komparatör saati ile ayarlamayı yapın.

When mounting the body for the first time, a special calibration tool should be used for the center height. First mount the shank on the holder, then calibrate it within 0.01 tolerance on the X axis direction. Please make the adjustment with the dial indicator device.

Для большей жёсткости борштанги изготавливают с цилиндрическим хвостовиком. После монтажа борштанги её необходимо откалибровать. Установите насадку для калибрования картриджа и с помощью индикатора часового типа проконтролируйте точность установки вдоль оси "X" (необходимо добиться погрешность в пределах 10 мкм).

Kalibrasyon Yüzeyi
Calibrating end face
Плоская поверхность
для калибровки.

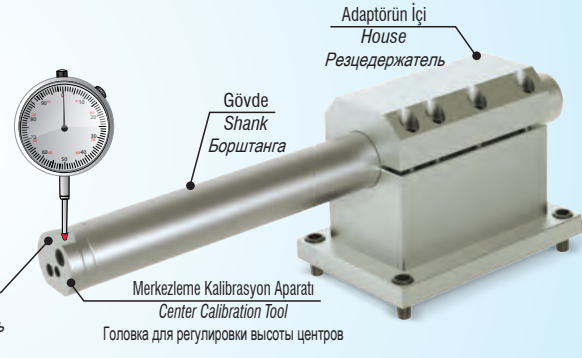

4 Doğru Kartuş Montajı | Assembly the Right Cartridge | Сборка

Yandaki şekle bakın:
See the figure on the side:
Смотри рисунок сбоку

Sol Yön Takım
Left Hand
Левое исполнение



Sağ Yön Takım
Right Hand
Правое исполнение



Doğru Uç Seçimi / Choosing the Correct Insert / Рекомендации по подбору твердосплавных пластин

Doğru kesici ucun seçilmesi, titreşim sönümlemenin genel başarısı üzerinde büyük bir etkiye sahiptir. Kesici ucun işleme stabilitesini artırabilmesinin ana yolu kesme kuvvetlerini en aza indirmektir. Titreşimleri ortadan kaldırmak için aşağıdaki adımlara uymanız gerekir: Mümkünse, her zaman kısa takımları kullanın. Aksi takdirde, titreşimi en aza indirmek için hızlarınızı azaltın.

Choosing the correct insert can have a big influence on the overall success of vibration damping. The main way the insert can improve the machining stability is by minimizing the cutting forces. Following the guidelines below should be your first step to eliminate vibrations: If possible, use it always short drilling tools. Otherwise, reduce your speeds to minimize vibration.

Правильный подбор твердосплавной пластины может оказать большое влияние на снижение вибрации. Основной задачей для стабильной обработки является снижение усилий резания, а это зависит от правильного выбора пластины. Следуя приведенным ниже рекомендациям, Вы можете снизить вибрации во время обработки. Если есть возможность, всегда используйте инструмент как можно меньшей длины. В противном случае уменьшите скорость, чтобы минимизировать вибрацию.

A Radyal kuvvetleri minimuma indirmek için mümkün olduğunca 90°'ye yakın bir giriş açılı takımı seçin.

Choose an entry angle that is as close as possible to 90° to reduce the radial forces to a minimum.

Выбирайте угол в плане (KAPR) близкий к 90° - в этом случае радиальная сила резания будет ниже.

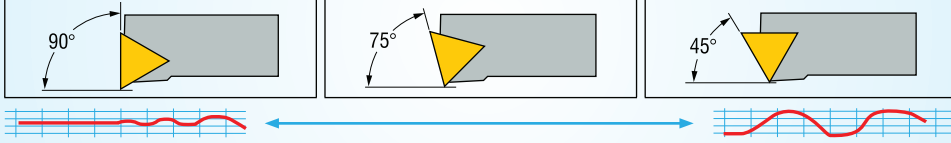
**B** Mümkün olan en küçük kesici uç açısını seçin. Böylece kesme kuvvetleri azalacak ve yüzey kalitesi artacak.

Choose the smallest insert head angle possible. This will reduce overall cutting forces and increase the clearance.

Склонность к вибрациям растёт слева направо. С увеличением угла при вершине пластины увеличивается усилие резания.

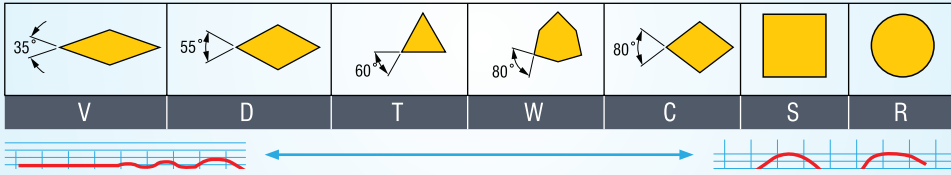
**C** Titreşimi azaltmak için olabildiğince en küçük radyüslü ucu seçmelisiniz.

Choose a small nose radius to reduce the cutting forces and to enable machining in a lower depth of cut.

Меньший угол при вершине позволит снизить усилие резания, за счёт малых глубин резания и подачи.

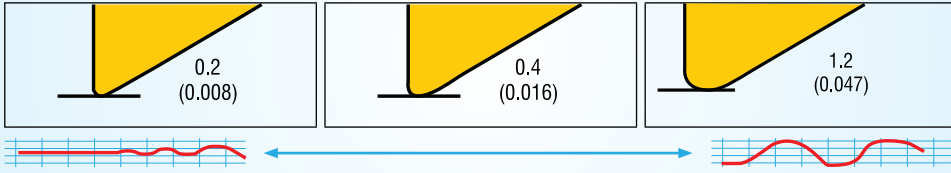
**D** İşleme derinliği (ap) radyüsten daha büyük olmalıdır.

Machining depth (ap) should be larger than the nose radius.

Глубина резания должна превышать радиус при вершине.

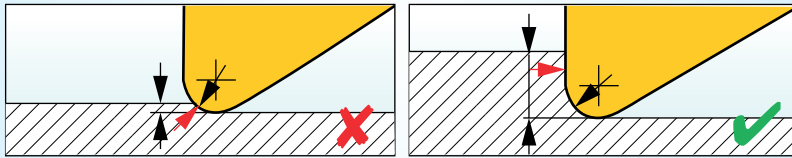
**E** Kesme kuvvetlerini azaltmak için daha pozitif geometriye sahip bir kesici uç kullanın.

Use an insert with an overall positive geometry to reduce the cutting forces:

Используйте пластины с задними углами, что бы снизить силы резания.

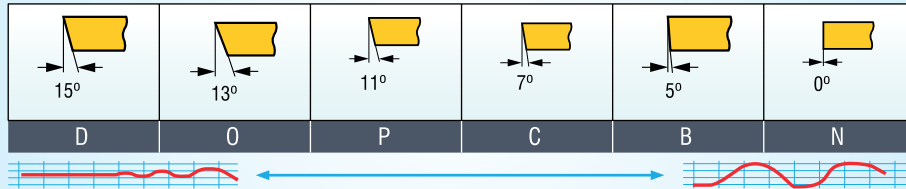
**F** Pozitif bir üst eğim geometrisi seçin:

Choose a positive top rake geometry:

Выбирайте "стружколомы" (формы передней поверхности СМП) с большей величиной переднего угла.

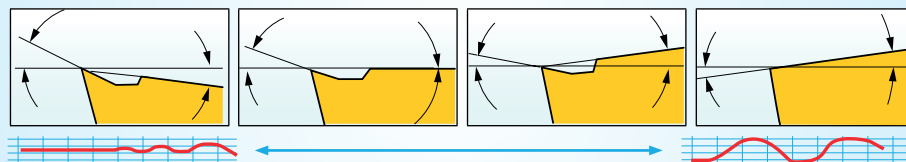
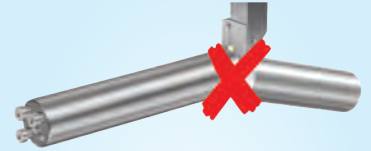
**G** For-dampened-straight-adaptor:

L, kesildikten sonra min uzunluk

L, min length after cut off

L, минимальная длина после отрезания

Ø	Kısa Tasarım Short Design Краткий дизайн 4-7x Ø (mm)	Uzun Tasarım Long Design Длинный дизайн 7-10x Ø (mm)
16	100	155
20	125	200
25	155	255
32	190	320
40	240	410
50	305	520
60	380	630



konusulan
the spoken kalite...
quality...

KARTUŞLAR

KARTUŞLAR
CARTRIDGE
КАРТРИДЖИ



S

1

T

2

F

3

C

4

R

5

12

6

C

7

A

8

16

9

1 Sıkma Tipi / Method of Mounting of Insert / Способ крепления пластины



Deliksiz Üstten Sıkma
Top Clamping Without Hole
Прижим сверху без отверстия

C



Delikten Levye ile Sıkma
Hole Clamping (Lever Lock)
Прижим рычагом за отверстие

P



Vida ile Sıkma
Screw on Clamping
Крепление винтом

S

2 Uç Tipi / Type of Insert / Форма пластины



C



S



T

3 Yanaşma Açısı / Tool Holder Shape Bar Geometry / Угол в плане

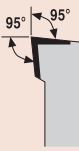

L

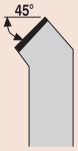

S

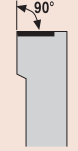

F



R

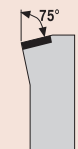

K

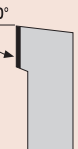

G



W

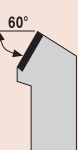

T

4 Serbest Uç Açısı / Insert Clearance Angle / Задний угол пластины



C



P



N

5 Kesme Yönü / Cutting Direction / Направление резания

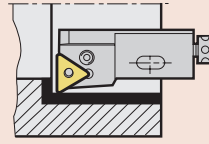

R

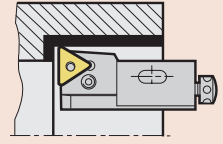

L

6 Kesme Kenar Yüksekliği / Cutting Edge Height / Высота режущей кромки

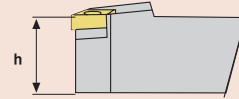

7 Kartuş Kodu / Cartridge Code / Код картриджа

C
(Kartuş / Cartridge Code / Код картриджа)

8 Kartuş Tipi / Cartridge Type / Тип картриджа

A
(ISO 5611)

9 Kesme Kenar Uzunluğu / Cutting Edge Length / Длина режущей кромки



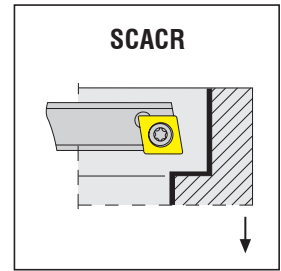
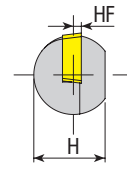
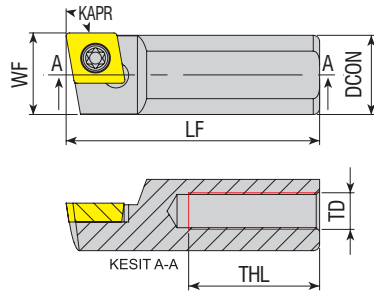

Takım Kodu Ordering Code Код для заказа	Stok Stock Наличие		Takım Ölçüleri (mm) Dimension (mm) Размеры (мм)							Kesici Uç Insert Пластина	Yedek Parçaları / Spare Parts / Запасные части		
	R	L	DCON	H	LF	THL	HF	WF	TD		Sıkma Vidası Screw Зажимной винт	Tork Anahtar Torx Key Торх Ключ	
S10X SCACR/L 06	●	●	10	9	25	10	1	10.3	M5x0.8	CC.T 0602..	4008-M2.5x6	80-T08	
S10A SCACR/L 06	●	●	10	9	32	15	1	10.3	M5x0.8				
S1018 SCACR/L 06	○	●	10	9	18	8	1	9.8	M5x0.8				
S1065 SCACR/L 06	○	●	10	9	65	25	1	10.3	M5x0.8				
S10C SCACR/L 06	●	●	10	9	50	25	1	10.3	M5x0.8				
S12B SCACR/L 06	●	●	12	11	40	25	1	12.3	M5x0.8				
S12D SCACR/L 06	●	●	12	11	60	25	1	12.3	M5x0.8	CC.T 09T3..	4015-M3.5x8	80-T15	
S12D SCACR/L 09	●	●	12	11	60	25	2	12.2	M5x0.8				
S1265 SCACR/L 09	○	●	12	11	65	25	2	12.3	M5x0.8				
S12H SCACR/L 09	●	●	12	11	100	25	2	12.2	M5x0.8				
S15C SCACR/L 09	●	●	15	14	50	25	2	15.3	M8x1.25				
S1554 SCACR/L 09	○	●	15	14	54	25	2	15.3	M8x1.25				
S15E SCACR/L 09	○	●	15	14	70	45	2	15.3	M8x1.25				
S15D SCACR/L 09	○	●	15	14	60	30	2	15.3	M8x1.25				
S16A SCACR/L 09	●	●	16	15	32	15	2	16.5	M6x1				
S16B SCACR/L 09	●	●	16	15	40	20	2	16.5	M6x1				
S16C SCACR/L 09	○	●	16	15	50	25	2	16.5	M6x1				
S16D SCACR/L 09	●	●	16	15	60	30	2	16.5	M6x1				
S16E SCACR/L 09	○	●	16	15	70	30	2	16.5	M6x1				
S16G SCACR/L 09	●	●	16	15	90	30	2	16.5	M6x1				
S16H SCACR/L 09	○	●	16	15	100	35	4	16.5	M6x1				
S1868 SCACR/L 09	○	●	18	17	68	30	2	18.5	M8x1.25				
S18E SCACR/L 09	●	●	18	17	70	30	2	18.5	M8x1.25				
S1888 SCACR/L 09	○	●	18	17	88	30	2	18.5	M8x1.25				
S18105 SCACR/L 09	○	●	18	17	105	30	2	18.5	M8x1.25				
S18175 SCACR/L 09	○	●	18	17	175	30	2	18.5	M8x1.25				
S20E SCACR/L 09	●	●	20	18.3	70	30	2	20.5	M6x1	CC.T 1204..	1020-M5x11	80-T20	
S20E SCACR/L 12	●	●	20	18.3	70	30	2	20.5	M6x1				
S20H SCACR/L 12	●	●	20	18.3	100	30	2	20.5	M6x1				

R: Sağ / Right / Правый L: Sol / Left / Левый
● Stokta / In Stock / В наличии ○ Stokta Yok / Non Stock Item / Нет в наличии

Sipariş Örneği/Ordering Example/Образец заказа
1 ad./pcs./шт. S10X SCACR 06

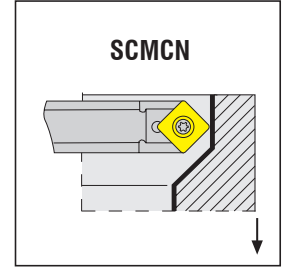
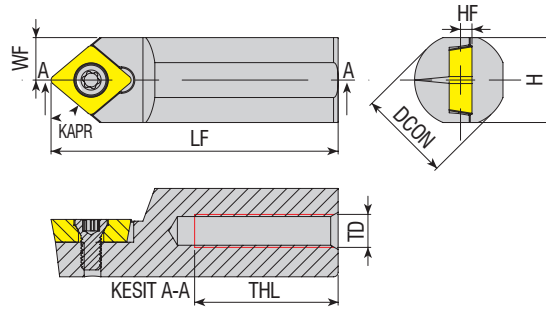

Takım Kodu Ordering Code Код для заказа	Stok Stock Наличие	Takım Ölçüleri (mm) Dimension (mm) Размеры (мм)							Kesici Uç Insert Пластина	Yedek Parçaları / Spare Parts / Запасные части		
		DCON	H	LF	THL	HF	WF	TD		Sıkma Vidası Screw Зажимной винт	Tork Anahtar Torx Key Торх Ключ	
S10X SCMCN 06	●	10	9	25	10	1	5	M5x0.8	CC.T 0602..	4008-M2.5x6	80-T08	
S12D SCMCN 06	●	12	11	60	25	1	6	M5x0.8				
S16C SCMCN 09	●	16	15	50	25	2	8	M6x1	CC.T 09T3..	4015-M3.5x11	80-T15	
S16D SCMCN 09	●	16	15	60	25	4	8	M6x1				

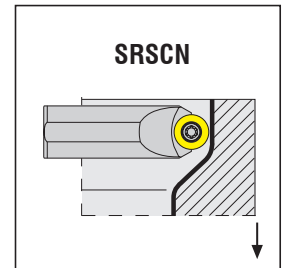
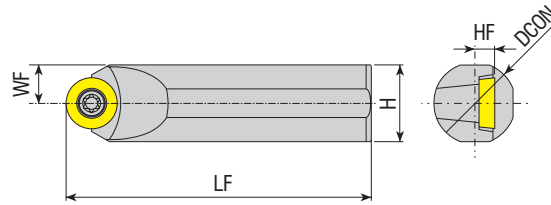

Takım Kodu Ordering Code Код для заказа	Stok Stock Наличие	Takım Ölçüleri (mm) Dimension (mm) Размеры (мм)					Kesici Uç Insert Пластина	Yedek Parçaları / Spare Parts / Запасные части		
		DCON	H	WF	HF	LF		Sıkma Vidası Screw Зажимной винт	Tork Anahtar Torx Key Торх Ключ	
S12D SRSCN 10	●	12	11	6	3.9	60	RC.. 10T3..	4015-M3.5x9	80-T15	
S14D SRSCN 10	●	14	13	7	3.9	60		4015-M3.5x11		
S16D SRSCN 10	●	16	15	8	3.9	60				

R: Sağ / Right / Правый L: Sol / Left / Левый
● Stokta / In Stock / В наличии ○ Stokta Yok / Non Stock Item / Нет в наличии

Sipariş Örneği/Ordering Example/Образец заказа
1 ad./pcs./шт. S10X SCMCN 06

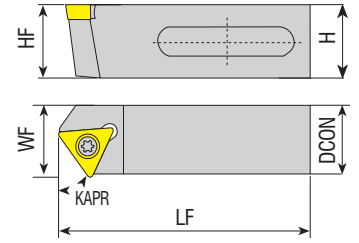

Takım Kodu Ordering Code Код для заказа	Stok Stock Наличие		Takım Ölçüleri (mm) Dimension (mm) Размеры (мм)					Kesici Uç Insert Пластина	Yedek Parçaları / Spare Parts / Запасные части		
	R	L	DCON	H	HF	LF	WF		Sıkma Vidası Screw Зажимной винт	Tork Anahtar Torx Key Торх Ключ	
STXCR/L 2020 B16	○	●	20	20	20	45	20	TC.. 16T3..	4015-M3.5x11	80-T15	
STXCR/L 2020 E16	○	●	20	20	20	70	20				
STXCR/L 2020 B16-SA	○	●	20	10	20	45	20				
STXCR/L 2020 E16-SA	○	●	20	10	20	70	20				
STXCR/L 2020 B16-PL	○	●	20	10	20	45	20				
STXCR/L 2020 E16-PL	○	●	20	10	20	70	20				
STXCR/L 2020 H16-PL	○	●	20	10	20	100	20				

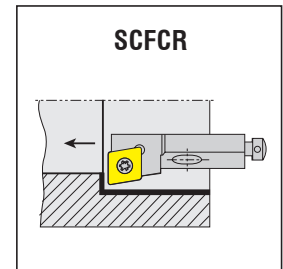
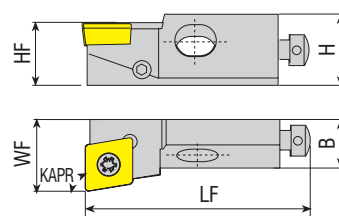
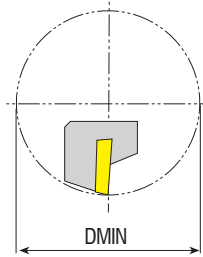

Takım Kodu Ordering Code Код для заказа	Stok Stock Наличие		Takım Ölçüleri (mm) Dimension (mm) Размеры (мм)						Kesici Uç Insert Пластина	Yedek Parçaları / Spare Parts / Запасные части			
	R	L	HF	H	B	LF	WF	DMIN		Altlık Shim Опорная пластина	Altlık Vidası Shim Screw Винт опорной пластины	Sıkma Vidası Screw Зажимной винт	Tork Anahtar Torx Key Торх Ключ
SCFCR/L 06CA 06	●	●	6	8.5	6	25	8	≥20	CC.T 060204	-	-	4008-M2.5x6	80-T08
SCFCR/L 08CA 06	●	●	8	11	8	32	10	≥25					
SCFCR/L 10CA 09	●	●	10	15	11	50	14	≥40					
SCFCR/L 12CA 12	●	○	12	20	15	55	20	≥50					
SCFCR/L 16CA 12	●	●	16	21	20	63	25	≥60	CC.T 120408	AAVN-2-0003	AAV-10-M4.5x8	4020-M4.5x12	80-T20

R: Sağ / Right / Правый L: Sol / Left / Левый
● Stokta / In Stock / В наличии ○ Stokta Yok / Non Stock Item / Нет в наличии

Sipariş Örneği/Ordering Example/Образец заказа
1 ad./pcs./шт. STXCR 2020 B16

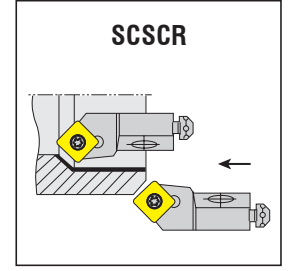
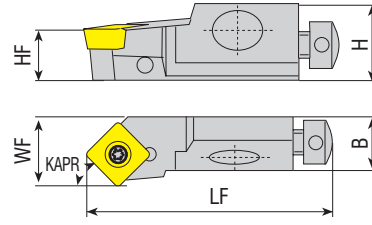
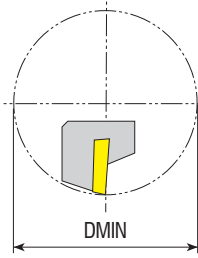

Takım Kodu Ordering Code Код для заказа	Stok Stock Наличие		Takım Ölçüleri (mm) Dimension (mm) Размеры (мм)						Kesici Uç Insert Пластина	Yedek Parçaları / Spare Parts / Запасные части			
	R	L	HF	H	B	LF	WF	DMIN		Altlık Shim Опорная пластина	Altlık Vidası Shim Screw Винт опорной пластины	Sıkma Vidası Screw Зажимной винт	Tork Anahtar Torx Key Торх Ключ
SCSCR/L 06CA 06	●	○	6	8	6	30	8	≥20		-	-	4008-M2.5x6	80-T08
SCSCR/L 10CA 09	●	○	10	15	11	50	14	≥40		-	-	4015-M3.5x9	80-T15
SCSCR/L 12CA 12	○	○	12	20	15	55	20	≥50		-	-	1020-M5x11	80-T20

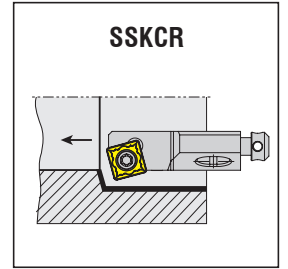
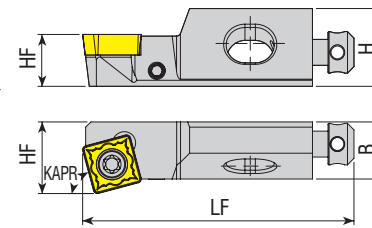
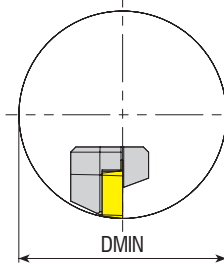

Takım Kodu Ordering Code Код для заказа	Stok Stock Наличие		Takım Ölçüleri (mm) Dimension (mm) Размеры (мм)						Kesici Uç Insert Пластина	Yedek Parçaları / Spare Parts / Запасные части			
	R	L	HF	H	B	LF	WF	DMIN		Altlık Shim Опорная пластина	Altlık Vidası Shim Screw Винт опорной пластины	Sıkma Vidası Screw Зажимной винт	Tork Anahtar Torx Key Торх Ключ
SSKCR/L 10CA 09	●	○	10	15	11	50	14	≥40		-	-	4015-M3.5x9	80-T15
SSKCR/L 12CA 12	●	○	12	20	15	55	20	≥50		-	-	1020-M5x11	80-T20

R: Sağ / Right / Правый L: Sol / Left / Левый
● Stokta / In Stock / В наличии ○ Stokta Yok / Non Stock Item / Нет в наличии

Sipariş Örneği/Ordering Example/Образец заказа
1 ad./pcs./шт. SCSCR 06CA 06

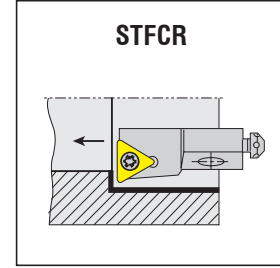
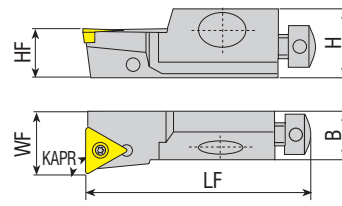
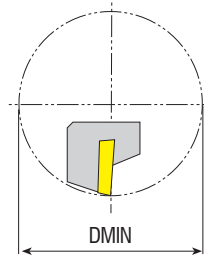

Takım Kodu Ordering Code Код для заказа	Stok Stock Наличие		Takım Ölçüleri (mm) Dimension (mm) Размеры (мм)						Kesici Uç Insert Пластина	Yedek Parçaları / Spare Parts / Запасные части			
	R	L	HF	H	B	LF	WF	DMIN		Altık Shim Опорная пластина	Altık Vidası Shim Screw Винт опорной пластины	Sıkma Vidası Screw Зажимной винт	Tork Anahtar Torx Key Торх Ключ
STFCR/L 08CA 09	●	●	8	11	8	32	10	≥25	TC.T 090204	-	-	3007-M2.2x5	80-T07
STFCR/L 10CA 11	●	●	10	15	11	50	14	≥40	TC.T 110204	-	-	4008-M2.5x6	80-T08
STFCR/L 12CA 16	●	○	12	20	15	55	20	≥50	TC.T 16T308	-	-	4015-M3.5x11	80-T15
STFCR/L 16CA 16	●	●	16	21	20	63	25	≥60		AATN-2-0001	AAV-06-M3.5x11	4015-M3.5x14	

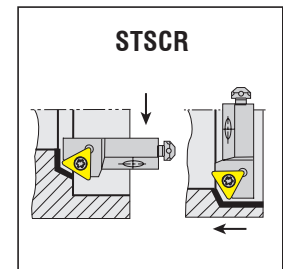
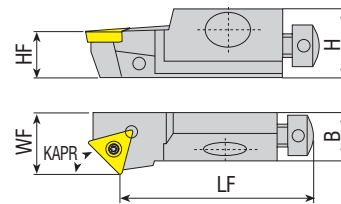
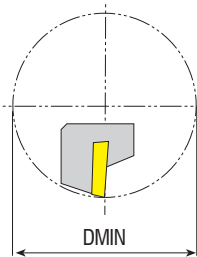

Takım Kodu Ordering Code Код для заказа	Stok Stock Наличие		Takım Ölçüleri (mm) Dimension (mm) Размеры (мм)						Kesici Uç Insert Пластина	Yedek Parçaları / Spare Parts / Запасные части			
	R	L	HF	H	B	LF	WF	DMIN		Altık Shim Опорная пластина	Altık Vidası Shim Screw Винт опорной пластины	Sıkma Vidası Screw Зажимной винт	Tork Anahtar Torx Key Торх Ключ
STSCR/L 08CA 09	●	○	8	11	8	28	10	≥25	TC.T 090204	-	-	3007-M2.2x5	80-T07
STSCR/L 10CA 11	●	●	10	15	11	44	14	≥40	TC.T 110204	-	-	4008-M2.5x6	80-T08
STSCR/L 12CA 16	●	○	12	20	15	47	20	≥50	TC.T 16T308	-	-	4015-M3.5x11	80-T15

R: Sağ / Right / Правый L: Sol / Left / Левый
● Stokta / In Stock / В наличии ○ Stokta Yok / Non Stock Item / Нет в наличии

Sipariş Örneği/Ordering Example/Образец заказа
1 ad./pcs./шт. STFCR 08CA 09

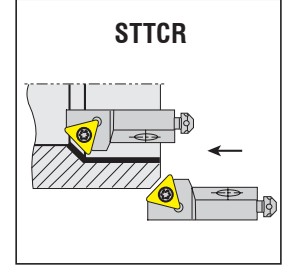
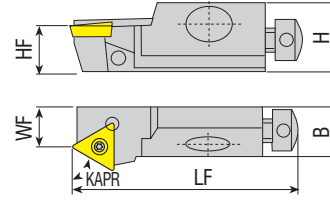
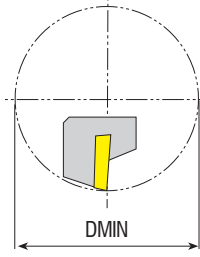

Takım Kodu Ordering Code Код для заказа	Stok Stock Наличие		Takım Ölçüleri (mm) Dimension (mm) Размеры (мм)					Kesici Uç Insert Пластина	Yedek Parçaları / Spare Parts / Запасные части				
	R	L	HF	H	B	LF	WF		DMIN	Altık Shim Опорная пластина	Altık Vidası Shim Screw Винт опорной пластины	Sıkma Vidası Screw Зажимной винт	Tork Anahtar Torx Key Торх Ключ
STTCR/L 08CA 09	●	●	8	11	8	32	6	≥25	TC.T 090204	-	-	3007-M2.2x5	80-T07
STTCR/L 10CA 11	●	●	10	15	11	50	9	≥40	TC.T 110204	-	-	4008-M2.5x6	80-T08

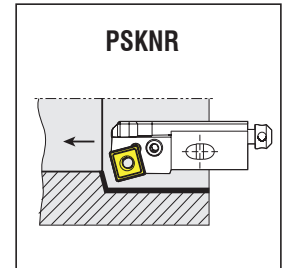
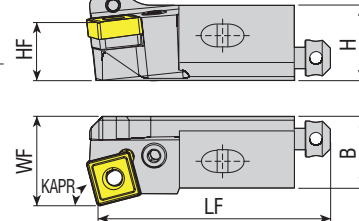
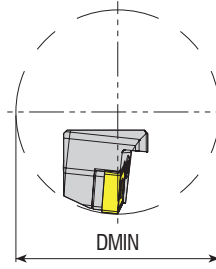

Takım Kodu Ordering Code Код для заказа	Stok Stock Наличие		Takım Ölçüleri (mm) Dimension (mm) Размеры (мм)					Kesici Uç Insert Пластина	Yedek Parçaları / Spare Parts / Запасные части					
	R	L	HF	H	B	LF	WF		DMIN	Levye Lever Рычаг	Levye Vidası Lever Screw Винт рычага	Altık Shim Опорная пластина	Altık Yayı Shim Spring Втулка рычага	Anahtar Allen Key Ключ
PSKNR/L 16CA 12	●	●	16	21	20	63	25	≥60	SNM.120408	APL-02	ALV-08-M8x16	AASN-3-0004	AAV-02	AAL-02-2.5

R: Sağ / Right / Правый L: Sol / Left / Левый
● Stokta / In Stock / В наличии ○ Stokta Yok / Non Stock Item / Нет в наличии

Sipariş Örneği/Ordering Example/Образец заказа
1 ad./pcs./шт. STTCR 08CA 09

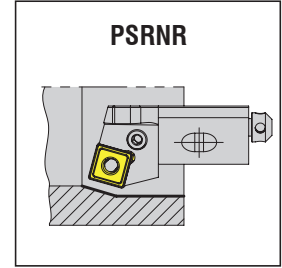
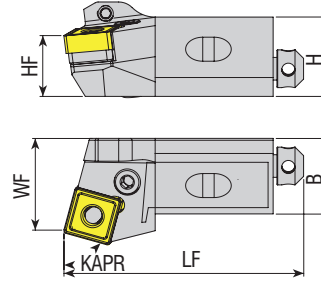
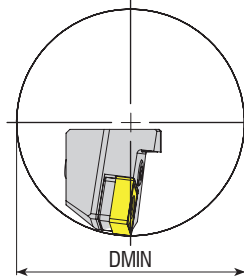

Takım Kodu
Ordering Code
Код для заказа

Stok Stock Наличие	Takım Ölçüleri (mm) Dimension (mm) Размеры (мм)								Kesici Uç Insert Пластина	Yedek Parçaları / Spare Parts / Запасные части				
	R	L	HF	H	B	LF	WF	DMIN		Levyé Lever Рычаг	Levyé Vidası Lever Screw Винт рычага	Altlık Shim Опорная пластина	Altlık Yayı Shim Spring Втулка рычага	Anahtar Allen Key Ключ
○ ●			16	21	20	63	25	≥60						
PSRNR/L 16CA 12	○	●	16	21	20	63	25	≥60	SNM.120408	APL-02	ALV-03-M8x19	AASN-3-0004	AAY-02	AAL-03-3

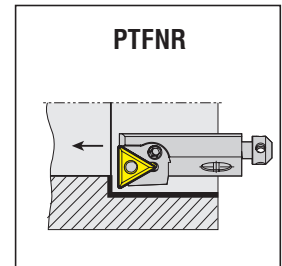
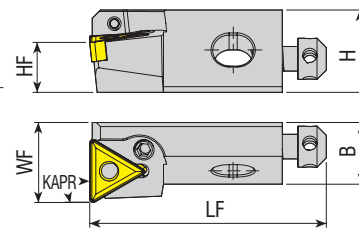
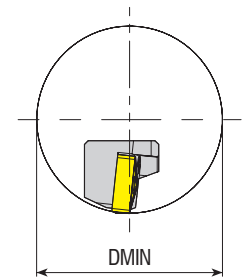

Takım Kodu
Ordering Code
Код для заказа

Stok Stock Наличие	Takım Ölçüleri (mm) Dimension (mm) Размеры (мм)								Kesici Uç Insert Пластина	Yedek Parçaları / Spare Parts / Запасные части				
	R	L	HF	H	B	LF	WF	DMIN		Levyé Lever Рычаг	Levyé Vidası Lever Screw Винт рычага	Altlık Shim Опорная пластина	Altlık Yayı Shim Spring Втулка рычага	Anahtar Allen Key Ключ
● ●	●	●	12	20	15	47	20	≥50						
PTFNR/L 12CA 16	●	●	12	20	15	47	20	≥50	TNM.160408	APL-08	ALV-07-M6x13	-	AAY-07	AAL-02-2.5
PTFNR/L 16CA 16	●	○	16	21	20	63	25	≥60		APL-01	ALV-01-M6x14	AATN-3-0025	AAY-01	

R: Sağ / Right / Правый L: Sol / Left / Левый

● Stokta / In Stock / В наличии ○ Stokta Yok / Non Stock Item / Нет в наличии

Sipariş Örneği/Ordering Example/Образец заказа
1 ad./pcs./шт. PSRNR 16CA 12

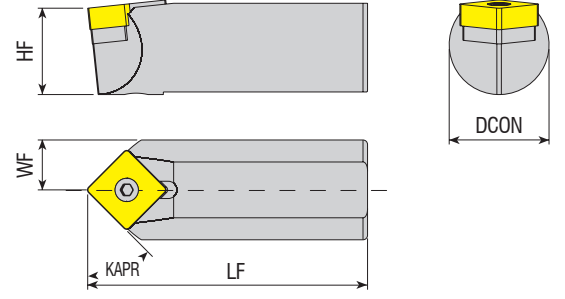

Takım Kodu Ordering Code Код для заказа	Stok Stock Наличие	Takım Ölçüleri (mm) Dimension (mm) Размеры (мм)				Kesici Uç Insert Пластина	Yedek Parçaları / Spare Parts / Запасные части				
		DCON	HF	LF	WF		Altlık Shim Опорная пластина	Sıkma Vidası Screw Зажимной винт	Baskı Parçası Wedge Clamp Прижим	Baskı Vidası Clamp Screw Зажимной винт	Tork Anahtar Torx Key Торх Ключ
S22D PSDNN 12C	●	22	19.5	65	11						
						SNM. 1204..	AASN-20020	AEV-01-M6x16	ACK-05	4015-M4x11	AAL-02-2.5

R: Sağ / Right / Правый L: Sol / Left / Левый

● Stokta / In Stock / В наличии ○ Stokta Yok / Non Stock Item / Нет в наличии

Sipariş Örneği/Ordering Example/Образец заказа
1 ad./pcs./шт. S22D PSDNN 12C

KARTUŞLARIN YEDEK PARÇALARI
SPARE PARTS OF CARTRIDGE
ЗАПАСНЫЕ ЧАСТИ К КАРТРИДЖАМ

Takım Kodu Ordering Code Код для заказа	Yedek Parçaları / Spare Parts / Запасные части					
	Eksenel Ayar Vida Axial Adj. Screw Осевой регулировочный винт	Radyal Ayar Vida Radial Adj. Screw Радиальный регулировочный винт	Radyal Ayar Vida Anahtar Radial Adj. Screw Allen Key Шестигранный ключ для крепления радиального винта	Montaj Vida Mounting Screw Монтажный винт	Montaj Vida Anahtar Mounting Screw Allen Key Монтажный винт оголовкой под шестигранник	
SCFCR/L	06CA 06	2600-M4x9.5	2715-M3x5	AAL-09-1.5	AKV-23-M4x10	AAL-03-3
SCSCR/L	08CA 06	2600-M4x9.5	2715-M3x5	AAL-09-1.5	AKV-23-M4x10	AAL-03-3
SSKCR/L	10CA 09	2600-M5x13	2702-M4x10	AAL-01-2	2505-M6x16	AAL-03-3
	12CA 12	2600-M5x13	2702-M4x10	AAL-01-2	2505-M6x16	AAL-03-3
	16CA 12	2600-M6x18	2725-M5x12	AAL-02-2.5	2005-M8x25	AAL-07-5
STSCR/L	08CA 09	2600-M4x9.5	2715-M3x5	AAL-09-1.5	AKV-23-M4x10	AAL-03-3
STTCR/L	10CA 11	2600-M5x13	2702-M4x10	AAL-01-2	2505-M6x16	AAL-03-3
STFCR/L	12CA 16	2600-M5x13	2702-M4x10	AAL-01-2	2505-M6x16	AAL-03-3
	16CA 16	2600-M6x18	2725-M5x12	AAL-02-2.5	2005-M8x25	AAL-07-5
PTFNR/L	12CA 16	2600-M5x13	2702-M4x4	AAL-01-2	2505-M6x16	AAL-03-3
PSKNR/L	16CA 16	2600-M6x18	2725-M5x6	AAL-02-2.5	2005-M8x25	AAL-07-5
PSRNR/L	16CA 12	2600-M6x18	2725-M5x6	AAL-02-2.5	2005-M8x25	AAL-07-5



Takım Kodu Ordering Code Код для заказа	Stok Stock Наличие	Ölçü Aralığı (mm) Boring Range (mm) Диапазон растачивание (мм)					Kartuşlar Cartridge Картриджи	Gövde Takım Kodu Body Tool Code Код головки	Teknik Çizim Technical Draw Технический эскиз
		D max		D min		Max (D dış-D iç) (D out-D in)			
		D iç D in	D dış D out	D iç D in	D dış D out				
ACPBT-1	●	27-52	52	18-36	36	27	ÖTG-K-120-20		
ACPBT-2	●	27-49	52	25-36	36	27			
ACPBT-3	●	48-75	75	41	42	27			
ACPBT-4	●	51-75	75	51	52	27			
ACPBT-5	●	22-35	35	22	23	27			
ACPBT-6	●	15-35	35	15	16	27			
ACPBT-7	●	49-53	75	32-36	36	27			
ACPBT-8	●	49	75	33-37	37	27			

Takım Kodu Ordering Code Код для заказа	Stok Stock Наличие	Ölçü Aralığı (mm) Boring Range (mm) Диапазон растачивание (мм)					Kartuşlar Cartridge Картриджи	Gövde Takım Kodu Body Tool Code Код головки	Teknik Çizim Technical Draw Технический эскиз
		D1		D2		Max (D dış-D iç) (D out-D in)			
		D max	D min	D max	D min				
ACPBT-9	●	38	24	15	1	-	ÖTG-K-120-20		
ACPBT-10	●	78	64	43	29	-			

R: Sağ / Right / Правый L: Sol / Left / Левый

● Stokta / In Stock / В наличии ○ Stokta Yok / Non Stock Item / Нет в наличии

Sipariş Örneği / Ordering Example / Образец заказа

1 ad./pcs./шт. ACPBT-1



*konusulan
the spoken kalite...
quality...*

DİŞ AÇMA

DİŞ AÇMA TAKIMLARI
THREADING TOOLHOLDERS
РЕЗЬБОНАРЕЗНЫЕ ДЕРЖАВКИ





S **E** **R** **25 25** **M** **16** **C**

1 Sıkma Tipi / Method of Mounting of Insert
 Тип крепления пластины угла наклона пластины

S: Vida Sıkmalı
 S: Screw Clamping / S Крепление винтом
 T: Vida Sıkmalı Helis Açılı
 T: Screw Clamping with Helix Angle
 T: Крепление винтом с углом наклона винтовой линии

2 İşlem Tipi / Application
 Применение

E: Dış / External
 Нарезание для наружной резьбы
 I: İç / Internal /
 Для наружной резьбы

3 Kesme Yönü
 Cutting Direction
 Направление резания

R: Sağ Yan
 Right-Hand
 R: Правый
 L: Sol Yan
 Left-Hand
 L: Левый

4 Takım Malzemesi / Type of Boring / Сталь Инструмена

"A" Yüksek çelik gövde soğutma suyu kanallı / "A" Solid steel with coolant hole
 "A" Расточная державка из твердой стали с подвожом СОЖ
 "E" Çelik başlıkla sert metal gövde ve soğutma suyu kanallı / "E" Carbide bar with fixed steel head and coolant hole
 "E" Расточная державка из твердосплавного карбида с подвожом СОЖ
 "C" Karbür Şaft / "C" Carbide shank / "C" Расточная державка из твердосплавного карбида
 "S" Çelik Şaft / "S" Steel shank / "S" Расточная державка из твердой стали

4-5 Dış Çap Şaft Ölçüleri / External Shank Size
 Сечение державки

Şaft / Shank / Размеры : hxb
 2525 - 25 x 25 mm

5 Şaft Çapı / Shank Diameter
 Диаметр хвостовика

6 Şaft Boyu / Shank Length / Длина державки

A - 32	H - 100	Q - 180	x-special
B - 40	J - 110	R - 200	
C - 50	K - 125	S - 250	
D - 60	L - 140	T - 300	
E - 70	M - 150	U - 350	
F - 80	N - 160	V - 400	
G - 90	P - 170	W - 450	

7 Elmas Ölçüsü / Insert Size
 Размер пластины

l (mm)	d
06	5/32"
08	3/16"
11	1/4"
16	3/8"
22	1/2"
27	5/8"

8 Baskı Pabucu
 Wedge Clamp
 Прижим

S **I** **R** **S** **25** **R** **16** **C**

DIŞ ÇAP DIŞ AÇMA KATERLERİ
EXTERNAL THREADING TOOLHOLDERS
ДЕРЖАВКА ДЛЯ НАРЕЗАНИЯ НАРУЖНОЙ РЕЗЬБЫ

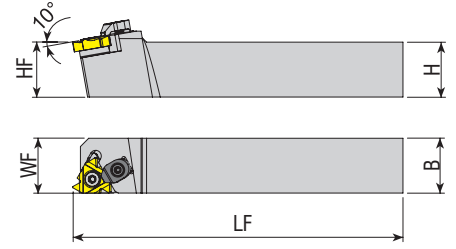
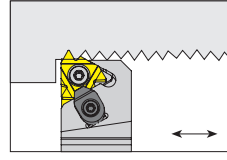

Takım Kodu Ordering Code Код для заказа	Stok Stock Наличие		Takım Ölçüleri (mm) Dimension (mm) Размеры (мм)				Kesici Uç Insert Пластина	Yedek Parçaları / Spare Parts / Запасные части					
	R	L	HF=H	B	LF	WF		Sıkma Vidası Screw Зажимной винт	Altlık Shim Опорная пластина	Altlık Vidası Shim Screw Винт опорной пластины	Baskı Parçası Wedge Clamp Прижим	Baskı Vidası Clamp Screw Зажимной винт	Tork Anahtar Torx Key Торх Ключ
SER/L 0808 E11	●	●	08	08	70	11	11 ER/EL	4008-M2.5x6	-	-	-	-	80-T08
SER/L 1010 E11	●	●	10	10	70	11							
SER/L 1212 F11	●	●	12	12	80	12							
SER/L 1616 H11	●	●	16	16	100	16							
SER/L 2020 H11	●	●	20	20	100	20							
SER/L 1616 H16C	●	●	16	16	100	16	16 ER/EL (0.35 - 3) ISO METRIC	4015-M3.5x14	AATN-2-0020	AAV-06-M3.5x11	ACK-05	4015 M4x11	80-T15
SER/L 2020 K16C	●	●	20	20	125	20							
SER/L 2525 M16C	●	●	25	25	150	25							
SER/L 3232 P16C	●	●	32	32	170	32	22 ER/EL (3.5 - 4.5) ISO METRIC	1020-M4.5x16	AATN-2-0004	AAV-07-M4.5x13	ACK-05	4015 M4x11	80-T20
SER/L 2525 M22C	●	●	25	25	150	25							
SER/L 3232 P22C	●	●	32	32	170	32	16 ER/L (1.5-3 TR)	4015-M3.5x14	-	-	-	-	80-T15
SER/L 4040 S22C	●	●	40	40	250	40							
SER/L 2525 M16C-T	●	●	25	25	150	25	22 ER/L (4-6 TR)	1020-M4.5x16	-	-	-	-	80-T20
SER/L 2020 K16C-S	●	●	20	20	125	25	SNDVK 166 ER/L16	4015-M3.5x14	AATN-2-0020	AAV-06-M3.5x11	-	-	80-T15
SER/L 2525 M16C-S	●	●	25	25	150	31							
SER/L 3232 P16C-S	●	●	32	32	170	38.5							

DIŞ ÇAP DIŞ AÇMA İSVİÇRE TİPİ KAYAR OTOMAT MAKİNA KATERLERİ
EXTERNAL THREADING TOOLHOLDERS FOR SWISS TYPE SLIDING AUTOMATIC LATHES
ДЕРЖАВКА ДЛЯ НАРЕЗАНИЯ НАРУЖНОЙ РЕЗЬБЫ ДЛЯ СТАНКОВ-АВТОМАТОВ ШВЕЙЦАРСКОГО ТИПА

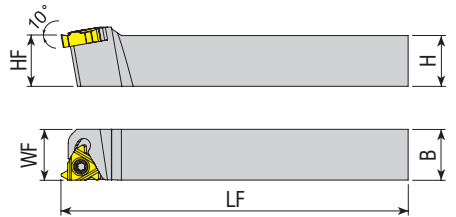
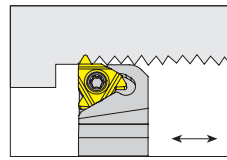

Takım Kodu Ordering Code Код для заказа	Stok Stock Наличие		Takım Ölçüleri (mm) Dimension (mm) Размеры (мм)				Kesici Uç Insert Пластина	Yedek Parçaları / Spare Parts / Запасные части					
	R	L	HF=H	B	LF	WF		Sıkma Vidası Screw Зажимной винт	Altlık Shim Опорная пластина	Altlık Vidası Shim Screw Винт опорной пластины	Baskı Parçası Wedge Clamp Прижим	Baskı Vidası Clamp Screw Зажимной винт	Tork Anahtar Torx Key Торх Ключ
SER/L 1010 K11-S	●	●	10	10	125	10	11 ER/EL	4008-M2.5x6	-	-	-	-	80-T08
SER/L 1212 K11-S	●	●	12	12	125	12							

R: Sağ / Right / Правый L: Sol / Left / Левый ● Stokta / In Stock / В наличии ○ Stokta Yok / Non Stock Item / Нет в наличии

Takımlar standart 1.5° helis açılı olarak üretilir. / The tools have a built in 1.5° helix angle. / Стандартные опорные пластины имеют угол наклона 1.5°

UYARI / WARNING / ПРЕДУПРЕЖДЕНИЕ: Sayfa 130'deki B ve D figürleri uygulanamaz. / The operation for B and D on page 130 can not be applied. / Операции для B и D на стр. 130 не применяется

Sipariş Örneği/Ordering Example/Образец заказа

1 ad./pcs./шт. SER 0808 E11



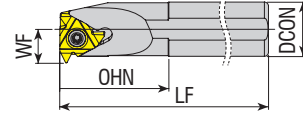
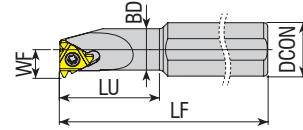
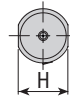
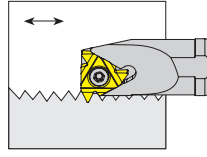

Yedek Parçaları / Spare Parts / Запасные части

Takım Kodu Ordering Code Код для заказа	Stok Stock Наличие		Takım Ölçüleri (mm) Dimension (mm) Размеры (мм)					Kesici Uç Insert Пластина	Sıkma Vidası Screw Зажимной винт	Altlık Shim Опорная пластина	Altlık Vidası Shim Screw Винт опорной пластины	Baskı Parçası Wedge Clamp Прижим	Baskı Vidası Clamp Screw Зажимной винт	Tork Anahtar Torx Key Торкс Ключ	
	R	L	DCON	BD	LF	LU=OHN	WF	DMIN							
SIR/L S12X05H 06	●	○	12	05	100	15	4.3	6.4	06 IR/L	3006-M2X3.6	-	-	-	-	80-T06
SIR/L S16X05H 06	○	●	16	05	100	15	4.3	6.4	08 IR/L	3007-M2.2x5	-	-	-	-	80-T07
SIR/L S16X07M 08	●	●	16	07	150	18	5.3	7.8	11 IR/L	4008-M2.5x6	-	-	-	-	80-T08
SIR/L S10H 11	●	●	10	10	100	-	7.4	12	16 IR/L (0.35 - 3) ISO METRIC	4015-M3.5x9	-	-	-	-	80-T15
SIR/L S12K 11	●	●	12	12	125	-	8.4	16		4015-M3.5x11	-	-	-	-	
SIR/L S16X10M 11	●	●	16	10	150	25	7.4	12		-	-	-	-	-	
SIR/L S16X13M 11	●	●	16	13	150	32	8.9	15		-	-	-	-	-	
SIR/L S16M 11	●	●	16	16	150	-	11.7	19		-	-	-	-	-	
SIR/L S16X13M 16	●	●	16	13	150	32	10.2	16		-	-	-	-	-	
SIR/L S16M 16	●	●	16	16	150	-	11.7	19		-	-	-	-	-	
SIR/L S20X16P 16	●	●	20	16	170	40	11.7	19	4015-M3.5x14	AATN-2-0020	AAV-06-M3.5x11	ACK-05	4015-M4x11	-	
SIR/L S20P 16	●	●	20	20	170	-	13.7	24	-	-	-	-	-	-	
SIR/L S25R 16C	●	●	25	25	200	-	16.2	29	-	-	AAV-08-M3.5x8	-	-	-	
SIR/L S32S 16C	●	●	32	32	250	-	19.7	36	-	-	AAV-06-M3.5x11	ACK-05	4015-M4x11	-	
SIR/L S40T 16C	●	●	40	40	300	-	23.7	44	-	-	-	-	-	-	
SIR/L S50U 16C	●	●	50	50	350	-	28.7	54	-	-	-	-	-	-	
SIR/L S20P 22	●	●	20	20	170	-	15.7	24	4020-M4.5x12	-	-	-	-	-	
SIR/L S25R 22C	●	●	25	25	200	-	18.1	29	-	-	AAV-10-M4.5x8	-	-	-	
SIR/L S32S 22C	●	●	32	32	250	-	21.6	38	1020-M4.5x16	AATN-2-0004	AAV-07-M4.5x13	ACK-05	4015-M4x11	80-T20	
SIR/L S40T 22C	●	●	40	40	300	-	25.6	46	-	-	-	-	-	-	
SIR/L S50U 22C	●	●	50	50	350	-	30.6	58	-	-	-	-	-	-	
SIR/L S25R 16C-T	●	●	25	25	200	-	16.2	29	16 IR/L (1.5-3 TR)	4015-M3.5x14	-	-	-	80-T15	
SIR/L S32S 16C-T	●	●	32	32	250	-	19.7	36	-	-	-	-	-	-	
SIR/L S25R 22C-T	●	●	25	25	200	-	18.1	29	22 IR/L (4-6 TR)	1020-M4.5x16	-	-	-	80-T20	
SIR/L S32S 22C-T	●	●	32	32	250	-	21.6	38	-	-	-	-	-	-	

R: Sağ / Right / Правый L: Sol / Left / Левый ● Stokta / In Stock / В наличии ○ Stokta Yok / Non Stock Item / Нет в наличии
Takımlar standart 1.5° helis açılı olarak üretilir. / The tools have a built in 1.5° helix angle. / Стандартные опорные пластины имеют угол наклона 1.5°
UYARI / WARNING / ПРЕДУПРЕЖДЕНИЕ: Sayfa 131'deki B ve D figürleri uygulanamaz. / The operation for B and D on page 131 can not be applied. / Операции для B и D на стр. 131 не применяется

Sipariş Örneği/Ordering Example/Образец заказа
1 ad./pcs./шт. SIR S12X05H 06

DIŞ ÇAP DIŞ AÇMA KATERLERİ

EXTERNAL THREADING TOOLHOLDERS

ДЕРЖАВКА ДЛЯ НАРЕЗАНИЯ НАРУЖНОЙ РЕЗЬБЫ С РЕГУЛИРОВКОЙ УГЛА НАКЛОНА РЕЖУЩЕЙ ПЛАСТИНЫ

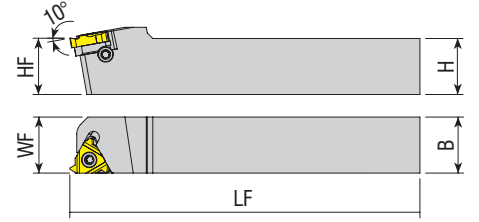
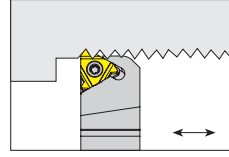
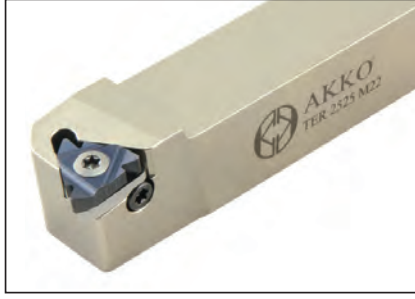

Takım Kodu Ordering Code Код для заказа	Stok Stock Наличие		Takım Ölçüleri (mm) Dimension (mm) Размеры (мм)				Kesici Uç Insert Пластина	Yedek Parçaları / Spare Parts / Запасные части					
	R	L	HF=H	B	LF	WF		Sıkma Vidası Screw Зажимной винт	Sağ Altlık Right Shim U-Platte für WSP rechts	Sol Altlık Left Shim U-Platte für WSP links	Altlık Vidası Shim Screw Винт опорной пластины	Altlık Vidası Pulu Shim Screw Ring Винт опорной пластины/пульт	Tork Anahtar Torx Key Торкс Ключ
TER/L 1616 H16	●	●	16	16	100	16	16 ER/EL	1710-U5-40x12.2	ATS-16E	ATS-16I	AAV-11-U5-40x4.5	ABPL-03	80-T10
TER/L 2020 K16	●	●	20	20	125	20							
TER/L 2525 M16	●	●	25	25	150	25							
TER/L 3232 P16	●	●	32	32	170	32							
TER/L 2525 M22	●	●	25	25	150	25	22 ER/EL	1720-U8-32x15	ATS-22E	ATS-22I	AAV-12-U8-32x5.5	ABPL-04	80-T20
TER/L 3232 P22	●	●	32	32	170	32							
TER/L 4040 S22	●	●	40	40	250	40							
TER/L 2525 M27	●	●	25	25	150	25	27 ER/EL	1620-M5x22	ATS-27E	ATS-27I	AAV-15-M5x5.7	ABPL-05	80-T20
TER/L 3232 P27	●	●	32	32	170	32							
TER/L 4040 S27	●	●	40	40	250	40							

R: Sağ / Right / Правый L: Sol / Left / Левый ● Stokta / In Stock / В наличии ○ Stokta Yok / Non Stock Item / Нет в наличии

Sipariş Örneği/Ordering Example/Образец заказа

Takımlar standart 1.5° helis açılı olarak üretilir. / The tools have a built in 1.5° helix angle. / Стандартные опорные пластины имеют угол наклона 1.5°

1 ad./pcs./шт. TER 1616 H16

DIŞ ÇAP SAĞ YÖNDE VİDA AÇMA EXTERNAL RIGHT HAND THREADING OPERATION НАРЕЗАНИЕ ПРАВОЙ НАРУЖНОЙ РЕЗЬБЫ

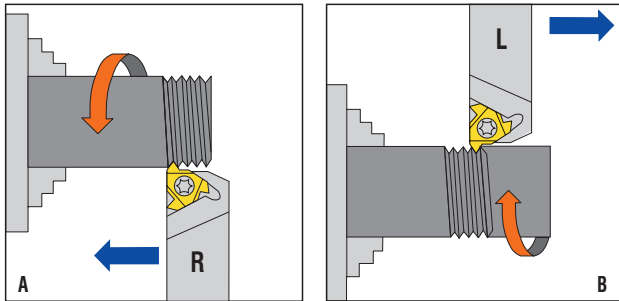

DIŞ ÇAP SOL YÖNDE VİDA AÇMA EXTERNAL LEFT HAND THREADING OPERATION НАРЕЗАНИЕ ЛЕВОЙ НАРУЖНОЙ РЕЗЬБЫ

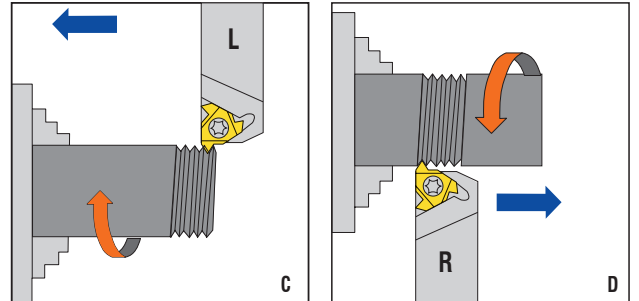

UYARI / WARNING / ВНИМАНИЕ

Figür B ve D için; negatif açılı altlık kullanılmalıdır. / For figure B and D; negative shim must be used. / Для схем B и D необходимо использовать отрицательную подложку под резьбовую пластину. Altiksız katerlerde B ve D figürü uygulanamaz. / B and D figures can not be applied on tools without shim. / Схемы B и D нельзя применять без подкладки под резьбовую пластину.



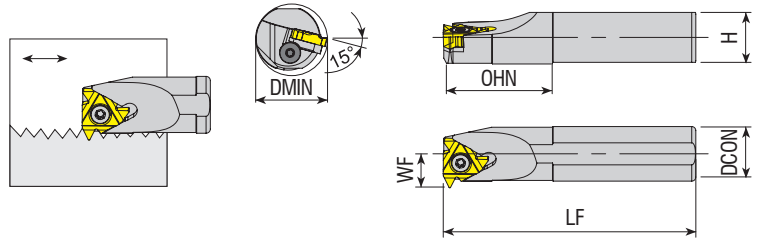

Takım Kodu Ordering Code Код для заказа	Stok Stock Наличие		Takım Ölçüleri (mm) Dimension (mm) Размеры (мм)						Kesici Uç Insert Пластина	Yedek Parçaları / Spare Parts / Запасные части					
	R	L	DCON	WF	LF	OHN	WF	DMIN		Sıkma Vidası Screw Зажимной винт	Sol Altlık Left Shim Ц-Пластина for WSP tools	Sağ Altlık Right Shim Ц-Пластина for WSP tools	Altık Vidası Shim Screw Винт опорной пластины	Altık Vidası Pulu Shim Screw Ring Винт опорной пластины/пруг	Tork Anahtar Torx Key Торх Ключ
TIR/L S25R 16	●	●	25	25	200	-	16.2	29	16 IR/L	1710-U5-40x12.2	ATS-16E	ATS-16I	AAV-11-U5-40x4.5	ABPL-03	80-T10
TIR/L S32S 16	●	●	32	32	250	-	19.7	36							
TIR/L S40T 16	●	●	40	40	300	-	23.7	44							
TIR/L S50U 16	●	●	50	50	350	-	28.7	54							
TIR/L S25R 22	●	●	25	25	200	-	18.1	29	22 IR/L	1720-U8-32x15	ATS-22E	ATS-22I	AAV-12-U8-32x5.5	ABPL-04	80-T20
TIR/L S32S 22	●	●	32	32	250	-	21.6	38							
TIR/L S40T 22	●	●	40	40	300	-	25.6	46							
TIR/L S50U 22	●	●	50	50	350	-	30.6	58							
TIR/L S32S 27	●	●	32	32	250	-	22.6	40	27 IR/L	1620-M5x18	ATS-27E	ATS-27I	AAV-15-M5x5.7	ABPL-05	80-T20
TIR/L S40T 27	●	●	40	40	300	-	26.6	48		1620-M5x22					
TIR/L S50U 27	●	●	50	50	350	-	31.6	58							
TIR/L A25R 16	○	●	25	25	200	50	16.2	29	16 IR/L	1710-U5-40x12.2	ATS-16E	ATS-16I	AAV-11-U5-40x4.5	ABPL-03	80-T10
TIR/L A32S 16	○	●	32	32	250	60	19.7	36							
TIR/L A40T 16	○	●	40	40	300	65	23.9	44							

R: Sağ / Right / Правый L: Sol / Left / Левый ● Stokta / In Stock / В наличии ○ Stokta Yok / Non Stock Item / Нет в наличии
Takımlar standart 1.5° helis açılı olarak üretilir. / The tools have a built in 1.5° helix angle. / Стандартные опорные пластины имеют угол наклона 1.5°

Sipariş Örneği/Ordering Example/Образец заказа
1 ad./pcs./шт. TIR S25R 16

DELİK İÇİ SAĞ YÖNDE VİDA AÇMA
INTERNAL RIGHT HAND THREADING OPERATION
НАРЕЗАНИЕ ПРАВОЙ НАРУЖНОЙ РЕЗЬБЫ

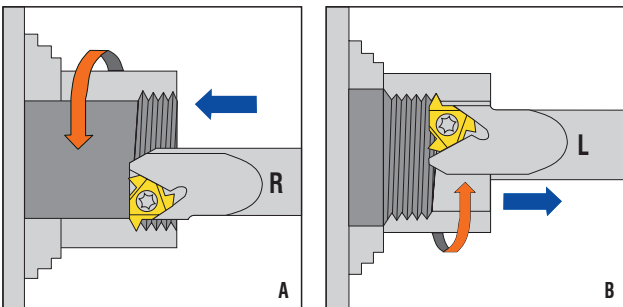

DELİK İÇİ SOL YÖNDE VİDA AÇMA
INTERNAL LEFT HAND THREADING OPERATION
НАРЕЗАНИЕ ЛЕВОЙ НАРУЖНОЙ РЕЗЬБЫ

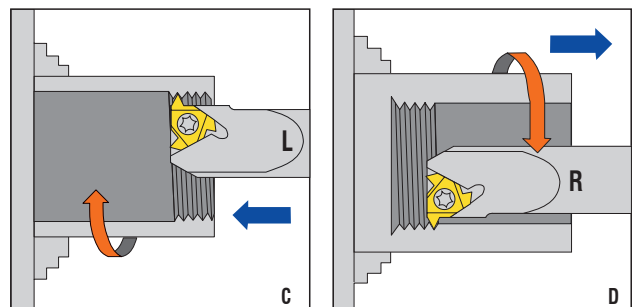

UYARI / WARNING / ВНИМАНИЕ

Figür B ve D için; negatif açılı altlık kullanılmalıdır. / For figure B and D; negative shim must be used. / Für Abbildung B und D; negative Unterlage verwenden.
Altıksız katerlerde B ve D figürü uygulanamaz. / B and D figures can not be applied on tools without shim. / Схемы B и D нельзя применять без подкладки под резьбовую пластину

Diş Helis Açısı Thread Helix Angle Угол подъема резьбы

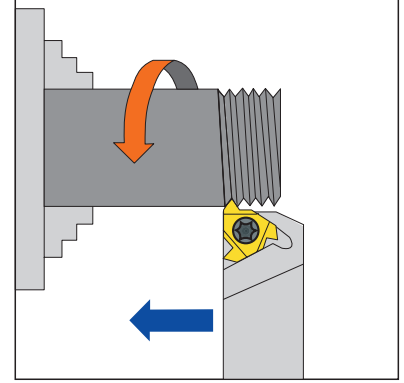
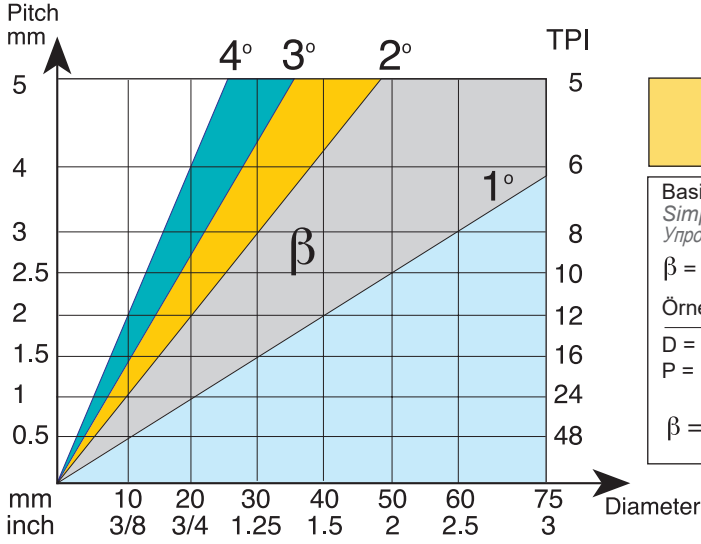

Standart ve Eğik Altlıklar Standard and Slanted Shim Стандартная и наклонная опорная пластина

Akko diş açma takımlarının, uç yuvaları 1.5° helis açılı olarak üretilir. Farklı helis açılı diş açmak isteyenler altlığı değiştirerek istedikleri dereceyi elde edebilirler. Negatif helis genellikle sol katerde sağ diş çekmek için kullanılır ya da sağ katerde sol diş çekmek için kullanılır.

Akko Toolholders Pockets have a built in 1.5° helix angle. This angle may be adjusted to better match the thread helix angle by simply changing the shim. Negative helix is usually used when threading RH thread with LH Holder or LH thread with RH Holder.

Державки АККО имеют стандартный угол наклона опорной пластины 1,5°. Этот угол можно отрегулировать путем замены опорной пластины. Отрицательный угол наклона обычно используется когда правая резьба RH нарезается левой державкой LH или левая резьба LH нарезается правой державкой RH.

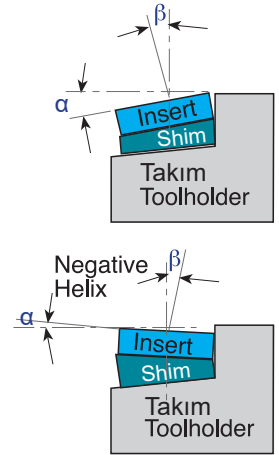

L	IC	Takım Tipi Tool Type Тип Инструмента	Uç Yuvasının Açısı (α) / Pocket's Angle (α) / Угол наклона (α)						
			4.5°	3.5°	2.5°	1.5°	0.5°	-0.5°	-1.5°
16	3/8	EX-RH or IN-LH	ATS-16E+4.5	ATS-16E+3.5	ATS-16E+2.5	ATS-16E	ATS-16E+0.5	ATS-16E-0.5	ATS-16E-1.5
16	3/8	EX-LH or IN-RH	ATS-16I+4.5	ATS-16I+3.5	ATS-16I+2.5	ATS-16I	ATS-16I+0.5	ATS-16I-0.5	ATS-16I-1.5
22	1/2	EX-RH or IN-LH	ATS-22E+4.5	ATS-22E+3.5	ATS-22E+2.5	ATS-22E	ATS-22E+0.5	ATS-22E-0.5	ATS-22E-1.5
22	1/2	EX-LH or IN-RH	ATS-22I+4.5	ATS-22I+3.5	ATS-22I+2.5	ATS-22I	ATS-22I+0.5	ATS-22I-0.5	ATS-22I-1.5
27	5/8	EX-RH or IN-LH	ATS-27E+4.5	ATS-27E+3.5	ATS-27E+2.5	ATS-27E	ATS-27E+0.5	ATS-27E-0.5	ATS-27E-1.5
27	5/8	EX-LH or IN-RH	ATS-27I+4.5	ATS-27I+3.5	ATS-27I+2.5	ATS-27I	ATS-27I+0.5	ATS-27I-0.5	ATS-27I-1.5

Altlık Değişirme Öneri Tablosu / Shim Change Recommendation Рекомендации по смене опорной пластины

Tabloda da görüldüğü gibi bazı diş hatvelerinin çaplara göre kombinasyonları altlık değişimini gerektirir. Eğer değişim gerekli ise EX-RH ve IN-LH katerleri için ATS-E altlıklarını, IN-RH ve EX-LH katerleri için ATS-I altlıklarını kullanın.

As can be seen from the chart, some Pitch to Diameter combinations require a shim change. If change is required, use ATS-E shim for EX-RH and IN-LH toolholders and ATS-I shims for IN-RH and EX-LH toolholders.

Как видно из диаграммы, некоторые комбинации Шаг на Диаметр требуют замены опорной пластины. Если требуется замена, используйте опорные пластины ATS-E для державок инструментов EX-RH и IN-LH и опорные пластины ATS-I для державок IN-RH и EX-LH.

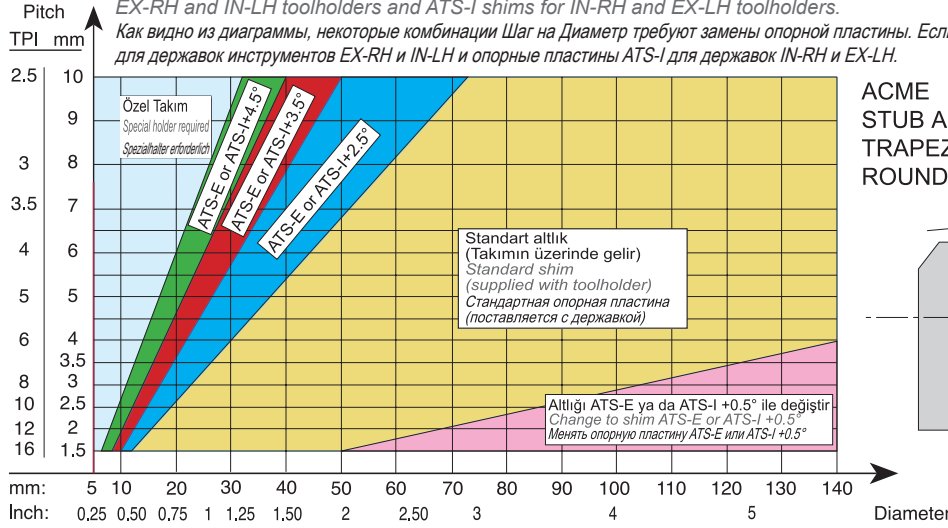

ACME
 STUB ACME
 TRAPEZ (DIN 103)
 ROUND (DIN 405)

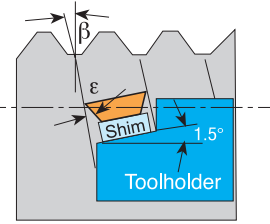

Tabloda da görüldüğü gibi çoğu uygulamalar altlık değişimine ihtiyaç duymaz. Eğer değişime ihtiyaç duyulursa EX-RH ve IN-LH katerleri için ATS-E altlıklarını, IN-RH ve EX-RH katerleri için ATS-I altlıklarını kullanın.

As can be seen from the chart, most applications do not require a shim change. If change is required, use ATS-E shims for EX-RH and IN-LH toolholders and ATS-I shims for IN-RH and EX-LH toolholders.

Как видно из диаграммы, некоторые комбинации Шаг на Диаметр требуют замены опорной пластины. Если требуется замена, используйте опорные пластины ATS-E для державок инструментов EX-RH и IN-LH и опорные пластины ATS-I для державок IN-RH и EX-LH.

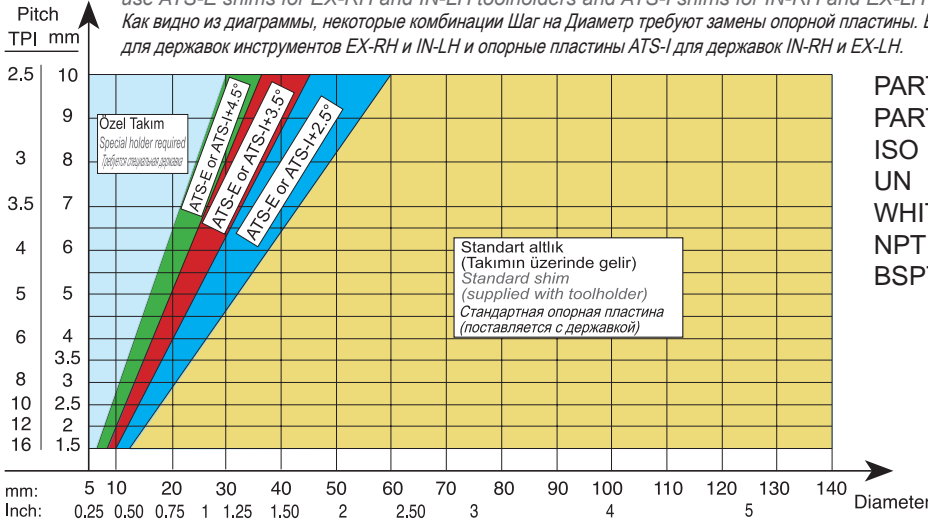

PARTIAL PROFILES 60°
 PARTIAL PROFILES 55°
 ISO
 UN
 WHIT.
 NPT
 BSPT

Tabloda da görüldüğü gibi çoğu uygulamalar altlık değişimine ihtiyaç duyar. Çoğu durumda negatif bir altlığa ihtiyaç duyulur. EX-RH ve IN-LH takımlar için ATS-E altlıklarını kullanın. IN-RH ve EX-LH takımlar için ATS-I altlıklarını kullanın.

As can be seen from the chart, most applications require a shim change. In most cases a negative shim is required, use ATS-E shims for EX-RH and IN-LH toolholders. ATS-I shims for IN-RH and EX-LH toolholders.

Как видно из диаграммы, в большинстве случаев требуется смена опорной пластины. В основном применяется отрицательная опорная пластина, используйте опорные пластины ATS-E для державок EX-RH и IN-LH. Опорные пластины ATS-I для державок IN-RH и EX-LH.

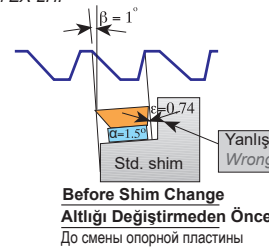
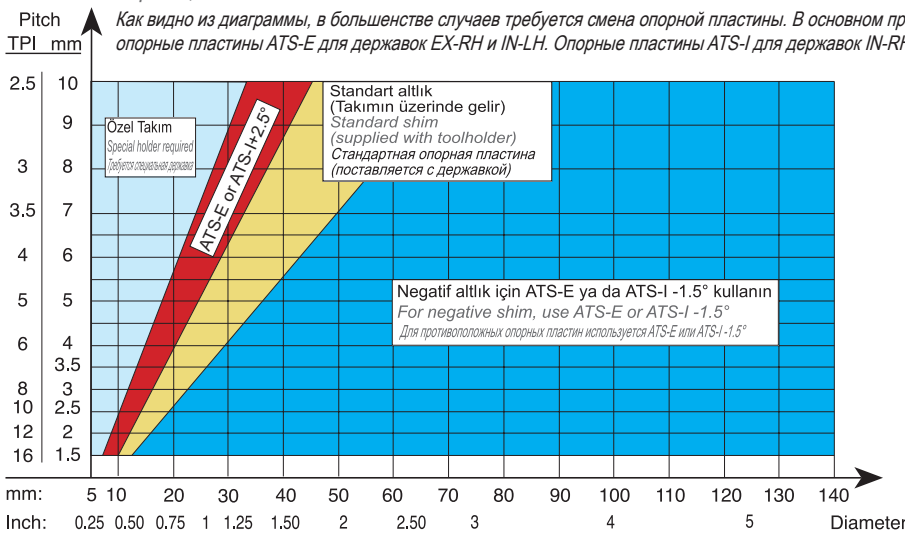

Before Shim Change
 Altlığı Değiştirmeden Önce
 До смены опорной пластины

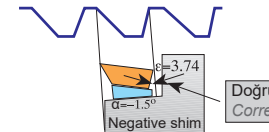

After Shim Change
 Altlığı Değiştirdikten Sonra
 После смены опорной пластины

AMERICAN
 BUTTRESS
 SAGENGWINDE
 (DIN 513)

Standart altlığın negatif bir altlıkla değiştirilmesi, kenar sürtmesini engelleyecektir.

Replacing the standard shim with a shim has negative angle, will eliminate side rubbing
 Смена стандартной опорной пластины на пластину с отрицательным углом устраняет боковое трение



konusulan
the spoken *kalite...*
quality...

KANAL AÇMA

KANAL AÇMA TAKIMLARI
GROOVING TOOLHOLDERS
ДЕРЖАВКИ ДЛЯ ОБРАБОТКИ КАНАВОК





AKKO **A** **AKT** - **K** - **R** - **2525**

1 2 3 4 5

100 - 150 - **4** - **T22**

6 7 8

2 Kesici Stili / *Cutter Style* / Тип режущего инструмента

DKT: Dış Çap Kanal Açma Takımı / *External Grooving Toolholders*
ДЕРЖАВКИ ДЛЯ ОБРАБОТКИ НАРУЖНЫХ КАНАВОК
IKT: Delik İçi Kanal Açma Takımı / *Internal Grooving Toolholders*
ДЕРЖАВКИ ДЛЯ ОБРАБОТКИ ВНУТРЕННИХ КАНАВОК
AKT: Dış Çap Alın Kanal Takımları / *Face Grooving Toolholders*
ДЕРЖАВКА ДЛЯ ОБРАБОТКИ ТОРЦЕВЫХ КАНАВОК
LKT: L Tip Alın Kanal Açma Takımı / *L Type Face Grooving Toolholders*
ДЕРЖАВКА L-ТИПА ДЛЯ ОБРАБОТКИ ТОРЦЕВЫХ КАНАВОК

3 Uç Tipi / *Insert Type* / Форма пластины

KRLY / MGM.
HRN / S312, S229, S224, S223
ISCR / DGN, GI, GTN
SNDVK / 123, 151, 154.91
ZCC
KM / A4.
ARN / LOMR.
TGTC / TD.

4 Kesme Yönü / *Cutting Direction*
Направление резания

R L

5 Kesme Kenar Yüksekliği ve Şaft Genişliği
Cutting Edge Height and Shank Width
Высота и Ширина державки

H
B
DCON

6 Kesme Aralığı
Cutting Diameter
Диаметр Резания

DAXX (150)
DAXIN (100)

7 Kesme Kenar Genişliği / *Cutting Width Edge*
Ширина режущей кромки

ÖR/E.G :
2 = 2.0 mm
3 = 3.0 mm
4 = 4.0 mm
5 = 5.0 mm
6 = 6.0 mm
8 = 8.0 mm

CW

8 Kesme Derinliği / *Cutting Depth* / Глубина резания

CDX
CDX

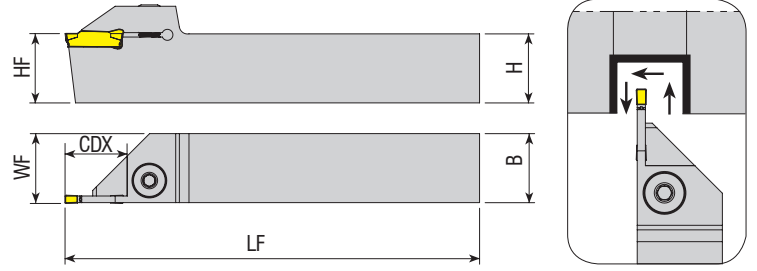

Takım Kodu Ordering Code Код для заказа	Stok Stock Наличие		Takım Ölçüleri (mm) Dimension (mm) Размеры (мм)					Kesici Uç Insert Пластина	Yedek Parçaları / Spare Parts / Запасные части		
	R	L	HF=H	B	LF	WF	CDX		Sıkma Vidası Screw Зажимной винт	Pul Stamp Шайба	Anahtar Allen Key Ключ
ADKT-K-R/L-1212-1.5-T15	●	●	12	12	100	12.2	15	MGM. - 1.5	AKV-02-M6x22	ABPL-01	AAL-03-3
ADKT-K-R/L-2020-1.5-T15	●	●	20	20	125	20.2	15				
ADKT-K-R/L-1212-2-T15	●	●	12	12	100	16.3	15	MGM. - 2	AKV-02-M6x22	ABPL-01	AAL-03-3
ADKT-K-R/L-1616-2-T10	●	●	16	16	125	16.3	10				
ADKT-K-R/L-1616-2-T15	●	●	16	16	125	16.3	15				
ADKT-K-R/L-2020-2-T15	●	●	20	20	150	20.3	15				
ADKT-K-R/L-2525-2-T15	●	●	25	25	150	25.3	15				
ADKT-K-R/L-3232-2-T15	●	●	32	32	170	32.3	15				
ADKT-K-R/L-1212-3-T15	●	●	12	12	100	12.3	15	MGM. - 3			
ADKT-K-R/L-1616-3-T15	●	●	16	16	125	16.3	15				
ADKT-K-R/L-2020-3-T10	●	●	20	20	125	20.3	10				
ADKT-K-R/L-2020-3-T20	●	●	20	20	125	20.3	20				
ADKT-K-R/L-2020-3-R28	●	●	20	20	125	20.3	28				
ADKT-K-R/L-2525-3-T10	●	●	25	25	150	25.3	10				
ADKT-K-R/L-2525-3-R15	●	●	25	25	150	25.3	15				
ADKT-K-R/L-2525-3-T22	●	●	25	25	150	25.3	22				
ADKT-K-R/L-3232-3-T10	●	●	32	32	170	32.3	10				
ADKT-K-R/L-3232-3-T22	●	●	32	32	170	32.3	22				
ADKT-K-R/L-2020-4-T10	●	●	20	20	125	20.4	10	MGM. - 4	2004-M8x1x20	-	AAL-05-4
ADKT-K-R/L-2020-4-T20	●	●	20	20	125	20.4	20				
ADKT-K-R/L-2020-4-R25	●	○	20	20	125	20.4	25				
ADKT-K-R/L-2525-4-T10	●	●	25	25	150	25.4	10				
ADKT-K-R/L-2525-4-T18	●	●	25	25	150	25.4	18				
ADKT-K-R/L-2525-4-T22	●	●	25	25	150	25.4	22				
ADKT-K-R/L-3232-4-T10	●	●	32	32	170	32.4	10				
ADKT-K-R/L-3232-4-T22	●	●	32	32	170	32.4	22				
ADKT-K-R/L-2020-5-T20	●	●	20	20	125	20.5	20	MGM. - 5			
ADKT-K-R/L-2525-5-T15	●	●	25	25	150	25.5	15				
ADKT-K-R/L-2525-5-T18	●	●	25	25	150	25.5	18				
ADKT-K-R/L-2525-5-T25	●	●	25	25	150	25.5	25				
ADKT-K-R/L-3232-5-T15	●	●	32	32	170	32.5	15				
ADKT-K-R/L-3232-5-T25	●	●	32	32	170	32.5	25				
ADKT-K-R/L-2525-6-T15	●	●	25	25	150	25.6	15	MGM. - 6			
ADKT-K-R/L-2525-6-T25	●	●	25	25	150	25.6	25				
ADKT-K-R/L-3232-6-T25	●	●	32	32	170	32.6	25	MGM. - 8			
ADKT-K-R/L-3232-8-T32	●	●	32	32	170	32.8	32				

R: Sağ / Right / Правый L: Sol / Left / Левый

● Stokta / In Stock / В наличии ○ Stokta Yok / Non Stock Item / Нет в наличии

KRLY - JD Ucuna Uygun / Compatible with KRLY - JD Insert. / Под пластину KRLY - JD

Sipariş Örneği/Ordering Example/Образец заказа

1 ad./pcs./шт. ADKT-K-R-1212-1.5-T15

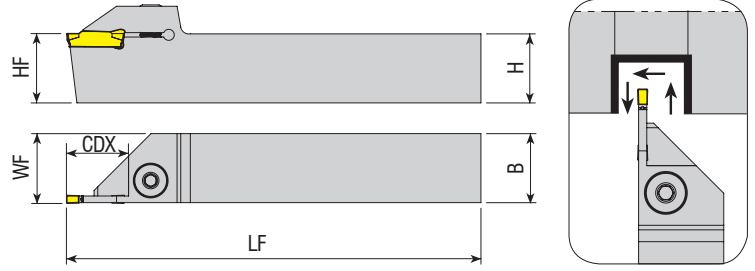
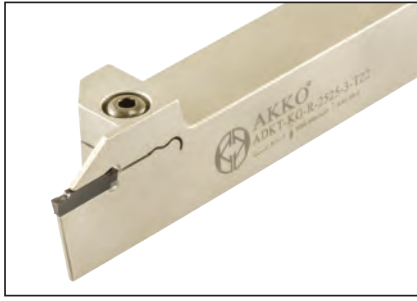

Takım Kodu Ordering Code Код для заказа	Stok Stock Наличие		Takım Ölçüleri (mm) Dimension (mm) Размеры (мм)					Kesici Uç Insert Пластина	Yedek Parçaları / Spare Parts / Запасные части		
	R	L	HF=H	B	LF	WF	CDX		Sıkma Vidası Screw Зажимной винт	Pul Stamp Шайба	Anahtar Allen Key Ключ
ADKT-KG-R/L-2020-2-T15	●	●	20	20	125	20.2	15	KG.. - 2	AKV-02-M6x22	ABPL-01	AAL-03-3
ADKT-KG-R/L-2525-2-T8	●	●	25	25	150	25.2	8				
ADKT-KG-R/L-2525-2-T15	●	○	25	25	150	25.2	15				
ADKT-KG-R/L-2525-2-T17	●	○	25	25	150	25.2	17	KG.. - 3	2004-M8x1x20	-	AAL-05-4
ADKT-KG-R/L-1616-3-T20	●	●	16	16	125	16.3	20				
ADKT-KG-R/L-2020-3-T20	●	●	20	20	125	20.3	20				
ADKT-KG-R/L-2525-3-T10	●	●	25	25	150	25.3	10				
ADKT-KG-R/L-2525-3-T13	●	●	25	25	150	25.3	13				
ADKT-KG-R/L-2525-3-T22	●	●	25	25	150	25.3	22				
ADKT-KG-R/L-2020-4-T20	●	●	20	20	125	20.4	20	KG.. - 4	2004-M8x1x20	-	AAL-05-4
ADKT-KG-R/L-2525-4-T10	●	●	25	25	150	25.4	10				
ADKT-KG-R/L-2525-4-T16	●	○	25	25	150	25.4	16				
ADKT-KG-R/L-2525-4-T22	●	○	25	25	150	25.4	22				
ADKT-KG-R/L-2525-5-T12	●	●	25	25	150	25.5	12	KG.. - 5	2004-M8x1x20	-	AAL-05-4
ADKT-KG-R/L-2525-5-T15	●	●	25	25	150	25.5	15				
ADKT-KG-R/L-2525-5-T25	●	○	25	25	150	25.5	25				
ADKT-KG-R/L-2525-6-T25	○	○	25	25	150	25.6	25	KG.. - 6	2004-M8x1x20	-	AAL-05-4

R: Sağ / Right / Правый L: Sol / Left / Левый
● Stokta / In Stock / В наличии ○ Stokta Yok / Non Stock Item / Нет в наличии
KRLY Ucuna Uygunudur. / Compatiple with KRLY Insert. / Под пластины KRLY

Sipariş Örneği/Ordering Example/Образец заказа
1 ad./pcs./шт. ADKT-KG-R-2020-2-T15



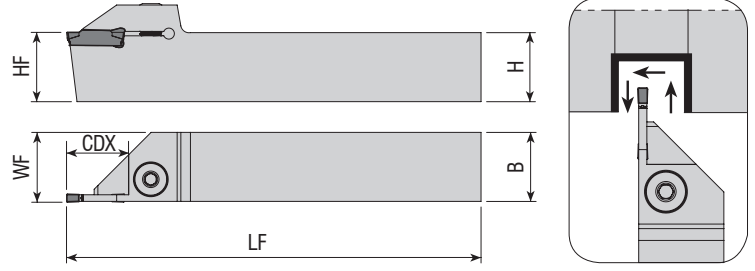

Takım Kodu Ordering Code Код для заказа	Stok Stock Наличие		Takım Ölçüleri (mm) Dimension (mm) Размеры (мм)				Kesici Uç Insert Пластина	Yedek Parçaları / Spare Parts / Запасные части			
	R	L	HF=H	B	LF	WF		CDX	Sıkma Vidası Screw Зажимной винт	Pul Stamp Шайба	Anahtar Allen Key Ключ
ADKT-SGC-R/L-1212-2-R15	●	●	12	12	100	16.2	15	GCM N20	AKV-02-M6x22	ABPL-01	AAL-03-3
ADKT-SGC-R/L-1616-2-R15	●	●	16	16	125	16.2	15				
ADKT-SGC-R/L-2020-2-R20	●	●	20	20	125	20.2	20				
ADKT-SGC-R/L-2525-2-R20	●	●	25	25	150	25.2	20				
ADKT-SGC-R/L-1212-3-R15	●	●	12	12	100	16.3	15	GCM N30	2004-M8x1x20	-	AAL-05-4
ADKT-SGC-R/L-1616-3-R15	●	●	16	16	125	16.3	15				
ADKT-SGC-R/L-2020-3-R22	●	●	20	20	125	20.3	22				
ADKT-SGC-R/L-2525-3-R15	●	○	25	25	150	25.3	15				
ADKT-SGC-R/L-2525-3-R22	●	●	25	25	150	25.3	22				
ADKT-SGC-R/L-2525-4-R25	●	○	25	25	150	25.4	25	GCM N40			

SMTM Ucuna Uygundur. / Compatible with SMTM Insert. / Под пластину SMTM

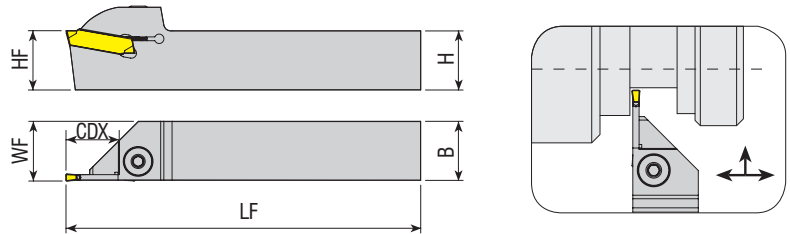

Takım Kodu Ordering Code Код для заказа	Stok Stock Наличие		Takım Ölçüleri (mm) Dimension (mm) Размеры (мм)				Kesici Uç Insert Пластина	Yedek Parçaları / Spare Parts / Запасные части			
	R	L	HF=H	B	LF	WF		CDX	Sıkma Vidası Screw Зажимной винт	Pul Stamp Шайба	Anahtar Allen Key Ключ
ADKT-H-R/L-2020-3-T20	●	●	20	20	125	20.5	20	S229 - 3			
ADKT-H-R/L-2525-3-T22	●	●	25	25	150	25.5	22				
ADKT-H-R/L-2525-3-T26	●	●	25	25	150	25.5	26				
ADKT-H-R/L-2020-4-T20	●	●	20	20	125	20.5	20	S229 - 4	2004-M8x1x20	-	AAL-05-4
ADKT-H-R/L-2525-4-T22	●	●	25	25	150	25.5	22				
ADKT-H-R/L-3232-4-T22	●	●	32	32	170	32.5	22				
ADKT-H-R/L-2020-5-T20	●	●	20	20	125	20.5	20				
ADKT-H-R/L-2525-5-T25	●	●	25	25	150	25.5	25	S229 - 5			
ADKT-H-R/L-2525-6-T25	●	●	25	25	150	25.6	25	S229 - 6			

R: Sağ / Right / Правый L: Sol / Left / Левый

● Stokta / In Stock / В наличии ○ Stokta Yok / Non Stock Item / Нет в наличии

HRN Ucuna Uygundur. / Compatible with HRN Insert. / Под пластину HRN

Sipariş Örneği/Ordering Example/Образец заказа

1 ad./pcs./шт. ADKT-SGC-R-1212-2-R15

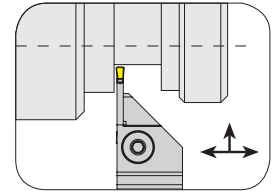
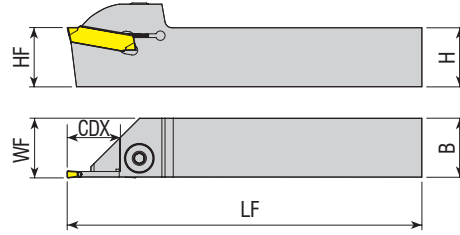

Takım Kodu Ordering Code Код для заказа	Stok Stock Наличие		Takım Ölçüleri (mm) Dimension (mm) Размеры (мм)				Kesici Uç Insert Пластина	Yedek Parçaları / Spare Parts / Запасные части			
	R	L	HF=H	B	LF	WF		CDX	Sıkma Vidası Screw Зажимной винт	Pul Stamp Шайба	Anahtar Allen Key Ключ
ADKT-HK-R/L-1616-2-T15	●	●	16	16	125	16.3	15	S224 - 2	AKV-02-M6x22	ABPL-01	AAL-03-3
ADKT-HK-R/L-2020-2-T15	●	●	20	20	125	20.3	15				
ADKT-HK-R/L-2525-2-T15	●	●	25	25	150	25.3	15				
ADKT-HK-R/L-1616-3-T15	○	○	16	16	125	16.3	15	S224 - 3	2004-M8x1x20	-	AAL-05-4
ADKT-HK-R/L-2020-3-T20	●	●	20	20	125	20.4	20				
ADKT-HK-R/L-2525-3-T22	●	●	25	25	150	25.4	22				
ADKT-HK-R/L-2020-4-T20	●	●	20	20	125	20.4	20				
ADKT-HK-R/L-2525-4-T22	●	●	25	25	150	25.4	22	S224 - 4			
ADKT-HS223-R/L-2020-2-T15	●	○	20	20	125	20.4	15				
ADKT-HS223-R/L-2020-3-T17	●	○	20	20	125	20.3	17	S223 - 3	2004-M8x1x20	-	AAL-05-4

HRN Ucuna Uygundur. / Compatible with HRN Insert. / Под пластину HRN

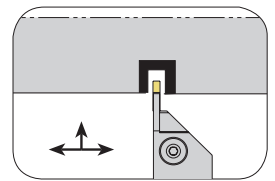
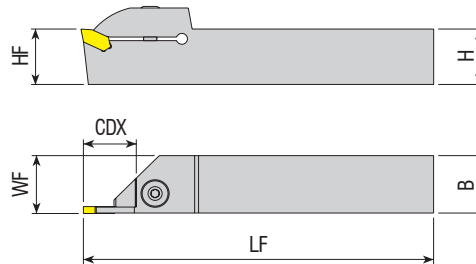

Takım Kodu Ordering Code Код для заказа	Stok Stock Наличие		Takım Ölçüleri (mm) Dimension (mm) Размеры (мм)				Kesici Uç Insert Пластина	Yedek Parçaları / Spare Parts / Запасные части			
	R	L	HF=H	B	LF	WF		CDX	Sıkma Vidası Screw Зажимной винт	Pul Stamp Шайба	Anahtar Allen Key Ключ
ADKT-ZCC1-R/L-2020-3-T20	●	○	20	20	125	20.3	20	ZQMX - 3	2004-M8x1x20	-	AAL-05-4
ADKT-ZCC1-R/L-2525-3-T22	●	○	25	25	150	25.3	22				
ADKT-ZCC1-R/L-2020-4-T20	●	○	20	20	125	20.4	20	ZQMX - 4			
ADKT-ZCC1-R/L-2525-4-T22	●	○	25	25	150	25.4	22				

R: Sağ / Right / Правый L: Sol / Left / Левый

● Stokta / In Stock / В наличии ○ Stokta Yok / Non Stock Item / Нет в наличии
ZCC Ucuna Uygundur. / Compatible with ZCC Insert. / Под пластину ZCC.

Sipariş Örneği/Ordering Example/Образец заказа
1 ad./pcs./шт. ADKT-HK-R-1616-2-T15

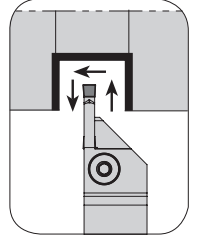
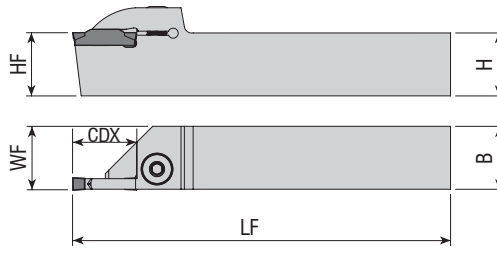

Takım Kodu Ordering Code Код для заказа	Stok Stock Наличие		Takım Ölçüleri (mm) Dimension (mm) Размеры (мм)					Kesici Uç Insert Пластина	Yedek Parçaları / Spare Parts / Запасные части			
	R	L	HF=H	B	LF	WF	CDX		Sıkma Vidası Screw Зажимной винт	Pul Stamp Шайба	Anahtar Allen Key Ключ	
ADKT-ZCC2-R/L-1616-2-T15	●	●	16	16	125	16.2	15	Z.BD - 2	AKV-02-M6x22	ABPL-01	AAL-03-3	
ADKT-ZCC2-R/L-2020-2-T7	●	●	20	20	125	20.2	7					
ADKT-ZCC2-R/L-2020-2-T15	●	●	20	20	125	20.2	15					
ADKT-ZCC2-R/L-2525-2-T15	●	●	25	25	150	25.2	15	Z.ED - 2.5				
ADKT-ZCC2-R/L-1616-2.5-T15	●	●	16	16	125	16.3	15					
ADKT-ZCC2-R/L-2020-2.5-T17	●	●	20	20	125	20.3	17					
ADKT-ZCC2-R/L-2525-2.5-T15	●	●	25	25	150	25.3	15	Z.FD - 3				
ADKT-ZCC2-R/L-1616-3-T15	●	●	16	16	125	16.3	15					
ADKT-ZCC2-R/L-1616-3-T17	●	○	16	16	125	16.3	17					
ADKT-ZCC2-R/L-1616-3-T20	●	○	16	16	125	16.3	20	Z.GD - 4	2004-M8x1x20	-	AAL-05-4	
ADKT-ZCC2-R/L-2020-3-T12	●	●	20	20	125	20.3	12					
ADKT-ZCC2-R/L-2020-3-T20	●	●	20	20	125	20.3	20					
ADKT-ZCC2-R/L-2020-3-R21	●	○	20	20	125	20.3	21	Z.HD - 5				
ADKT-ZCC2-R/L-2020-3-R25	●	●	20	20	125	20.3	25					
ADKT-ZCC2-R/L-2525-3-T12	●	○	25	25	150	25.3	12					
ADKT-ZCC2-R/L-2525-3-T22	●	●	25	25	150	25.3	22	Z.KD - 6				
ADKT-ZCC2-R/L-2525-3-R30	●	●	25	25	150	25.3	30					
ADKT-ZCC2-R/L-2020-4-T12	●	○	20	20	125	20.5	12					
ADKT-ZCC2-R/L-2020-4-T20	●	●	20	20	125	20.5	20	Z.HD - 5				
ADKT-ZCC2-R/L-2525-4-T12	●	●	25	25	150	25.5	12					
ADKT-ZCC2-R/L-2525-4-T22	●	●	25	25	150	25.5	22					
ADKT-ZCC2-R/L-2020-5-T12	●	○	20	20	125	20.5	12	Z.HD - 5				
ADKT-ZCC2-R/L-2020-5-T20	●	●	20	20	125	20.5	20					
ADKT-ZCC2-R/L-2525-5-T12	●	○	25	25	150	25.5	12					
ADKT-ZCC2-R/L-2525-5-T25	●	●	25	25	150	25.5	25	Z.KD - 6				
ADKT-ZCC2-R/L-3232-5-T25	●	●	32	32	170	32.5	25					
ADKT-ZCC2-R/L-2020-6-T20	●	●	20	20	125	20.6	20					
ADKT-ZCC2-R/L-2525-6-T25	●	●	25	25	150	25.6	25	Z.KD - 6				
ADKT-ZCC2-R/L-3232-6-T25	●	●	32	32	170	32.6	25					
ADKT-ZCC2-R/L-3232-6-T30	●	●	32	32	170	32.6	30					

R: Sağ / Right / Правый L: Sol / Left / Левый
● Stokta / In Stock / В наличии ○ Stokta Yok / Non Stock Item / Нет в наличии
ZCC Ucuna Uygunudur. / Compatible with ZCC Insert. / Под пластину ZCC

Sipariş Örneği/Ordering Example/Образец заказа
1 ad./pcs./шт. ADKT-ZCC2-R-1616-2-T15

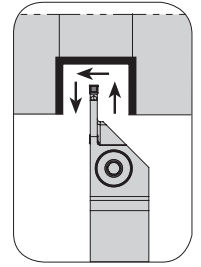
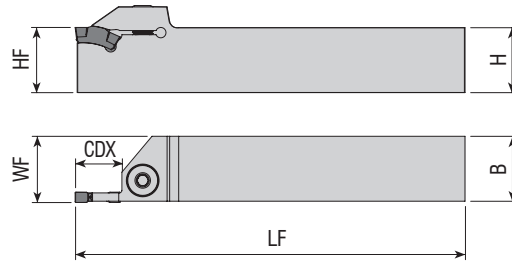

Takım Kodu
Ordering Code
Код для заказа

Takım Kodu Ordering Code Код для заказа	Stok Stock Наличие		Takım Ölçüleri (mm) Dimension (mm) Размеры (мм)					Kesici Uç Insert Пластина	Yedek Parçaları / Spare Parts / Запасные части		
	R	L	HF=H	B	LF	WF	CDX		Sıkma Vidası Screw Зажимной винт	Pul Stamp Шайба	Anahtar Allen Key Ключ
ADKT-ITG-R/L-2020-3-T8	●	●	20	20	125	20.3	8	TGM. - 3	2004-M8x1x20	-	AAL-05-4
ADKT-ITG-R/L-2525-3-T8	●	●	25	25	150	25.3	8				
ADKT-ITG-R/L-3232-3-T8	●	○	32	32	170	32.3	8				
ADKT-ITG-R/L-2020-4-T9	●	●	20	20	125	20.4	9	TGM. - 4			
ADKT-ITG-R/L-2525-4-T17	●	●	25	25	150	25.4	17				
ADKT-ITG-R/L-3232-4-T17	●	●	32	32	170	32.4	17	TGM. - 5			
ADKT-ITG-R/L-3232-5-T25	●	○	32	32	170	32.5	25				

ISCR Ucuna Uygun. / Compatible with ISCR Insert. / Под пластину ISCR.

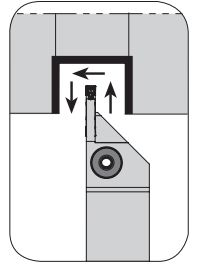
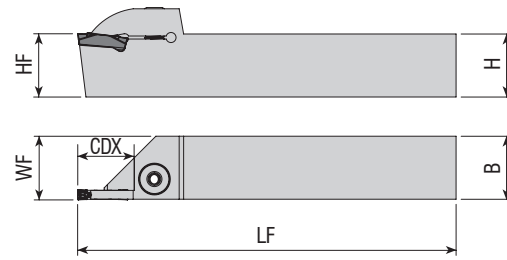

Takım Kodu
Ordering Code
Код для заказа

Takım Kodu Ordering Code Код для заказа	Stok Stock Наличие		Takım Ölçüleri (mm) Dimension (mm) Размеры (мм)					Kesici Uç Insert Пластина	Yedek Parçaları / Spare Parts / Запасные части		
	R	L	HF=H	B	LF	WF	CDX		Sıkma Vidası Screw Зажимной винт	Pul Stamp Шайба	Anahtar Allen Key Ключ
ADKT-KM-R/L-2020-2-T15	●	●	20	20	125	20.3	15	A4. - 2	AKV-02-M6x22	ABPL-01	AAL-03-3
ADKT-KM-R/L-2525-2-T15	●	●	25	25	150	25.3	15				
ADKT-KM-R/L-2020-3-T20	●	●	20	20	125	20.4	20	A4. - 3	2004-M8x1x20	-	AAL-05-4
ADKT-KM-R/L-2525-3-T22	●	●	25	25	150	25.4	22				
ADKT-KM-R/L-2525-4-T22	●	●	25	25	150	25.5	22	A4. - 4			

R: Sağ / Right / Правый L: Sol / Left / Левый

● Stokta / In Stock / В наличии ○ Stokta Yok / Non Stock Item / Нет в наличии

KNMTL Ucuna Uygun. / Compatible with KNMTL Insert. / Под пластину KNMTL.

Sipariş Örneği/Ordering Example/Образец заказа

1 ad./pcs./шт. ADKT-KM-R-2020-2-T15

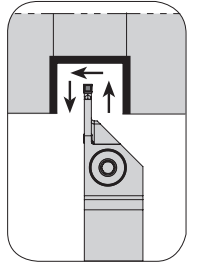
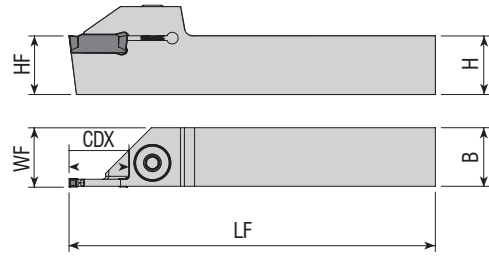

Takım Kodu Ordering Code Код для заказа	Stok Stock Наличие		Takım Ölçüleri (mm) Dimension (mm) Размеры (мм)				Kesici Uç Insert Пластина	Yedek Parçaları / Spare Parts / Запасные части			
	R	L	HF=H	B	LF	WF		CDX	Sıkma Vidası Screw Зажимной винт	Pul Stamp Шайба	Anahtar Allen Key Ключ
ADKT-I-R/L-1212-2-T15	●	●	12	12	125	16.3	15	DGN - 2	AKV-02-M6x22	ABPL-01	AAL-03-3
ADKT-I-R/L-1616-2-T15	●	●	16	16	100	16.3	15				
ADKT-I-R/L-2020-2-T15	●	●	20	20	125	20.3	15				
ADKT-I-R/L-2525-2-T15	●	●	25	25	150	25.3	15				
ADKT-I-R/L-3232-2-T15	●	●	32	32	170	32.3	15				
ADKT-I-R/L-1212-3-T15	●	●	12	12	100	16.3	15	DGN - 3			
ADKT-I-R/L-1616-3-T15	●	●	16	16	125	16.3	15				
ADKT-I-R/L-2020-3-T12	●	●	20	20	125	20.3	12				
ADKT-I-R/L-2020-3-T20	●	●	20	20	125	20.3	20				
ADKT-I-R/L-2525-3-T12	●	●	25	25	150	25.3	12				
ADKT-I-R/L-2525-3-T22	●	●	25	25	150	25.3	22				
ADKT-I-R/L-3232-3-T22	●	●	32	32	170	32.3	22				
ADKT-I-R/L-2020-4-T20	●	●	20	20	125	20.4	20	DGN / GRP - 4	2004-M8x1x20	-	AAL-05-4
ADKT-I-R/L-2525-4-T12	●	●	25	25	150	25.4	12				
ADKT-I-R/L-2525-4-T22	●	●	25	25	150	25.4	22				
ADKT-I-R/L-3232-4-T25	●	●	32	32	170	32.4	25				
ADKT-I-R/L-2020-5-T20	●	●	20	20	125	20.5	20	DGN / GRP - 5			
ADKT-I-R/L-2525-5-T12	●	●	25	25	150	25.5	12				
ADKT-I-R/L-2525-5-T25	●	●	25	25	150	25.5	25	GRP - 3			
ADKT-IG-R/L-1616-3-T18	●	○	16	16	125	16.3	18				
ADKT-IG-R/L-2020-3-T12	●	●	20	20	125	20.3	12				
ADKT-IG-R/L-2020-3-R20	●	●	20	20	125	20.3	20				
ADKT-IG-R/L-2525-3-T12	●	●	25	25	150	25.3	12				
ADKT-IG-R/L-2525-3-T22	●	●	25	25	150	25.3	22	GIM / GIP - 2	AKV-02-M6x22	ABPL-01	AAL-03-3
ADKT-IGI-R/L-2020-2-T15	●	●	20	20	125	20.3	15				
ADKT-IGI-R/L-2525-2-T15	●	●	25	25	150	25.3	15	GIM / GIP - 3			
ADKT-IGI-R/L-1616-3-T15	●	●	16	16	125	16.3	15				
ADKT-IGI-R/L-2020-3-T20	●	●	20	20	125	20.3	20				
ADKT-IGI-R/L-2525-3-T19	●	●	25	25	150	25.3	9	GIM / GIP - 4			
ADKT-IGI-R/L-2525-3-T22	●	●	25	25	150	25.3	22				
ADKT-IGI-R/L-2525-4-T22	●	●	25	25	150	25.4	22	GIM / GIP - 5	2004-M8x1x20	-	AAL-05-4
ADKT-IGI-R/L-2525-5-T25	●	●	25	25	150	25.5	25				
ADKT-IGI-R/L-2525-8-T30	●	○	25	25	150	25.8	30	GIM / GIP - 8			
ADKT-IGTN-R/L-2525-5-T25	●	●	25	25	150	25.6	25	GTN - 5			
ADKT-IDC-R/L-2525-3-T21	●	○	25	25	150	25.4	21	DCE - 3			

R: Sağ / Right / Правый L: Sol / Left / Левый

● Stokta / In Stock / В наличии ○ Stokta Yok / Non Stock Item / Нет в наличии
ISCR Ucuna Uygunudur. / Compatible with ISCR Insert. / Под пластину ISCR.

Sipariş Örneği/Ordering Example/Образец заказа

1 ad./pcs./шт. ADKT-I-R-1212-2-T15

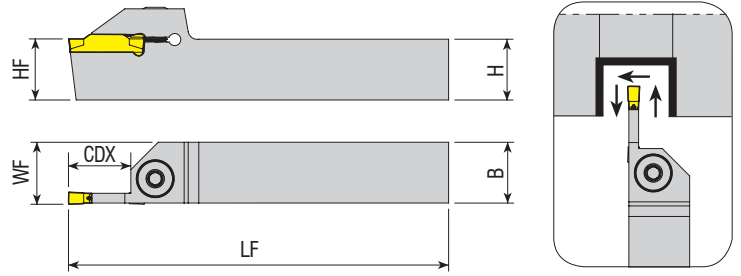

Takım Kodu Ordering Code Код для заказа	Stok Stock Наличие		Takım Ölçüleri (mm) Dimension (mm) Размеры (мм)					Kesici Uç Insert Пластина	Yedek Parçaları / Spare Parts / Запасные части					
	R	L	HF=H	B	LF	WF	CDX		Sıkma Vidası Screw Зажимной винт	Pul Stamp Шайба	Anahtar Allen Key Ключ			
ADKT-123-R/L-1212-1.5-R15	●	●	12	12	100	12.2	15	123 - 1.5	AKV-02-M6x22	ABPL-01	AAL-03-3			
ADKT-123-R/L-1616-1.5-R15	●	●	16	16	125	16.2	15							
ADKT-123-R/L-1616-2-T15	●	●	16	16	125	16.2	15							
ADKT-123-R/L-2020-2-T8	●	○	20	20	125	20.2	8	123 - 2						
ADKT-123-R/L-2020-2-T15	●	●	20	20	125	20.2	15							
ADKT-123-R/L-2525-2-T8	●	●	25	25	150	25.2	8							
ADKT-123-R/L-2525-2-T15	●	●	25	25	150	25.2	15							
ADKT-123-R/L-3232-2-T15	●	●	32	32	170	32.2	15	123 - 3				2004-M8x1x20	-	AAL-05-4
ADKT-123-R/L-1616-3-T10	●	●	16	16	125	16.3	10							
ADKT-123-R/L-1616-3-T15	●	●	16	16	125	16.3	15							
ADKT-123-R/L-2020-3-T10	●	●	20	20	125	20.3	10							
ADKT-123-R/L-2020-3-T15	●	●	20	20	125	20.3	15							
ADKT-123-R/L-2020-3-T20	●	●	20	20	125	20.3	20							
ADKT-123-R/L-2525-3-T10	●	●	25	25	150	25.3	10							
ADKT-123-R/L-2525-3-T15	●	●	25	25	150	25.3	15							
ADKT-123-R/L-2525-3-T22	●	●	25	25	150	25.3	22							
ADKT-123-R/L-2020-4-T20	●	●	20	20	125	20.4	20		123 - 4					
ADKT-123-R/L-2525-4-T13	●	●	25	25	150	25.4	13							
ADKT-123-R/L-2525-4-T22	●	●	25	25	150	25.4	22							
ADKT-123-R/L-3232-4-T25	●	●	32	32	170	32.4	25							
ADKT-123-R/L-2020-5-T20	●	●	20	20	125	20.5	20	123 - 5						
ADKT-123-R/L-2525-5-T25	●	●	25	25	150	25.5	25							
ADKT-123-R/L-3232-6-T15	●	●	32	32	170	32.5	15	123 - 6						

R: Sağ / Right / Правый L: Sol / Left / Левый
● Stokta / In Stock / В наличии ○ Stokta Yok / Non Stock Item / Нет в наличии
SNDVK Ucuna Uygundur. / Compatible with SNDVK Insert. / Под пластину SNDVK.

Sipariş Örneği/Ordering Example/Образец заказа
1 ad./pcs./шт. ADKT-123-R-1212-1.5-R15

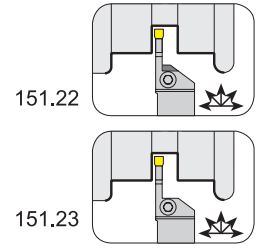
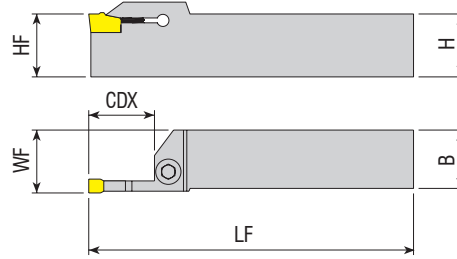

Takım Kodu Ordering Code Код для заказа	Stok Stock Наличие		Takım Ölçüleri (mm) Dimension (mm) Размеры (мм)				Kesici Uç Insert Пластина	Yedek Parçaları / Spare Parts / Запасные части			
	R	L	HF=H	B	LF	WF		CDX	Sıkma Vidası Screw Зажимной винт	Pul Stamp Шайба	Anahtar Allen Key Ключ
ADKT-151.22-R/L-1616-2-T15	●	●	16	16	125	16.3	15	151.2 - 2	AKV-02-M6x22	ABPL-01	AAL-03-3
ADKT-151.22-R/L-2020-2-T15	●	●	20	20	125	20.3	15				
ADKT-151.22-R/L-2525-2-T15	●	●	25	25	150	25.3	15				
ADKT-151.22-R/L-1616-3-T15	●	●	16	16	125	16.4	15	151.2 - 3	2004-M8x1x20	-	AAL-05-4
ADKT-151.22-R/L-2020-3-T20	●	●	20	20	125	20.4	20				
ADKT-151.22-R/L-2525-3-T22	●	●	25	25	150	25.4	22				
ADKT-151.22-R/L-1616-4-T15	●	●	16	16	125	16.4	15	151.2 - 4	2004-M8x1x20	-	AAL-05-4
ADKT-151.22-R/L-2020-4-T20	●	●	20	20	125	20.4	20				
ADKT-151.22-R/L-2525-4-T22	●	●	25	25	150	25.4	22				
ADKT-151.22-R/L-2020-5-T20	●	●	20	20	125	20.5	20	151.2 - 5	2004-M8x1x20	-	AAL-05-4
ADKT-151.22-R/L-2525-5-T25	●	●	25	25	150	25.5	25				
ADKT-151.23-R/L-1616-2-T15	●	●	16	16	125	16.3	15				
ADKT-151.23-R/L-2020-2-T15	●	●	20	20	125	20.3	15				
ADKT-151.23-R/L-2525-2-T15	●	●	25	25	150	25.3	15				
ADKT-151.23-R/L-1616-2.5-T15	●	●	16	16	125	16.3	15	151.2 - 2.5	2004-M8x1x20	-	AAL-05-4
ADKT-151.23-R/L-2020-2.5-T15	●	●	20	20	125	20.3	15				
ADKT-151.23-R/L-2525-2.5-T15	●	●	25	25	150	25.3	15				
ADKT-151.23-R/L-1212-3-T15	●	●	12	12	100	16.4	15	151.2 - 3	2004-M8x1x20	-	AAL-05-4
ADKT-151.23-R/L-1616-3-T15	●	●	16	16	125	16.4	15				
ADKT-151.23-R/L-2020-3-T20	●	●	20	20	125	20.4	20				
ADKT-151.23-R/L-2525-3-T20	●	●	25	25	150	25.4	20	151.2 - 4	2004-M8x1x20	-	AAL-05-4
ADKT-151.23-R/L-2525-3-T22	●	●	25	25	150	25.4	22				
ADKT-151.23-R/L-1616-4-T15	●	●	16	16	125	16.4	15				
ADKT-151.23-R/L-2020-4-T20	●	●	20	20	125	20.4	20	151.2 - 5	2004-M8x1x20	-	AAL-05-4
ADKT-151.23-R/L-2525-4-T22	●	●	25	25	150	25.4	22				
ADKT-151.23-R/L-2020-5-T20	●	●	20	20	125	20.5	20				
ADKT-151.23-R/L-2525-5-T25	●	●	25	25	150	25.5	25				

R: Sağ / Right / Правый L: Sol / Left / Левый
● Stokta / In Stock / В наличии ○ Stokta Yok / Non Stock Item / Нет в наличии
SNDVK Ucuна Uyğundur. / Compatible with SNDVK Insert. / Под пластину SNDVK.

Sipariş Örneği/Ordering Example/Образец заказа
1 ad./pcs./шт. ADKT-151.22-R-1616-2-T15

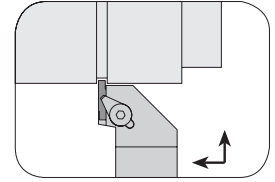
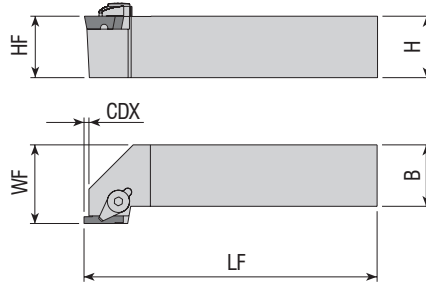

Takım Kodu Ordering Code Код для заказа	Stok Stock Наличие		Takım Ölçüleri (mm) Dimension (mm) Размеры (мм)				Kesici Uç Insert Пластина	Yedek Parçaları / Spare Parts / Запасные части				
	R	L	HF=H	B	LF	WF		CDX	Baskı Parçası Wedge Clamp Spannspratze	Sıkma Vidası Screw Зажимной винт	Pul Stamp Шайба	Anahtar Allen Key Ключ
ADKT-154.91-R/L-2020-3-T4	●	●	20	20	125	25	4	154.91 - 3	ACK-03	AKV-07-M6x22	APM-06	AAL-03-3
ADKT-154.91-R/L-2525-3-T4	●	●	25	25	150	30.5	4					
ADKT-154.91-R/L-2020-5-T5	●	●	20	20	125	25	5	154.91 - 5	ACK-03	AKV-07-M6x22	APM-06	AAL-03-3
ADKT-154.91-R/L-2525-5-T5	●	●	25	25	150	30.5	5					

SNDVK Ucuna Uygundur. / Compatible with SNDVK Insert. / Под пластину SNDVK.

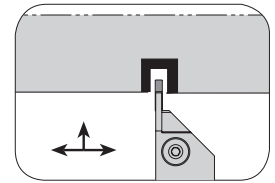
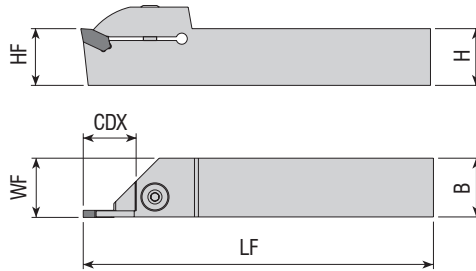

Takım Kodu Ordering Code Код для заказа	Stok Stock Наличие		Takım Ölçüleri (mm) Dimension (mm) Размеры (мм)				Kesici Uç Insert Пластина	Yedek Parçaları / Spare Parts / Запасные части			
	R	L	HF=H	B	LF	WF		CDX	Sıkma Vidası Screw Зажимной винт	Pul Stamp Шайба	Anahtar Allen Key Ключ
ADKT-ARN-R/L-2020-2-T15	●	●	20	20	125	20.3	15	LOMR. - 2	AKV-02-M6x22	ABPL-01	AAL-03-3
ADKT-ARN-R/L-2525-2-T15	●	●	25	25	150	25.3	15				
ADKT-ARN-R/L-2020-3-T20	●	●	20	20	125	20.4	20	LOMR. - 3	2004-M8x1x20	-	AAL-05-4
ADKT-ARN-R/L-2525-3-T22	●	●	25	25	150	25.4	22				

R: Sağ / Right / Правый L: Sol / Left / Левый

● Stokta / In Stock / В наличии ○ Stokta Yok / Non Stock Item / Нет в наличии

ARN Ucuna Uygundur. / Compatible with ARN Insert. / Под пластину ARN

Sipariş Örneği/Ordering Example/Образец заказа
1 ad./pcs./шт. ADKT-154.91-R-2020-3-T4

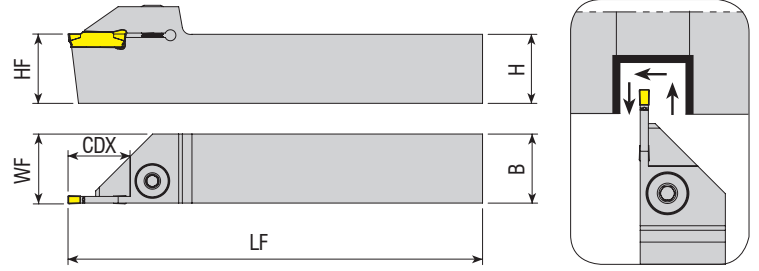

Takım Kodu Ordering Code Код для заказа	Stok Stock Наличие		Takım Ölçüleri (mm) Dimension (mm) Размеры (мм)					Kesici Uç Insert Пластина	Yedek Parçaları / Spare Parts / Залпасные части			
	R	L	HF=H	B	LF	WF	CDX		Sıkma Vidası Screw Зажимной винт	Pul Stamp Шайба	Anahtar Allen Key Ключ	
ADKT-TD-R/L-1212-2-T15	●	●	12	12	100	12.2	15	TD. - 2	AKV-02-M6x22	ABPL-01	AAL-03-3	
ADKT-TD-R/L-1616-2-T8	●	●	16	16	125	16.2	8					
ADKT-TD-R/L-1616-2-T15	●	●	16	16	125	16.2	15					
ADKT-TD-R/L-2020-2-T9	●	○	20	20	125	20.2	9					
ADKT-TD-R/L-2020-2-T15	●	●	20	20	125	20.2	15					
ADKT-TD-R/L-2020-2-T17	●	○	20	20	125	20.2	17					
ADKT-TD-R/L-2020-2-T20	●	○	20	20	125	20.2	20					
ADKT-TD-R/L-2525-2-T8	●	●	25	25	150	25.2	8					
ADKT-TD-R/L-2525-2-T17	●	●	25	25	150	25.2	17					
ADKT-TD-R/L-1212-3-T15	●	●	12	12	100	12.4	15					TD. - 3
ADKT-TD-R/L-1616-3-T15	●	●	16	16	125	16.4	15					
ADKT-TD-R/L-2020-3-T12	●	●	20	20	125	20.4	12					
ADKT-TD-R/L-2020-3-T20	●	●	20	20	125	20.4	20					
ADKT-TD-R/L-2020-3-T25	●	○	20	20	125	20.4	25					
ADKT-TD-R/L-2020-3-T30	●	●	20	20	125	20.4	30					
ADKT-TD-R/L-2525-3-T9	●	●	25	25	150	25.4	9					
ADKT-TD-R/L-2525-3-T12	●	●	25	25	150	25.4	12					
ADKT-TD-R/L-2525-3-T22	●	●	25	25	150	25.4	22					
ADKT-TD-R/L-2525-3-T25	●	●	25	25	150	25.4	25					
ADKT-TD-R/L-2525-3-T30	●	●	25	25	150	25.4	30					
ADKT-TD-R/L-3232-3-T25	●	○	32	32	170	32.4	25	TD. - 4				
ADKT-TD-R/L-2525-4-T10	●	●	25	25	150	25.5	10					
ADKT-TD-R/L-2525-4-T15	●	●	25	25	150	25.5	15					
ADKT-TD-R/L-2525-4-T22	●	●	25	25	150	25.5	22					
ADKT-TD-R/L-2525-4-T25	●	○	25	25	150	25.5	25					
ADKT-TD-R/L-2525-4-T30	●	○	25	25	150	25.5	30	TD. - 5				
ADKT-TD-R/L-2525-5-T25	●	●	25	25	150	25.5	25					

R: Sağ / Right / Правый L: Sol / Left / Левый
● Stokta / In Stock / В наличии ○ Stokta Yok / Non Stock Item / Нет в наличии
TGTC Ucuna Uygunudur. / Compatible with TGTC Insert. / Под пластину TGTC.

Sipariş Örneği/Ordering Example/Образец заказа
1 ad./pcs./шт. ADKT-TD-R-1212-2-T15

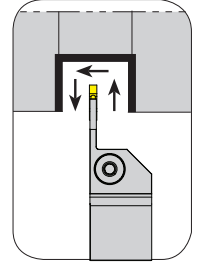
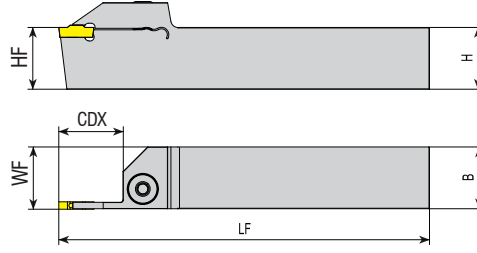

Takım Kodu
Ordering Code
Код для заказа

Takım Kodu Ordering Code Код для заказа	Stok Stock Наличие		Takım Ölçüleri (mm) Dimension (mm) Размеры (мм)				Kesici Uç Insert Пластина	Yedek Parçaları / Spare Parts / Запасные части			
	R	L	HF=H	B	LF	WF		CDX	Sıkma Vidası Screw Зажимной винт	Pul Stamp Шайба	Anahtar Allen Key Ключ
ADKT-RD-R/L-1616-2-T17	●	○	16	16	125	16,2	17	RD. - 2	AKV-02-M6x22	ABPL-01	AAL-03-3
ADKT-RD-R/L-2020-2-T17	●	○	20	20	125	20,2	17				
ADKT-RD-R/L-2525-2-T17	●	●	25	25	150	25,2	17				
ADKT-RD-R/L-1616-3-T20	●	○	16	16	125	16,3	20	RD. - 3	2004-M8x1x20	-	AAL-05-4
ADKT-RD-R/L-2020-3-T25	●	○	20	20	125	20,3	25				
ADKT-RD-R/L-2525-3-T25	●	●	25	25	150	25,3	25				
ADKT-RD-R/L-2020-4-T30	●	○	20	20	125	20,5	30	RD. - 4	2004-M8x1x20	-	AAL-05-4
ADKT-RD-R/L-2525-4-T30	●	●	25	25	150	25,5	30				

TGTC Ucuna Uygundur. / Compatible with TGTC Insert. / Под пластину TGTC.

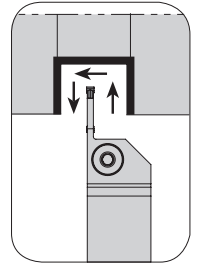
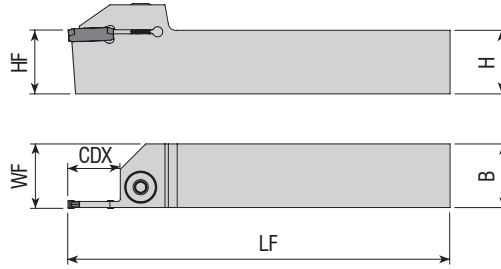

Takım Kodu
Ordering Code
Код для заказа

Takım Kodu Ordering Code Код для заказа	Stok Stock Наличие		Takım Ölçüleri (mm) Dimension (mm) Размеры (мм)				Kesici Uç Insert Пластина	Yedek Parçaları / Spare Parts / Запасные части			
	R	L	HF=H	B	LF	WF		CDX	Sıkma Vidası Screw Зажимной винт	Pul Stamp Шайба	Anahtar Allen Key Ключ
ADKT-LGC-R/L-1616-2-D40	●	●	16	16	125	16,2	20	GCTX - 2	AKV-02-M6x22	ABPL-01	AAL-03-3
ADKT-LGC-R/L-2020-2-D40	●	●	20	20	125	20,2	20				
ADKT-LGC-R/L-2525-2-D40	●	●	25	25	150	25,2	20				
ADKT-LGC-R/L-1616-3-T20	●	●	16	16	125	16,3	20	GCTX - 3	2004-M8x1x20	-	AAL-05-4
ADKT-LGC-R/L-2020-3-T20	●	●	20	20	125	20,3	20				
ADKT-LGC-R/L-2525-3-T20	●	●	25	25	150	25,3	20				

R: Sağ / Right / Правый L: Sol / Left / Левый
● Stokta / In Stock / В наличии ○ Stokta Yok / Non Stock Item / Нет в наличии
LMN Ucuna Uygundur. / Compatible with LMN Insert. / Под пластину LMN

Sipariş Örneği/Ordering Example/Образец заказа
1 ad./pcs./шт. ADKT-RD-R-1616-2-T17

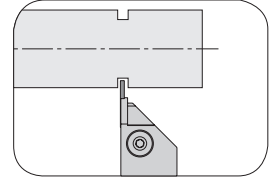
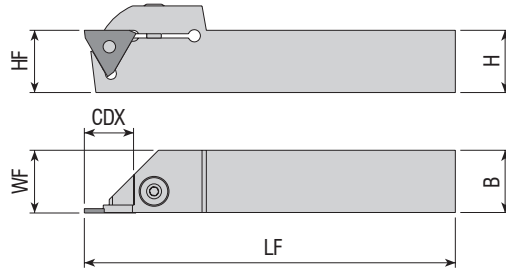

Takım Kodu Ordering Code Код для заказа	Stok Stock Наличие		Takım Ölçüleri (mm) Dimension (mm) Размеры (мм)				Kesici Uç Insert Пластина	Yedek Parçaları / Spare Parts / Запасные части				
	R	L	HF=H	B	LF	WF	CDX	Sıkma Vidası Screw Зажимной винт	Baskı Pabucu Wedge Clamp Прижим	Sekman Ring Кольцо	Anahtar Allen Key Ключ	
ADKT-H22-R/L-1616-(0.5-2)-T4	●	●	16	16	125	16.2	4					
ADKT-H22-R/L-2020-(0.5-2)-T4	●	●	20	20	125	20.2	4	S312 - (0.5-2)	AKV-29-M6x29	AKK-04	AS-01	AAL-03-3
ADKT-H22-R/L-2525-(0.5-2)-T4	●	●	25	25	150	25.2	4					

HRN Ucuna Uygundur. / Compatible with HRN Insert. / Под пластину HRN

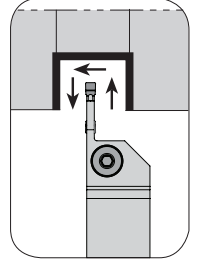
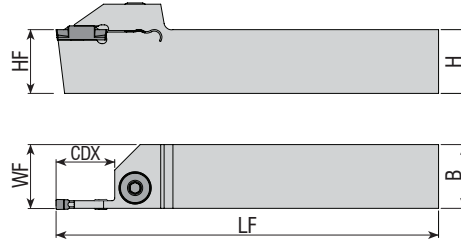

Takım Kodu Ordering Code Код для заказа	Stok Stock Наличие		Takım Ölçüleri (mm) Dimension (mm) Размеры (мм)				Kesici Uç Insert Пластина	Yedek Parçaları / Spare Parts / Запасные части			
	R	L	HF=H	B	LF	WF	CDX	Sıkma Vidası Screw Зажимной винт	Pul Stamp Шайба	Anahtar Allen Key Ключ	
ADKT-TG-R/L-1616-2-R17	●	○	16	16	125	16.2	17	DGM2-020	AKV-02-M6x22	ABPL-01	AAL-03-3
ADKT-TG-R/L-2020-2-R8	●	○	20	20	125	20.2	8				
ADKT-TG-R/L-2020-2-R12	●	○	20	20	125	20.2	12				
ADKT-TG-R/L-2020-2-R17	●	○	20	20	125	20.2	17	DGM3-020	2004-M8x1x20	-	AAL-05-4
ADKT-TG-R/L-2525-2-R12	●	○	25	25	150	25.2	12				
ADKT-TG-R/L-2525-2-R17	●	○	25	25	150	25.2	17				
ADKT-TG-R/L-1616-3-T20	●	○	16	16	125	16.3	20	DGM4-030	2004-M8x1x20	-	AAL-05-4
ADKT-TG-R/L-2020-3-T12	●	○	20	20	125	20.3	12				
ADKT-TG-R/L-2020-3-T20	●	○	20	20	125	20.3	20				
ADKT-TG-R/L-2525-3-T9	●	○	25	25	150	25.3	9	DGM5-030	2004-M8x1x20	-	AAL-05-4
ADKT-TG-R/L-2525-3-T20	●	○	25	25	150	25.3	20				
ADKT-TG-R/L-2525-3-R25	●	○	25	25	150	25.3	25				
ADKT-TG-R/L-2525-4-T15	●	○	25	25	150	25.5	15	DGM5-030	2004-M8x1x20	-	AAL-05-4
ADKT-TG-R/L-2525-4-T20	●	○	25	25	150	25.5	20				
ADKT-TG-R/L-2525-4-T25	●	○	25	25	150	25.5	25				
ADKT-TG-R/L-2525-5-T12	●	○	25	25	150	25.5	12	DGM5-030	2004-M8x1x20	-	AAL-05-4
ADKT-TG-R/L-2525-5-T25	●	○	25	25	150	25.5	25				
ADKT-TG-R/L-2525-5-T32	●	○	25	25	150	25.5	32				

R: Sağ / Right / Правый L: Sol / Left / Левый

● Stokta / In Stock / В наличии ○ Stokta Yok / Non Stock Item / Нет в наличии

TNGLY Ucuna Uygundur. / Compatible with TNGLY Insert. / Под пластину TNGLY

Sipariş Örneği/Ordering Example/Образец заказа

1 ad./pcs./шт. ADKT-H22-R-1616-(0.5-2)T4



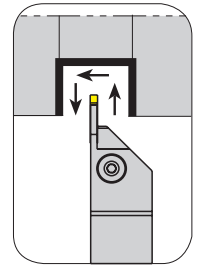
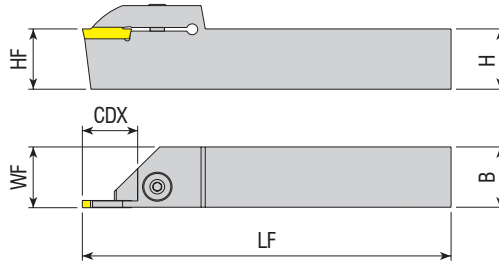

Takım Kodu Ordering Code Код для заказа	Stok Stock Наличие		Takım Ölçüleri (mm) Dimension (mm) Размеры (мм)				Kesici Uç Insert Пластина	Yedek Parçaları / Spare Parts / Запасные части			
	R	L	HF=H	B	LF	WF		CDX	Sıkma Vidası Screw Зажимной винт	Pul Stamp Шайба	Anahtar Allen Key Ключ
ADKT-WGX16-R/L-2020-2-R16	●	○	20	20	125	20.2	16	GX16. - 2	AKV-02-M6x22	ABPL-01	AAL-03-3
ADKT-WGX16-R/L-2525-2-R16	●	○	25	25	150	25.2	16				
ADKT-WGX24-R/L-2020-3-T20	●	●	20	20	125	20.4	20	GX24. - 3	2004-M8x1x20	-	AAL-05-4
ADKT-WGX24-R/L-2525-3-T12	●	●	25	25	150	25.4	12				
ADKT-WGX24-R/L-2525-3-T22	●	●	25	25	150	25.4	22				
ADKT-WGX24-R/L-3232-3-T22	●	○	32	32	170	32.4	22				
ADKT-WGX24-R/L-2525-4-T22	●	●	25	25	150	25.5	22				
ADKT-WGX24-R/L-2525-5-T25	●	●	25	25	150	25.5	25	GX24. - 5			
ADKT-WGX24-R/L-3232-5-T25	●	●	32	32	170	32.5	25				

WLTR Ucuna Uygun. / Compatible with WLTR Insert. / Под пластину WLTR

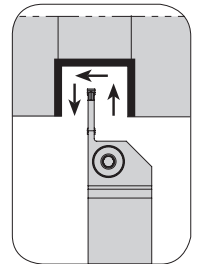
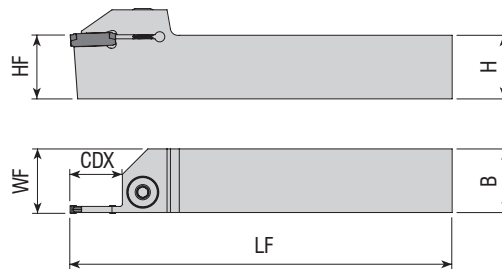

Takım Kodu Ordering Code Код для заказа	Stok Stock Наличие		Takım Ölçüleri (mm) Dimension (mm) Размеры (мм)				Kesici Uç Insert Пластина	Yedek Parçaları / Spare Parts / Запасные части			
	R	L	HF=H	B	LF	WF		CDX	Sıkma Vidası Screw Зажимной винт	Pul Stamp Шайба	Anahtar Allen Key Ключ
ADKT-GP-R/L-2020-2-T15	●	●	20	20	125	20.2	15	GP - 2	AKV-02-M6x22	ABPL-01	AAL-03-3
ADKT-GP-R/L-2525-2-T15	●	●	25	25	150	25.2	15				
ADKT-GP-R/L-2020-3-T20	●	●	20	20	125	20.3	20	GP - 3	2004-M8x1x20	-	AAL-05-4
ADKT-GP-R/L-2525-3-T22	●	●	25	25	150	25.3	22				
ADKT-GP-R/L-2525-4-T22	●	●	25	25	150	25.4	22				
ADKT-GP-R/L-2525-5-T25	●	●	25	25	150	25.5	25				
ADKT-GP-R/L-2525-5-T25	●	●	25	25	150	25.5	25				

R: Sağ / Right / Правый L: Sol / Left / Левый
● Stokta / In Stock / В наличии ○ Stokta Yok / Non Stock Item / Нет в наличии
PLBT Ucuna Uygun. / Compatible with PLBT Insert. / Под пластину PLBT.

Sipariş Örneği/Ordering Example/Образец заказа
1 ad./pcs./шт. ADKT-WGX16-R-2020-2-R16

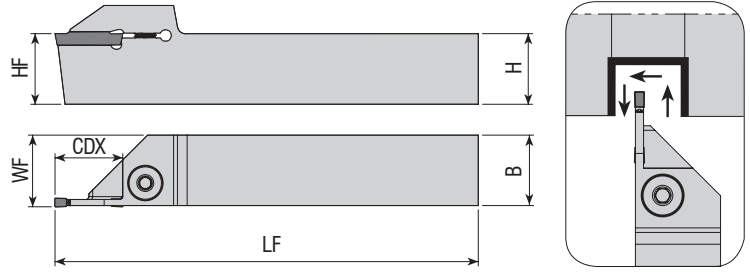

Takım Kodu Ordering Code Код для заказа	Stok Stock Наличие		Takım Ölçüleri (mm) Dimension (mm) Размеры (мм)				Kesici Uç Insert Пластина	Yedek Parçaları / Spare Parts / Запасные части			
	R	L	HF=H	B	LF	WF		CDX	Sıkma Vidası Screw Зажимной винт	Pul Stamp Шайба	Anahtar Allen Key Ключ
ADKT-CD-R/L-2020-3-R20	●	○	20	20	125	20.3	20	GX24 0300	2004-M8x1x20	-	AAL-05-4
ADKT-CD-R/L-2525-3-R23	●	○	25	25	150	25.3	23				

CRTZT Ucuna Uygun. / Compatible with CRTZT Insert. / Под пластину CRTZT

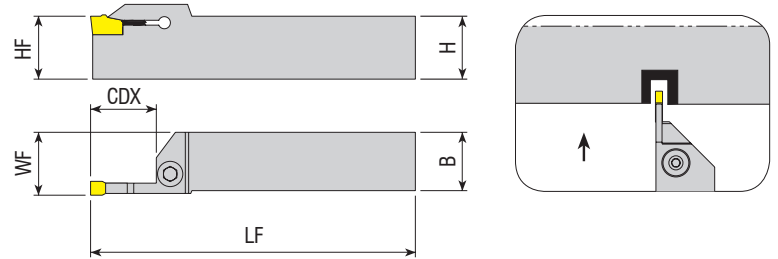

Takım Kodu Ordering Code Код для заказа	Stok Stock Наличие		Takım Ölçüleri (mm) Dimension (mm) Размеры (мм)				Kesici Uç Insert Пластина	Yedek Parçaları / Spare Parts / Запасные части			
	R	L	HF=H	B	LF	WF		CDX	Sıkma Vidası Screw Зажимной винт	Pul Stamp Шайба	Anahtar Allen Key Ключ
ADKT-SWC-R/L-2020-2-T25	●	○	20	20	125	20.3	25	WCF - 2	AKV-02-M6x22	ABPL-01	AAL-03-3
ADKT-SWC-R/L-2020-3-T25	●	○	20	20	125	20.4	25				

R: Sağ / Right / Правый L: Sol / Left / Левый
● Stokta / In Stock / В наличии ○ Stokta Yok / Non Stock Item / Нет в наличии
SMTM Ucuna Uygun. / Compatible with SMTM Insert. / Под пластину SMTM.

Sipariş Örneği/Ordering Example/Образец заказа
1 ad./pcs./шт. ADKT-CD-R-2020-3-R20

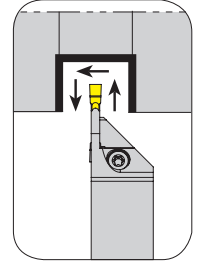
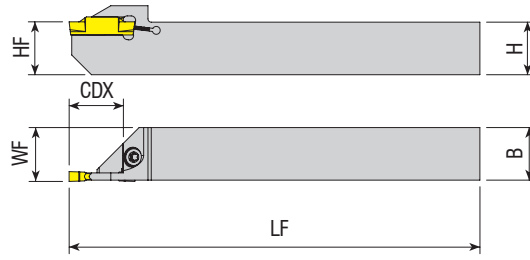

Takım Kodu Ordering Code Код для заказа	Stok Stock Наличие		Takım Ölçüleri (mm) Dimension (mm) Размеры (мм)					Kesici Uç Insert Пластина	Yedek Parçaları / Spare Parts / Запасные части		
	R	L	HF=H	B	LF	WF	CDX		Sıkma Vidası Screw Зажимной винт	Pul Stamp Шайба	Anahtar Allen Key Ключ
ADKT-TD-R/L-1212-2-T12-K-S	●	●	12	12	125	12.2	12	TD - 2	4015-M4x11	-	80-T15
ADKT-TD-R/L-1616-2-T16-K-S	●	●	16	16	125	16.2	16				
ADKT-TD-R/L-1212-3-T12-K-S	●	●	12	12	125	12.3	12	TD - 3	4015-M4x11	-	80-T15
ADKT-TD-R/L-1616-3-T16-K-S	●	●	16	16	125	16.3	16				

TGTC Ucuna Uygunudur. / Compatible with TGTC Insert. / Под пластину TGTC.

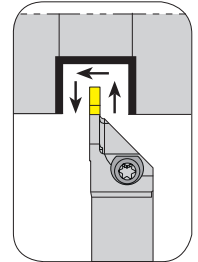
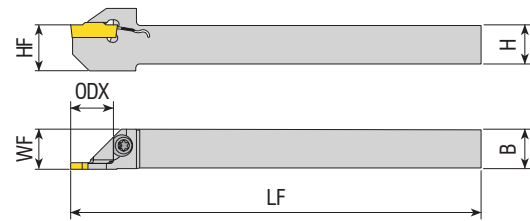

Takım Kodu Ordering Code Код для заказа	Stok Stock Наличие		Takım Ölçüleri (mm) Dimension (mm) Размеры (мм)					Kesici Uç Insert Пластина	Yedek Parçaları / Spare Parts / Запасные части		
	R	L	HF=H	B	LF	WF	CDX		Sıkma Vidası Screw Зажимной винт	Pul Stamp Шайба	Tork Anahtar Torx Key Торх Ключ
ADKT-RD-R/L-1212-2-T12-K-S	●	●	12	12	125	12.2	12	RD - 2	4015-M4x11	-	80-T15
ADKT-RD-R/L-1616-2-T17-K-S	○	●	16	16	125	16.2	17				
ADKT-RD-R/L-1212-3-T12-K-S	●	●	12	12	125	12.2	12	RD - 3	4015-M4x11	-	80-T15

R: Sağ / Right / Правый L: Sol / Left / Левый
● Stokta / In Stock / В наличии ○ Stokta Yok / Non Stock Item / Нет в наличии
TGTC Ucuna Uygunudur. / Compatible with TGTC Insert. / Под пластину TGTC.

Sipariş Örneği/Ordering Example/Образец заказа
1 ad./pcs./шт. ADKT-TD-R-1212-2-T12-K-S

DIŞ ÇAP KANAL AÇMA İSVİÇRE TİPİ KAYAR OTOMAT MAKİNA TAKIMLARI

EXTERNAL GROOVING TOOLHOLDERS FOR SWISS TYPE SLIDING AUTOMATIC LATHES

ДЕРЖАВКИ ДЛЯ ОБРАБОТКИ НАРУЖНЫХ КАНАВОК ДЛЯ ТОКАРНЫХ СТАНКОВ ШВЕЙЦАРСКОГО ТИПА

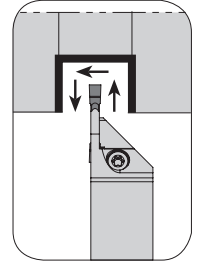
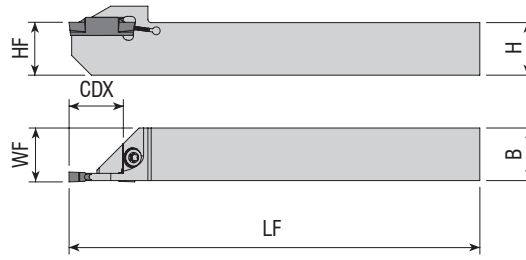

Takım Kodu Ordering Code Код для заказа	Stok Stock Наличие		Takım Ölçüleri (mm) Dimension (mm) Размеры (мм)					Kesici Uç Insert Пластина	Yedek Parçaları / Spare Parts / Запасные части		
	R	L	HF=H	B	LF	WF	CDX		Sıkma Vidası Screw Зажимной винт	Pul Stamp Шайба	Anahtar Allen Key Ключ
ADKT-ZCC2-R/L-1010-2-T12-K-S	●	●	10	10	125	10.2	12	Z.BD - 2	4015-M4x11	-	80-T15
ADKT-ZCC2-R/L-1212-2-T12-K-S	●	●	12	12	125	12.2	12				
ADKT-ZCC2-R/L-1616-2-R16-K-S	●	●	16	16	125	16.2	16	Z.FD - 3			
ADKT-ZCC2-R/L-1212-3-T12-K-S	●	●	12	12	125	12.3	12				

ZCC Ucuna Uygundur. / Compatiple with ZCC Insert. / Под пластину ZCC.

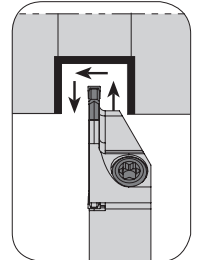
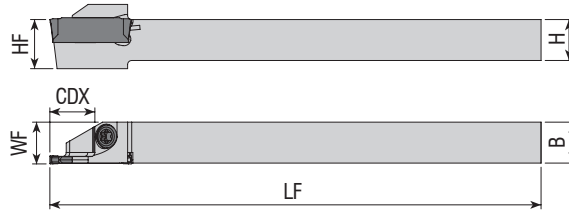

Takım Kodu Ordering Code Код для заказа	Stok Stock Наличие		Takım Ölçüleri (mm) Dimension (mm) Размеры (мм)					Kesici Uç Insert Пластина	Yedek Parçaları / Spare Parts / Запасные части		
	R	L	HF=H	B	LF	WF	CDX		Sıkma Vidası Screw Зажимной винт	Pul Stamp Шайба	Anahtar Allen Key Ключ
ADKT-I-R/L-0808-2-R10-S	●	●	08	08	100	8.2	10	DGN - 2	4015-M4x11	-	80-T15
ADKT-I-R/L-1010-2-R10-K-S	●	●	10	10	125	10.2	10				
ADKT-I-R/L-1212-2-R12-K-S	●	●	12	12	125	12.2	12	DGN - 3			
ADKT-I-R/L-1616-3-R16-K-S	●	●	16	16	125	16.3	16				

R: Sağ / Right / Правый L: Sol / Left / Левый

● Stokta / In Stock / В наличии ○ Stokta Yok / Non Stock Item / Нет в наличии

ISCR Ucuna Uygundur. / Compatiple with ISCR Insert. / Под пластину ISCR.

Sipariş Örneği/Ordering Example/Образец заказа

1 ad./pcs./шт. ADKT-ZCC2-R-1010-2-T12-K-S

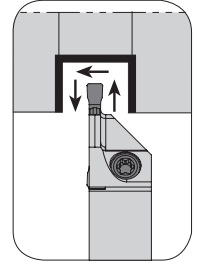
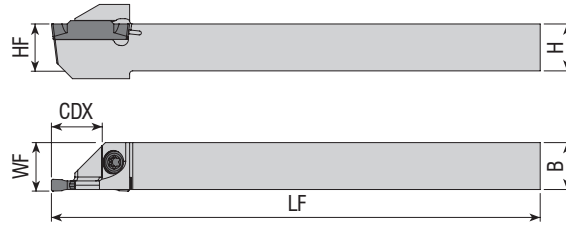

Takım Kodu Ordering Code Код для заказа	Stok Stock Наличие		Takım Ölçüleri (mm) Dimension (mm) Размеры (мм)				Kesici Uç Insert Пластина	Yedek Parçaları / Spare Parts / Запасные части			
	R	L	HF=H	B	LF	WF		CDX	Sıkma Vidası Screw Зажимной винт	Pul Stamp Шайба	Anahtar Allen Key Ключ
ADKT-KG-R/L-1212-2-R12-K-S	●	●	12	12	125	12.2	12	KG. - 2	4015-M4x11	-	80-T15
ADKT-KG-R/L-1616-2-R16-K-S	●	●	16	16	125	16.2	16				
ADKT-KG-R/L-1212-3-R12-K-S	●	●	12	12	125	12.3	12	KG. - 3	4015-M4x11	-	80-T15
ADKT-KG-R/L-1616-3-R16-K-S	●	●	16	16	125	16.3	16				

KRLY Ucuna Uygun. / Compatible with KRLY Insert. / Под пластину KRLY.

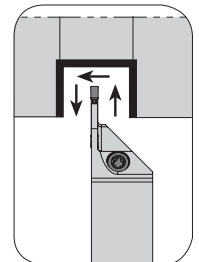
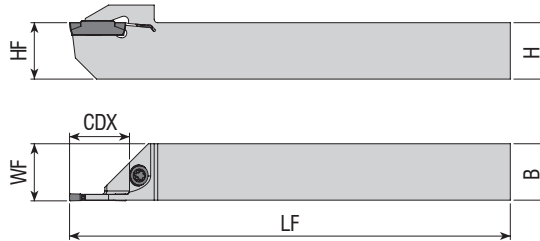

Takım Kodu Ordering Code Код для заказа	Stok Stock Наличие		Takım Ölçüleri (mm) Dimension (mm) Размеры (мм)				Kesici Uç Insert Пластина	Yedek Parçaları / Spare Parts / Запасные части			
	R	L	HF=H	B	LF	WF		CDX	Sıkma Vidası Screw Зажимной винт	Pul Stamp Шайба	Anahtar Allen Key Ключ
ADKT-K-R/L-1212-2-R12-K-S	●	●	12	12	125	12.20	12	MGM. - 2	4015-M4x11	-	80-T15
ADKT-K-R/L-1616-2-R16-K-S	●	●	16	16	125	16.20	16				
ADKT-K-R/L-1212-3-R12-K-S	●	●	12	12	125	12.30	12	MGM. - 3	4015-M4x11	-	80-T15
ADKT-K-R/L-1616-3-R16-K-S	●	●	16	16	125	16.30	16				

R: Sağ / Right / Правый L: Sol / Left / Левый

● Stokta / In Stock / В наличии ○ Stokta Yok / Non Stock Item / Нет в наличии

KRLY Ucuna Uygun. / Compatible with KRLY Insert. / Под пластину KRLY.

Sipariş Örneği/Ordering Example/Образец заказа

1 ad./pcs./шт. ADKT-KG-R-1212-2-R12-K-S

DIŞ ÇAP KANAL AÇMA İSVİÇRE TİPİ KAYAR OTOMAT MAKİNA TAKIMLARI

EXTERNAL GROOVING TOOLHOLDERS FOR SWISS TYPE SLIDING AUTOMATIC LATHES

ДЕРЖАВКИ ДЛЯ ОБРАБОТКИ НАРУЖНЫХ КАНАВOK ДЛЯ ТОКАРНЫХ СТАНКОВ ШВЕЙЦАРСКОГО ТИПА

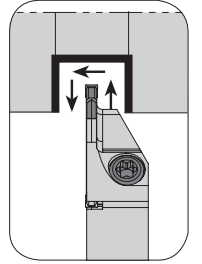
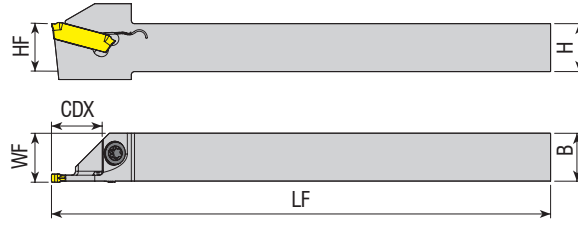

Takım Kodu Ordering Code Код для заказа	Stok Stock Наличие		Takım Ölçüleri (mm) Dimension (mm) Размеры (мм)				Kesici Uç Insert Пластина	Yedek Parçaları / Spare Parts / Запасные части			
	R	L	HF=H	B	LF	WF		CDX	Sıkma Vidası Screw Зажимной винт	Pul Stamp Шайба	Anahtar Allen Key Ключ
ADKT-WGX16-R/L-1212-2-R12-K-S	●	●	12	12	125	12.2	12	GX16. - 2	4015-M4x11	-	80-T15
ADKT-WGX16-R/L-1616-2-R16-K-S	●	○	16	16	125	16.2	16				
ADKT-WGX24-R/L-1616-3-R16-K-S	●	○	16	16	125	16.3	16	GX24. - 3			

WLTR Ucuna Uygundur. / Compatible with WLTR Insert. / Под пластину WLTR

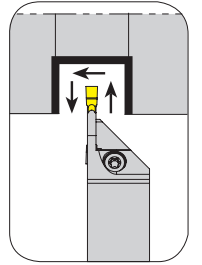
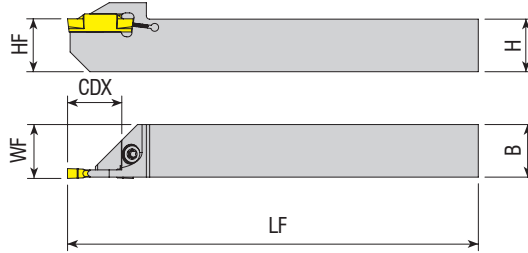

Takım Kodu Ordering Code Код для заказа	Stok Stock Наличие		Takım Ölçüleri (mm) Dimension (mm) Размеры (мм)				Kesici Uç Insert Пластина	Yedek Parçaları / Spare Parts / Запасные части			
	R	L	HF=H	B	LF	WF		CDX	Sıkma Vidası Screw Зажимной винт	Pul Stamp Шайба	Tork Anahtar Torx Key Торх Ключ
ADKT-TG-R/L-1212-2-R12-K-S	●	○	12	12	125	12.2	12	DGM2-020 DGM3-020	4015-M4x11	-	80-T15
ADKT-TG-R/L-1212-3-R12-K-S	●	○	12	12	125	12.3	12				

R: Sağ / Right / Правый L: Sol / Left / Левый

● Stokta / In Stock / В наличии ○ Stokta Yok / Non Stock Item / Нет в наличии

TNGLY Ucuna Uygundur. / Compatible with TNGLY Insert. / Под пластину TNGLY

Sipariş Örneği/Ordering Example/Образец заказа

1 ad./pcs./шт. ADKT-WGX16-R-1212-2-R12-K-S



www.akko.com.tr

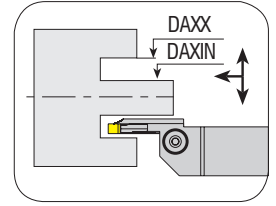
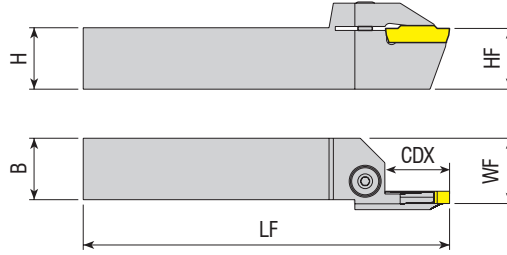

Takım Kodu
Ordering Code
Код для заказа

Takım Kodu Ordering Code Код для заказа	Stok Stock Наличие		Takım Ölçüleri (mm) Dimension (mm) Размеры (мм)							Kesici Uç Insert Пластина	Yedek Parçaları / Spare Parts / Запасные части		
	R	L	HF=H	B	LF	WF	CDX	DAXIN	DAXX	Sıkma Vidası Screw Зажимной винт	Pul Stamp Шайба	Anahtar Allen Key Ключ	
AAKT-K-R/L-2525-34-45-3-T17	●	●	25	25	150	26.5	17	34	45	MGM. - 3			
AAKT-K-R/L-2525-39-55-3-T17	●	●	25	25	150	26.5	17	39	55				
AAKT-K-R/L-2525-49-80-3-T17	●	●	25	25	150	26.5	17	49	80				
AAKT-K-R/L-2525-70-110-3-T17	●	●	25	25	150	26.5	17	70	110				
AAKT-K-R/L-2525-100-150-3-T17	●	●	25	25	150	26.5	17	100	150				
AAKT-K-R/L-2525-80-180-3-T32	●	●	25	25	150	26.5	32	80	180				
AAKT-K-R/L-2525-175-215-3-T22	●	●	25	25	150	26.5	22	175	215				
AAKT-K-R/L-2525-700-800-3-T17	●	●	25	25	150	26.5	17	700	800	MGM. - 4	2004-M8x1x20	-	AAL-05-4
AAKT-K-R/L-2525-50-85-4-T22	●	●	25	25	150	26.5	22	50	85				
AAKT-K-R/L-2525-70-110-4-T22	●	●	25	25	150	26.5	22	70	110				
AAKT-K-R/L-2525-100-150-4-T22	●	●	25	25	150	26.5	22	100	150				
AAKT-K-R/L-2525-80-180-4-T32	●	●	25	25	150	26.5	32	80	180				
AAKT-K-R/L-2525-180-800-4-T32	●	●	25	25	150	26.5	32	180	800				
AAKT-K-R/L-2525-70-110-5-T25	●	●	25	25	150	26.5	25	70	110				
AAKT-K-R/L-2525-100-150-5-T25	●	●	25	25	150	26.5	25	100	150				
AAKT-K-R/L-2525-80-180-5-T32	●	●	25	25	150	26.5	32	80	180				
AAKT-K-R/L-2525-140-200-5-T25	●	●	25	25	150	26.5	25	140	200				
AAKT-K-R/L-2525-180-800-5-T32	●	●	25	25	150	26.5	32	180	800				
AAKT-K-R/L-2525-60-100-6-T25	●	●	25	25	150	26.5	25	60	100				
AAKT-K-R/L-2525-60-100-6-T35	●	○	25	25	150	26.5	35	60	100	MGM. - 6			
AAKT-K-R/L-2525-100-200-6-T25	●	○	25	25	150	26.5	25	100	200				
AAKT-K-R/L-2525-100-200-6-T35	●	○	25	25	150	26.5	35	100	200				
AAKT-K-R/L-2525-100-200-6-T45	●	○	25	25	150	26.5	45	100	200				
AAKT-K-R/L-2525-140-300-6-T35	●	●	25	25	150	26.5	35	140	300	MGM. - 8			
AAKT-K-R/L-2525-140-300-8-T35	●	○	25	25	150	26.5	35	140	300				
AAKT-K-R/L-3232-140-350-8-T35	●	○	32	32	150	33.5	35	140	350				

R: Sağ / Right / Правый L: Sol / Left / Левый
● Stokta / In Stock / В наличии ○ Stokta Yok / Non Stock Item / Нет в наличии
KRLY Ucuna Uygunudur. / Compatible with KRLY Insert. / Под пластину KRLY.

Sipariş Örneği/Ordering Example/Образец заказа
1 ad./pcs./шт. AAKT-K-R-2525-34-45-3-T17

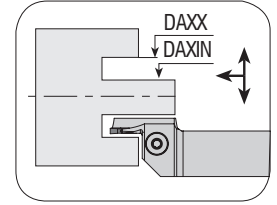
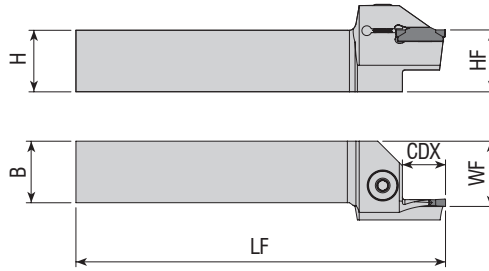

Takım Kodu
Ordering Code
Код для заказа

Takım Kodu Ordering Code Код для заказа	Takım Ölçüleri (mm) Dimension (mm) Размеры (мм)									Kesici Uç Insert Пластина	Yedek Parçaları / Spare Parts / Запасные части			
	R	L	HF=H	B	LF	WF	CDX	DAXIN	DAXX		Sıkma Vidası Screw Зажимной винт	Pul Stamp Шайба	Anahtar Allen Key Ключ	
AAKT-ZCC2-R/L-2525-140-180-2-T4	●	○	25	25	150	26.5	4	140	180	Z.BD - 2	2004-M8x1x20	-	AAL-05-4	
AAKT-ZCC2-R/L-2525-35-45-3-T17	●	●	25	25	150	26.5	17	35	45	Z.FD - 3				
AAKT-ZCC2-R/L-2525-39-55-3-T17	●	○	25	25	150	26.5	17	39	55					
AAKT-ZCC2-R/L-2525-49-80-3-T17	●	●	25	25	150	26.5	17	49	80					
AAKT-ZCC2-R/L-2525-70-110-3-T15	●	○	25	25	150	26.5	15	70	110					
AAKT-ZCC2-R/L-2525-70-110-3-T17	●	●	25	25	150	26.5	17	70	110					
AAKT-ZCC2-R/L-2525-100-150-3-T17	●	●	25	25	150	26.5	17	100	150					
AAKT-ZCC2-R/L-2525-40-60-4-T22	●	○	25	25	150	26.5	22	40	60	Z.GD - 4				
AAKT-ZCC2-R/L-2525-52-80-4-T22	●	●	25	25	150	26.5	22	52	80					
AAKT-ZCC2-R/L-2525-72-110-4-T22	●	●	25	25	150	26.5	22	72	110					
AAKT-ZCC2-R/L-2525-100-150-4-T22	●	●	25	25	150	26.5	22	100	150					
AAKT-ZCC2-R/L-2525-140-200-4-T22	●	●	25	25	150	26.5	22	140	200					
AAKT-ZCC2-R/L-2525-55-95-5-T25	●	○	25	25	150	26.5	25	55	95	Z.HD - 5				
AAKT-ZCC2-R/L-2525-85-140-5-T25	●	●	25	25	150	26.5	25	85	140					
AAKT-ZCC2-R/L-2525-130-200-5-T25	●	○	25	25	150	26.5	25	130	200					
AAKT-ZCC2-R/L-2525-190-400-5-T25	●	●	25	25	150	26.5	25	190	400					
AAKT-ZCC2-R/L-2525-190-400-5-T35	●	○	25	25	150	26.5	35	190	400					
AAKT-ZCC2-R/L-2525-200-500-5-T17	●	●	25	25	150	26.5	17	200	500					
AAKT-ZCC2-R/L-2525-60-110-6-T15	●	○	25	25	150	26.5	15	60	110	Z.KD - 6				

ZCC Ucuna Uygunudur. / Compatible with ZCC Insert. / Под пластину ZCC.

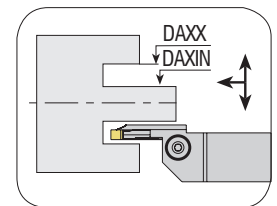
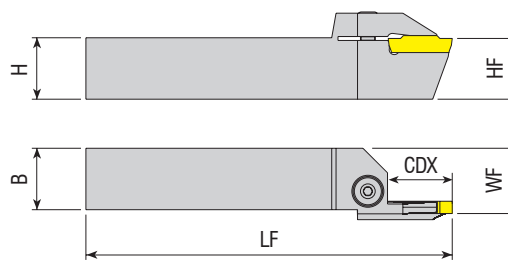

Takım Kodu Ordering Code Код для заказа	Stok Stock Наличие	Takım Ölçüleri (mm) Dimension (mm) Размеры (мм)									Kesici Uç Insert Пластина	Yedek Parçaları / Spare Parts / Запасные части			
		R	L	HF=H	B	LF	WF	CDX	DAXIN	DAXX		Sıkma Vidası Screw Зажимной винт	Pul Stamp Шайба	Anahtar Allen Key Ключ	
AAKT-KG-R/L-2525-44-70-4-T22	○	○	25	25	150	26.5	22	44	70	KG.. - 4	2004-M8x1x20	-	AAL-05-4		
AAKT-KG-R/L-2525-60-120-4-T22	○	○	25	25	150	26.5	22	60	120						
AAKT-KG-R/L-2525-112-200-4-T22	○	○	25	25	150	26.5	22	112	200						

R: Sağ / Right / Правый L: Sol / Left / Левый
● Stokta / In Stock / В наличии ○ Stokta Yok / Non Stock Item / Нет в наличии
KRLY Ucuna Uygunudur. / Compatible with KRLY Insert. / Под пластину KRLY.

Sipariş Örneği/Ordering Example/Образец заказа
1 ad./pcs./шт. AAKT-ZCC2-R-2525-140-180-2-T4

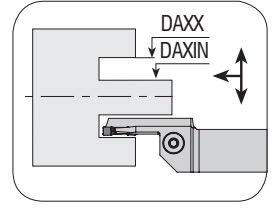
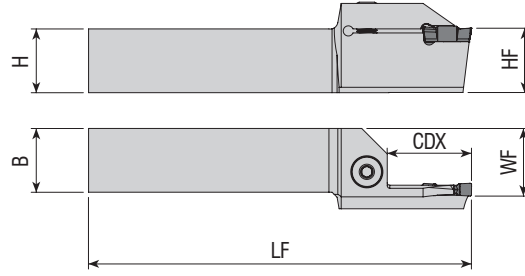

Takım Kodu
Ordering Code
Код для заказа

Stok Stock Наличие	Takım Ölçüleri (mm) Dimension (mm) Размеры (мм)									Kesici Uç Insert Пластина	Yedek Parçaları / Spare Parts / Запасные части		
	R	L	HF=H	B	LF	WF	CDX	DAXIN	DAXX		Sıkma Vidası Screw Зажимной винт	Pul Stamp Шайба	Anahtar Allen Key Ключ
AAKT-IG-R/L-2525-40-60-4-T25	●	●	25	25	150	26.5	25	40	60	DGN / GRP - 4	2004-M8x1x20	-	AAL-05-4
AAKT-IG-R/L-2525-52-80-4-T25	●	●	25	25	150	26.5	25	52	80				
AAKT-IG-R/L-2525-70-110-4-T28	●	●	25	25	150	26.5	28	70	110				
AAKT-IG-R/L-2525-72-110-4-T25	○	○	25	25	150	26.5	25	72	110				
AAKT-IG-R/L-2525-100-150-4-T25	●	○	25	25	150	26.5	25	100	150				
AAKT-IG-R/L-2525-110-200-4-T28	●	○	25	25	150	26.5	28	110	200				
AAKT-IG-R/L-2525-110-200-4-T32	●	●	25	25	150	26.5	32	110	200				
AAKT-IG-R/L-2525-140-200-4-T25	○	○	25	25	150	26.5	25	140	200				
AAKT-IG-R/L-2525-180-800-4-T28	●	●	25	25	150	26.5	28	180	800				
AAKT-IG-R/L-2525-200-800-4-T25	○	○	25	25	150	26.5	25	200	800				
AAKT-IG-R/L-2525-70-110-5-T32	●	●	25	25	150	26.5	32	70	110	DGN / GRP - 5			
AAKT-IG-R/L-2525-110-200-5-T9	●	○	25	25	150	26.5	9	110	200				
AAKT-IG-R/L-2525-110-200-5-T32	●	●	25	25	150	26.5	32	110	200				
AAKT-IG-R/L-2525-180-800-5-T32	●	●	25	25	150	26.5	32	180	800	DGN / GRP - 6			
AAKT-IG-R/L-2525-58-100-6-T32	●	○	25	25	150	26.5	32	58	100				
AAKT-IG-R/L-2525-88-180-6-T32	●	○	25	25	150	26.5	32	88	180				

R: Sağ / Right / Правый L: Sol / Left / Левый
● Stokta / In Stock / В наличии ○ Stokta Yok / Non Stock Item / Нет в наличии
ISCR Uçuna Uygunudur. / Compatiple with ISCR Insert. / Под пластину ISCR.

Sipariş Örneği/Ordering Example/Образец заказа
1 ad./pcs./шт. AAKT-IG-R-2525-40-60-4-T25



L TİP ALIN KANAL AÇMA TAKIMLARI

L TYPE FACE EXTERNAL GROOVING TOOLHOLDERS

ДЕРЖАВКИ L-ТИПА ДЛЯ ОБРАБОТКИ ТОРЦЕВЫХ КАНАВОК

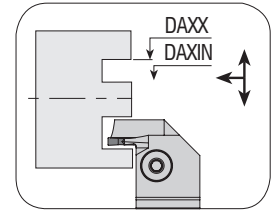
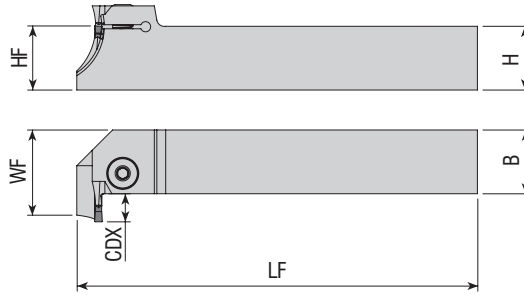

Takım Kodu Ordering Code Код для заказа	Stok Stock Наличие		Takım Ölçüleri (mm) Dimension (mm) Размеры (мм)							Kesici Uç Insert Пластина	Yedek Parçaları / Spare Parts / Запасные части		
	R	L	HF=H	B	LF	WF	CDX	DAXIN	DAXX		Sıkma Vidası Screw Зажимной винт	Pul Stamp Шайба	Anahtar Allen Key Ключ
ALKT-ZCC2-R/L-2525-35-45-3-T10	●	●	25	25	150	36	10	35	45	Z.FD - 3	2004-M8x1x20	-	AAL-05-4
ALKT-ZCC2-R/L-2525-39-55-3-T10	●	●	25	25	150	36	10	39	55				
ALKT-ZCC2-R/L-2525-35-∞-3-T4	●	●	25	25	150	30	4	35	∞				
ALKT-ZCC2-R/L-2525-40-60-4-T14	●	●	25	25	150	40	14	40	60	Z.GD - 4	2004-M8x1x20	-	AAL-05-4
ALKT-ZCC2-R/L-2525-52-80-4-T14	●	○	25	25	150	40	14	52	80				
ALKT-ZCC2-R/L-2525-72-110-4-T14	●	○	25	25	150	40	14	72	110				
ALKT-ZCC2-R/L-2525-100-230-4-T14	●	○	25	25	150	40	14	100	230				
ALKT-ZCC2-R/L-2525-40-∞-4-T4	●	●	25	25	150	30	4	40	∞				

ZCC Ucuna Uygundur. / Compatible with ZCC Insert. / Под пластину ZCC.

KESME VE DERİN KANAL AÇMA LAMALARI

BLADES FOR PARTING AND DEEP GROOVING

НОЖИ ДЛЯ ОТРЕЗКИ И ОБРАБОТКИ ГЛУБОКИХ КАНАВОК

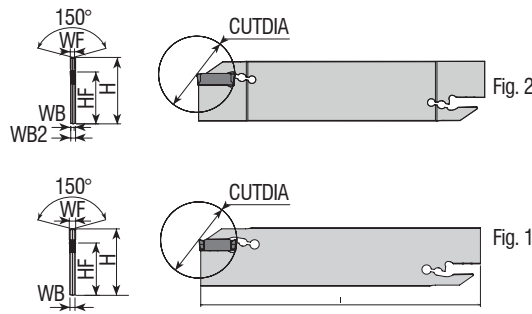
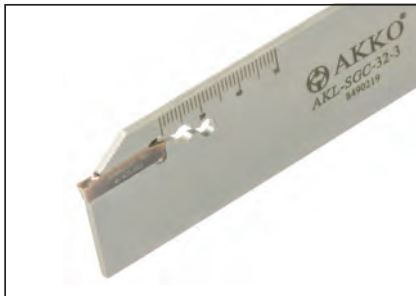

Takım Kodu Ordering Code Код для заказа	Stok Stock Наличие	Takım Ölçüleri (mm) Dimension (mm) Размеры (мм)								Kesici Uç Insert Пластина	Yedek Parçaları / Spare Parts / Запасные части
		H	WF	WB2	WB	I	HF	CUTDIA	Fig.		Anahtar Allen Key Ключ
AKL-SGC-26-3	●	26	3	2.40	-	110	21.4	39	2	GCM N30	ALA-02
AKL-SGC-32-3	●	32	3	2.40	-	150	25	39	1		

R: Sağ / Right / Правый L: Sol / Left / Левый

● Stokta / In Stock / В наличии ○ Stokta Yok / Non Stock Item / Нет в наличии

SMTM Ucuna Uygundur. / Compatible with SMTM Insert. / Под пластину SMTM.

Sipariş Örneği/Ordering Example/Образец заказа

1 ad./pcs./шт. ALKT-ZCC2-R-2525-35-45-3-T10



www.akko.com.tr

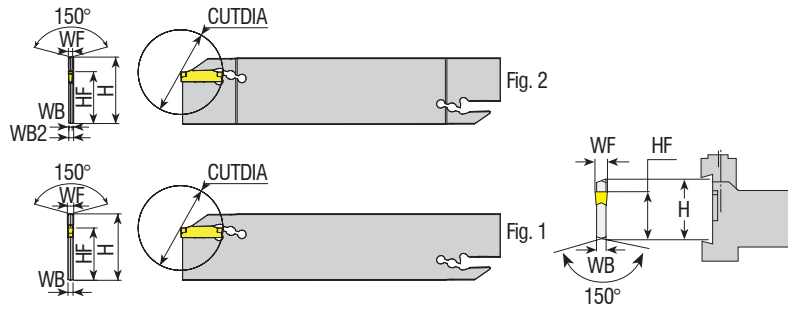

Takım Kodu Ordering Code Код для заказа	Stok Stock Наличие	Takım Ölçüleri (mm) Dimension (mm) Размеры (мм)								Kesici Uç Insert Пластина	Yedek Parçaları / Spare Parts Запасные части
		H	WF	WB2	WB	I	HF	CUTDIA	Fig.		
AKL-TD-32-2	●	32	2	2.4	1.6	150	25	39	2		
AKL-TD-32-3	●	32	3	2.4	-	150	25	39	1		

TGTC Ucuna Uygun. / Compatible with TGTC Insert. / Под пластину TGTC.

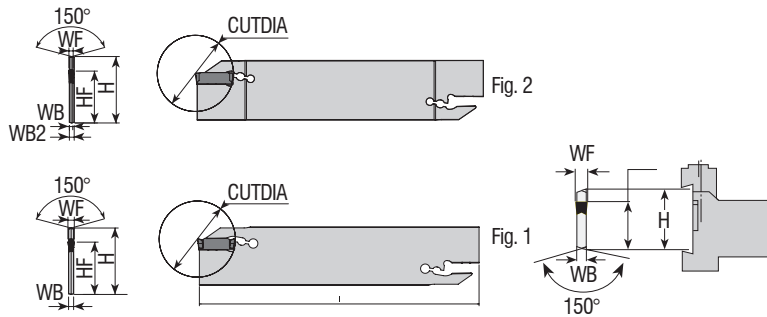

Takım Kodu Ordering Code Код для заказа	Stok Stock Наличие	Takım Ölçüleri (mm) Dimension (mm) Размеры (мм)								Kesici Uç Insert Пластина	Yedek Parçaları / Spare Parts Запасные части
		H	WF	WB2	WB	I	HF	CUTDIA	Fig.		
AKL-I-26-2	●	26	1.9-2.5	1.6	-	110	21.4	39	1		
AKL-I-32-2	●	32	1.9-2.5	1.8	2.4	150	25	39	2		
AKL-I-26-3	●	26	3-3.18	2.4	-	110	21.4	39	1	DGN - 3	
AKL-I-32-3	●	32	3-3.18	2.4	-	150	25	39	1		
AKL-I-26-4	●	26	4	3.2	-	110	21.4	80	1	DGN / GRP - 4	
AKL-I-32-4	●	32	4	3.2	-	150	25	100	1		

R: Sağ / Right / Правый L: Sol / Left / Левый

● Stokta / In Stock / В наличии ○ Stokta Yok / Non Stock Item / Нет в наличии

ISCR Ucuna Uygun. / Compatible with ISCR Insert. / Под пластину ISCR.

Sipariş Örneği/Ordering Example/Образец заказа

1 ad./pcs./шт. AKL-TD-32-2

KESME VE DERİN KANAL AÇMA LAMALARI
BLADES FOR PARTING AND DEEP GROOVING

НОЖИ ДЛЯ ОТРЕЗКИ И ОБРАБОТКИ ГЛУБОКИХ КАНАВОК

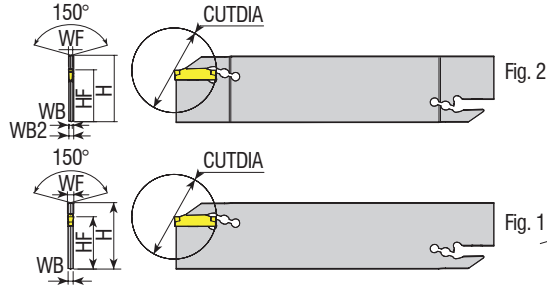

Takım Kodu Ordering Code Код для заказа	Stok Stock Наличие	Takım Ölçüleri (mm) Dimension (mm) Размеры (мм)								Kesici Uç Insert Пластина	Yedek Parçaları / Spare Parts Запасные части	
		H	WF	WB2	WB	I	HF	CUTDIA	Fig.		Anahtar Allen Key Ключ	
AKL-123-32-2	●	32	2	2.4	1.6	150	25	39	2		ALA-02	
AKL-123-32-3	●	32	3	2.4	-	150	25	39	1			
AKL-123-32-4	●	32	4	3.2	-	150	25	39	1			

SNDVK Ucuna Uygundur. / Compatible with SNDVK Insert. / Под пластину SNDVK.

KESME VE DERİN KANAL AÇMA LAMA BLOĞU
BLOCKS FOR PARTING AND DEEP GROOVING BLADES

БЛОКИ К СМЕННЫМ НОЖАМ ДЛЯ ОТРЕЗКИ И ОБРАБОТКИ ГЛУБОКИХ КАНАВОК

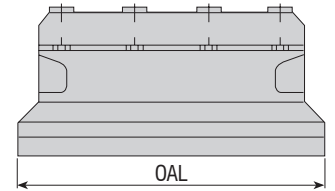
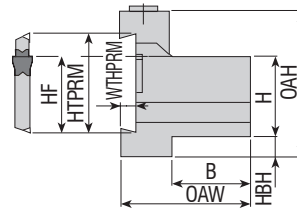

Takım Kodu Ordering Code Код для заказа	Stok Stock Наличие	Takım Ölçüleri (mm) Dimension (mm) Размеры (мм)									Yedek Parçaları / Spare Parts / Запасные части		
		HTPRM	HF	H	HBH	OAH	WTHPRM	OAL	B	OAW	Pabuç Clamp Spannspratze	Pabuç Vidası Clamp Screw Зажимной винт	Anahtar Allen Key Ключ
ALBU-20-26	●	26	21.4	20	9	43	4	86	19	38		2505-M6x25	AAL-07-5
ALBU-25-26	●	26	21.4	25	5	45	4	110	23	42			
ALBU-20-32	●	32	25	20	13	50	5.3	100	19	38			
ALBU-25-32	●	32	25	25	8	50	5.3	110	23	42			
ALBU-32-32	●	32	25	32	5	54	5.3	110	29	48			

R: Sağ / Right / Правый L: Sol / Left / Левый

● Stokta / In Stock / В наличии ○ Stokta Yok / Non Stock Item / Нет в наличии

Sipariş Örneği/Ordering Example/Образец заказа

1 ad./pcs./шт. AKL-123-32-2

*konusulan
the spoken kalite...
quality...*



*konusulan
the spoken kalite...
quality...*

KANAL AÇMA

İÇTEN SOĞUTMA KANALLI KANAL AÇMA TAKIMLARI
GROOVING TOOLHOLDERS WITH COOLANT HOLE
ДЕРЖАВКИ ДЛЯ ОБРАБОТКИ НАРУЖНЫХ КАНАВОК С ПОДВОДОМ СОЖ



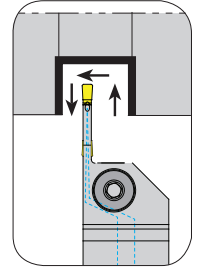
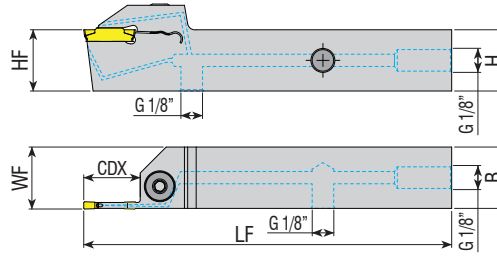

Takım Kodu
Ordering Code
Код для заказа

Takım Kodu Ordering Code Код для заказа	Stok Stock Наличие		Takım Ölçüleri (mm) Dimension (mm) Размеры (мм)					Kesici Uç Insert Пластина	Yedek Parçaları / Spare Parts / Запасные части		
	R	L	HF=H	B	LF	WF	CDX		Sıkma Vidası Screw Зажимной винт	Pul Stamp Шайба	Anahtar Allen Key Ключ
ADKT-K-R/L-2020-3-T20-H	●	●	20	20	125	20.4	20	MGM. - 3	2004-M8x1x20	-	AAL-05-4
ADKT-K-R/L-2525-3-T22-H	●	●	25	25	150	25.4	22				
ADKT-K-R/L-2020-4-T20-H	●	●	20	20	125	20.4	20	MGM. - 4			
ADKT-K-R/L-2525-4-T22-H	●	●	25	25	150	25.4	22				
ADKT-K-R/L-2525-5-T25-H	●	●	25	25	150	25.5	25	MGM. - 5			

KRLY Ucuna Uygun. / Compatible with KRLY Insert. / Под пластину KRLY.

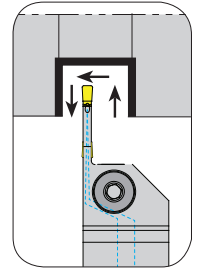
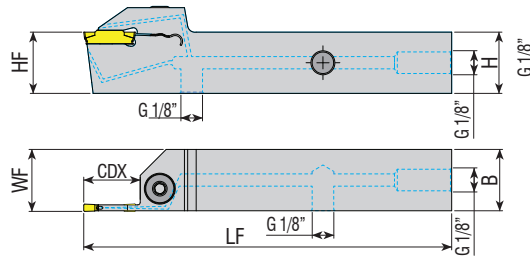

Takım Kodu
Ordering Code
Код для заказа

Takım Kodu Ordering Code Код для заказа	Stok Stock Наличие		Takım Ölçüleri (mm) Dimension (mm) Размеры (мм)					Kesici Uç Insert Пластина	Yedek Parçaları / Spare Parts / Запасные части		
	R	L	HF=H	B	LF	WF	CDX		Sıkma Vidası Screw Зажимной винт	Pul Stamp Шайба	Anahtar Allen Key Ключ
ADKT-TD-R/L-2020-3-T30-H	●	●	20	20	125	20.5	30	TD. - 3	2004-M8x1x20	-	AAL-05-4

R: Sağ / Right / Правый L: Sol / Left / Левый

● Stokta / In Stock / В наличии ○ Stokta Yok / Non Stock Item / Нет в наличии

TGTC Ucuna Uygun. / Compatible with TGTC Insert. / Под пластину TGTC.

Sipariş Örneği/Ordering Example/Образец заказа

1 ad./pcs./шт. ADKT-K-R-2020-3-T20-H

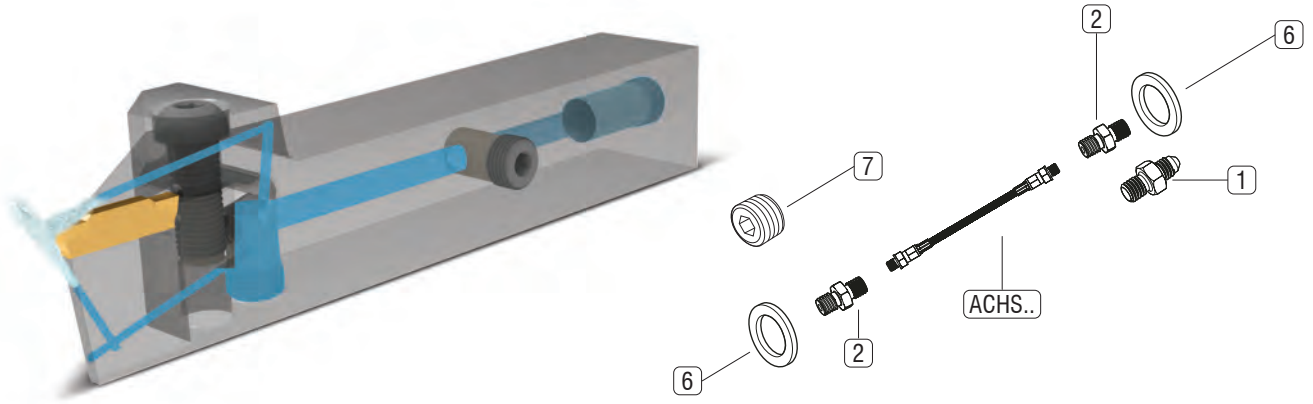

Not: İçten soğutmalı tüm torna katerlerinde kullanılabilecek 3 tip soğutma hortum setleri tasarlanmıştır. Takımların kullanılmasından önce, kullanılmayan bağlantıların set içindeki vida ile kapatılarak sızdırmazlığın sağlanmasına dikkat edilmelidir. Torna katerlerine yönelik soğutma hortum setleri, ACHS... 10 bar ile maksimum 275 bar basınç aralığında kullanılabilir.

Note: 3 types of cooling hose sets are designed that can be used in all internally cooled lathes. Before using the tools, care should be taken to ensure that the unused connections are closed with the screw in the set and that sealing is ensured. Cooling hose sets for lathe tools can be used in the pressure range of ACHS ... 10 bar to max 275 bar.

Примечание: Предлагается 3 типа комплектов трубок для подвода СОЖ. Они могут использоваться на всех токарных станках оснащенных системой подвода СОЖ. Перед началом работ необходимо закрыть неиспользуемые соединения винтом из набора и обеспечить герметичность системы подвода СОЖ. Комплекты охлаждающих трубок, для токарных инструментов, могут использоваться в диапазоне давлений АСНС от 10 бар до 275 бар.

Uzunluk / Length Code / Длина: 250

Set İçindeki Parçalar
Parts In The Set
Запчасти в Наборе

				Set Kodu: Set Code: Код Набора:	ACHS-1-250	Set Kodu: Set Code: Код Набора:	ACHS-2-250	Set Kodu: Set Code: Код Набора:	ACHS-3-250
	Resim Picture Рисунок	Takım Kodu Set Code Код Набора	Ürün Açıklaması Product Description Описание товара						
1		AMP-01	M10 Bağlantı Elemanı M10 Fastener Застежка M10	1x	-	-			
2		AMP-02	G 1/8" Çift Bağlantı Elemanı G 1/8" Double Fastener G 1/8" двойная застежка	2x	1x	-			
3		AMP-03	G 1/8" Açılı Bağlantısı G 1/8" Angle Connection G 1/8" угловое соединение	-	1x	2x			
4		AMP-04	M10" Açılı Bağlantısı M10" Angle Connection M10" угловое соединение	-	1x	1x			
5		AMP-05	G1/4"-G1/8" Kılcalma Parçası G1/4"-G1/8" Capillary Piece G1/4"-G1/8" Капиллярная часть	-	1x	1x			
6		AG-01	Bakır Conta Copper Gasket Медная прокладка	2x	3x	4x			
7		2705-G1/8-5.5	G1/8" Sızdırmaz Civata G1/8" Sealing Bolt G1/8" Уплотнительный болт	1x	1x	1x			
8		AH-1-250	Hortum Hose Трубка	1x	-	-			
9		AH-2-250	Hortum Hose Трубка	-	1x	-			
10		AH-3-250	Hortum Hose Трубка	-	-	1x			

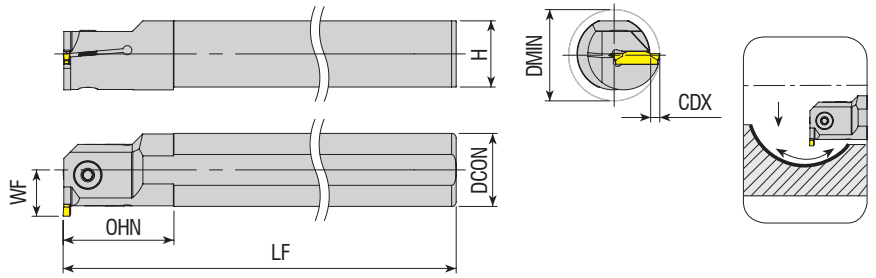

Takım Kodu
Ordering Code
Код для заказа

Stok
Stock
Наличие

Takım Ölçüleri (mm)
Dimension (mm)
Размеры (мм)

Kesici Uç
Insert
Пластина

Yedek Parçaları / Spare Parts / Запасные части

Sıkma Vidası
Screw
Зажимной винт

Anahtar
Allen Key
Ключ

Takım Kodu Ordering Code Код для заказа	Stok Stock Наличие		Takım Ölçüleri (mm) Dimension (mm) Размеры (мм)							Kesici Uç Insert Пластина	Sıkma Vidası Screw Зажимной винт	Anahtar Allen Key Ключ
	R	L	DCON	DMIN	LF	OHN	CDX	H	WF			
AIKT-K-R/L-16-2-T4	●	●	16	21	150	28	4	14.8	12	MGM. - 2	2503-M4x10	AAL-03-3
AIKT-K-R/L-20-2-T4	●	●	20	25	170	30	4	18.3	14		2503-M4x12	
AIKT-K-R/L-25-2-T6	●	●	25	32	200	40	6	23	18.5		2504-M5x12	
AIKT-K-R/L-20-3-T6	●	●	20	27	170	30	6	18.3	16	MGM. - 3	2504-M5x12	AAL-05-4
AIKT-K-R/L-20-3-T7	●	●	20	25	170	38	7	18.3	13		2504-M5x16	
AIKT-K-R/L-25-3-T6	●	●	25	32	200	40	6	23	18.5		2504-M5x16	
AIKT-K-R/L-25-3-T10	●	●	25	32	200	48	10	23	17		2004-M8x1x20	
AIKT-K-R/L-32-3-T6	●	●	32	39	250	50	6	30	22		2504-M5x12	
AIKT-K-R/L-32-3-T12	●	●	32	39	250	53	12	30	22		2504-M5x16	
AIKT-K-R/L-40-3-T6	●	●	40	47	300	55	6	37.5	26	MGM. - 4	2004-M8x1x20	AAL-05-4
AIKT-K-R/L-40-3-T12	●	○	40	48	300	63	12	37.5	27		2504-M5x12	
AIKT-K-R/L-20-4-T6	●	●	20	27	170	30	6	18.3	16		2504-M5x16	
AIKT-K-R/L-20-4-T7	●	○	20	25	170	38	7	18.3	13		2504-M5x16	
AIKT-K-R/L-25-4-T6	●	●	25	32	200	40	6	23	18.5		2004-M8x1x20	
AIKT-K-R/L-25-4-T10	●	●	25	32	200	49	10	23	17		2504-M5x12	
AIKT-K-R/L-32-4-T6	●	●	32	39	250	50	6	30	22	MGM. - 5	2504-M5x16	AAL-05-4
AIKT-K-R/L-32-4-T12	●	●	32	39	250	53	12	30	22		2004-M8x1x20	
AIKT-K-R/L-40-4-T6	●	●	40	47	300	55	6	37.5	26		2504-M5x16	
AIKT-K-R/L-40-4-T12	●	●	40	48	300	63	12	37.5	27	2004-M8x1x20		
AIKT-K-R/L-25-5-T7	●	●	25	33	200	40	7	23	19.5	MGM. - 5	2504-M5x16	AAL-05-4
AIKT-K-R/L-32-5-T7	●	●	32	40	250	50	7	30	23		2004-M8x1x20	
AIKT-K-R/L-40-5-T7	●	●	40	48	300	55	7	37.5	27		2504-M5x16	
AIKT-K-R/L-40-5-T12	●	○	40	48	300	63	12	37.5	27		2004-M8x1x20	

R: Sağ / Right / Правый L: Sol / Left / Левый

● Stokta / In Stock / В наличии ○ Stokta Yok / Non Stock Item / Нет в наличии

KRLY Ucuna Uygundur. / Compatiple with KRLY Insert. / Под пластину KRLY.

Sipariş Örneği/Ordering Example/Образец заказа

1 ad./pcs./шт. AIKT-K-R-16-2-T4

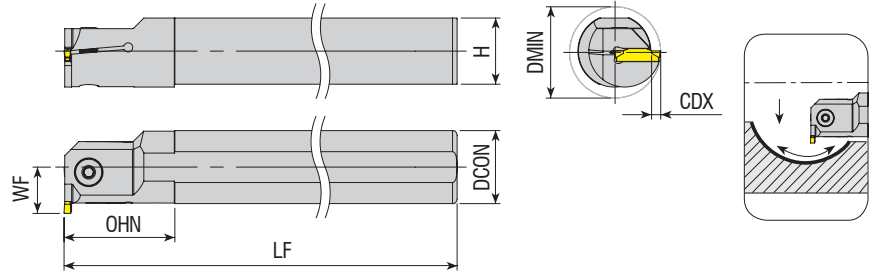

Takım Kodu Ordering Code Код для заказа	Stok Stock Наличие		Takım Ölçüleri (mm) Dimension (mm) Размеры (мм)							Kesici Uç Insert Пластина	Yedek Parçaları / Spare Parts / Запасные части	
	R	L	DCON	DMIN	LF	OHN	CDX	H	WF		Sıkma Vidası Screw Зажимной винт	Anahtar Allen Key Ключ
AİKT-KG-R/L-25-2-T7	●	●	25	33	200	40	7	23	19.5	KG.. - 2	2504-M5x12	AAL-05-4
AİKT-KG-R/L-20-3-T6.5-H	●	○	20	27.5	170	30	6.5	18.3	16.5		2504-M5x16	
AİKT-KG-R/L-25-3-T7	○	○	25	33	200	40	7	23	19.5	KG.. - 3	2004-M8x1x20	
AİKT-KG-R/L-40-3-T8	●	○	40	50	300	55	8	37.5	28		2504-M5x16	
AİKT-KG-R/L-25-4-T8	●	●	25	34	200	40	8	23	20.5	KG.. - 4	2504-M5x16	

KRLY Ucuna Uygundur. / Compatible with KRLY Insert. / Под пластину KRYL

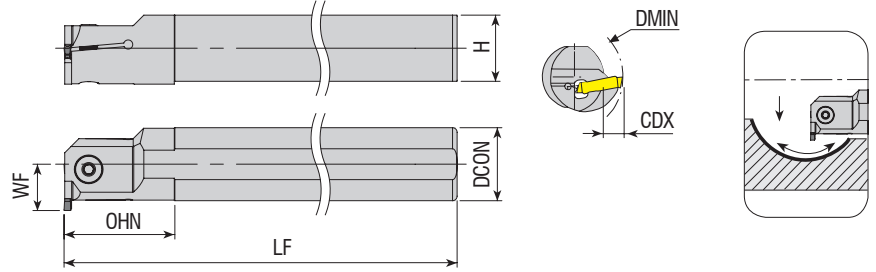

Takım Kodu Ordering Code Код для заказа	Stok Stock Наличие		Takım Ölçüleri (mm) Dimension (mm) Размеры (мм)							Kesici Uç Insert Пластина	Yedek Parçaları / Spare Parts / Запасные части	
	R	L	DCON	DMIN	LF	OHN	CDX	H	WF		Sıkma Vidası Screw Зажимной винт	Anahtar Allen Key Ключ
AİKT-H-R/L-25-3-T8	●	●	25	34	200	40	8	23	20.5	S229 - 3	2504-M5x16	AAL-05-4
AİKT-H-R/L-32-3-T7	●	●	32	40	250	50	7	30	23		2004-M8x1x20	
AİKT-H-R/L-40-3-T7	●	●	40	48	300	55	7	37.5	27	S229 - 4	2504-M5x16	
AİKT-H-R/L-25-4-T8	●	●	25	34	200	40	8	23	20.5		2004-M8x1x20	
AİKT-H-R/L-32-4-T7	●	●	32	40	250	50	7	30	23	S229 - 5	2504-M5x16	
AİKT-H-R/L-40-4-T7	●	●	40	48	300	55	7	37.5	27		2004-M8x1x20	
AİKT-H-R/L-25-5-T8	●	●	25	34	200	40	8	23	20.5			
AİKT-H-R/L-32-5-T7	●	○	32	40	250	50	7	30	23			
AİKT-H-R/L-40-5-T7	●	○	40	48	300	55	7	37.5	27			

R: Sağ / Right / Правый L: Sol / Left / Левый
 ● Stokta / In Stock / В наличии ○ Stokta Yok / Non Stock Item / Нет в наличии
 HRN Ucuna Uygundur. / Compatible with HRN Insert. / Под пластину HRN

Sipariş Örneği/Ordering Example/Образец заказа
 1 ad./pcs./шт. AİKT-KG-R-25-2-T7

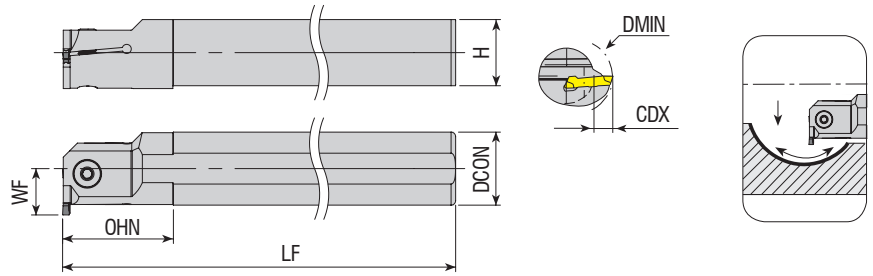

Takım Kodu Ordering Code Код для заказа	Stok Stock Наличие		Takım Ölçüleri (mm) Dimension (mm) Размеры (мм)							Kesici Uç Insert Пластина	Yedek Parçaları / Spare Parts / Запасные части	
	R	L	DCON	DMIN	LF	OHN	CDX	H	WF		Sıkma Vidası Screw Зажимной винт	Anahtar Allen Key Ключ
AIKT-HK-R/L-20-2-T6	●	●	20	26	170	30	6	18.3	16	S224 - 2	2503-M4x12	AAL-03-3
AIKT-HK-R/L-25-2-T6	●	○	25	32	200	40	6	23	18.5		2504-M5x16	
AIKT-HK-R/L-20-3-T6	●	○	20	27	170	30	6	18.3	16	S224 - 3	2504-M5x12	AAL-05-4
AIKT-HK-R/L-25-3-T6	●	●	25	32	200	40	6	23	18.5		2504-M5x16	
AIKT-HK-R/L-32-3-T6	●	●	32	39	250	50	6	30	22	S224 - 4	2004-M8x1x20	AAL-05-4
AIKT-HK-R/L-20-4-T6	●	○	20	27	170	30	6	18.3	16		2504-M5x12	
AIKT-HK-R/L-25-4-T6	●	○	25	32	200	40	6	23	18.5	2504-M5x16	AAL-05-4	
AIKT-HK-R/L-32-4-T6	●	○	32	39	250	50	6	30	22	2004-M8x1x20		
AIKT-HS223-R/L-20-2-T5	●	○	20	26	170	33	5	18.3	15	S223 - 2	2503-M4x12	AAL-03-3
AIKT-HS223-R/L-25-2-T5	●	○	25	31	200	40	5	23	17.5		2504-M5x16	
AIKT-HS223-R/L-20-3-T6	●	○	20	27	170	33	6	18.3	16	S223 - 3	2504-M5x12	AAL-05-4
AIKT-HS223-R/L-25-3-T6	●	○	25	32	200	40	6	23	18.5		2504-M5x16	

HRN Ucuna Uygun. / Compatible with HRN Insert. / Под пластину HRN

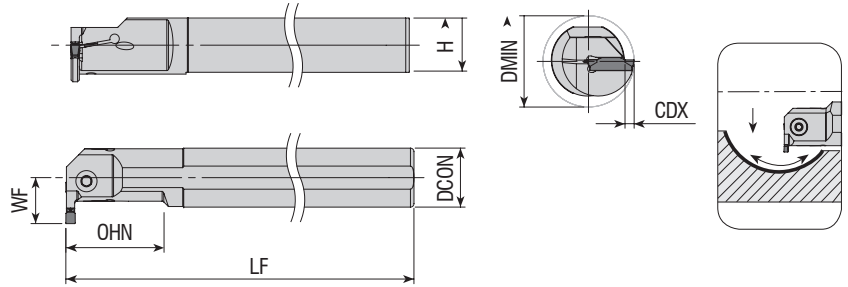

Takım Kodu Ordering Code Код для заказа	Stok Stock Наличие		Takım Ölçüleri (mm) Dimension (mm) Размеры (мм)							Kesici Uç Insert Пластина	Yedek Parçaları / Spare Parts / Запасные части	
	R	L	DCON	DMIN	LF	OHN	CDX	H	WF		Sıkma Vidası Screw Зажимной винт	Anahtar Allen Key Ключ
AIKT-KM-R/L-20-2-T7	●	●	20	25	170	40	7	18.3	13	A4 - 2	2503-M4x12	AAL-03-3
AIKT-KM-R/L-20-3-T7	●	○	20	25	170	40	7	18.3	13		2504-M5x12	AAL-05-4
AIKT-KM-R/L-25-3-T10	●	●	25	32	200	50	10	23	17	A4 - 3	2505-M6x16	AAL-07-5
AIKT-KM-R/L-32-3-T12	●	●	32	40	250	64	12	30	22		2505-M6x20	
AIKT-KM-R/L-40-3-T12	●	●	40	48	300	80	12	37.5	27	A4 - 4	2504-M5x12	AAL-05-4
AIKT-KM-R/L-20-4-T7	●	○	20	25	170	40	7	18.3	13		2504-M5x14	
AIKT-KM-R/L-32-4-T12.2-H	●	○	32	40	190	104	12.2	31	22			

R: Sağ / Right / Правый L: Sol / Left / Левый

● Stokta / In Stock / В наличии ○ Stokta Yok / Non Stock Item / Нет в наличии

KNMTL Ucuna Uygun. / Compatible with KNMTL Insert. / Под пластину KNMTL.

Sipariş Örneği/Ordering Example/Образец заказа

1 ad./pcs./шт. AIKT-HK-R-20-2-T6

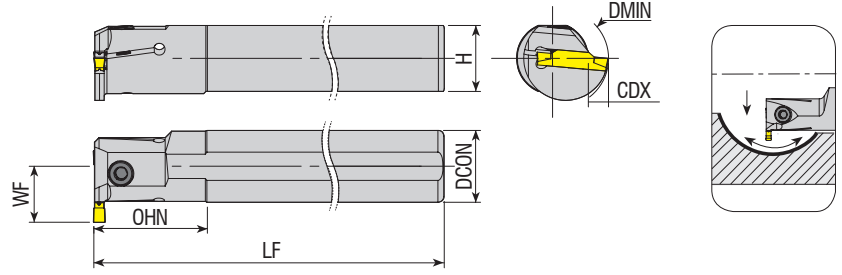

Takım Kodu Ordering Code Код для заказа	Stok Stock Наличие		Takım Ölçüleri (mm) Dimension (mm) Размеры (мм)							Kesici Uç Insert Пластина	Yedek Parçaları / Spare Parts / Запасные части		
	R	L	DCON	DMIN	LF	OHN	CDX	H	WF		Sıkma Vidası Screw Зажимной винт	Anahtar Allen Key Ключ	
AIKT-123-R/L-20-2-T6	●	○	20	32	170	30	6	18.3	16	123 - 2			AAL-03-3
AIKT-123-R/L-25-2-T6	●	○	25	32	200	40	6	18.3	18.5				
AIKT-123-R/L-32-2-T7	●	○	32	41	250	45	7	30	23				
AIKT-123-R/L-20-3-T6	●	○	20	32	170	30	6	18.3	16	123 - 3		AAL-05-4	
AIKT-123-R/L-25-3-T7	●	○	25	32	200	40	7	23	19.5				
AIKT-123-R/L-32-3-T9	●	○	32	41	250	50	9	30	25				
AIKT-123-R/L-20-4-T8	●	○	20	29	170	30	8	18.3	18	123 - 4		AAL-05-4	
AIKT-123-R/L-25-4-T7	●	○	25	32	200	40	7	23	19.5				
AIKT-123-R/L-32-4-T7	●	●	32	41	250	45	7	30	23				
AIKT-123-R/L-32-4-T10	●	○	32	43	250	50	10	30	26	123 - 5		AAL-05-4	
AIKT-123-R/L-25-5-T8	●	○	25	34	200	40	8	23	20.5				
AIKT-123-R/L-32-5-T11	●	●	32	43	250	50	11	30	27				

SNDVK Ucuna Uygundur. / Compatiple with SNDVK Insert. / Под пластину SNDVK.

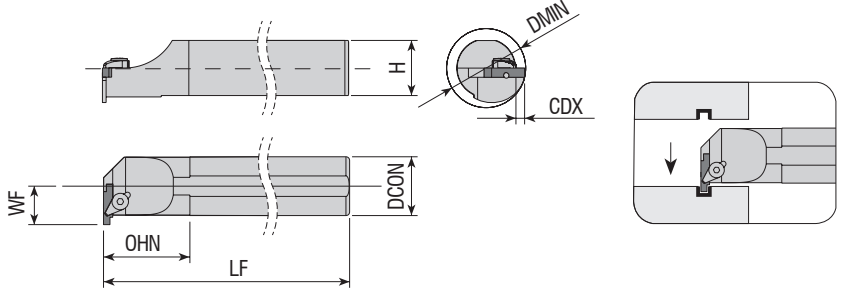

Takım Kodu Ordering Code Код для заказа	Stok Stock Наличие		Takım Ölçüleri (mm) Dimension (mm) Размеры (мм)							Kesici Uç Insert Пластина	Yedek Parçaları / Spare Parts / Запасные части				
	R	L	DCON	DMIN	LF	OHN	CDX	H	WF		Baskı Parçası Wedge Clamp Прижим	Sıkma Vidası Screw Зажимной винт	Pim Pin Stift	Anahtar Allen Key Ключ	
AIKT-154.91-R/L-16-3-T3	●	●	16	20	150	35	3	14.8	11	154.91 - 3				APM-06	AAL-05-4
AIKT-154.91-R/L-20-3-T4	●	●	20	25	170	38	4	18.3	14						
AIKT-154.91-R/L-25-3-T4	●	●	25	31	200	40	4	23	16.5						
AIKT-154.91-R/L-25-5-T5	●	●	25	31	200	45	5	23	17.5	154.91 - 5				APM-06	AAL-03-3
AIKT-154.91-R/L-32-5-T5	●	●	32	38	250	50	5	30	21						

R: Sağ / Right / Правый L: Sol / Left / Левый

● Stokta / In Stock / В наличии ○ Stokta Yok / Non Stock Item / Нет в наличии

SNDVK Ucuna Uygundur. / Compatiple with SNDVK Insert. / Под пластину SNDVK.

Sipariş Örneği/Ordering Example/Образец заказа

1 ad./pcs./шт. AIKT-123-R-20-2-T6

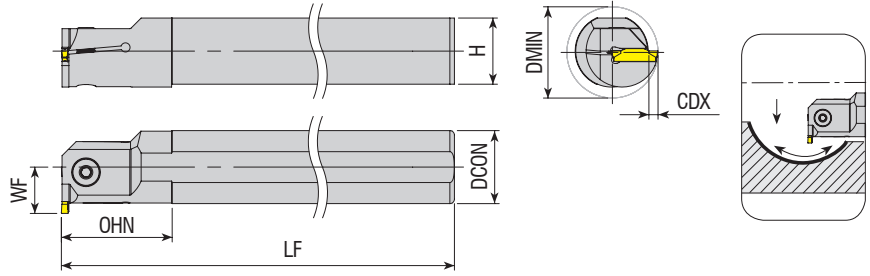

Takım Kodu
Ordering Code
Код для заказа

Takım Kodu Ordering Code Код для заказа	Stok Stock Наличие		Takım Ölçüleri (mm) Dimension (mm) Размеры (мм)							Kesici Uç Insert Пластина	Yedek Parçaları / Spare Parts / Запасные части	
	R	L	DCON	DMIN	LF	OHN	CDX	H	WF		Sıkma Vidası Screw Зажимной винт	Anahtar Allen Key Ключ
AIKT-RD-R/L-16-2-T6	●	○	16	24	150	28	6	14.8	14	RD. - 2	2503-M4x10	AAL-03-3
AIKT-RD-R/L-20-2-T6	●	○	20	28	170	28	6	18.3	16			
AIKT-RD-R/L-25-2-T6	●	○	25	33	200	28	6	23	18.5			
AIKT-RD-R/L-16-3-T6	●	○	16	24	150	28	6	14.8	14	RD. - 3	2503-M4x10	AAL-05-4
AIKT-RD-R/L-20-3-T6	●	○	20	28	170	28	6	18.3	16			
AIKT-RD-R/L-25-3-T6	●	○	25	33	200	28	6	23	18.5			
AIKT-RD-R/L-32-3-T6	●	○	32	40	250	50	6	30	22	RD. - 4	2004-M8x1x20	
AIKT-RD-R/L-20-4-T6	●	○	20	28	170	28	6	18.3	16			
AIKT-RD-R/L-25-4-T6	●	○	25	33	200	28	6	23	18.5	RD. - 4	2504-M5x16	
AIKT-RD-R/L-32-4-T6	●	○	32	40	250	50	6	30	22			

TGTC Uçuna Uygundur. / Compatible with TGTC Insert. / Под пластину TGTC.

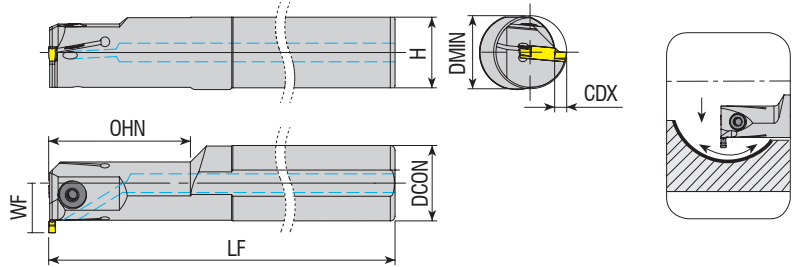

Takım Kodu
Ordering Code
Код для заказа

Takım Kodu Ordering Code Код для заказа	Stok Stock Наличие		Takım Ölçüleri (mm) Dimension (mm) Размеры (мм)							Kesici Uç Insert Пластина	Yedek Parçaları / Spare Parts / Запасные части	
	R	L	DCON	DMIN	LF	OHN	CDX	H	WF		Sıkma Vidası Screw Зажимной винт	Anahtar Allen Key Ключ
AIKT-TD-R/L-16-2-T8.5-H	●	○	16	25	150	28	8.5	14.8	16.5	TD. - 2	2503-M4x10	AAL-03-3
AIKT-TD-R/L-20-3-T6-H	●	○	20	25	170	40	6	18.3	16	TD. - 3	2504-M5x12	AAL-05-4
AIKT-TD-R/L-25-3-T6-H	●	○	25	25	200	40	6	23	18.5		2504-M5x16	
AIKT-TD-R/L-32-3-T5-H	●	○	32	31	250	60	5	30	21		2004-M8x1x20	

R: Sağ / Right / Правый L: Sol / Left / Левый

● Stokta / In Stock / В наличии ○ Stokta Yok / Non Stock Item / Нет в наличии

TGTC Uçuna Uygundur. / Compatible with TGTC Insert. / Под пластину TGTC.

Sipariş Örneği/Ordering Example/Образец заказа

1 ad./pcs./шт. AIKT-RD-R-16-2-T6

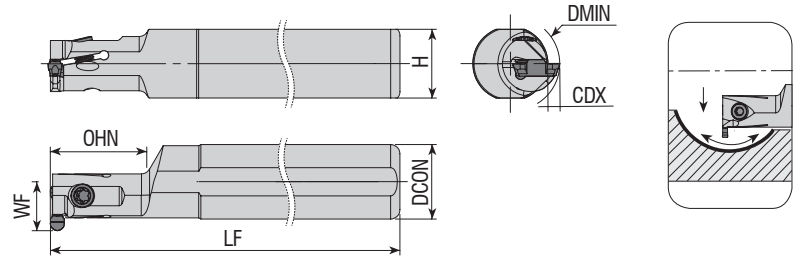

Takım Kodu Ordering Code Код для заказа	Stok Stock Наличие		Takım Ölçüleri (mm) Dimension (mm) Размеры (мм)							Kesici Uç Insert Пластина	Yedek Parçaları / Spare Parts / Запасные части	
	R	L	DCON	DMIN	LF	OHN	CDX	H	WF		Sıkma Vidası Screw Зажимной винт	Tork Anahtar Torx Key Торх Ключ
AIKT-IGE-R/L-10-2-T3-H	●	○	10	11.5	125	25	3	9	8.3	GEPI - 2	3008-M3x8	80-T08
AIKT-IGE-R/L-16-2-T3-D11.5	●	○	16	11.5	125	20	3	14.8	11.1		GEPI - 3	1315-M4x11
AIKT-IGE-R/L-16-2-T2.5-H	●	●	16	13	125	20	2.5	14.8	10.5			
AIKT-IGE-R/L-16-3-T2.5-H	●	○	16	13	125	20	2.5	14.8	10.5			
AIKT-IGE-R/L-16-3-T2.5-D20	●	○	16	20	125	28	2.5	14.8	10.5			

ISCR Ucuna Uygundur. / Compatible with ISCR Insert. / Под пластину ISCR.

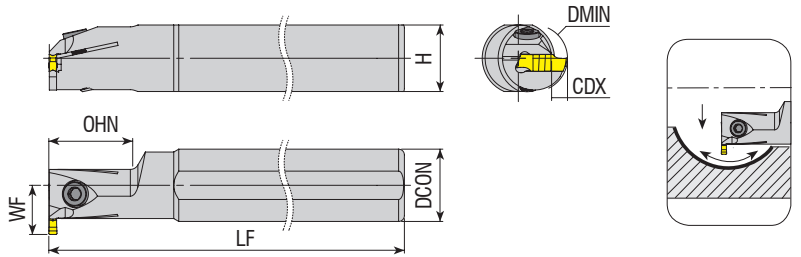

Takım Kodu Ordering Code Код для заказа	Stok Stock Наличие		Takım Ölçüleri (mm) Dimension (mm) Размеры (мм)							Kesici Uç Insert Пластина	Yedek Parçaları / Spare Parts / Запасные части		
	R	L	DCON	DMIN	LF	OHN	CDX	H	WF		Sıkma Vidası Screw Зажимной винт	Tork Anahtar Torx Key Торх Ключ	Anahtar Allen Key Ключ
AIKT-IGI-R/L-20-3-T4	●	●	20	20	170	25	4	18.3	14.5	GIMIY / GIPI - 3	1020-M5x14	80-T20	
AIKT-IGI-R/L-25-3-T5	●	●	25	23	200	30	5	23	17		2504-M5x16	AAL-05-4	
AIKT-IGI-R/L-32-3-T5	●	●	32	31	250	30	5	30	21		2004-M8x1x20		
AIKT-IGI-R/L-40-3-T5	●	○	40	50	300	50	5	37.5	25	GIMIY / GIPI - 4	1020-M5x14	80-T20	
AIKT-IGI-R/L-20-4-T4	●	●	20	20	170	25	4	18.3	14.5	GIMIY / GIPI - 5	2504-M5x16	AAL-05-4	
AIKT-IGI-R/L-25-5-T10	●	○	25	32	200	25	10	23	22.5				
AIKT-IGI-R/L-25-5-T15	●	○	25	37	200	25	15	23	27.5				

R: Sağ / Right / Правый L: Sol / Left / Левый
● Stokta / In Stock / В наличии ○ Stokta Yok / Non Stock Item / Нет в наличии
ISCR Ucuna Uygundur. / Compatible with ISCR Insert. / Под пластину ISCR.

Sipariş Örneği/Ordering Example/Образец заказа
1 ad./pcs./шт. AIKT-IGE-R-10-2-T3-H

Note: "OHN" boyları D min çapa göre verilmiştir.
Примечание: размеры "OHN" должны быть D min.

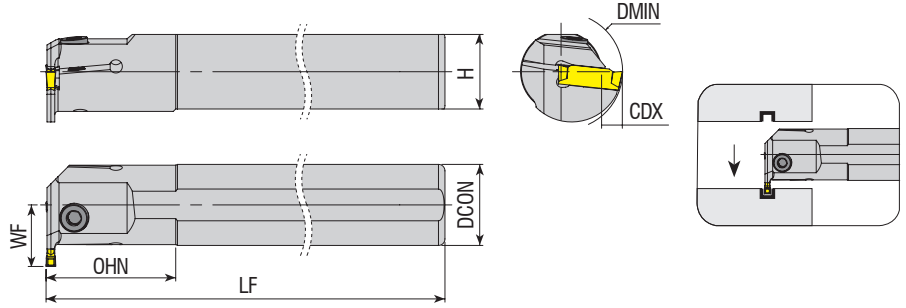

Takım Kodu Ordering Code Код для заказа	Stok Stock Наличие		Takım Ölçüleri (mm) Dimension (mm) Размеры (мм)							Kesici Uç Insert Пластина	Yedek Parçaları / Spare Parts / Запасные части	
	R	L	DCON	DMIN	LF	OHN	CDX	H	WF		Sıkma Vidası Screw Зажимной винт	Anahtar Allen Key Ключ
AIKT-I-R/L-20-3-T5	●	●	20	26	170	25	5	18.3	15.5	DGN - 3	2504-M5x12	AAL-05-4
AIKT-I-R/L-25-3-T6	●	●	25	32	200	40	6	23	19		2504-M5x16	

ISCR Ucuna Uygunur. / Compatiple with ISCR Insert. / Под пластину ISCR.

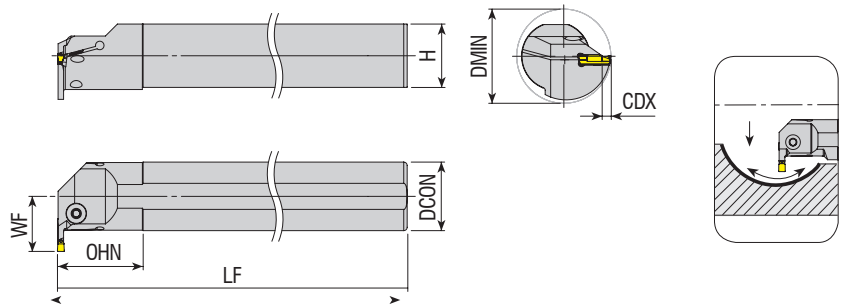

Takım Kodu Ordering Code Код для заказа	Stok Stock Наличие		Takım Ölçüleri (mm) Dimension (mm) Размеры (мм)							Kesici Uç Insert Пластина	Yedek Parçaları / Spare Parts / Запасные части	
	R	L	DCON	DMIN	LF	OHN	CDX	H	WF		Sıkma Vidası Screw Зажимной винт	Anahtar Allen Key Ключ
AIKT-IG-R/L-25-4-T10-H	●	●	25	36	200	40	10	23	22.7	DGN / GRP - 4	2504-M5X16	AAL-05-4
AIKT-IG-R/L-32-4-T10-H	●	●	32	43	250	45	10	30	26.2		2004-M8x1x20	
AIKT-IG-R/L-40-4-T12-H	●	●	40	53	250	50	12	37.5	32.2		2504-M5X16	
AIKT-IG-R/L-25-5-T10-H	●	○	25	36	200	40	10	23	22.7	DGN / GRP - 5	2004-M8x1x20	
AIKT-IG-R/L-32-5-T10-H	●	○	32	43	250	45	10	30	26.2		2504-M5X16	
AIKT-IG-R/L-40-5-T12-H	●	○	40	53	250	50	12	37.5	32.2		2004-M8x1x20	
AIKT-IG-R/L-50-5-T12-H	●	○	50	63	300	60	12	47	37.2		2004-M8x1x20	

R: Sağ / Right / Правый L: Sol / Left / Левый
● Stokta / In Stock / В наличии ○ Stokta Yok / Non Stock Item / Нет в наличии
ISCR Ucuna Uygunur. / Compatiple with ISCR Insert. / Под пластину ISCR.

Sipariş Örneği/Ordering Example/Образец заказа
1 ad./pcs./шт. AIKT-I-R-20-3-T5

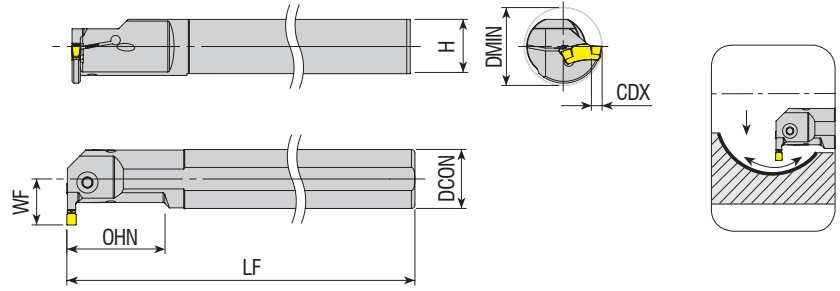

Takım Kodu Ordering Code Код для заказа	Stok Stock Наличие		Takım Ölçüleri (mm) Dimension (mm) Размеры (мм)							Kesici Uç Insert Пластина	Yedek Parçaları / Spare Parts / Запасные части		
	R	L	DCON	DMIN	LF	OHN	CDX	H	WF		Sıkma Vidası Screw Зажимной винт	Tork Anahtar Torx Key Торк Ключ	Anahtar Allen Key Ключ
AIKT-ITG-R/L-16-3-T6-H	●	●	16	20	150	25	6	14.8	12	TGM. - 3		1020-M4.5X14	80-T20
AIKT-ITG-R/L-20-3-T6-H	●	●	20	25	170	32	6	18.3	14.2			1020-M4.5X16	
AIKT-ITG-R/L-25-3-T8-H	●	●	25	32	200	40	8	23	18.8			2504-M5X16	AAL-05-4
AIKT-ITG-R/L-32-3-T8-H	●	●	32	38	250	49	8	30	22			2004-M8x1x20	
AIKT-ITG-R/L-20-4-T6-H	●	●	20	25	170	33	6	18.3	14.2	TGM. - 4		1020-M4.5X16	80-T20
AIKT-ITG-R/L-25-4-T7-H	●	●	25	31	200	41	7	23	17.5			2504-M5X16	AAL-05-4
AIKT-ITG-R/L-25-4-T9-H	●	●	25	32.5	200	41	9	23	19.5			2004-M8x1x20	
AIKT-ITG-R/L-32-4-T11-H	●	●	32	42	250	50	11	30	25.5				
AIKT-ITG-R/L-40-4-T11-H	●	●	40	53	300	50	11	37.5	32	TGM. - 6.35		2004-M8x1x20	
AIKT-ITG-R/L-32-6.35-T17.5-H	●	●	32	57	250	50	17.5	30	29				

ISCR Ucuna Uygunudur. / Compatible with ISCR Insert. / Под пластину ISCR.

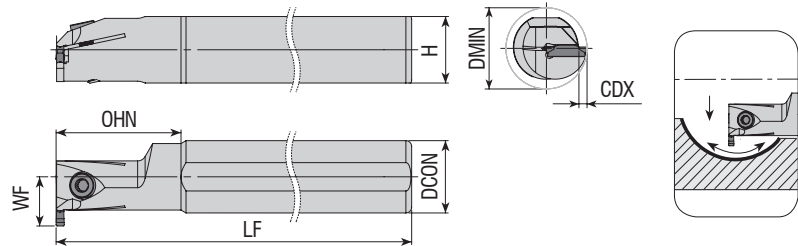

Takım Kodu Ordering Code Код для заказа	Stok Stock Наличие		Takım Ölçüleri (mm) Dimension (mm) Размеры (мм)							Kesici Uç Insert Пластина	Yedek Parçaları / Spare Parts / Запасные части		
	R	L	DCON	DMIN	LF	OHN	CDX	H	WF		Sıkma Vidası Screw Зажимной винт	Anahtar Allen Key Ключ	
AIKT-GP-R/L-20-2-T4	●	○	20	25	170	30	4	18.3	14.5	GP - 2		2503-M4x12	AAL-03-3
AIKT-GP-R/L-25-2-T6	●	○	25	32	200	40	6	23	18.5				
AIKT-GP-R/L-20-3-T6	●	○	20	27	170	30	6	18.3	16	GP - 3		2504-M5X16	AAL-05-4
AIKT-GP-R/L-25-3-T6	●	○	25	32	200	40	6	23	18.5				
AIKT-GP-R/L-32-3-T6	●	○	32	39	250	50	6	30	22	GP - 4		2004-M8x1x20	
AIKT-GP-R/L-20-4-T6	●	○	20	27	170	30	6	18.3	16				
AIKT-GP-R/L-25-4-T6	●	○	25	32	200	40	6	23	18.5				
AIKT-GP-R/L-32-4-T6	●	○	32	39	250	50	6	30	22				

R: Sağ / Right / Правый L: Sol / Left / Левый
● Stokta / In Stock / В наличии ○ Stokta Yok / Non Stock Item / Нет в наличии
PLBT Ucuna Uygunudur. / Compatible with PLBT Insert. / Под пластину PLBT.

Sipariş Örneği/Ordering Example/Образец заказа
1 ad./pcs./шт. AIKT-ITG-R-16-3-T6-H

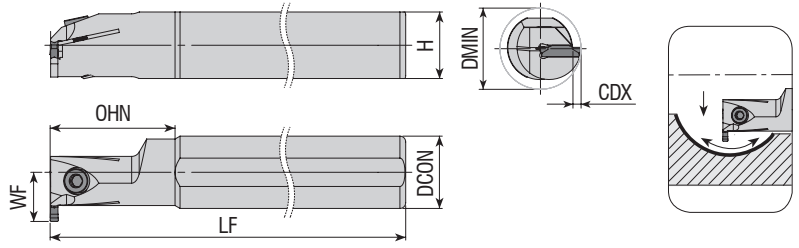

Takım Kodu Ordering Code Код для заказа	Stok Stock Наличие		Takım Ölçüleri (mm) Dimension (mm) Размеры (мм)							Kesici Uç Insert Пластина	Yedek Parçaları / Spare Parts / Запасные части		
	R	L	DCON	DMIN	LF	OHN	CDX	H	WF		Sıkma Vidası Screw Зажимной винт	Tork Anahtar Torx Key Торх Ключ	
AIKT-TG-R/L-20-2-T6	●	○	20	28	160	28	6	18.3	15.8	DGM2-020	2503-M4x10	AAL-03-3	
AIKT-TG-R/L-20-3-T6	●	○	20	28	160	28	6	18.3	15.8	DTX3-030	2504-M5x12	AAL-05-4	
AIKT-TG-R/L-25-3-T8	●	○	25	35	200	28	8	23	21.5		2504-M5x16		
AIKT-TG-R/L-32-3-T10	●	○	32	43	250	50	10	30	27	2004-M8x1x20			
AIKT-TG-R/L-32-3-T12	●	○	32	45	250	50	12	30	27				
AIKT-TG-R/L-32-4-T10	●	○	32	43	250	50	10	30	27		DTX4-040		
AIKT-TG-R/L-32-5-T10	●	○	32	43	250	50	10	30	27	DTX5-040			

TNGLY Ucuna Uygundur. / Compatible with TNGLY Insert. / Под пластины TNGLY.

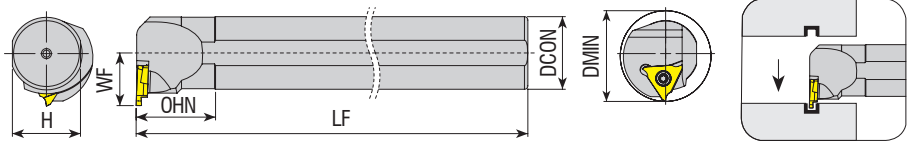

Takım Kodu Ordering Code Код для заказа	Stok Stock Наличие		Takım Ölçüleri (mm) Dimension (mm) Размеры (мм)							Kesici Uç Insert Пластина	Yedek Parçaları / Spare Parts / Запасные части	
	R	L	DCON	DMIN	LF	OHN	CDX	H	WF		Sıkma Vidası Screw Зажимной винт	Anahtar Allen Key Ключ
AIKT-QC11-R/L-20-(0.5-1.8)	●	○	20	16	150	40	-	18.3	12	QC11R/L (0.50-1.80)	3008 M2.5x6	80-T08
AIKT-QC16-R/L-20-(0.5-1.8)	○	○	20	25	150	35	-	18.3	13.5	QC16R/L (0.50-1.80)	4015-M3.5x10	80-T15
AIKT-QC16-R/L-20-(0.5-2.5)	●	○	20	25	150	35	-	18.3	13.5	QC16R/L (0.50-2.50)		
AIKT-QC22-R/L-25-(1-2.3)	○	○	25	35	150	35	-	23	18.2	QC22R/L (1.00-2.30)	1020 M5x11	80-T20
AIKT-QC22-R/L-25-(2.5-3.3)	●	○	25	35	150	35	-	23	18.2	QC22R/L (2.50-3.30)		
AIKT-QC22-R/L-25-(3.3-4.8)	●	○	25	35	150	35	-	23	18.2	QC22R/L (3.30-4.80)		
AIKT-QC22-R/L-32-(1-2.3)	○	○	32	45	150	35	-	30	23.2	QC22R/L (1.00-2.30)		

R: Sağ / Right / Правый L: Sol / Left / Левый

● Stokta / In Stock / В наличии ○ Stokta Yok / Non Stock Item / Нет в наличии

ZCC Ucuna Uygundur. / Compatible with ZCC Insert. / Под пластины ZCC.

Sipariş Örneği/Ordering Example/Образец заказа

1 ad./pcs./шт. AIKT-TG-R-20-2-T6

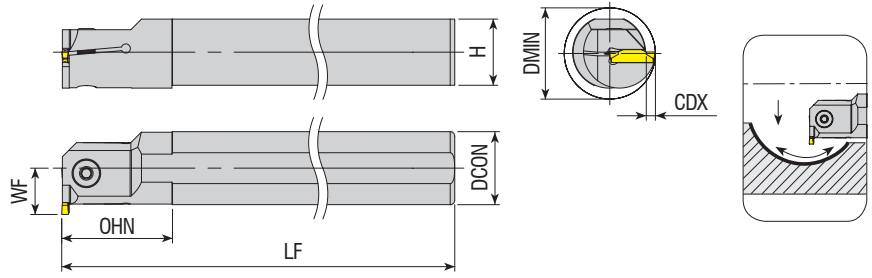

Takım Kodu Ordering Code Код для заказа	Stok Stock Наличие		Takım Ölçüleri (mm) Dimension (mm) Размеры (мм)							Kesici Uç Insert Пластина	Yedek Parçaları / Spare Parts / Запасные части	
	R	L	DCON	DMIN	LF	OHN	CDX	H	WF		Sıkma Vidası Screw Зажимной винт	Anahtar Allen Key Ключ
AIKT-ZCC2-R/L-16-2-T4	●	○	16	21	150	28	4	14.8	12	Z.BD - 2	2503-M4x10	AAL-03-3
AIKT-ZCC2-R/L-20-3-T5	●	●	20	27	170	30	5	18.3	15		Z.FD - 3	
AIKT-ZCC2-R/L-20-3-T8	●	○	20	29	170	30	8	18.3	18	2504-M5x16		
AIKT-ZCC2-R/L-25-3-T5	●	○	25	31	200	40	5	23	17.5	2004-M8x1x20		
AIKT-ZCC2-R/L-25-3-T10	●	○	25	36	200	40	10	23	22.5	2504-M5x12		AAL-05-4
AIKT-ZCC2-R/L-32-3-T6	●	○	32	39	250	50	6	30	22			
AIKT-ZCC2-R/L-32-3-T8	●	○	32	41	250	50	8	30	24	2504-M5x16		
AIKT-ZCC2-R/L-32-3-T13	●	○	32	46	250	50	13	30	29			
AIKT-ZCC2-R/L-40-3-T12	●	○	40	53	300	55	12	37.5	32			
AIKT-ZCC2-R/L-25-4-T6	●	○	25	32	200	40	6	23	18.5			2004-M8x1x20
AIKT-ZCC2-R/L-32-4-T7	●	○	32	40	250	50	7	30	23			
AIKT-ZCC2-R/L-32-4-T8	●	○	32	41	250	50	8	30	24			
AIKT-ZCC2-R/L-32-4-T10	●	○	32	43	250	50	10	30	26			
AIKT-ZCC2-R/L-32-5-T7	●	○	32	40	250	50	7	30	23	Z.HD - 5	2504-M5x16	
AIKT-ZCC2-R/L-32-5-T8	●	○	32	41	250	50	8	30	24			
AIKT-ZCC2-R/L-40-5-T8	●	○	40	49	300	55	8	37.5	28			
AIKT-ZCC2-R/L-40-5-T10	●	○	40	51	300	55	10	37.5	30			

ZCC Ucuna Uygundur. / Compatible with ZCC Insert. / Под пластину ZCC.

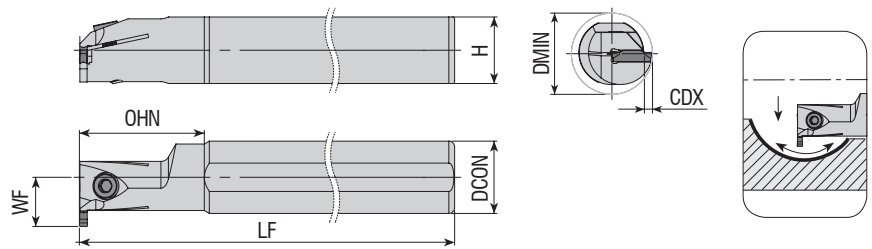

Takım Kodu Ordering Code Код для заказа	Stok Stock Наличие		Takım Ölçüleri (mm) Dimension (mm) Размеры (мм)							Kesici Uç Insert Пластина	Yedek Parçaları / Spare Parts / Запасные части	
	R	L	DCON	DMIN	LF	OHN	CDX	H	WF		Sıkma Vidası Screw Зажимной винт	Anahtar Allen Key Ключ
AIKT-SGC-R/L-25-3-T6	●	○	25	32	200	40	6	23	18.5	GCM N30	2504-M5x16	AAL-05-4
AIKT-SGC-R/L-32-3-T6	●	○	32	39	250	50	6	30	22		2004-M8x1x20	
AIKT-SGC-R/L-40-3-T6	●	○	40	47	300	55	6	37.5	26			

R: Sağ / Right / Правый L: Sol / Left / Левый
● Stokta / In Stock / В наличии ○ Stokta Yok / Non Stock Item / Нет в наличии
SMTM Ucuna Uygundur. / Compatible with SMTM Insert. / Под пластину SMTM

Sipariş Örneği/Ordering Example/Образец заказа
1 ad./pcs./шт. AIKT-ZCC2-R-16-2-T4

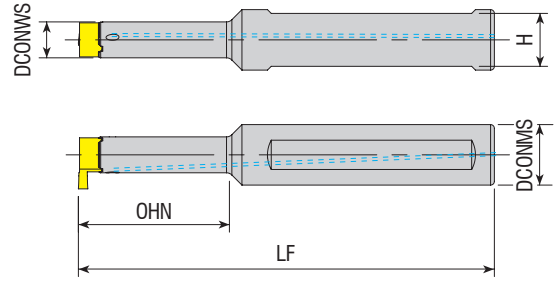

Takım Kodu Ordering Code Код для заказа	Stok Stock Наличие	Takım Ölçüleri (mm) Dimension (mm) Размеры (мм)					Kesici Uç Insert Пластина	Yedek Parçaları / Spare Parts / Запасные части		
		DCONMS	DCONWS	LF	OHN	H		Sıkma Vidası Screw Зажимной винт	Anahtar Allen Key Ключ	
AIKT-MB07-A16-090-15	●	16	7.4	90	15	14	MB - 07	4008-M3x8	80-T08	
AIKT-MB07-A16-090-22	●	16	7.4	90	22	14				
AIKT-MB09-A16-090-19	●	16	9.5	90	19	14	MB - 09	4015-M4x11	80-T15	
AIKT-MB09-A16-095-28	●	16	9.5	95	28	14				
AIKT-MB09-A16-110-40	●	16	9.5	110	40	14				

R: Sağ / Right / Правый L: Sol / Left / Левый

● Stokta / In Stock / В наличии ○ Stokta Yok / Non Stock Item / Нет в наличии

SNDVK Ucuna Uygundur. / Compatible with SNDVK Insert. / Под пластину SNDVK.

Sipariş Örneği/Ordering Example/Образец заказа

1 ad./pcs./шт. AIKT-MB07-A16-090-15



konusulan
the spoken **kalite...**
quality...





DELİK DELME ve İŞLEME TAKIMLARI
DRILLING and HOLEMAKING TOOLS
ИНСТРУМЕНТ ДЛЯ СВЕРЛЕНИЯ И ОБРАБОТКИ ОТВЕРСТИЙ





*konusulan
the spoken kalite...
quality...*

U-DRILL

TAKMA UÇLU MATKAPLAR
U-DRILL SYSTEM
СВЕРЛА





AKKO **A** **TUM** **16** x **D3**

S **P** **G** **T** **06** **02** **04**

2 Kesici Stili / Cutter Style
Тип режущего инструмента

TUM: Takma Uçlu Matkap
U-Drill
сверла

3 Takım Çapı / Tool Diameter /
Диаметр Сверла

4 Delme Derinliği / Drilling Depth /
Глубина сверления

5 Uç Şekli / Insert Form
Форма пластины

W **S**

6 Serbest Uç Açısı / Clearance angle of Insert
Задний угол пластины

C **P**

8 Uç Tipi / Insert Type
Форма пластины

A J T
 $\beta = 70-90^\circ$ $\beta = 70-90^\circ$ $\beta = 40-60^\circ$

B M U
 $\beta = 70-90^\circ$ $\beta = 40-60^\circ$ $\beta = 40-60^\circ$

C N W
 $\beta = 70-90^\circ$ $\beta = 40-60^\circ$ $\beta = 40-60^\circ$

F Q X **Özel**
 $\beta = 70-90^\circ$ $\beta = 40-60^\circ$ **Special**

G R **специальная**

H

10 Kalınlık / Thickness
Толщина

01 s = 1.59
T1 s = 1.98
02 s = 2.38
T2 s = 2.78
03 s = 3.18
T3 s = 3.97
04 s = 4.76
05 s = 5.56
06 s = 6.35
07 s = 7.94
09 s = 9.52

7 Toleranslar / Tolerance Classes / Допуск

	IC	M	S
A	± 0.025	± 0.005	± 0.025
C	± 0.025	± 0.013	± 0.025
E	± 0.025	± 0.025	± 0.025
F	± 0.013	± 0.005	± 0.025
G	± 0.025	± 0.025	± 0.130
H	± 0.013	± 0.013	± 0.025
J	± 0.05-0.15	± 0.005	± 0.025
K	± 0.05-0.15	± 0.013	± 0.025
L	± 0.05-0.15	± 0.025	± 0.025
M	± 0.05-0.15	± 0.08-0.20	± 0.130
N	± 0.05-0.15	± 0.08-0.20	± 0.025
U	± 0.08-0.25	± 0.13-0.38	± 0.130

IC : Daire Ölçüsü / Inscribed Circle / Вписанная окружность
M : Şekle Göre / Refer to Figure / Рисунок
S : Kalınlık / Thickness / Толщина

9 Kesme Kenar Uzunluğu / Cutting Edge Length
Длина режущей кромки

11 Köşe Konfigürasyonu / Corner Radius
Радиус при вершине

01 r = 0.1
02 r = 0.2
04 r = 0.4
08 r = 0.8
12 r = 1.2
16 r = 1.6
24 r = 2.4



Delme Derinliği = 2x Çap
Drilling Depth = 2x Diameter
Глубина сверления = 2x Диаметр

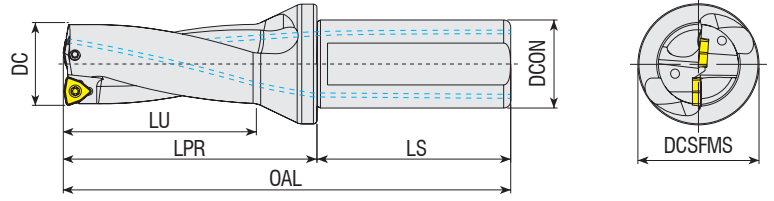

Takım Kodu
Ordering Code
Код для заказа

Stok
Stock
Наличие

Takım Ölçüleri (mm)
Dimension (mm)
Размеры (мм)

Maks. Ofset (radyal)
Max. Offset (radial)
Радиальное смещение

Kesici Uç
Insert
Пластина

Yedek Parçaları / Spare Parts / Запасные части

Sıkma Vidası
Screw
Зажимной винт

Tork Anahtar
Torx Key
Торк Ключ

DC

DCON

DCSFMS

OAL

LU

LPR

LS

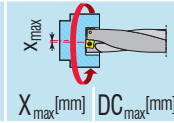

Takım Kodu Ordering Code Код для заказа	Stok Stock Наличие	DC	DCON	DCSFMS	OAL	LU	LPR	LS	Maks. Ofset (radyal) Max. Offset (radial) Радиальное смещение	Kesici Uç Insert Пластина	Sıkma Vidası Screw Зажимной винт	Tork Anahtar Torx Key Торк Ключ
ATUM 16XD2 WCM. 030208	●	16	25	34	110	32	54	56	1.5	19	WCM. 030208	3008-M2.5x6
ATUM 16.5XD2 WCM. 030208	●	16.5	25	34	110	32	54	56	1.5	19.5		
ATUM 17XD2 WCM. 030208	●	17	25	34	112	34	56	56	1.5	20		
ATUM 17.5XD2 WCM. 030208	●	17.5	25	34	112	34	56	56	1.5	20.5		
ATUM 18XD2 WCM. 030208	●	18	25	34	114	36	58	56	1.4	20.8		
ATUM 18.5XD2 WCM. 030208	●	18.5	25	34	114	36	58	56	1.3	21.1		
ATUM 19XD2 WCM. 030208	●	19	25	34	116	38	60	56	1.2	21.4		
ATUM 19.5XD2 WCM. 030208	●	19.5	25	34	116	38	60	56	1.2	21.9	WCM. 040208	80-T08
ATUM 20XD2 WCM. 040208	●	20	25	34	118	40	62	56	1.5	23		
ATUM 20.5XD2 WCM. 040208	●	20.5	25	34	118	40	62	56	1.5	23.5		
ATUM 21XD2 WCM. 040208	●	21	25	34	120	42	64	56	1	23		
ATUM 21.5XD2 WCM. 040208	●	21.5	25	34	120	42	64	56	1	23.5		
ATUM 22XD2 WCM. 040208	●	22	25	34	122	44	66	56	1	24		
ATUM 22.5XD2 WCM. 040208	●	22.5	25	34	122	44	66	56	1	24.5		
ATUM 23XD2 WCM. 040208	●	23	25	34	124	46	68	56	1	25	WCM. 050308	3008-M3x8
ATUM 23.5XD2 WCM. 040208	●	23.5	25	34	124	46	68	56	1	25.5		
ATUM 24XD2 WCM. 050308	●	24	25	34	126	48	70	56	1.4	26.8		
ATUM 24.5XD2 WCM. 050308	●	24.5	25	34	126	48	70	56	1.4	27.3		
ATUM 25XD2 WCM. 050308	●	25	25	34	128	50	72	56	1.45	27.9		
ATUM 25.5XD2 WCM. 050308	●	25.5	25	34	128	50	72	56	1.45	28.4		
ATUM 26XD2 WCM. 050308	●	26	25	34	130	52	74	56	1.45	28.9		
ATUM 26.5XD2 WCM. 050308	●	26.5	25	34	130	52	74	56	1.45	29.4		
ATUM 27XD2 WCM. 050308	●	27	25	34	132	54	76	56	1.45	29.9		
ATUM 27.5XD2 WCM. 050308	●	27.5	25	34	132	54	76	56	1.45	30.4		
ATUM 28XD2 WCM. 050308	●	28	25	34	134	56	78	56	1.6	31.2		
ATUM 28.5XD2 WCM. 050308	●	28.5	25	34	134	56	78	56	1.6	31.7		
ATUM 29XD2 WCM. 050308	●	29	25	34	136	58	80	56	1.65	32.3		
ATUM 29.5XD2 WCM. 050308	●	29.5	25	34	136	58	80	56	1.65	32.8		

R: Sağ / Right / Правый L: Sol / Left / Левый

● Stokta / In Stock / В наличии ○ Stokta Yok / Non Stock Item / Нет в наличии
ISO Uçuna Uygundur. / Compatible with ISO Insert. / Под пластину ISO.

Sipariş Örneği/Ordering Example/Образец заказа
1 ad./pcs./шт. ATUM 16XD2 WCM. 030208

Takma Uçlu Matkap Kullanım Kılavuzu : S 367 / User's Guide For U-Drills : P 367
Руководство для эксплуатации сверел: стр. 368



Delme Derinliği = 2x Çap
Drilling Depth = 2x Diameter
Глубина сверления = 2x Диаметр

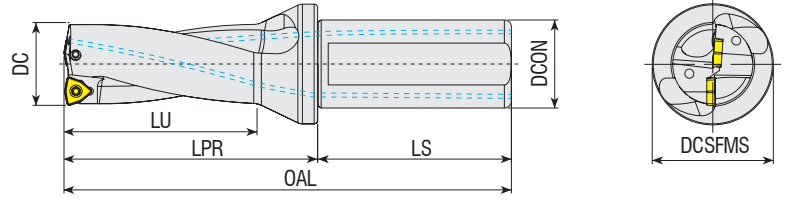

Takım Kodu
Ordering Code
Код для заказа

Stok Stock Наличие	Takım Ölçüleri (mm) Dimension (mm) Размеры (мм)								Maks. Ofset (radyal) Max. Offset (radial) Радиальное смещение		Kesici Uç Insert Пластина	Yedek Parçaları / Spare Parts / Запасные части	
	DC	DCON	DCSFMS	OAL	LU	LPR	LS	X _{max}	DC _{max} [mm]	Sıkma Vidası Screw Зажимной винт		Tork Anahtar Torx Key Торк Ключ	
●	30	32	44	147	60	87	60	2.4	34.8	WCM. 06T308	3010-M3.5x9	80-T10	
●	31	32	44	149	62	89	60	2.3	35.6				
●	32	32	44	151	64	91	60	2.1	36.2				
●	33	32	44	153	66	93	60	1.9	36.8				
●	34	32	44	155	68	95	60	1.9	37.8				
●	35	32	44	157	70	97	60	1.9	38.8				
●	36	32	44	159	72	99	60	2	40				
●	37	32	44	161	74	101	60	1.8	40.6				
●	38	32	44	163	76	103	60	1.5	41				
●	39	32	44	165	78	105	60	1.3	41.6				
●	40	32	44	167	80	107	60	1	42				
●	41	32	44	169	82	109	60	0.8	42.6				
●	42	32	44	171	84	111	60	0.5	43				
●	43	32	44	173	86	113	60	0.3	43.6				
●	44	32	44	175	88	115	60	0	44				
●	45	40	54	192	90	122	70	3.3	51.6	WCM. 080412	4015-M4x11	80-T15	
●	46	40	54	194	92	124	70	3	52				
●	47	40	54	196	94	126	70	2.8	52.6				
●	48	40	54	198	96	128	70	2.5	53				
●	49	40	54	200	98	130	70	2.2	53.4				
●	50	40	54	202	100	132	70	2	54				
●	51	40	54	204	102	134	70	1.8	54.6				
●	52	40	54	206	104	136	70	1.5	55				
●	53	40	54	208	106	138	70	1.3	55.6				
●	54	40	54	210	108	140	70	1	56				
●	55	40	54	212	110	142	70	0.8	56.6				
●	56	40	64	214	112	144	70	0.5	57				
●	57	40	64	216	114	146	70	0.3	57.6				
●	58	40	64	218	116	148	70	0	58				
●	59	40	64	220	118	150	70	0	59				
●	60	40	64	222	120	152	70	0	60				

R: Sağ / Right / Правый L: Sol / Left / Левый

● Stokta / In Stock / В наличии ○ Stokta Yok / Non Stock Item / Нет в наличии
ISO Ucuna Uygunudur. / Compatible with ISO Insert. / Под пластину ISO.

Sipariş Örneği/Ordering Example/Образец заказа

1 ad./pcs./шт. ATUM 30XD2 WCM. 06T308

Takma Uçlu Matkap Kullanım Kılavuzu : S 367 / User's Guide For U-Drills : P 367 / Руководство для эксплуатации сверел : стр. 368



Delme Derinliği = 3x Çap
Drilling Depth = 3x Diameter
Глубина сверления = 3x Диаметр

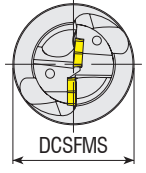
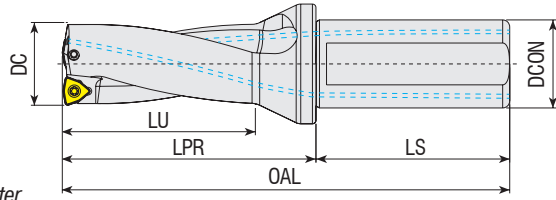

Takım Kodu
Ordering Code
Код для заказа

Stok Stock Наличие	Takım Ölçüleri (mm) Dimension (mm) Размеры (мм)							Maks. Ofset (radyal) Max. Offset (radial) Радиальное смещение		Kesici Uç Insert Пластина	Yedek Parçaları / Spare Parts / Запасные части	
	DC	DCON	DCSFMS	OAL	LU	LPR	LS	X _{max} X _{max} [mm]	DC _{max} DC _{max} [mm]		Sıkma Vidası Screw Зажимной винт	Tork Anahtar Torx Key Торх Ключ
●	16	25	34	126	48	70	56	1.5	19	WCM. 030208	3008-M2.5x6	80-T08
●	16.5	25	34	126	48	70	56	1.5	19.5			
●	17	25	34	129	51	73	56	1.5	20			
●	17.5	25	34	129	51	73	56	1.5	20.5			
●	18	25	34	132	54	76	56	1.4	20.8			
●	18.5	25	34	132	54	76	56	1.3	21.1			
●	19	25	34	135	57	79	56	1.2	21.4			
●	19.5	25	34	135	57	79	56	1.2	21.9			
●	20	25	34	138	60	82	56	1.5	23			
●	20.5	25	34	138	60	82	56	1.5	23.5	WCM. 040208	3008-M2.5x6	80-T08
●	21	25	34	141	63	85	56	1	23			
●	21.5	25	34	141	63	85	56	1	23.5			
●	22	25	34	144	66	88	56	1	24			
●	22.5	25	34	144	66	88	56	1	24.5			
●	23	25	34	147	69	91	56	1	25			
●	23.5	25	34	147	69	91	56	1	25.5			
●	24	25	34	150	72	94	56	1.4	26.8			
●	24.5	25	34	150	72	94	56	1.4	27.3			
●	25	25	34	153	75	97	56	1.45	27.9	WCM. 050308	3008-M3x8	80-T08
●	25.5	25	34	153	75	97	56	1.45	28.4			
●	26	25	34	156	78	100	56	1.45	28.9			
●	26.5	25	34	156	78	100	56	1.45	29.4			
●	27	25	34	159	81	103	56	1.45	29.9			
●	27.5	25	34	159	81	103	56	1.45	30.4			
●	28	25	34	162	84	106	56	1.6	31.2			
●	28.5	25	34	162	84	106	56	1.6	31.7			
●	29	25	34	165	87	109	56	1.65	32.3			
●	29.5	25	34	165	87	109	56	1.65	32.8	WCM. 06T308	3010-M3.5x9	80-T10
●	30	32	44	177	90	117	60	2.4	34.8			
●	30.5	32	44	177	90	117	60	2.4	35.3			
●	31	32	44	180	93	120	60	2.3	35.6			
●	31.5	32	44	180	93	120	60	2.3	36.1			
●	32	32	44	183	96	123	60	2.1	36.2			
●	32.5	32	44	183	96	123	60	2.1	36.7			
●	33	32	44	186	99	126	60	1.9	36.8			
●	33.5	32	44	186	99	126	60	1.9	37.3			
●	34	32	44	189	102	129	60	1.9	37.8			
●	34.5	32	44	189	102	129	60	1.9	38.3			

R: Sağ / Right / Правый L: Sol / Left / Левый

● Stokta / In Stock / В наличии ○ Stokta Yok / Non Stock Item / Нет в наличии

ISO Ucuna Uygundur. / Compatiple with ISO Insert. / Под пластину ISO.

Sipariş Örneği/Ordering Example/Образец заказа

1 ad./pcs./шт. ATUM 16XD3 WCM. 030208

Takma Uçlu Matkap Kullanım Kılavuzu : S 367 / User's Guide For U-Drills : P 367 / Руководство для эксплуатации сверел: стр. 368



Delme Derinliği = 3x Çap
Drilling Depth = 3x Diameter
Глубина сверления = 3x Диаметр

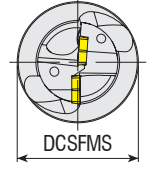
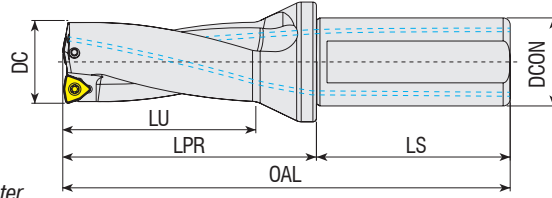

Takım Kodu
Ordering Code
Код для заказа

Stok Stock Наличие	Takım Ölçüleri (mm) Dimension (mm) Размеры (мм)							Maks. Ofset (radyal) Max. Offset (radial) Радиальное смещение		Kesici Uç Insert Пластина	Yedek Parçaları / Spare Parts / Запасные части		
	DC	DCON	DCSFMS	OAL	LU	LPR	LS	X _{max}	DC _{max} [mm]		Sıkma Vidası Screw Зажимной винт	Tork Anahtar Torx Key Торх Ключ	
ATUM 35XD3 WCM. 06T308	●	35	32	44	192	105	132	60	1.9	38.8	WCM. 06T308	3010-M3.5x9	80-T10
ATUM 35.5XD3 WCM. 06T308	●	35.5	32	44	192	105	132	60	1.9	39.3			
ATUM 36XD3 WCM. 06T308	●	36	32	44	195	108	135	60	2	40			
ATUM 36.5XD3 WCM. 06T308	●	36.5	32	44	195	108	135	60	2	40.5			
ATUM 37XD3 WCM. 06T308	●	37	32	44	198	111	138	60	1.8	40.6			
ATUM 37.5XD3 WCM. 06T308	●	37.5	32	44	198	111	138	60	1.8	41.1			
ATUM 38XD3 WCM. 06T308	●	38	32	44	201	114	141	60	1.5	41			
ATUM 38.5XD3 WCM. 06T308	●	38.5	32	44	201	114	141	60	1.5	41.5			
ATUM 39XD3 WCM. 06T308	●	39	32	44	204	117	144	60	1.3	41.6			
ATUM 39.5XD3 WCM. 06T308	●	39.5	32	44	204	117	144	60	1.3	42.1			
ATUM 40XD3 WCM. 06T308	●	40	32	44	207	120	147	60	1	42			
ATUM 40.5XD3 WCM. 06T308	●	40.5	32	44	207	120	147	60	1	42.5			
ATUM 41XD3 WCM. 06T308	●	41	32	44	210	123	150	60	0.8	42.6			
ATUM 41.5XD3 WCM. 06T308	●	41.5	32	44	210	123	150	60	0.8	43.1			
ATUM 42XD3 WCM. 06T308	●	42	32	44	213	126	153	60	0.5	43			
ATUM 42.5XD3 WCM. 06T308	●	42.5	32	44	213	126	153	60	0.5	43.5			
ATUM 43XD3 WCM. 06T308	●	43	32	44	216	129	156	60	0.3	43.6			
ATUM 43.5XD3 WCM. 06T308	●	43.5	32	44	216	129	156	60	0.3	44.1			
ATUM 44XD3 WCM. 06T308	●	44	32	44	219	132	159	60	0	44			
ATUM 44.5XD3 WCM. 06T308	●	44.5	32	44	219	132	159	60	0	44.5			
ATUM 45XD3 WCM. 080412	●	45	40	54	237	135	167	70	3.3	51.6	WCM. 080412	4015-M4x11	80-T15
ATUM 45.5XD3 WCM. 080412	●	45.5	40	54	237	135	167	70	3.3	52.1			
ATUM 46XD3 WCM. 080412	●	46	40	54	240	138	170	70	3	52			
ATUM 47XD3 WCM. 080412	●	47	40	54	243	141	173	70	2.8	52.6			
ATUM 48XD3 WCM. 080412	●	48	40	54	246	144	176	70	2.5	53			
ATUM 49XD3 WCM. 080412	●	49	40	54	249	147	179	70	2.2	53.4			
ATUM 50XD3 WCM. 080412	●	50	40	54	252	150	182	70	2	54			
ATUM 51XD3 WCM. 080412	●	51	40	54	255	153	185	70	1.8	54.6			
ATUM 52XD3 WCM. 080412	●	52	40	54	258	156	188	70	1.5	55			
ATUM 53XD3 WCM. 080412	●	53	40	54	261	159	191	70	1.3	55.6			
ATUM 54XD3 WCM. 080412	●	54	40	54	264	162	194	70	1	56			
ATUM 55XD3 WCM. 080412	●	55	40	54	267	165	197	70	0.8	56.6			
ATUM 56XD3 WCM. 080412	●	56	40	64	270	168	200	70	0.5	57			
ATUM 57XD3 WCM. 080412	●	57	40	64	273	171	203	70	0.3	57.6			
ATUM 58XD3 WCM. 080412	●	58	40	64	276	174	206	70	0	58			
ATUM 59XD3 WCM. 080412	●	59	40	64	279	177	209	70	0	59			
ATUM 60XD3 WCM. 080412	●	60	40	64	282	180	212	70	0	60			

R: Sağ / Right / Правый L: Sol / Left / Левый
● Stokta / In Stock / В наличии ○ Stokta Yok / Non Stock Item / Нет в наличии
ISO Ucuna Uygunudur. / Compatiple with ISO Insert. / Под пластину ISO.

Sipariş Örneği/Ordering Example/Образец заказа
1 ad./pcs./шт. ATUM 35XD3 WCM. 06T308
Takma Uçlu Matkap Kullanım Kılavuzu : S 367 / User's Guide For U-Drills : P 367
Руководство для эксплуатации сверел: стр. 368



Delme Derinliği = 4x Çap
Drilling Depth = 4x Diameter
Глубина сверления = 4x Диаметр

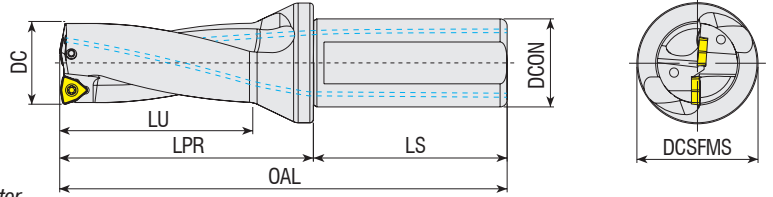

Takım Kodu Ordering Code Код для заказа	Stok Stock Наличие	Takım Ölçüleri (mm) Dimension (mm) Размеры (мм)							Maks. Ofset (radyal) Max. Offset (radial) Радиальное смещение		Kesici Uç Insert Пластина	Yedek Parçaları / Spare Parts / Запасные части	
		DC	DCON	DCSFMS	OAL	LU	LPR	LS	X _{max}	DC _{max}		Sıkma Vidası Screw Зажимной винт	Tork Anahtar Torx Key Торх Ключ
ATUM 16XD4 WCM. 030208	●	16	25	34	142	64	86	56	1.5	19	WCM. 030208		
ATUM 16.5XD4 WCM. 030208	○	16.5	25	34	142	64	86	56	1.5	19.5			
ATUM 17XD4 WCM. 030208	●	17	25	34	146	68	90	56	1.5	20			
ATUM 17.5XD4 WCM. 030208	●	17.5	25	34	146	68	90	56	1.5	20.5			
ATUM 18XD4 WCM. 030208	●	18	25	34	150	72	94	56	1.4	20.8			
ATUM 18.5XD4 WCM. 030208	○	18.5	25	34	150	72	94	56	1.3	21.1			
ATUM 19XD4 WCM. 030208	●	19	25	34	154	76	98	56	1.2	21.4			
ATUM 19.5XD4 WCM. 030208	○	19.5	25	34	154	76	98	56	1.2	21.9			
ATUM 20XD4 WCM. 040208	●	20	25	34	158	80	102	56	1.5	23	WCM. 040208	3008-M2.5x6	80-T08
ATUM 20.5XD4 WCM. 040208	○	20.5	25	34	158	80	102	56	1.5	23.5			
ATUM 21XD4 WCM. 040208	●	21	25	34	162	84	106	56	1	23			
ATUM 21.5XD4 WCM. 040208	○	21.5	25	34	162	84	106	56	1	23.5			
ATUM 22XD4 WCM. 040208	●	22	25	34	166	88	110	56	1	24			
ATUM 22.5XD4 WCM. 040208	●	22.5	25	34	166	88	110	56	1	24.5			
ATUM 23XD4 WCM. 040208	●	23	25	34	170	92	114	56	1	25			
ATUM 23.5XD4 WCM. 040208	○	23.5	25	34	170	92	114	56	1	25.5			
ATUM 24XD4 WCM. 050308	●	24	25	34	174	96	118	56	1.4	26.8	WCM. 050308	3008-M3x8	
ATUM 24.5XD4 WCM. 050308	○	24.5	25	34	174	96	118	56	1.4	27.3			
ATUM 25XD4 WCM. 050308	●	25	25	34	178	100	122	56	1.45	27.9			
ATUM 25.5XD4 WCM. 050308	○	25.5	25	34	178	100	122	56	1.45	28.4			
ATUM 26XD4 WCM. 050308	●	26	25	34	182	104	126	56	1.45	28.9			
ATUM 26.5XD4 WCM. 050308	●	26.5	25	34	182	104	126	56	1.45	29.4			
ATUM 27XD4 WCM. 050308	●	27	25	34	186	108	130	56	1.45	29.9			
ATUM 27.5XD4 WCM. 050308	○	27.5	25	34	186	108	130	56	1.45	30.4			
ATUM 28XD4 WCM. 050308	●	28	25	34	190	112	134	56	1.6	31.2			
ATUM 28.5XD4 WCM. 050308	●	28.5	25	34	190	112	134	56	1.6	31.7			
ATUM 29XD4 WCM. 050308	●	29	25	34	194	116	138	56	1.65	32.3			
ATUM 29.5XD4 WCM. 050308	○	29.5	25	34	194	116	138	56	1.65	32.8			

R: Sağ / Right / Правый L: Sol / Left / Левый
● Stokta / In Stock / В наличии ○ Stokta Yok / Non Stock Item / Нет в наличии
ISO Uçuna Uygundur. / Compatible with ISO Insert. / Под пластину ISO.

Sipariş Örneği/Ordering Example/Образец заказа
1 ad./pcs./шт. ATUM 16XD4 WCM. 030208

Takma Uçlu Matkap Kullanım Kılavuzu : S 367 / User's Guide For U-Drills : P 367 / Руководство для эксплуатации сверел: стр. 368



Delme Derinliği = 4x Çap
Drilling Depth = 4x Diameter
Глубина сверления = 4x Диаметр

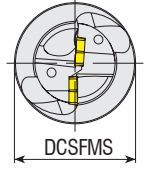
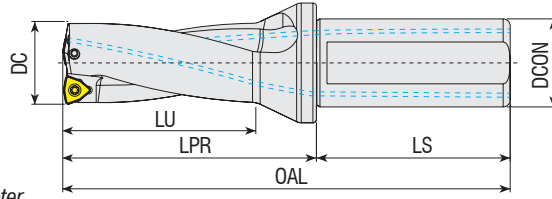

Takım Kodu
Ordering Code
Код для заказа

Takım Kodu Ordering Code Код для заказа	Stok Stock Наличие	Takım Ölçüleri (mm) Dimension (mm) Размеры (мм)							Maks. Ofset (radyal) Max. Offset (radial) Радиальное смещение		Kesici Uç Insert Пластина	Yedek Parçaları / Spare Parts / Запасные части	
		DC	DCON	DCSFMS	OAL	LU	LPR	LS	X _{max}	DC _{max} [mm]		Sıkma Vidası Screw Зажимной винт	Tork Anahtar Torx Key Торх Ключ
ATUM 30XD4 WCM. 06T308	●	30	32	44	207	120	147	60	2.4	34.8	WCM. 06T308	3010-M3.5x9	80-T10
ATUM 31XD4 WCM. 06T308	●	31	32	44	211	124	151	60	2.3	35.6			
ATUM 32XD4 WCM. 06T308	●	32	32	44	215	128	155	60	2.1	36.2			
ATUM 33XD4 WCM. 06T308	●	33	32	44	219	132	159	60	1.9	36.8			
ATUM 33.5XD4 WCM. 06T308	●	33.5	32	44	219	132	159	60	1.9	37.3			
ATUM 34XD4 WCM. 06T308	●	34	32	44	223	136	163	60	1.9	37.8			
ATUM 35XD4 WCM. 06T308	●	35	32	44	227	140	167	60	1.9	38.8			
ATUM 36XD4 WCM. 06T308	●	36	32	44	231	144	171	60	2	40			
ATUM 37XD4 WCM. 06T308	●	37	32	44	235	148	175	60	1.8	40.6			
ATUM 38XD4 WCM. 06T308	●	38	32	44	239	152	179	60	1.5	41			
ATUM 38.5XD4 WCM. 06T308	●	38.5	32	44	239	152	179	60	1.5	41.5			
ATUM 39XD4 WCM. 06T308	●	39	32	44	243	156	183	60	1.3	41.6			
ATUM 40XD4 WCM. 06T308	●	40	32	44	247	160	187	60	1	42			
ATUM 41XD4 WCM. 06T308	●	41	32	44	251	164	191	60	0.8	42.6			
ATUM 42XD4 WCM. 06T308	●	42	32	44	255	168	195	60	0.5	43			
ATUM 43XD4 WCM. 06T308	●	43	32	44	259	172	199	60	0.3	43.6			
ATUM 44XD4 WCM. 06T308	●	44	32	44	263	176	203	60	0	44			
ATUM 45XD4 WCM. 080412	●	45	40	54	282	180	212	70	3.3	51.6	WCM. 080412	4015-M4x11	80-T15
ATUM 46XD4 WCM. 080412	●	46	40	54	286	184	216	70	3	52			
ATUM 47XD4 WCM. 080412	●	47	40	54	290	188	220	70	2.8	52.6			
ATUM 48XD4 WCM. 080412	●	48	40	54	294	192	224	70	2.5	53			
ATUM 49XD4 WCM. 080412	●	49	40	54	298	196	228	70	2.2	53.4			
ATUM 50XD4 WCM. 080412	●	50	40	54	302	200	232	70	2	54			

R: Sağ / Right / Правый L: Sol / Left / Левый
● Stokta / In Stock / В наличии ○ Stokta Yok / Non Stock Item / Нет в наличии
ISO Ucuna Uygundur. / Compatible with ISO Insert. / Под пластину ISO.

Sipariş Örneği/Ordering Example/Образец заказа
1 ad./pcs./шт. ATUM 30XD4 WCM. 06T308

Takma Uçlu Matkap Kullanım Kılavuzu : S 367 / User's Guide For U-Drills : P 367 / Руководство для эксплуатации сверел: стр. 368



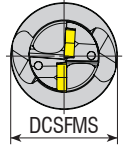
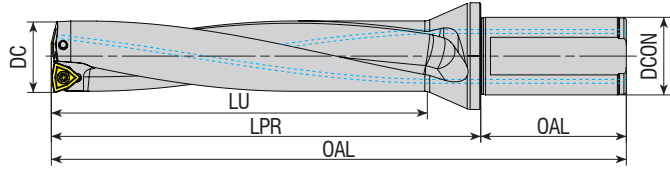

Delme Derinliği = 5x Çap
Drilling Depth = 5x Diameter
Глубина сверления = 5x Диаметр

Takım Kodu Ordering Code Код для заказа	Stok Stock Наличие	Takım Ölçüleri (mm) Dimension (mm) Размеры (мм)							Maks. Ofset (radyal) Max. Offset (radial) Радиальное смещение	Kesici Uç Insert Пластина	Yedek Parçaları / Spare Parts / Запасные части		
		DC	DCON	DCSFMS	OAL	LU	LPR	LS			Sıkma Vidası Screw Зажимной винт	Tork Anahtar Torx Key Торх Ключ	
ATUM 20XD5 WCM. 040208	●	20	25	34	178	100	122	56	1.5	23	WCM. 040208	3008-M2.5x6	80-T08
ATUM 21XD5 WCM. 040208	●	21	25	34	183	105	127	56	1	23			
ATUM 22XD5 WCM. 040208	●	22	25	34	188	110	132	56	1	24			
ATUM 23XD5 WCM. 040208	●	23	25	34	193	115	137	56	1	25	WCM. 050308	3008-M3x8	80-T08
ATUM 24XD5 WCM. 050308	●	24	25	34	198	120	142	56	1.4	26.8			
ATUM 25XD5 WCM. 050308	●	25	25	34	203	125	147	56	1.45	27.9			
ATUM 26XD5 WCM. 050308	●	26	25	34	208	130	152	56	1.45	28.9			
ATUM 27XD5 WCM. 050308	●	27	25	34	213	135	157	56	1.45	29.9			
ATUM 28XD5 WCM. 050308	●	28	25	34	218	140	162	56	1.6	31.2			
ATUM 29XD5 WCM. 050308	●	29	25	34	223	145	167	56	1.65	32.3	WCM. 06T308	3010-M3.5x9	80-T10
ATUM 30XD5 WCM. 06T308	●	30	32	44	237	150	177	60	2.4	34.8			
ATUM 31XD5 WCM. 06T308	●	31	32	44	242	155	182	60	2.3	35.6			
ATUM 32XD5 WCM. 06T308	●	32	32	44	247	160	187	60	2.1	36.2			
ATUM 33XD5 WCM. 06T308	●	33	32	44	252	165	192	60	1.9	36.8			
ATUM 34XD5 WCM. 06T308	●	34	32	44	257	170	197	60	1.9	37.8			
ATUM 35XD5 WCM. 06T308	●	35	32	44	262	175	202	60	1.9	38.8			
ATUM 37XD5 WCM. 06T308	●	37	32	44	272	185	212	60	1.8	40.6	WCM. 080412	4015-M4x11	80-T15
ATUM 38XD5 WCM. 06T308	●	38	32	44	277	190	217	60	1.5	41			
ATUM 46XD5 WCM. 080412	●	46	40	54	332	230	262	70	3	52			

R: Sağ / Right / Правый L: Sol / Left / Левый
● Stokta / In Stock / В наличии ○ Stokta Yok / Non Stock Item / Нет в наличии
ISO Uçuna Uygundur. / Compatible with ISO Insert. / Под пластину ISO.

Sipariş Örneği/Ordering Example/Образец заказа
1 ad./pcs./шт. ATUM 20XD5 WCM. 040208
Takma Uçlu Matkap Kullanım Kılavuzu : S 367 / User's Guide For U-Drills : P 367
Руководство для эксплуатации сверел: стр. 368



Delme Derinliği = 2x Çap
Drilling Depth = 2x Diameter
Глубина сверления = 2x Диаметр

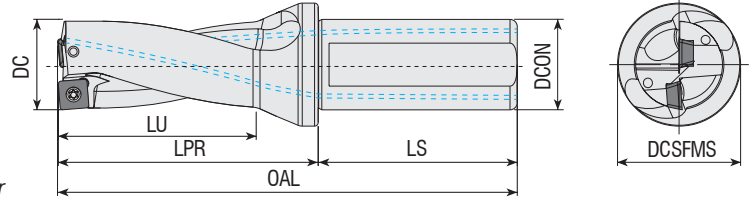

Takım Kodu
Ordering Code
Код для заказа

Takım Kodu Ordering Code Код для заказа	Stok Stock Наличие	Takım Ölçüleri (mm) Dimension (mm) Размеры (мм)							Maks. Ofset (radyal) Max. Offset (radial) Радиальное смещение		Kesici Uç Insert Пластина	Yedek Parçaları / Spare Parts / Запасные части	
		DC	DCON	DCSFMS	OAL	LU	LPR	LS	X_{max}	DC_{max} [mm]		Sıkma Vidası Screw Зажимной винт	Tork Anahtar Torx Key Торх Ключ
ATUM 12.5XD2 SP.. 050204	●	12.5	20	25	96	24	46	50	0.75	14	SP.. 050204	3006-M2x4	80-T06
ATUM 13XD2 SP.. 050204	●	13	20	25	98	26	48	50	0.75	14.5			
ATUM 13.5XD2 SP.. 050204	●	13.5	20	25	98	26	48	50	0.75	15			
ATUM 14XD2 SP.. 050204	●	14	20	25	100	28	50	50	0.6	15.2			
ATUM 14.5XD2 SP.. 050204	●	14.5	20	25	100	28	50	50	0.6	15.7			
ATUM 15XD2 SP.. 050204	●	15	20	25	102	30	52	50	0.5	16			
ATUM 15.5XD2 SP.. 060204	●	15.5	20	25	102	30	52	50	0.9	17.3	SP.. 060204	3007-M2.2x5	80-T07
ATUM 16XD2 SP.. 060204	●	16	25	34	110	32	54	56	0.8	17.6			
ATUM 16.5XD2 SP.. 060204	●	16.5	25	34	110	32	54	56	0.8	18.1			
ATUM 17XD2 SP.. 060204	●	17	25	34	112	34	56	56	0.75	18.5			
ATUM 17.5XD2 SP.. 060204	●	17.5	25	34	112	34	56	56	0.75	19			
ATUM 18XD2 SP.. 060204	●	18	25	34	114	36	58	56	0.5	19			
ATUM 18.5XD2 SP.. 060204	●	18.5	25	34	114	36	58	56	0.5	19.5			
ATUM 19XD2 SP.. 060204	●	19	25	34	116	38	60	56	0.3	19.6			
ATUM 19.5XD2 SP.. 060204	●	19.5	25	34	116	38	60	56	0.3	20.1			
ATUM 20XD2 SP.. 060204	●	20	25	34	118	40	62	56	0	20			
ATUM 20.5XD2 SP.. 060204	●	20.5	25	34	118	40	62	56	0	20.5			
ATUM 21XD2 SP.. 060204	●	21	25	34	120	42	64	56	0	21			
ATUM 21.5XD2 SP.. 060204	●	21.5	25	34	120	42	64	56	0	21.5			
ATUM 22XD2 SP.. 07T308	●	22	25	34	122	44	66	56	1	24	SP.. 07T308	3008-M2.5x6	80-T08
ATUM 22.5XD2 SP.. 07T308	●	22.5	25	34	122	44	66	56	1	24.5			
ATUM 23XD2 SP.. 07T308	●	23	25	34	124	46	68	56	0.75	24.5			
ATUM 23.5XD2 SP.. 07T308	●	23.5	25	34	124	46	68	56	0.75	25			
ATUM 24XD2 SP.. 07T308	●	24	25	34	126	48	70	56	0.5	25			
ATUM 24.5XD2 SP.. 07T308	●	24.5	25	34	126	48	70	56	0.5	25.5			
ATUM 25XD2 SP.. 07T308	●	25	25	34	128	50	72	56	0.25	25.5			
ATUM 25.5XD2 SP.. 07T308	●	25.5	25	34	128	50	72	56	0.25	26			
ATUM 26XD2 SP.. 07T308	●	26	25	34	130	52	74	56	0	26			
ATUM 26.5XD2 SP.. 07T308	●	26.5	25	34	130	52	74	56	0	26.5			
ATUM 27XD2 SP.. 07T308	●	27	25	34	132	54	76	56	0	27			
ATUM 27.5XD2 SP.. 07T308	●	27.5	25	34	132	54	76	56	0	27.5			

R: Sağ / Right / Правый L: Sol / Left / Левый

● Stokta / In Stock / В наличии ○ Stokta Yok / Non Stock Item / Нет в наличии

TGTC Ucuna Uygunudur. / Compatiple with TGTC Insert. / Под пластину TGTC.

Sipariş Örneği/Ordering Example/Образец заказа

1 ad./pcs./шт. ATUM 12.5XD2 SP.. 050204

Takma Uçlu Matkap Kullanım Kılavuzu : S 367 / User's Guide For U-Drills : P 367

Руководство для эксплуатации сверел: стр. 368



Delme Derinliği = 2x Çap
Drilling Depth = 2x Diameter
Глубина сверления = 2x Диаметр

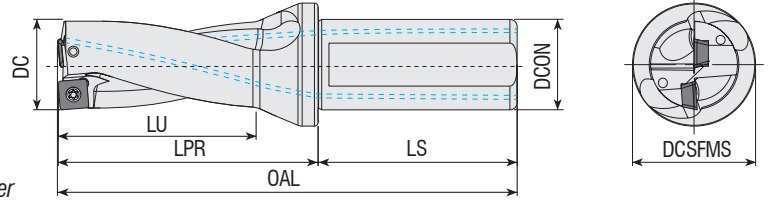

Takım Kodu Ordering Code Код для заказа	Stok Stock Наличие	Takım Ölçüleri (mm) Dimension (mm) Размеры (мм)							Maks. Offset (radyal) Max. Offset (radial) Радиальное смещение		Kesici Uç Insert Пластина	Yedek Parçaları / Spare Parts / Запасные части	
		DC	DCON	DCSFMS	OAL	LU	LPR	LS	X _{max} X _{max} [mm]	DC _{max} DC _{max} [mm]		Sıkma Vidası Screw Зажимной винт	Tork Anahtar Torx Key Торх Ключ
ATUM 28XD2 SP. 090408	●	28	25	34	134	56	78	56	1	30	SP. 090408	4015-M3.5x9	80-T15
ATUM 28.5XD2 SP. 090408	●	28.5	25	34	134	56	78	56	1	30.5			
ATUM 29XD2 SP. 090408	●	29	25	34	136	58	80	56	0.75	30.5			
ATUM 29.5XD2 SP. 090408	●	29.5	25	34	136	58	80	56	0.75	31			
ATUM 30XD2 SP. 090408	●	30	32	44	147	60	87	60	0.5	31			
ATUM 31XD2 SP. 090408	●	31	32	44	149	62	89	60	0.25	31.5			
ATUM 32XD2 SP. 090408	●	32	32	44	151	64	91	60	0	32			
ATUM 33XD2 SP. 090408	●	33	32	44	153	66	93	60	0	33			
ATUM 34XD2 SP. 110408	●	34	32	44	155	68	95	60	1	36	SP. 110408	4015-M4x11	80-T15
ATUM 35XD2 SP. 110408	●	35	32	44	157	70	97	60	0.75	36.5			
ATUM 36XD2 SP. 110408	●	36	32	44	159	72	99	60	0.6	37.2			
ATUM 37XD2 SP. 110408	●	37	32	44	161	74	101	60	0.5	38			
ATUM 38XD2 SP. 110408	●	38	32	44	163	76	103	60	0.25	38.5			
ATUM 39XD2 SP. 110408	●	39	32	44	165	78	105	60	0	39			
ATUM 40XD2 SP. 110408	●	40	32	44	167	80	107	60	0	40			
ATUM 41XD2 SP. 110408	●	41	32	44	169	82	109	60	0	41			
ATUM 42XD2 SP. 140512	●	42	32	44	171	84	111	60	1.2	44.4	SP. 140512	1020-M5x11	80-T20
ATUM 43XD2 SP. 140512	●	43	32	44	173	86	113	60	1	45			
ATUM 44XD2 SP. 140512	●	44	32	44	175	88	115	60	0.8	45.6			
ATUM 45XD2 SP. 140512	●	45	40	54	192	90	122	70	0.6	46.2			
ATUM 46XD2 SP. 140512	●	46	40	54	194	92	124	70	0.4	46.8			
ATUM 47XD2 SP. 140512	●	47	40	54	196	94	126	70	0.2	47.4			
ATUM 48XD2 SP. 140512	●	48	40	54	198	96	128	70	0	48			
ATUM 49XD2 SP. 140512	●	49	40	54	200	98	130	70	0	49			
ATUM 50XD2 SP. 140512	●	50	40	54	202	100	132	70	0	50			

R: Sağ / Right / Правый L: Sol / Left / Левый
● Stokta / In Stock / В наличии ○ Stokta Yok / Non Stock Item / Нет в наличии
TGTC Ucuna Uygunudur. / Compatible with TGTC Insert. / Под пластину TGTC.

Sipariş Örneği/Ordering Example/Образец заказа
1 ad./pcs./шт. ATUM 28XD2 SP. 090408

Takma Uçlu Matkap Kullanım Kılavuzu : S 367 / User's Guide For U-Drills : P 367
Руководство для эксплуатации сверел: стр. 368



Delme Derinliği = 3x Çap
Drilling Depth = 3x Diameter
Глубина сверления = 3x Диаметр

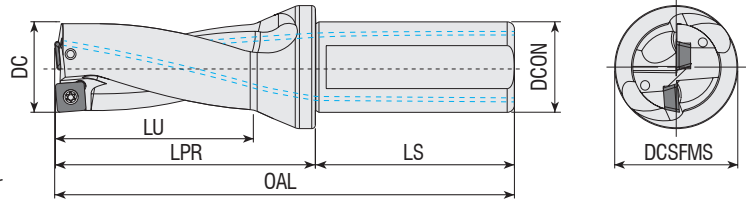

Takım Kodu
Ordering Code
Код для заказа

Takım Kodu Ordering Code Код для заказа	Stok Stock Наличие	Takım Ölçüleri (mm) Dimension (mm) Размеры (мм)							Maks. Ofset (radyal) Max. Offset (radial) Радиальное смещение		Kesici Uç Insert Пластина	Sıkma Vidası Screw Зажимной винт	Tork Anahtar Torx Key Торх Ключ
		DC	DCON	DCSFMS	OAL	LU	LPR	LS	X _{max} X _{max} [mm]	DC _{max} DC _{max} [mm]			
ATUM 12.5XD3 SP. 050204	●	12.5	20	25	108	36	58	50	0.75	14	SP. 050204	3006-M2x4	80-T06
ATUM 13XD3 SP. 050204	●	13	20	25	111	39	61	50	0.75	14.5			
ATUM 13.5XD3 SP. 050204	●	13.5	20	25	111	39	61	50	0.75	15			
ATUM 14XD3 SP. 050204	●	14	20	25	114	42	64	50	0.6	15.2			
ATUM 14.5XD3 SP. 050204	●	14.5	20	25	114	42	64	50	0.6	15.7			
ATUM 15XD3 SP. 050204	●	15	20	25	117	45	67	50	0.5	16			
ATUM 15.5XD3 SP. 060204	●	15.5	20	25	117	45	67	50	0.9	17.3			
ATUM 16XD3 SP. 060204	●	16	25	34	126	48	70	56	0.8	17.6			
ATUM 16.5XD3 SP. 060204	●	16.5	25	34	126	48	70	56	0.8	18.1			
ATUM 17XD3 SP. 060204	●	17	25	34	129	51	73	56	0.75	18.5			
ATUM 17.5XD3 SP. 060204	●	17.5	25	34	129	51	73	56	0.75	19			
ATUM 18XD3 SP. 060204	●	18	25	34	132	54	76	56	0.5	19			
ATUM 18.5XD3 SP. 060204	●	18.5	25	34	132	54	76	56	0.5	19.5			
ATUM 19XD3 SP. 060204	●	19	25	34	135	57	79	56	0.3	19.6			
ATUM 19.5XD3 SP. 060204	●	19.5	25	34	135	57	79	56	0.3	20.1			
ATUM 20XD3 SP. 060204	●	20	25	34	138	60	82	56	0	20			
ATUM 20.5XD3 SP. 060204	●	20.5	25	34	138	60	82	56	0	20.5			
ATUM 21XD3 SP. 060204	●	21	25	34	141	63	85	56	0	21			
ATUM 21.5XD3 SP. 060204	●	21.5	25	34	141	63	85	56	0	21.5			
ATUM 22XD3 SP. 07T308	●	22	25	34	144	66	88	56	1	24			
ATUM 22.5XD3 SP. 07T308	●	22.5	25	34	144	66	88	56	1	24.5			
ATUM 23XD3 SP. 07T308	●	23	25	34	147	69	91	56	0.75	24.5			
ATUM 23.5XD3 SP. 07T308	●	23.5	25	34	147	69	91	56	0.75	25			
ATUM 24XD3 SP. 07T308	●	24	25	34	150	72	94	56	0.5	25			
ATUM 24.5XD3 SP. 07T308	●	24.5	25	34	150	72	94	56	0.5	25.5			
ATUM 25XD3 SP. 07T308	●	25	25	34	153	75	97	56	0.25	25.5			
ATUM 25.5XD3 SP. 07T308	●	25.5	25	34	153	75	97	56	0.25	26			
ATUM 26XD3 SP. 07T308	●	26	25	34	156	78	100	56	0	26			
ATUM 26.5XD3 SP. 07T308	●	26.5	25	34	156	78	100	56	0	26.5			
ATUM 27XD3 SP. 07T308	●	27	25	34	159	81	103	56	0	27			
ATUM 27.5XD3 SP. 07T308	●	27.5	25	34	159	81	103	56	0	27.5			
ATUM 28XD3 SP. 090408	●	28	25	34	162	84	106	56	1	30			
ATUM 28.5XD3 SP. 090408	●	28.5	25	34	162	84	106	56	1	30.5			
ATUM 29XD3 SP. 090408	●	29	25	34	165	87	109	56	0.75	30.5			
ATUM 29.5XD3 SP. 090408	●	29.5	25	34	165	87	109	56	0.75	31			
ATUM 30XD3 SP. 090408	●	30	32	44	177	90	117	60	0.5	31			
ATUM 30.5XD3 SP. 090408	●	30.5	32	44	177	90	117	60	0.5	31.5			
ATUM 31XD3 SP. 090408	●	31	32	44	180	93	120	60	0.25	31.5			
ATUM 31.5XD3 SP. 090408	●	31.5	32	44	180	93	120	60	0.25	32			
ATUM 32XD3 SP. 090408	●	32	32	44	183	96	123	60	0	32			
ATUM 32.5XD3 SP. 090408	●	32.5	32	44	183	96	123	60	0	32.5			
ATUM 33XD3 SP. 090408	●	33	32	44	186	99	126	60	0	33			
ATUM 33.5XD3 SP. 090408	●	33.5	32	44	186	99	126	60	0	33.5			

R: Sağ / Right / Правый L: Sol / Left / Левый

● Stokta / In Stock / В наличии ○ Stokta Yok / Non Stock Item / Нет в наличии

TGTC Ucuna Uygundur. / Compatible with TGTC Insert. / Под пластину TGTC.

Sipariş Örneği/Ordering Example/Образец заказа

1 ad./pcs./шт. ATUM 12.5XD3 SP. 050204

Takma Uçlu Matkap Kullanım Kılavuzu : S 367 / User's Guide For U-Drills : P 367

Руководство для эксплуатации сверел: стр. 368



Delme Derinliği = 3x Çap
Drilling Depth = 3x Diameter
Глубина сверления = 3x Диаметр

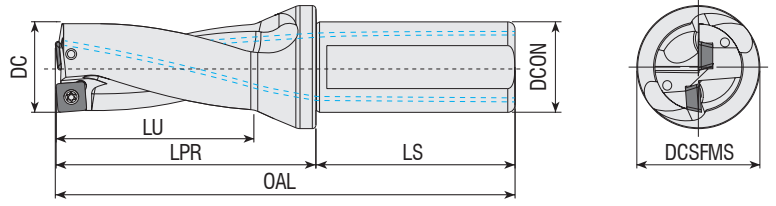

Takım Kodu Ordering Code Код для заказа	Stok Stock Наличие	Takım Ölçüleri (mm) Dimension (mm) Размеры (мм)							Maks. Ofset (radyal) Max. Offset (radial) Радиальное смещение		Kesici Uç Insert Пластина	Yedek Parçaları / Spare Parts / Запасные части		
		DC	DCON	DCSFMS	OAL	LU	LPR	LS	X_{max}	DC_{max}		Sıkma Vidası Screw Зажимной винт	Tork Anahtar Torx Key Торх Ключ	
														X_{max} [mm]
ATUM 34XD3 SP. 110408	●	34	32	44	189	102	129	60	1	36	SP. 110408	4015-M4x11	80-T15	
ATUM 34.5XD3 SP. 110408	●	34.5	32	44	189	102	129	60	1	36.5				
ATUM 35XD3 SP. 110408	●	35	32	44	192	105	132	60	0.75	36.5				
ATUM 35.5XD3 SP. 110408	●	35.5	32	44	192	105	132	60	0.75	37				
ATUM 36XD3 SP. 110408	●	36	32	44	195	108	135	60	0.6	37.2				
ATUM 36.5XD3 SP. 110408	●	36.5	32	44	195	108	135	60	0.6	37.7				
ATUM 37XD3 SP. 110408	●	37	32	44	198	111	138	60	0.5	38				
ATUM 37.5XD3 SP. 110408	●	37.5	32	44	198	111	138	60	0.5	38.5				
ATUM 38XD3 SP. 110408	●	38	32	44	201	114	141	60	0.25	38.5				
ATUM 38.5XD3 SP. 110408	●	38.5	32	44	201	114	141	60	0.25	39				
ATUM 39XD3 SP. 110408	●	39	32	44	204	117	144	60	0	39				
ATUM 39.5XD3 SP. 110408	●	39.5	32	44	204	117	144	60	0	39.5				
ATUM 40XD3 SP. 110408	●	40	32	44	207	120	147	60	0	40				
ATUM 40.5XD3 SP. 110408	●	40.5	32	44	207	120	147	60	0	40.5				
ATUM 41XD3 SP. 110408	●	41	32	44	210	123	150	60	0	41				
ATUM 41.5XD3 SP. 110408	●	41.5	32	44	210	123	150	60	0	41.5				
ATUM 42XD3 SP. 140512	●	42	32	44	213	126	153	60	1.2	44.4	SP. 140512	1020-M5x11	80-T20	
ATUM 42.5XD3 SP. 140512	●	42.5	32	44	213	126	153	60	1.2	44.9				
ATUM 43XD3 SP. 140512	●	43	32	44	216	129	156	60	1	45				
ATUM 43.5XD3 SP. 140512	●	43.5	32	44	216	129	156	60	1	45.5				
ATUM 44XD3 SP. 140512	●	44	32	44	219	132	159	60	0.8	45.6				
ATUM 44.5XD3 SP. 140512	●	44.5	32	44	219	132	159	60	0.8	46.1				
ATUM 45XD3 SP. 140512	●	45	40	54	237	135	167	70	0.6	46.2				
ATUM 45.5XD3 SP. 140512	●	45.5	40	54	237	135	167	70	0.6	46.7				
ATUM 46XD3 SP. 140512	●	46	40	54	240	138	170	70	0.4	46.8				
ATUM 47XD3 SP. 140512	●	47	40	54	243	141	173	70	0.2	47.4				
ATUM 48XD3 SP. 140512	●	48	40	54	246	144	176	70	0	48				
ATUM 49XD3 SP. 140512	●	49	40	54	249	147	179	70	0	49				
ATUM 50XD3 SP. 140512	●	50	40	54	252	150	182	70	0	50				
ATUM 51XD3 SP. 140512	●	51	40	54	255	153	185	70	0	51				
ATUM 52XD3 SP. 140512	●	52	40	54	258	156	188	70	0	52				

R: Sağ / Right / Правый L: Sol / Left / Левый
● Stokta / In Stock / В наличии ○ Stokta Yok / Non Stock Item / Нет в наличии
TGTC Uçuna Uygundur. / Compatible with TGTC Insert. / Под пластину TGTC.

Sipariş Örneği/Ordering Example/Образец заказа
1 ad./pcs./шт. ATUM 34XD3 SP. 110408

Takma Uçlu Matkap Kullanım Kılavuzu : S 367 / User's Guide For U-Drills : P 367
Руководство для эксплуатации сверел: стр. 368



Delme Derinliği = 4x Çap
Drilling Depth = 4x Diameter
Глубина сверления = 4x Диаметр

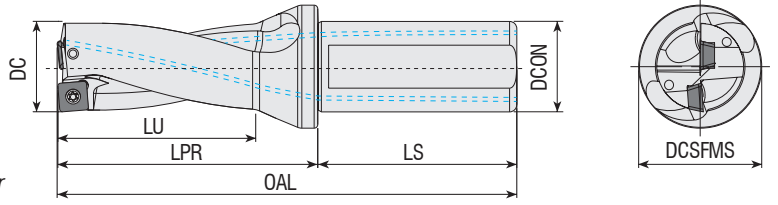

Takım Kodu
Ordering Code
Код для заказа

Takım Kodu Ordering Code Код для заказа	Stok Stock Наличие	Takım Ölçüleri (mm) Dimension (mm) Размеры (мм)								Maks. Ofset (radyal) Max. Offset (radial) Радиальное смещение		Kesici Uç Insert Пластина	Sıkma Vidası Screw Зажимной винт	Tork Anahtar Torx Key Торх Ключ
		DC	DCON	DCSEMS	OAL	LU	LPR	LS	X _{max}	DC _{max}				
ATUM 13XD4 SP. 050204	●	13	20	25	124	52	74	50	0.75	14.5	SP. 050204	3006-M2x4	80-T06	
ATUM 14XD4 SP. 050204	●	14	20	25	128	56	78	50	0.6	15.2				
ATUM 15XD4 SP. 050204	●	15	20	25	132	60	82	50	0.5	16				
ATUM 16XD4 SP. 060204	●	16	25	34	142	64	86	56	0.8	17.6	SP. 060204	3007-M2.2x5	80-T07	
ATUM 17XD4 SP. 060204	●	17	25	34	146	68	90	56	0.75	18.5				
ATUM 17.5XD4 SP. 060204	●	17.5	25	34	146	68	90	56	0.75	19				
ATUM 18XD4 SP. 060204	●	18	25	34	150	72	94	56	0.5	19				
ATUM 19XD4 SP. 060204	●	19	25	34	154	76	98	56	0.3	19.6				
ATUM 19.5XD4 SP. 060204	●	19.5	25	34	154	76	98	56	0.3	20.1				
ATUM 20XD4 SP. 060204	●	20	25	34	158	80	102	56	0	20				
ATUM 21XD4 SP. 060204	●	21	25	34	162	84	106	56	0	21	SP. 07T308	3008-M2.5x6	80-T08	
ATUM 22XD4 SP. 07T308	●	22	25	34	166	88	110	56	1	24				
ATUM 23XD4 SP. 07T308	●	23	25	34	170	92	114	56	0.75	24.5				
ATUM 23.5XD4 SP. 07T308	●	23.5	25	34	170	92	114	56	0.75	25				
ATUM 24XD4 SP. 07T308	●	24	25	34	174	96	118	56	0.5	25				
ATUM 25XD4 SP. 07T308	●	25	25	34	178	100	122	56	0.25	25.5				
ATUM 26XD4 SP. 07T308	●	26	25	34	182	104	126	56	0	26				
ATUM 27XD4 SP. 07T308	●	27	25	34	186	108	130	56	0	27	SP. 090408	4015-M3.5x9	80-T15	
ATUM 27.5XD4 SP. 07T308	●	27.5	25	34	186	108	130	56	0	27.5				
ATUM 28XD4 SP. 090408	●	28	25	34	190	112	134	56	1	30				
ATUM 29XD4 SP. 090408	●	29	25	34	194	116	138	56	0.75	30.5				
ATUM 30XD4 SP. 090408	●	30	32	44	207	120	147	60	0.5	31				
ATUM 31XD4 SP. 090408	●	31	32	44	211	124	151	60	0.25	31.5				
ATUM 32XD4 SP. 090408	●	32	32	44	215	128	155	60	0	32				
ATUM 33XD4 SP. 090408	●	33	32	44	219	132	159	60	0	33	SP. 110408	4015-M4x11	80-T15	
ATUM 33.5XD4 SP. 090408	●	33.5	32	44	219	132	159	60	0	33.5				
ATUM 34XD4 SP. 110408	●	34	32	44	223	136	163	60	1	36				
ATUM 35XD4 SP. 110408	●	35	32	44	227	140	167	60	0.75	36.5				
ATUM 36XD4 SP. 110408	●	36	32	44	231	144	171	60	0.6	37.2				
ATUM 37XD4 SP. 110408	●	37	32	44	235	148	175	60	0.5	38				
ATUM 38XD4 SP. 110408	●	38	32	44	239	152	179	60	0.25	38.5				
ATUM 39XD4 SP. 110408	●	39	32	44	243	156	183	60	0	39	SP. 140512	1020-M5x11	80-T20	
ATUM 40XD4 SP. 110408	●	40	32	44	247	160	187	60	0	40				
ATUM 41XD4 SP. 110408	●	41	32	44	251	164	191	60	0	41				
ATUM 42XD4 SP. 140512	●	42	32	44	255	168	195	60	1.2	44.4				
ATUM 43XD4 SP. 140512	●	43	32	44	259	172	199	60	1	45				
ATUM 44XD4 SP. 140512	●	44	32	44	263	176	203	60	0.8	45.6				

R: Sağ / Right / Правый L: Sol / Left / Левый
● Stokta / In Stock / В наличии ○ Stokta Yok / Non Stock Item / Нет в наличии
TGTC Ucuna Uygunudur. / Compatiple with TGTC Insert. / Под пластину TGTC.

Sipariş Örneği/Ordering Example/Образец заказа
1 ad./pcs./шт. ATUM 13XD4 SP. 050204
Takma Uçlu Matkap Kullanım Kılavuzu : S 367 / User's Guide For U-Drills : P 367
Руководство для эксплуатации сверел: стр. 368

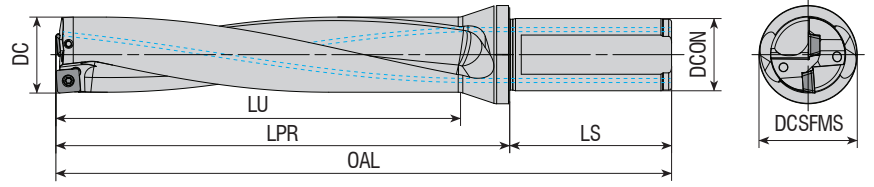

Delme Derinliđi = 5x Çap
Drilling Depth = 5x Diameter
Глубина сверления = 5x Диаметр

Takım Kodu Ordering Code Код для заказа	Stok Stock Наличие	Takım Ölçüleri (mm) Dimension (mm) Размеры (мм)							Maks. Ofset (radyal) Max. Offset (radial) Радиальное смещение		Kesici Uç Insert Пластина	Yedek Parçaları / Spare Parts / Запасные части	
		DC	DCON	DCSFMS	OAL	LU	LPR	LS	X _{max} X _{max} [mm]	DC _{max} DC _{max} [mm]		Sıkma Vidası Screw Зажимной винт	Tork Anahtar Torx Key Торх Ключ
ATUM 14XD5 SP. 050204	●	14	20	25	142	70	92	50	0.6	15.2	SP. 050204	3006-M2x4	80-T06
ATUM 16XD5 SP. 060204	●	16	25	34	158	80	102	56	0.8	17.6			
ATUM 17XD5 SP. 060204	●	17	25	34	163	85	107	56	0.75	18.5			
ATUM 18XD5 SP. 060204	●	18	25	34	168	90	112	56	0.5	19			
ATUM 19XD5 SP. 060204	●	19	25	34	173	95	117	56	0.3	19.6			
ATUM 20XD5 SP. 060204	●	20	25	34	178	100	122	56	0	20			
ATUM 21XD5 SP. 060204	●	21	25	34	183	105	127	56	0	21	SP. 060204	3007-M2.2x5	80-T07
ATUM 22XD5 SP. 07T308	●	22	25	34	188	110	132	56	1	24			
ATUM 22XD5 SP. 07T308-32	●	22	32	44	197	110	137	60	1	24			
ATUM 23XD5 SP. 07T308	●	23	25	34	193	115	137	56	0.75	24.5			
ATUM 23XD5 SP. 07T308-32	●	23	32	44	202	115	142	60	0.75	24.5			
ATUM 24XD5 SP. 07T308-32	●	24	32	44	207	120	147	60	0.5	25			
ATUM 25XD5 SP. 07T308	●	25	25	34	203	125	147	56	0.25	25.5	SP. 07T308	3008-M2.5x6	80-T08
ATUM 25XD5 SP. 07T308-32	●	25	32	44	212	125	152	60	0.25	25.5			
ATUM 26XD5 SP. 07T308	●	26	25	34	208	130	152	56	0	26			
ATUM 26XD5 SP. 07T308-32	●	26	32	44	217	130	157	60	0	26			
ATUM 27XD5 SP. 07T308	●	27	25	34	213	135	157	56	0	27			
ATUM 27XD5 SP. 07T308-32	●	27	32	44	222	135	162	60	0	27			
ATUM 28XD5 SP. 090408-32	●	28	32	44	227	140	167	60	1	30	SP. 090408	4015-M3.5x9	80-T15
ATUM 29XD5 SP. 090408-32	●	29	32	44	232	145	172	60	0.75	30.5			
ATUM 30XD5 SP. 090408	●	30	32	44	237	150	177	60	0.5	31			
ATUM 31XD5 SP. 090408	●	31	32	44	242	155	182	60	0.25	31.5			
ATUM 32XD5 SP. 090408	●	32	32	44	247	160	187	60	0	32			
ATUM 33XD5 SP. 090408	●	33	32	44	252	165	192	60	0	33			

R: Sağ / Right / Правый L: Sol / Left / Левый
● Stokta / In Stock / В наличии ○ Stokta Yok / Non Stock Item / Нет в наличии
TGTC Ucuna Uygunudur. / Compatible with TGTC Insert. / Под пластину TGTC.

Sipariş Örneđi/Ordering Example/Образец заказа
1 ad./pcs./шт. ATUM 14XD5 SP. 050204
Takma Uçlu Matkap Kullanım Kılavuzu : S 367 / User's Guide For U-Drills : P 367
Руководство для эксплуатации сверел: стр. 368



Delme Derinliği = 2x Çap
Drilling Depth = 2x Diameter
Глубина сверления = 2x Диаметр

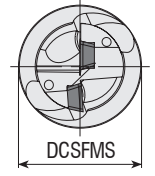
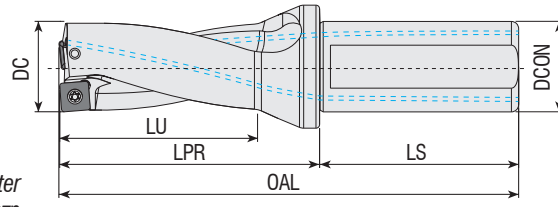

Takım Kodu
Ordering Code
Код для заказа

Stok Stock Наличие	Takım Ölçüleri (mm) Dimension (mm) Размеры (мм)								Maks. Ofset (radyal) Max. Offset (radial) Радиальное смещение		Kesici Uç Insert Пластина	Yedek Parçaları / Spare Parts / Запасные части	
	DC	DCON	DCSFMS	OAL	LU	LPR	LS	X _{max}	DC _{max}	Sıkma Vidası Screw Зажимной винт		Tork Anahtar Torx Key Торх Ключ	
●	12.5	20	25	96	24	46	50	0.75	14	SPGT 050204	3006-M2x4	80-T06	
●	13	20	25	98	26	48	50	0.75	14.5				
●	13.5	20	25	98	26	48	50	0.75	15				
●	14	20	25	100	28	50	50	0.6	15.2				
●	15	20	25	102	30	52	50	0.5	16				
●	16	25	34	110	32	54	56	0.8	17.6	SPGT 060204	3007-M2.2x5	80-T07	
●	16.5	25	34	110	32	54	56	0.8	18.1				
●	17	25	34	112	34	56	56	0.75	18.5				
●	17.5	25	34	112	34	56	56	0.75	19				
●	18	25	34	114	36	58	56	0.5	19				
●	19	25	34	116	38	60	56	0.3	19.6	SPGT 07T308	3008-M2.5x6	80-T08	
●	20	25	34	118	40	62	56	0	20				
●	22	25	34	122	44	66	56	1	24				
●	22.5	25	34	122	44	66	56	1	24.5				
●	23	25	34	124	46	68	56	0.75	24.5				
●	24	25	34	126	48	70	56	0.5	25	SPGT 090408	4015-M3.5x9	80-T15	
●	25	25	34	128	50	72	56	0.25	25.5				
●	26	25	34	130	52	74	56	0	26				
●	28	25	34	134	56	78	56	1	30				
●	29	25	34	136	58	80	56	0.75	30.5				
●	30	32	44	147	60	87	60	0.5	31	SPGT 110408	4015-M4x11	80-T15	
●	32	32	44	151	64	91	60	0	32				
●	35	32	44	157	70	97	60	0.75	36.5				
●	36	32	44	159	72	99	60	0.6	37.2				
●	40	32	44	167	80	107	60	0	40				

R: Sağ / Right / Правый L: Sol / Left / Левый
● Stokta / In Stock / В наличии ○ Stokta Yok / Non Stock Item / Нет в наличии
ZCC Uçuna Uygundur. / Compatible with ZCC Insert. / Под пластину ZCC.

Sipariş Örneği/Ordering Example/Образец заказа
1 ad./pcs./шт. ATUM 12.5XD2 SPGT 050204
Takma Uçlu Matkap Kullanım Kılavuzu : S 367 / User's Guide For U-Drills : P 367
Руководство для эксплуатации сверел: стр. 368





Delme Derinliği = 3x Çap
Drilling Depth = 3x Diameter
Глубина сверления = 3x Диаметр

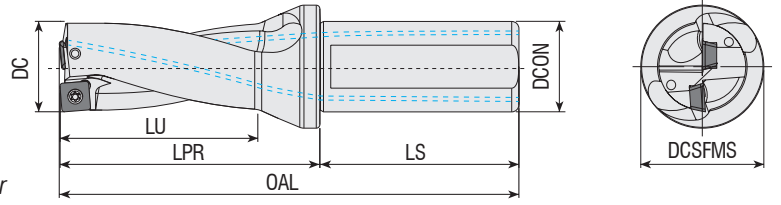

Takım Kodu
Ordering Code
Код для заказа

Stok Stock Наличие	Takım Ölçüleri (mm) Dimension (mm) Размеры (мм)								Maks. Ofset (radyal) Max. Offset (radial) Радиальное смещение		Kesici Uç Insert Пластина	Yedek Parçaları / Spare Parts / Запасные части	
	DC	DCON	DCSFMS	OAL	LU	LPR	LS	X _{max}	DC _{max} [mm]	Sıkma Vidası Screw Зажимной винт		Tork Anahtar Torx Key Торх Ключ	
●	12.5	20	25	108	36	58	50	0.75	14	SPGT 050204	3006-M2x4	80-T06	
●	13	20	25	111	39	61	50	0.75	14.5				
●	13.5	20	25	111	39	61	50	0.75	15				
●	14	20	25	114	42	64	50	0.6	15.2				
●	14.5	20	25	114	42	64	50	0.6	15.7				
●	15	20	25	117	45	67	50	0.5	16				
●	15.5	20	25	117	45	67	50	0.9	17.3	SPGT 060204	3007-M2.2x5	80-T07	
●	16	25	34	126	48	70	56	0.8	17.6				
●	16.5	25	34	126	48	70	56	0.8	18.1				
●	17	25	34	129	51	73	56	0.75	18.5				
●	17.5	25	34	129	51	73	56	0.75	19				
●	18	25	34	132	54	76	56	0.5	19				
●	18.5	25	34	132	54	76	56	0.5	19.5				
●	19	25	34	135	57	79	56	0.3	19.6				
●	19.5	25	34	135	57	79	56	0.3	20.1				
●	20	25	34	138	60	82	56	0	20				
●	20.5	25	34	138	60	82	56	0	20.5				
●	21	25	34	141	63	85	56	0	21				
●	21.5	25	34	141	63	85	56	0	21.5				
●	22	25	34	144	66	88	56	1	24	SPGT 07T308	3008-M2.5x6	80-T08	
●	22.5	25	34	144	66	88	56	1	24.5				
●	23	25	34	147	69	91	56	0.75	24.5				
●	23.5	25	34	147	69	91	56	0.75	25				
●	24	25	34	150	72	94	56	0.5	25				
●	24.5	25	34	150	72	94	56	0.5	25.5				
●	25	25	34	153	75	97	56	0.25	25.5				
●	25.5	25	34	153	75	97	56	0.25	26				
●	26	25	34	156	78	100	56	0	26				
●	26.5	25	34	156	78	100	56	0	26.5				
●	27	25	34	159	81	103	56	0	27				
●	27.5	25	34	159	81	103	56	0	27.5				
●	28	25	34	162	84	106	56	1	30	SPGT 090408	4015-M3.5x9	80-T15	
●	28.5	25	34	162	84	106	56	1	30.5				
●	29	25	34	165	87	109	56	0.75	30.5				
●	29.5	25	34	165	87	109	56	0.75	31				
●	30	32	44	177	90	117	60	0.5	31				
●	31	32	44	180	93	120	60	0.25	31.5				
●	32	32	44	183	96	123	60	0	32				
●	33	32	44	186	99	126	60	0	33				

R: Sağ / Right / Правый L: Sol / Left / Левый

● Stokta / In Stock / В наличии ○ Stokta Yok / Non Stock Item / Нет в наличии
ZCC Uçuna Uygundur. / Compatible with ZCC Insert. / Под пластину ZCC.

Sipariş Örneği/Ordering Example/Образец заказа

1 ad./pcs./шт. ATUM 12.5XD3 SPGT 050204

Takma Uçlu Matkap Kullanım Kılavuzu : S 367 / User's Guide For U-Drills : P 367

Руководство для эксплуатации сверел: стр. 368



Delme Derinliği = 3x Çap
Drilling Depth = 3x Diameter
Глубина сверления = 3x Диаметр

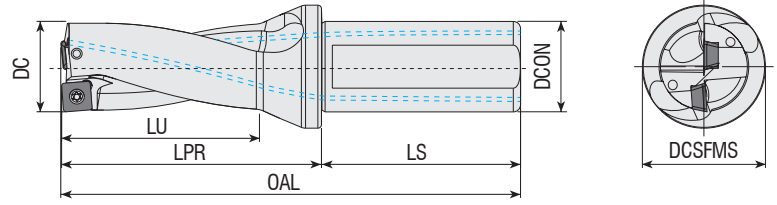

Takım Kodu
Ordering Code
Код для заказа

Takım Kodu Ordering Code Код для заказа	Stok Stock Наличие	Takım Ölçüleri (mm) Dimension (mm) Размеры (мм)							Maks. Offset (radyal) Max. Offset (radial) Радиальное смещение	Kesici Uç Insert Пластина	Yedek Parçaları / Spare Parts / Запасные части		
		DC	DCON	DCSFMS	OAL	LU	LPR	LS			Sikma Vidası Screw Зажимной винт	Tork Anahtar Torx Key Торх Ключ	
ATUM 34XD3 SPGT 110408	●	34	32	44	189	102	129	60	1	36	SPGT 110408	4015-M4x11	80-T15
ATUM 35XD3 SPGT 110408	●	35	32	44	192	105	132	60	0.75	36.5			
ATUM 37XD3 SPGT 110408	●	37	32	44	198	111	138	60	0.5	38			
ATUM 38XD3 SPGT 110408	●	38	32	44	201	114	141	60	0.25	38.5			
ATUM 39XD3 SPGT 110408	●	39	32	44	204	117	144	60	0	39			
ATUM 40XD3 SPGT 110408	●	40	32	44	207	120	147	60	0	40			
ATUM 42XD3 SPGT 140512	●	42	32	44	213	126	153	60	1.2	44.4	SPGT 140512	1020-M5x11	80-T20
ATUM 43XD3 SPGT 140512	●	43	32	44	216	129	156	60	1	45			
ATUM 44XD3 SPGT 140512	●	44	32	44	219	132	159	60	0.8	45.6			
ATUM 49XD3 SPGT 140512	●	49	40	54	249	147	179	70	0	49			
ATUM 50XD3 SPGT 140512	●	50	40	54	252	150	182	70	0	50			

R: Sağ / Right / Правый L: Sol / Left / Левый

● Stokta / In Stock / В наличии ○ Stokta Yok / Non Stock Item / Нет в наличии
ZCC Ucuna Uygun / Compatible with ZCC Insert. / Под пластину ZCC.

Sipariş Örneği/Ordering Example/Образец заказа
1 ad./pcs./шт. ATUM 34XD3 SPGT 110408

Takma Uçlu Matkap Kullanım Kılavuzu : S 367 / User's Guide For U-Drills : P 367
Руководство для эксплуатации сверел: стр. 368





Delme Derinliği = 4x Çap
Drilling Depth = 4x Diameter
Глубина сверления = 4x Диаметр

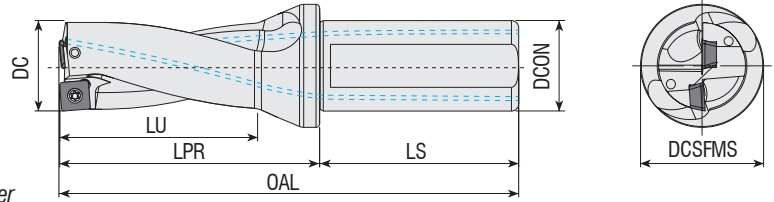

Takım Kodu Ordering Code Код для заказа	Stok Stock Наличие	Takım Ölçüleri (mm) Dimension (mm) Размеры (мм)							Maks. Ofset (radyal) Max. Offset (radial) Радиальное смещение		Kesici Uç Insert Пластина	Yedek Parçaları / Spare Parts / Запасные части		
		DC	DCON	DCSFMS	OAL	LU	LPR	LS	X _{max}	DC _{max}		Sıkma Vidası Screw Зажимной винт	Tork Anahtar Torx Key Торх Ключ	
ATUM 13XD4 SPGT 050204	●	13	20	25	124	52	74	50	0.75	14.5	SPGT 050204	3006-M2x4	80-T06	
ATUM 14XD4 SPGT 050204	●	14	20	25	128	56	78	50	0.6	15.2				
ATUM 15XD4 SPGT 050204	●	15	20	25	132	60	82	50	0.5	16				
ATUM 16XD4 SPGT 060204	●	16	25	34	142	64	86	56	0.8	17.6				
ATUM 17XD4 SPGT 060204	●	17	25	34	146	68	90	56	0.75	18.5	SPGT 060204	3007-M2.2x5	80-T07	
ATUM 17.5XD4 SPGT 060204	●	17.5	25	34	146	68	90	56	0.75	19				
ATUM 18XD4 SPGT 060204	●	18	25	34	150	72	94	56	0.5	19				
ATUM 19XD4 SPGT 060204	●	19	25	34	154	76	98	56	0.3	19.6				
ATUM 19.5XD4 SPGT 060204	●	19.5	25	34	154	76	98	56	0.3	20.1				
ATUM 20XD4 SPGT 060204	●	20	25	34	158	80	102	56	0	20				
ATUM 21XD4 SPGT 060204	●	21	25	34	162	84	106	56	0	21	SPGT 07T308	3008-M2.5x6	80-T08	
ATUM 22XD4 SPGT 07T308	●	22	25	34	166	88	110	56	1	24				
ATUM 23XD4 SPGT 07T308	●	23	25	34	170	92	114	56	0.75	24.5				
ATUM 23.5XD4 SPGT 07T308	●	23.5	25	34	170	92	114	56	0.75	25				
ATUM 24XD4 SPGT 07T308	●	24	25	34	174	96	118	56	0.5	25				
ATUM 25XD4 SPGT 07T308	●	25	25	34	178	100	122	56	0.25	25.5				
ATUM 26XD4 SPGT 07T308	●	26	25	34	182	104	126	56	0	26	SPGT 090408	4015-M3.5x9	80-T15	
ATUM 27.5XD4 SPGT 07T308	●	27.5	25	34	186	108	130	56	0	27.5				
ATUM 28XD4 SPGT 090408	●	28	25	34	190	112	134	56	1	30				
ATUM 29XD4 SPGT 090408	●	29	25	34	194	116	138	56	0.75	30.5				
ATUM 30XD4 SPGT 090408	●	30	32	44	207	120	147	60	0.5	31	SPGT 090408	4015-M3.5x9	80-T15	
ATUM 33.5XD4 SPGT 090408	●	33.5	32	44	219	132	159	60	0	33.5				
ATUM 38XD4 SPGT 110408	●	38	32	44	239	152	179	60	0.25	38.5	SPGT 110408	4015-M4x11	80-T15	

R: Sağ / Right / Правый L: Sol / Left / Левый
● Stokta / In Stock / В наличии ○ Stokta Yok / Non Stock Item / Нет в наличии
ZCC Ucuna Uygunudur. / Compatiple with ZCC Insert. / Под пластину ZCC.

Sipariş Örneği/Ordering Example/Образец заказа
1 ad./pcs./шт. ATUM 13XD4 SPGT 050204

Takma Uçlu Matkap Kullanım Kılavuzu : S 367 / User's Guide For U-Drills : P 367
Руководство для эксплуатации сверел: стр. 368





Delme Derinliği = 3x Çap
Drilling Depth = 3x Diameter
Глубина сверления = 3x Диаметр

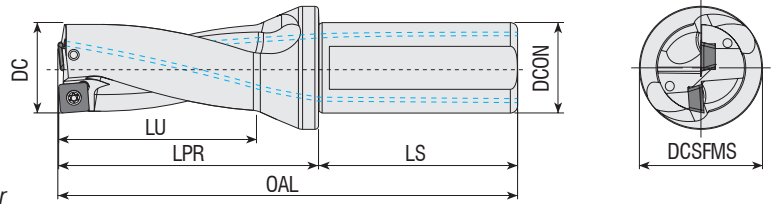

Takım Kodu
Ordering Code
Код для заказа

Takım Kodu Ordering Code Код для заказа	Stok Stock Наличие	Takım Ölçüleri (mm) Dimension (mm) Размеры (мм)							Maks. Ofset (radyal) Max. Offset (radial) Радиальное смещение		Kesici Uç Insert Пластина	Yedek Parçaları / Spare Parts / Запасные части	
		DC	DCON	DCSFMS	OAL	LU	LPR	LS	X _{max} X _{max} [mm]	DC _{max} DC _{max} [mm]		Sıkma Vidası Screw Зажимной винт	Tork Anahtar Torx Key Торх Ключ
ATUM 14XD3 SO.. 050204	●	14	20	25	114	42	64	50	1.4	16.8	SO.. 050204	3006-M2x4	80-T06
ATUM 15XD3 SO.. 050204	●	15	20	25	117	45	67	50	1.2	17.4			
ATUM 16XD3 SO.. 050204	●	16	25	34	126	48	70	56	0.9	17.8			
ATUM 16.5XD3 SO.. 050204	●	16.5	25	34	126	48	70	56	0.8	18.1			
ATUM 17XD3 SO.. 050204	●	17	25	34	129	51	73	56	0.65	18.3			
ATUM 17.5XD3 SO.. 050204	●	17.5	25	34	129	51	73	56	0.5	18.5			
ATUM 18XD3 SO.. 060304	●	18	25	34	132	54	76	56	1.15	20.3	SO.. 060304	3007-M2.2x5	80-T07
ATUM 19XD3 SO.. 060204	●	19	25	34	135	57	79	56	0.9	20.8			
ATUM 20XD3 SO.. 060304	●	20	25	34	138	60	82	56	0.65	21.3			
ATUM 21XD3 SO.. 070305	●	21	25	34	141	63	85	56	1.75	24.5	SO.. 070305	3008-M2.5x6	80-T08
ATUM 22XD3 SO.. 070305	●	22	25	34	144	66	88	56	1.5	25			
ATUM 22.5XD3 SO.. 070305	●	22.5	25	34	144	66	88	56	1.35	25.2			
ATUM 23XD3 SO.. 070305	●	23	25	34	147	69	91	56	1.25	25.5			
ATUM 24XD3 SO.. 070305	●	24	25	34	150	72	94	56	1	26			
ATUM 25XD3 SO.. 09T306	●	25	25	34	153	75	97	56	2.25	29.5			
ATUM 26XD3 SO.. 09T306	●	26	25	34	156	78	100	56	2	30	SO.. 09T306	4010-M3x8	80-T10
ATUM 27XD3 SO.. 09T306	●	27	25	34	159	81	103	56	1.75	30.5			
ATUM 29XD3 SO.. 09T306	●	29	25	34	174	87	114	56	1.25	31.5			
ATUM 30XD3 SO.. 09T306	●	30	32	44	177	90	117	60	1	32			
ATUM 31XD3 SO.. 09T306	●	31	32	44	200	93	120	60	0.75	32.5			
ATUM 33XD3 SO.. 09T306	●	33	32	44	186	99	126	60	0.5	34			
ATUM 35XD3 SO.. 120408	●	35	32	44	192	105	132	60	2.75	40.5	SO..120408	4015-M4X11	80-T15
ATUM 36XD3 SO.. 120408	●	36	32	44	195	108	135	60	2.5	41			
ATUM 37XD3 SO.. 120408	●	37	32	44	198	111	138	60	2.25	41.5			
ATUM 38XD3 SO.. 120408	●	38	32	44	201	114	141	60	1.75	41.5			
ATUM 39XD3 SO.. 120408	●	39	32	44	204	117	144	60	1.75	42.5			
ATUM 40XD3 SO.. 120408	●	40	32	44	207	120	147	60	1.5	43			
ATUM 43XD3 SO.. 120408	●	43	32	44	216	129	156	60	0.75	44.5			

R: Sağ / Right / Правый L: Sol / Left / Левый
● Stokta / In Stock / В наличии ○ Stokta Yok / Non Stock Item / Нет в наличии
ISCR Uçuna Uygun / Compatiple with ISCR Insert. / Под пластину ISCR

Sipariş Örneği/Ordering Example/Образец заказа
1 ad./pcs./шт. ATUM 14XD3 SO.. 050204
Takma Uçlu Matkap Kullanım Kılavuzu : S 367 / User's Guide For U-Drills : P 367
Руководство для эксплуатации сверел: стр. 368



Delme Derinliği = 4x Çap
Drilling Depth = 4x Diameter
Глубина сверления = 4x Диаметр

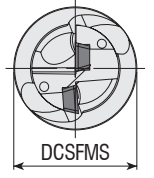
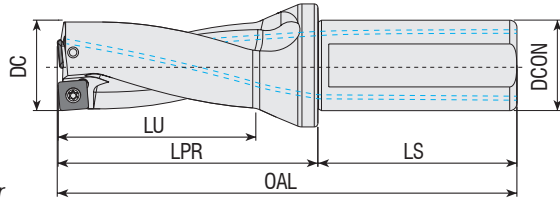

Takım Kodu Ordering Code Код для заказа	Stok Stock Наличие	Takım Ölçüleri (mm) Dimension (mm) Размеры (мм)								Maks. Ofset (radyal) Max. Offset (radial) Радиальное смещение		Kesici Uç Insert Пластина	Yedek Parçaları / Spare Parts / Запасные части	
		DC	DCON	DCSFMS	OAL	LU	LPR	LS	X _{max}	DC _{max}	Sıkma Vidası Screw Зажимной винт		Tork Anahtar Torx Key Торх Ключ	
ATUM 14XD4 SO.. 050204	●	14	20	25	128	56	78	50	1.4	16.8	SO.. 050204	3006-M2x4	80-T06	
ATUM 14.5XD4 SO.. 050204	●	14.5	20	25	128	56	78	50	1.3	17.1				
ATUM 15XD4 SO.. 050204	●	15	20	25	132	60	62	50	1.2	17.4				
ATUM 15.5XD4 SO.. 050204	●	15.5	20	25	132	60	82	50	1	17.5				
ATUM 17XD4 SO.. 050204	●	17	25	34	146	68	90	56	0.65	18.3				
ATUM 19XD4 SO.. 060304	●	19	25	34	154	76	98	56	0.9	20.8	SO.. 060304	3007-M2.2x5	80-T07	
ATUM 19.5XD4 SO.. 060304	●	19.5	25	34	154	76	98	56	0.75	21				
ATUM 20XD4 SO.. 060304	●	20	25	34	158	80	102	56	0.65	21.3				
ATUM 21XD4 SO.. 070305	●	21	25	34	162	84	106	56	1.75	24.5	SO.. 070305	3008-M2.5x6	80-T08	
ATUM 22XD4 SO.. 070305	●	22	25	34	166	88	110	56	1.5	25				
ATUM 22.5XD4 SO.. 070305	●	22.5	25	34	166	88	110	56	1.35	25.2				
ATUM 23XD4 SO.. 070305	●	23	25	34	170	92	114	56	1.25	25.5				
ATUM 24XD4 SO.. 070305	●	24	25	34	174	96	118	56	1	26				
ATUM 25XD4 SO.. 09T306	●	25	25	34	178	100	122	56	2.25	29.5	SO.. 09T306	4010-M3x8	80-T10	
ATUM 27XD4 SO.. 09T306	●	27	25	34	186	108	130	56	1.75	30.5				
ATUM 28XD4 SO.. 09T306	●	28	25	34	190	112	134	56	1.5	31				
ATUM 29XD4 SO.. 09T306	●	29	25	34	194	116	138	56	1.25	31.5				
ATUM 30XD4 SO.. 09T306	●	30	32	44	207	120	147	60	1	32				
ATUM 31XD4 SO.. 09T306	●	31	32	44	211	124	151	60	0.75	32.5	SO.. 120408	4015-M4X11	80-T15	
ATUM 33XD4 SO.. 09T306	●	33	32	44	219	132	159	60	0.5	34				
ATUM 34XD4 SO.. 09T306	●	34	32	44	223	136	163	60	0.25	34.5				
ATUM 35XD4 SO.. 120408	●	35	32	44	227	140	167	60	2.75	40.5				

R: Sağ / Right / Правый L: Sol / Left / Левый

● Stokta / In Stock / В наличии ○ Stokta Yok / Non Stock Item / Нет в наличии
ISCR Ucuna Uygunudur. / Compatible with ISCR Insert. / Под пластину ISCR

Sipariş Örneği/Ordering Example/Образец заказа

1 ad./pcs./шт. ATUM 14XD4 SO.. 050204

Takma Uçlu Matkap Kullanım Kılavuzu : S 367 / User's Guide For U-Drills : P 367
Руководство для эксплуатации сверел: стр. 368



Delme Derinliği = 2x Çap
Drilling Depth = 2x Diameter
Глубина сверления = 2x Диаметр

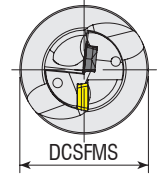
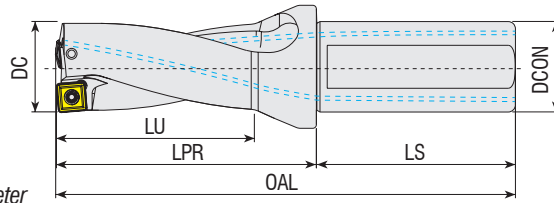

Takım Kodu
Ordering Code
Код для заказа

Stok Stock Наличие	Takım Ölçüleri (mm) Dimension (mm) Размеры (мм)								Maks. Ofset (radyal) Max. Offset (radial) Радиальное смещение		Kesici Uç Insert Пластина	Yedek Parçaları / Spare Parts / Запасные части	
	DC	DCON	DCSFMS	OAL	LU	LPR	LS	X _{max}	DC _{max}	Sıkma Vidası Screw Зажимной винт		Tork Anahtar Torx Key Торх Ключ	
ATUM 14XD2 KDR 0502..	14	20	25	100	28	50	50	0.25	14.5	SPMT 050204-XOMT 050204	3006-M2x4	80-T06	
ATUM 18XD2 KDR 0602..	18	25	34	114	36	58	56	0.5	19	SPMT 060205-XOMT 060204	3007-M2.2x5	80-T07	
ATUM 20XD2 KDR 07T2..	20	25	34	118	40	62	56	0.3	20.6	SPMT 07T208	3008-M2.5x6	80-T08	
ATUM 22XD2 KDR 07T2..	22	25	34	122	44	66	56	0.3	22.6	XOMT 07T205			
ATUM 24XD2 KDR 0903..	24	25	34	126	48	70	56	0.3	24.6				
ATUM 25XD2 KDR 0903..	25	25	34	128	50	72	56	0.3	25.6	SPMT 090308	3008-M3x7		
ATUM 26XD2 KDR 0903..	26	25	34	130	52	74	56	0.3	26.6	XOMT 090305			
ATUM 28XD2 KDR 0903..	28	25	34	134	56	78	56	0.3	28.6				
ATUM 30XD2 KDR 11T3..	30	25	34	147	60	87	60	0.35	30.7				
ATUM 32XD2 KDR 11T3..	32	32	44	151	64	91	60	0.35	32.7	SPMT 11T308	4015-M3.5x9	80-T15	
ATUM 34XD2 KDR 11T3..	34	32	44	155	68	95	60	0.35	34.7	XOMT 11T306			
ATUM 37XD2 KDR 1304..	37	32	44	161	74	101	60	0.35	37.7	SPMT 130410 - XOMT 130406	4015-M4x11		

KRLY Ucuna Uygun. / Compatible with KRLY Insert. / Под пластину KRYL



Delme Derinliği = 4x Çap
Drilling Depth = 4x Diameter
Глубина сверления = 4x Диаметр

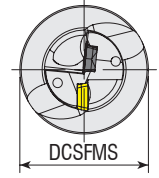
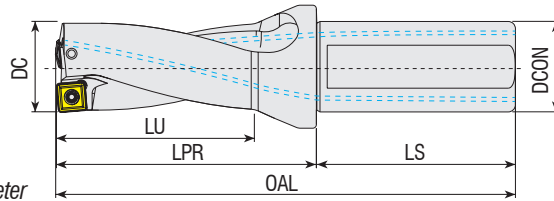

Takım Kodu
Ordering Code
Код для заказа

Stok Stock Наличие	Takım Ölçüleri (mm) Dimension (mm) Размеры (мм)								Maks. Ofset (radyal) Max. Offset (radial) Радиальное смещение		Kesici Uç Insert Пластина	Yedek Parçaları / Spare Parts / Запасные части	
	DC	DCON	DCSFMS	OAL	LU	LPR	LS	X _{max}	DC _{max}	Sıkma Vidası Screw Зажимной винт		Tork Anahtar Torx Key Торх Ключ	
ATUM 14XD4 KDR 0502..	14	20	25	128	56	78	50	0.25	14.5	SPMT 050204 XOMT 050204	3006-M2x4	80-T06	
ATUM 14.5XD4 KDR 0502..	14.5	20	25	128	56	78	50	0.25	15				
ATUM 15XD4 KDR 0502..	15	20	25	132	60	82	50	0.25	15.5				
ATUM 15.5XD4 KDR 0502..	15.5	20	25	132	60	82	50	0.25	16				
ATUM 16XD4 KDR 0502..	16	25	34	142	64	86	56	0.25	16.5	SPMT 060205 XOMT 060204	3007-M2.2x5	80-T07	
ATUM 17XD4 KDR 0602..	17	25	34	146	68	90	56	0.5	18				
ATUM 17.5XD4 KDR 0602..	17.5	25	34	146	68	90	56	0.5	18.5				
ATUM 18XD4 KDR 0602..	18	25	34	150	72	94	56	0.5	19				
ATUM 18.5XD4 KDR 0602..	18.5	25	34	150	72	94	56	0.5	19.5	SPMT 07T208 XOMT 07T205	3008-M2.5x6	80-T08	
ATUM 19XD4 KDR 0602..	19	25	34	154	76	98	56	0.5	20				
ATUM 20XD4 KDR 07T2..	20	25	34	158	80	102	56	0.3	20.6				
ATUM 21XD4 KDR 07T2..	21	25	34	162	84	106	56	0.3	21.6				
ATUM 22XD4 KDR 07T2..	22	25	34	166	88	110	56	0.3	22.6	SPMT 090308 XOMT 090305	3008-M3x7	80-T15	
ATUM 24XD4 KDR 0903..	24	25	34	174	96	118	56	0.3	24.6				
ATUM 25XD4 KDR 0903..	25	25	34	178	100	122	56	0.3	25.6				

R: Sağ / Right / Правый L: Sol / Left / Левый

● Stokta / In Stock / В наличии ○ Stokta Yok / Non Stock Item / Нет в наличии

KRLY Ucuna Uygun. / Compatible with KRLY Insert. / Под пластину KRYL

Sipariş Örneği/Ordering Example/Образец заказа

1 ad./pcs./шт. ATUM 14XD2 KDR 0502..

Takma Uçlu Matkap Kullanım Kılavuzu : S 367 / User's Guide For U-Drills : P 367 / Руководство для эксплуатации сверел: стр. 368



Delme Derinliği = 3x Çap
Drilling Depth = 3x Diameter
Глубина сверления = 3x Диаметр

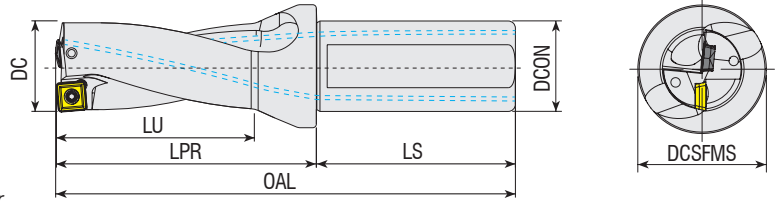

Takım Kodu Ordering Code Код для заказа	Stok Stock Наличие	Takım Ölçüleri (mm) Dimension (mm) Размеры (мм)								Maks. Offset (radyal) Max. Offset (radial) Радиальное смещение		Kesici Uç Insert Пластина	Yedek Parçaları / Spare Parts / Запасные части	
		DC	DCON	DCSFMS	OAL	LU	LPR	LS	X _{max} [mm]	DC _{max} [mm]	Sıkma Vidası Screw Зажимной винт		Tork Anahtar Torx Key Торх Ключ	
ATUM 12.5XD3 KDR 0402..	●	12.5	20	25	108	36	58	50	0.2	12.9	SPMT 040204 XOMT 040204	3006-M2x4	80-T06	
ATUM 13XD3 KDR 0402..	●	13	20	25	111	39	61	50	0.2	13.4				
ATUM 14XD3 KDR 0502..	●	14	20	25	114	42	64	50	0.25	14.5	SPMT 050204 XOMT 050204	3006-M2x4	80-T06	
ATUM 14.5XD3 KDR 0502..	●	14.5	20	25	114	42	64	50	0.25	15				
ATUM 15XD3 KDR 0502..	●	15	20	25	117	45	67	50	0.25	15.5	SPMT 060205 XOMT 060204	3007-M2.2x5	80-T07	
ATUM 15.5XD3 KDR 0502..	●	15.5	20	25	117	45	67	50	0.25	16				
ATUM 16XD3 KDR 0502..	●	16	25	34	126	48	70	56	0.25	16.5	SPMT 07T208 XOMT 07T205	3008-M2.5x6	80-T08	
ATUM 16.5XD3 KDR 0602..	●	16.5	25	34	126	48	70	56	0.5	17.5				
ATUM 17XD3 KDR 0602..	●	17	25	34	129	51	73	56	0.5	18	SPMT 090308 XOMT 090305	3008-M3x7	80-T15	
ATUM 17.5XD3 KDR 0602..	●	17.5	25	34	129	51	73	56	0.5	18.5				
ATUM 18XD3 KDR 0602..	●	18	25	34	132	54	76	56	0.5	19	SPMT 11T308 XOMT 11T306	4015-M3.5x9	80-T15	
ATUM 18.5XD3 KDR 0602..	●	18.5	25	34	132	54	76	56	0.5	19.5				
ATUM 19XD3 KDR 0602..	●	19	25	34	135	57	79	56	0.5	20	SPMT 130410 XOMT 130406	4015-M4x11	80-T15	
ATUM 19.5XD3 KDR 0602..	●	19.5	25	34	135	57	79	56	0.5	20.5				
ATUM 20XD3 KDR 07T2..	●	20	25	34	138	60	82	56	0.3	20.6	SPMT 11T308 XOMT 11T306	4015-M3.5x9	80-T15	
ATUM 20.5XD3 KDR 07T2..	●	20.5	25	34	138	60	82	56	0.3	21.1				
ATUM 21XD3 KDR 07T2..	●	21	25	34	141	63	85	56	0.3	21.6	SPMT 130410 XOMT 130406	4015-M4x11	80-T15	
ATUM 22XD3 KDR 07T2..	●	22	25	34	144	66	88	56	0.3	22.6				
ATUM 23XD3 KDR 07T2..	●	23	25	34	147	69	91	56	0.3	23.6	SPMT 130410 XOMT 130406	4015-M4x11	80-T15	
ATUM 23.5XD3 KDR 07T2..	●	23.5	25	34	147	69	91	56	0.3	24.1				
ATUM 24XD3 KDR 0903..	●	24	25	34	150	72	94	56	0.3	24.6	SPMT 130410 XOMT 130406	4015-M4x11	80-T15	
ATUM 24.5XD3 KDR 0903..	●	24.5	25	34	150	72	94	56	0.3	25.1				
ATUM 25XD3 KDR 0903..	●	25	25	34	153	75	97	56	0.3	25.6	SPMT 130410 XOMT 130406	4015-M4x11	80-T15	
ATUM 26XD3 KDR 0903..	●	26	25	34	156	78	100	56	0.3	26.6				
ATUM 27XD3 KDR 0903..	●	27	25	34	159	81	103	56	0.3	27.6	SPMT 130410 XOMT 130406	4015-M4x11	80-T15	
ATUM 28XD3 KDR 0903..	●	28	25	34	162	84	106	56	0.3	28.6				
ATUM 29XD3 KDR 0903..	●	29	25	34	165	87	109	56	0.3	29.6	SPMT 130410 XOMT 130406	4015-M4x11	80-T15	
ATUM 30XD3 KDR 11T3..	●	30	32	44	177	90	117	60	0.35	30.7				
ATUM 32XD3 KDR 11T3..	●	32	32	44	183	96	123	60	0.35	32.7	SPMT 130410 XOMT 130406	4015-M4x11	80-T15	
ATUM 33XD3 KDR 11T3..	●	33	32	44	186	99	126	60	0.35	33.7				
ATUM 34XD3 KDR 11T3..	●	34	32	44	189	102	129	60	0.35	34.7	SPMT 130410 XOMT 130406	4015-M4x11	80-T15	
ATUM 35XD3 KDR 11T3..	●	35	32	44	192	105	132	60	0.35	35.7				
ATUM 37XD3 KDR 1304..	●	37	32	44	198	111	138	60	0.35	37.7	SPMT 130410 XOMT 130406	4015-M4x11	80-T15	
ATUM 38XD3 KDR 1304..	●	38	32	44	201	114	141	60	0.35	38.7				
ATUM 39XD3 KDR 1304..	●	39	32	44	204	117	144	60	0.35	39.7	SPMT 130410 XOMT 130406	4015-M4x11	80-T15	
ATUM 40XD3 KDR 1304..	●	40	32	44	207	120	147	60	0.35	40.7				

R: Sağ / Right / Правый L: Sol / Left / Левый
● Stokta / In Stock / В наличии ○ Stokta Yok / Non Stock Item / Нет в наличии
KRLY Ucuna Uygunudur. / Compatiple with KRLY Insert. / Под пластину KRYL

Sipariş Örneği/Ordering Example/Образец заказа
1 ad./pcs./шт. ATUM 12.5XD3 KDR 0402..
Takma Uçlu Matkap Kullanım Kılavuzu : S 367 / User's Guide For U-Drills : P 367
Руководство для эксплуатации сверел: стр. 368



Delme Derinliği = 2x Çap
Drilling Depth = 2x Diameter
Глубина сверления = 2x Диаметр

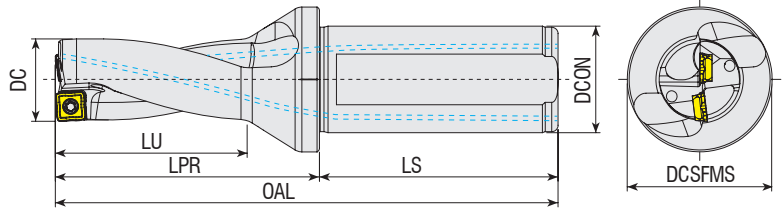

Takım Kodu
Ordering Code
Код для заказа

Stok
Stock
Наличие

Takım Ölçüleri (mm)
Dimension (mm)
Размеры (мм)

Maks. Ofset (radyal)
Max. Offset (radial)
Радиальное смещение

Kesici Uç
Insert
Пластина

Yedek Parçaları / Spare Parts / Запасные части

Sikma Vidası
Screw
Зажимной винт

Tork Anahtar
Torx Key
Торх Ключ

Takım Kodu Ordering Code Код для заказа	Stok Stock Наличие	Takım Ölçüleri (mm) Dimension (mm) Размеры (мм)							Maks. Ofset (radyal) Max. Offset (radial) Радиальное смещение		Kesici Uç Insert Пластина	Sikma Vidası Screw Зажимной винт	Tork Anahtar Torx Key Торх Ключ
		DC	DCON	DCSFMS	OAL	LU	LPR	LS	X _{max} X _{max} [mm]	DC _{max} DC _{max} [mm]			
ATUM 14XD2 SOMT 050204	●	14	20	25	100	28	50	50	0.5	15	SOMT 050204	3006-M2x4	80-T06
ATUM 16XD2 SOMT 050204	●	16	25	34	110	32	54	56	0.3	16.6			
ATUM 17XD2 SOMT 060204	●	17	25	34	112	34	56	56	0.5	18	SOMT 060204	3007-M2.2x5	80-T07
ATUM 18XD2 SOMT 060204	●	18	25	34	114	36	58	56	0.4	18.8			
ATUM 20XD2 SOMT 070306	●	20	25	34	118	40	62	56	0.5	21	SOMT 070306		
ATUM 22XD2 SOMT 070306	●	22	25	34	122	44	66	56	0.3	22.6			
ATUM 23XD2 SOMT 08T306	●	23	25	34	124	46	68	56	0.5	24	SOMT 08T306	3008-M2.5x6	80-T08
ATUM 24XD2 SOMT 08T306	●	24	25	34	126	48	70	56	0.5	25			
ATUM 25XD2 SOMT 08T306	●	25	25	34	128	50	72	56	0.4	25.8			
ATUM 26XD2 SOMT 08T306	●	26	25	34	130	52	74	56	0.3	26.6			
ATUM 27XD2 SOMT 09T308	●	27	25	34	132	54	76	56	0.5	28	SOMT 09T308		
ATUM 28XD2 SOMT 09T308	●	28	25	34	134	56	78	56	0.5	29			
ATUM 29XD2 SOMT 09T308	●	29	25	34	136	58	80	56	0.5	30			
ATUM 30XD2 SOMT 09T308	●	30	32	44	147	60	87	60	0.5	31			
ATUM 32XD2 SOMT 11T308	●	32	32	44	151	64	91	60	0.5	33	SOMT 11T308	4015-M3.5x9	80-T15
ATUM 33XD2 SOMT 11T308	●	33	32	44	153	66	93	60	0.5	34			
ATUM 34XD2 SOMT 11T308	●	34	32	44	155	68	95	60	0.5	35			
ATUM 35XD2 SOMT 11T308	●	35	32	44	157	70	97	60	0.5	36			
ATUM 37XD2 SOMT 130408	●	37	32	44	161	74	101	60	0.5	38	SOMT 130408	4015-M4x11	
ATUM 38XD2 SOMT 130408	●	38	32	44	163	76	103	60	0.5	39			
ATUM 40XD2 SOMT 130408	●	40	32	44	167	80	107	60	0.5	41			
ATUM 45XD2 SOMT 150510	●	45	40	54	192	90	122	70	0.5	46			
ATUM 47XD2 SOMT 150510	●	47	40	54	196	94	126	70	0.5	48	SOMT 150510	1020-M5x11	80-T20

R: Sağ / Right / Правый L: Sol / Left / Левый

● Stokta / In Stock / В наличии ○ Stokta Yok / Non Stock Item / Нет в наличии
TGTC Ucuna Uygunudur. / Compatiple with TGTC Insert. / Под пластину TGTC.

Sipariş Örneği/Ordering Example/Образец заказа

1 ad./pcs./шт. ATUM 14XD2 SOMT 050204

Takma Uçlu Matkap Kullanım Kılavuzu : S 367 / User's Guide For U-Drills : P 367

Руководство для эксплуатации сверел: стр. 368



Delme Derinliği = 3x Çap
Drilling Depth = 3x Diameter
Глубина сверления = 3x Диаметр

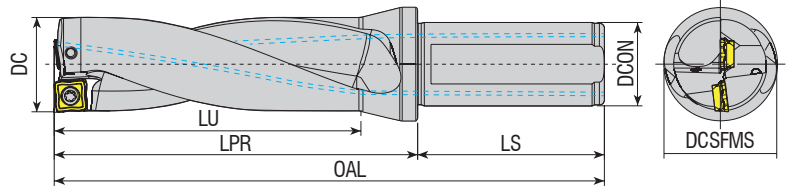

Takım Kodu
Ordering Code
Код для заказа

Takım Kodu Ordering Code Код для заказа	Stok Stock Наличие	Takım Ölçüleri (mm) Dimension (mm) Размеры (мм)							Maks. Ofset (radyal) Max. Offset (radial) Радиальное смещение		Kesici Uç Insert Пластина	Yedek Parçaları / Spare Parts / Запасные части		
		DC	DCON	DCSFMS	OAL	LU	LPR	LS	X _{max} X _{max} [mm]	DC _{max} DC _{max} [mm]		Sıkma Vidası Screw Зажимной винт	Tork Anahtar Torx Key Торк Ключ	
ATUM 14XD3 SOMT 050204	●	14	20	25	114	42	64	50	0.5	15	SOMT 050204	3006-M2x4	80-T06	
ATUM 14.5XD3 SOMT 050204	●	14.5	20	25	114	42	64	50	0.4	15.3				
ATUM 15XD3 SOMT 050204	●	15	20	25	117	45	67	50	0.4	15.8				
ATUM 15.5XD3 SOMT 050204	●	15.5	20	25	117	45	67	50	0.3	16.1				
ATUM 16XD3 SOMT 050204	●	16	25	34	126	48	70	56	0.3	16.6	SOMT 060204	3007-M2.2x5	80-T07	
ATUM 16.5XD3 SOMT 060204	●	16.5	25	34	126	48	70	56	0.5	17.5				
ATUM 17XD3 SOMT 060204	●	17	25	34	129	51	73	56	0.5	18				
ATUM 17.5XD3 SOMT 060204	●	17.5	25	34	129	51	73	56	0.4	18.3				
ATUM 18XD3 SOMT 060204	●	18	25	34	132	54	76	56	0.4	18.8	SOMT 070306	3008-M2.5x6	80-T08	
ATUM 18.5XD3 SOMT 060204	●	18.5	25	34	132	54	76	56	0.3	19.1				
ATUM 19XD3 SOMT 060204	●	19	25	34	135	57	79	56	0.3	19.6				
ATUM 19.5XD3 SOMT 070306	●	19.5	25	34	135	57	79	56	0.5	20.5				
ATUM 20XD3 SOMT 070306	●	20	25	34	138	60	82	56	0.5	21	SOMT 08T306	4015-M3.5x9	80-T15	
ATUM 20.5XD3 SOMT 070306	●	20.5	25	34	138	60	82	56	0.4	21.3				
ATUM 21XD3 SOMT 070306	●	21	25	34	141	63	85	56	0.4	21.8				
ATUM 22XD3 SOMT 070306	●	22	25	34	144	66	88	56	0.3	22.6				
ATUM 22.5XD3 SOMT 08T306	●	22.5	25	34	144	66	88	56	0.5	23.5	SOMT 09T308	4015-M4x11	80-T20	
ATUM 23XD3 SOMT 08T306	●	23	25	34	147	69	91	56	0.5	24				
ATUM 23.5XD3 SOMT 08T306	●	23.5	25	34	147	69	91	56	0.5	24.5				
ATUM 24XD3 SOMT 08T306	●	24	25	34	150	72	94	56	0.5	25				
ATUM 24.5XD3 SOMT 08T306	●	24.5	25	34	150	72	94	56	0.4	25.3	SOMT 11T308	1020-M5x11	80-T20	
ATUM 25XD3 SOMT 08T306	●	25	25	34	153	75	97	56	0.4	25.8				
ATUM 26XD3 SOMT 08T306	●	26	25	34	156	78	100	56	0.3	26.6				
ATUM 27XD3 SOMT 09T308	●	27	25	34	159	81	103	56	0.5	28				
ATUM 27.5XD3 SOMT 09T308	●	27.5	25	34	159	81	103	56	0.5	27.5	SOMT 130408	1020-M5x11	80-T20	
ATUM 28XD3 SOMT 09T308	●	28	25	34	162	84	106	56	0.5	29				
ATUM 29XD3 SOMT 09T308	●	29	25	34	165	87	109	56	0.5	30				
ATUM 30XD3 SOMT 09T308	●	30	32	44	177	90	117	60	0.5	31				
ATUM 32XD3 SOMT 11T308	●	32	32	44	183	96	123	60	0.5	33	SOMT 150510	1020-M5x11	80-T20	
ATUM 33XD3 SOMT 11T308	●	33	32	44	186	99	126	60	0.5	34				
ATUM 34XD3 SOMT 11T308	●	34	32	44	189	102	129	60	0.5	35				
ATUM 35XD3 SOMT 11T308	●	35	32	44	192	105	132	60	0.5	36				
ATUM 36XD3 SOMT 11T308	●	36	32	44	195	108	135	60	0.4	36.8	SOMT 150510	1020-M5x11	80-T20	
ATUM 37XD3 SOMT 130408	●	37	32	44	198	111	138	60	0.5	38				
ATUM 38XD3 SOMT 130408	●	38	32	44	201	114	141	60	0.5	39				
ATUM 39XD3 SOMT 130408	●	39	32	44	204	117	144	60	0.5	40				
ATUM 40XD3 SOMT 130408	●	40	32	44	207	120	147	60	0.5	41	SOMT 150510	1020-M5x11	80-T20	
ATUM 45XD3 SOMT 150510	●	45	40	54	237	135	167	70	0.5	46				
ATUM 49XD3 SOMT 150510	●	49	40	54	249	147	179	70	0.5	50				
ATUM 50XD3 SOMT 150510	●	50	40	54	252	150	182	70	0.5	51				

R: Sağ / Right / Правый L: Sol / Left / Левый

● Stokta / In Stock / В наличии ○ Stokta Yok / Non Stock Item / Нет в наличии

TGTC Ucuna Uygunudur. / Compatiple with TGTC Insert. / Под пластину TGTC.

Sipariş Örneği/Ordering Example/Образец заказа

1 ad./pcs./шт. ATUM 14XD3 SOMT 050204

Takma Uçlu Matkap Kullanım Kılavuzu : S 367 / User's Guide For U-Drills : P 367

Руководство для эксплуатации сверел: стр. 368



Delme Derinliği = 4x Çap
Drilling Depth = 4x Diameter
Глубина сверления = 4x Диаметр

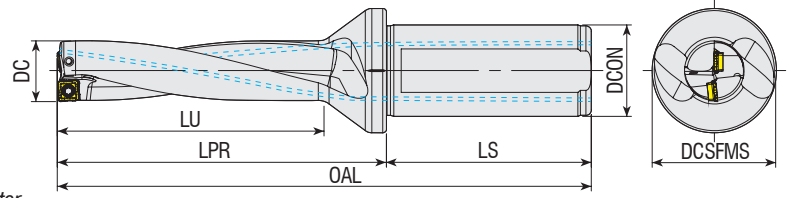

Takım Kodu
Ordering Code
Код для заказа

Takım Kodu Ordering Code Код для заказа	Stok Stock Наличие	Takım Ölçüleri (mm) Dimension (mm) Размеры (мм)							Maks. Ofset (radyal) Max. Offset (radial) Радиальное смещение		Kesici Uç Insert Пластина	Yedek Parçaları / Spare Parts / Запасные части	
		DC	DCON	DCSFMS	OAL	LU	LPR	LS	X _{max} X _{max} [mm]	DC _{max} DC _{max} [mm]		Sıkma Vidası Screw Зажимной винт	Tork Anahtar Torx Key Торх Ключ
ATUM 14XD4 SOMT 050204	●	14	20	25	128	56	78	50	0.5	15	SOMT 050204	3006-M2x4	80-T06
ATUM 14.5XD4 SOMT 050204	●	14.5	20	25	128	56	78	50	0.4	15.3			
ATUM 16XD4 SOMT 050204	●	16	25	34	142	64	86	56	0.3	16.6	SOMT 060204	3007-M2.2x5	80-T07
ATUM 17XD4 SOMT 060204	●	17	25	34	146	68	90	56	0.5	18			
ATUM 17.5XD4 SOMT 060204	●	17.5	25	34	146	68	90	56	0.4	18.3	SOMT 060204	3007-M2.2x5	80-T07
ATUM 18XD4 SOMT 060204	●	18	25	34	150	72	94	56	0.4	18.8			
ATUM 19XD4 SOMT 060204	●	19	25	34	154	76	98	56	0.3	19.6	SOMT 070306	3008-M2.5x6	80-T08
ATUM 20XD4 SOMT 070306	●	20	25	34	158	80	102	56	0.5	21			
ATUM 21XD4 SOMT 070306	●	21	25	34	162	84	106	56	0.4	21.8	SOMT 070306	3008-M2.5x6	80-T08
ATUM 22XD4 SOMT 070306	●	22	25	34	166	88	110	56	0.3	22.6			
ATUM 24XD4 SOMT 08T306	●	24	25	34	174	96	118	56	0.5	25	SOMT 08T306	3008-M2.5x6	80-T08
ATUM 25XD4 SOMT 08T306	●	25	25	34	178	100	122	56	0.4	25.8			

R: Sağ / Right / Правый L: Sol / Left / Левый
● Stokta / In Stock / В наличии ○ Stokta Yok / Non Stock Item / Нет в наличии
TGTC Ucuna Uygundur. / Compatible with TGTC Insert. / Под пластину TGTC.

Sipariş Örneği/Ordering Example/Образец заказа
1 ad./pcs./шт. ATUM ATUM 14XD4 SOMT 050204
Takma Uçlu Matkap Kullanım Kılavuzu : S 367 / User's Guide For U-Drills : P 367
Руководство для эксплуатации сверел: стр. 368





Delme Derinliği = 5x Çap
Drilling Depth = 5x Diameter
Глубина сверления = 5x Диаметр

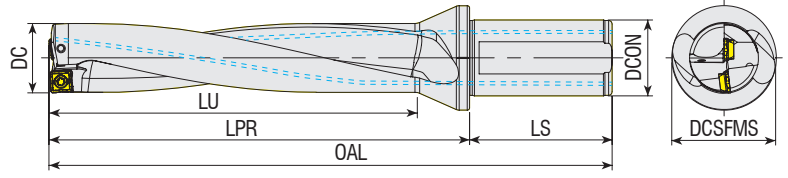

Takım Kodu Ordering Code Код для заказа	Stok Stock Наличие	Takım Ölçüleri (mm) Dimension (mm) Размеры (мм)							Maks. Offset (radyal) Max. Offset (radial) Радиальное смещение		Kesici Uç Insert Пластина	Yedek Parçaları / Spare Parts / Запасные части	
		DC	DCON	DCSFMS	OAL	LU	LPR	LS	X _{max} [mm]	DC _{max} [mm]		Sıkma Vidası Screw Зажимной винт	Tork Anahtar Torx Key Торх Ключ
ATUM 14XD5 SOMT 050204	●	14	20	25	142	70	92	50	0.5	15	SOMT 050204	3006-M2x4	80-T06
ATUM 15XD5 SOMT 050204	●	15	20	25	147	75	97	50	0.4	15.8			
ATUM 15.5XD5 SOMT 050204	●	15.5	20	25	147	75	97	50	0.3	16.1			
ATUM 16XD5 SOMT 050204	●	16	25	34	158	80	102	56	0.3	16.6	SOMT 060204	3007-M2.2x5	80-T07
ATUM 16.5XD5 SOMT 060204	●	16.5	25	34	158	80	102	56	0.5	17.5			
ATUM 17.5XD5 SOMT 060204	●	17.5	25	34	163	85	107	56	0.4	18.3			
ATUM 18XD5 SOMT 060204	●	18	25	34	168	90	112	56	0.4	18.8	SOMT 070306	3008-M2.5x6	80-T08
ATUM 18.5XD5 SOMT 060204	●	18.5	25	34	168	90	112	56	0.3	19.1			
ATUM 19XD5 SOMT 060204	●	19	25	34	173	95	117	56	0.3	19.6			
ATUM 19.5XD5 SOMT 070306	●	19.5	25	34	173	95	117	56	0.5	20.5	SOMT 08T306	4015-M3.5x9	80-T15
ATUM 20XD5 SOMT 070306	●	20	25	34	178	100	122	56	0.5	21			
ATUM 21XD5 SOMT 070306	●	21	25	34	183	105	127	56	0.4	21.8			
ATUM 22XD5 SOMT 070306	●	22	25	34	188	110	132	56	0.3	22.6	SOMT 09T308	4015-M3.5x9	80-T15
ATUM 23XD5 SOMT 08T306	●	23	25	34	193	115	137	56	0.5	24			
ATUM 24XD5 SOMT 08T306	●	24	25	34	198	120	142	56	0.5	25			
ATUM 25XD5 SOMT 08T306	●	25	25	34	203	125	147	56	0.4	25.8	SOMT 11T308	4015-M3.5x9	80-T15
ATUM 26XD5 SOMT 08T306	●	26	25	34	208	130	152	56	0.3	26.6			
ATUM 27XD5 SOMT 09T308	●	27	25	34	213	135	157	56	0.5	28			
ATUM 28XD5 SOMT 09T308	●	28	25	34	218	140	162	56	0.5	29	SOMT 11T308	4015-M3.5x9	80-T15
ATUM 29XD5 SOMT 09T308	●	29	25	34	223	145	167	56	0.5	30			
ATUM 30XD5 SOMT 09T308	●	30	32	44	237	150	177	60	0.5	31			
ATUM 33XD5 SOMT 11T308	●	33	32	44	252	165	192	60	0.5	34	SOMT 11T308	4015-M3.5x9	80-T15
ATUM 34XD5 SOMT 11T308	●	34	32	44	257	170	197	60	0.5	35			
ATUM 35XD5 SOMT 11T308	●	35	32	44	262	175	202	60	0.5	36			
ATUM 36XD5 SOMT 11T308	●	36	32	44	267	180	207	60	0.4	36.8			

R: Sağ / Right / Правый L: Sol / Left / Левый

● Stokta / In Stock / В наличии ○ Stokta Yok / Non Stock Item / Нет в наличии

TGTC Ucuna Uygun / Compatible with TGTC Insert. / Под пластину TGTC.

Sipariş Örneği/Ordering Example/Образец заказа

1 ad./pcs./шт. ATUM 14XD5 SOMT 050204

Takma Uçlu Matkap Kullanım Kılavuzu : S 367 / User's Guide For U-Drills : P 367

Руководство для эксплуатации сверел: стр. 368



Delme Derinliği = 3x Çap
Drilling Depth = 3x Diameter
Глубина сверления = 3x Диаметр

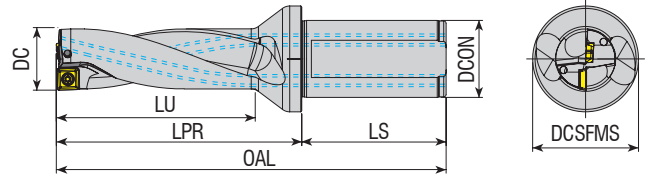

Takım Kodu
Ordering Code
Код для заказа

Stok
Stock
Наличие

Takım Ölçüleri (mm)
Dimension (mm)
Размеры (мм)

Maks. Ofset (radyal)
Max. Offset (radial)
Радиальное смещение

Kesici Uç
Insert
Пластина

Yedek Parçaları / Spare Parts / Залпасные части

Sıkma Vidası
Screw
Зажимной винт

Tork Anahtar
Torx Key
Торх Ключ

Takım Kodu Ordering Code Код для заказа	Stok Stock Наличие	DC	DCON	DCSFMS	OAL	LU	LPR	LS	Maks. Ofset (radyal) Max. Offset (radial) Радиальное смещение		Kesici Uç Insert Пластина	Sıkma Vidası Screw Зажимной винт	Tork Anahtar Torx Key Торх Ключ
									X _{max}	DC _{max} [mm]			
ATUM 14XD3 880-0202..	●	14	20	25	108	42	58	50	0.5	15	880-02...C/P	3006-M2x4	80-T06
ATUM 14.5XD3 880-0202..	●	14.5	20	25	110	46	60	50	0.45	15.4			
ATUM 15XD3 880-0202..	●	15	20	25	112	48	62	50	0.4	15.8			
ATUM 15.5XD3 880-0202..	●	15.5	20	25	114	50	64	50	0.3	16.1			
ATUM 16XD3 880-0202..	●	16	20	25	116	51	66	50	0.3	16.6			
ATUM 16.5XD3 880-0303..	●	16.5	20	25	118	53	68	50	0.6	17.7	880-03...C/P	3007-M2.2x5	80-T07
ATUM 17XD3 880-0303..	●	17	20	25	119	54	69	50	0.6	18.2			
ATUM 17.5XD3 880-0303..	●	17.5	25	32	128	56	72	56	0.5	18.5			
ATUM 18XD3 880-0303..	●	18	25	32	129	57	73	56	0.4	18.8			
ATUM 18.5XD3 880-0303..	●	18.5	25	32	131	59	75	56	0.4	19.3			
ATUM 19XD3 880-0303..	●	19	25	32	132	60	76	56	0.3	19.6			
ATUM 19.5XD3 880-0303..	●	19.5	25	32	135	62	79	56	0.3	20.1			
ATUM 20XD3 880-0403..	●	20	25	32	137	64	81	56	0.9	21.8	880-04...C/P	3008-M2.5x6	80-T08
ATUM 20.5XD3 880-0403..	●	20.5	25	32	138	65	82	56	0.8	22.1			
ATUM 21XD3 880-0403..	●	21	25	32	140	66	84	56	0.8	22.6			
ATUM 21.5XD3 880-0403..	●	21.5	25	32	142	68	86	56	0.7	22.9			
ATUM 22XD3 880-0403..	●	22	25	32	143	69	87	56	0.6	23.2			
ATUM 22.5XD3 880-0403..	●	22.5	25	32	146	71	90	56	0.5	23.5			
ATUM 23XD3 880-0403..	●	23	25	32	147	72	91	56	0.5	24			
ATUM 24XD3 880-0503..	●	24	25	32	151	76	95	56	1.1	26.2			
ATUM 25XD3 880-0503..	●	25	25	32	155	79	99	56	1	27			
ATUM 26XD3 880-0503..	●	26	32	44	162	81	102	60	0.9	27.8			
ATUM 27XD3 880-0503..	●	27	32	44	165	84	105	60	0.7	28.4			
ATUM 28XD3 880-0503..	●	28	32	44	169	87	109	60	0.6	29.2			
ATUM 29XD3 880-0503..	●	29	32	44	172	90	112	60	0.5	30			
ATUM 30XD3 880-0604..	●	30	32	44	177	94	117	60	1.1	32.2	880-06...C/P	3010-M3.5x9	80-T10
ATUM 31XD3 880-0604..	●	31	40	54	191	97	121	70	1	33			
ATUM 32XD3 880-0604..	●	32	40	54	194	100	124	70	0.9	33.8			
ATUM 33XD3 880-0604..	●	33	40	54	198	103	128	70	0.7	34.4			
ATUM 34XD3 880-0604..	●	34	40	54	201	106	131	70	0.5	35			
ATUM 35XD3 880-0604..	●	35	40	54	205	109	135	70	0.4	35.8			
ATUM 36XD3 880-0704..	●	36	40	54	209	112	139	70	1.3	38.6			
ATUM 38XD3 880-0704..	●	38	40	54	216	118	146	70	1.1	40.2			
ATUM 39XD3 880-0704..	●	39	40	54	219	121	149	70	1	41			
ATUM 40XD3 880-0704..	●	40	40	54	223	124	153	70	0.8	41.6			
ATUM 41XD3 880-0704..	●	41	40	54	227	127	157	70	0.7	42.4			
ATUM 42XD3 880-0704..	●	42	40	54	230	130	160	70	0.6	43.2			
ATUM 45XD3 880-0805..	●	45	40	54	242	140	172	70	1.4	47.8	880-08...C/P	4015-M4x11	80-T15
ATUM 46XD3 880-0805..	●	46	40	54	246	143	176	70	1.3	48.6			
ATUM 48XD3 880-0805..	●	48	40	54	253	149	183	70	1	50			
ATUM 50XD3 880-0805..	●	50	40	54	260	155	190	70	0.8	51.6			

R: Sağ / Right / Правый L: Sol / Left / Левый

● Stokta / In Stock / В наличии ○ Stokta Yok / Non Stock Item / Нет в наличии

SNDVK Ucuna Uygunudur. / Compatiple with SNDVK Insert. / Под пластину SNDVK

Sipariş Örneği/Ordering Example/Образец заказа

1 ad./pcs./шт. ATUM 14XD3 880-0202..

Takma Uçlu Matkap Kullanım Kılavuzu : S 367 / User's Guide For U-Drills : P 367

Руководство для эксплуатации сверел: стр. 368

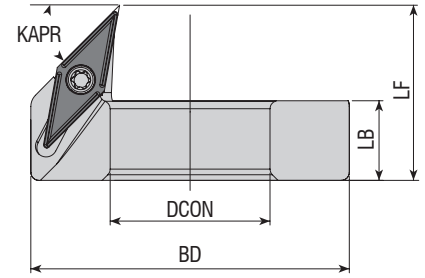

Takım Kodu Ordering Code Код для заказа	Stok Stock Наличие	Takım Ölçüleri (mm) Dimension (mm) Размеры (мм)				Kullanılacak ATUM Ölçüsü Compatible ATUM Diameter Verwendeter Vellochwert	Yedek Parçaları / Spare Parts / Запасные части				
		BD	DCON	LB	LF		Kesici Uç Insert Пластина	Sıkma Vidası Screw Зажимной винт	Tork Anahtar Torx Key Торх Ключ	Montaj Vidası Mounting Screw Монтажный винт	Montaj Vida Anahtar Mounting Screw Key Ключевый винт с торцевой частью
ADCR-120-VB1103	●	32	12	10	22	12.5	VB.T 1103..	4008-M2.5x6	80-T08	AAV-14-M5x14	AAL-03-3
ADCR-125-VB1103	●	32.5	12.5	10	22	13					
ADCR-130-VB1103	●	33	13	10	22	13.5					
ADCR-135-VB1103	●	33.5	13.5	10	22	14					
ADCR-140-VB1103	●	34	14	10	22	14.5					
ADCR-145-VB1103	●	34.5	14.5	10	22	15					
ADCR-150-VB1103	●	35	15	10	22	15.5 -16					
ADCR-155-VB1103	●	35.5	15.5	10	22	16.5					
ADCR-160-VB1103	●	36	16	10	22	17					
ADCR-165-VB1103	●	36.5	16.5	10	22	17.5					
ADCR-170-VB1103	●	37	17	10	22	18					
ADCR-175-VB1103	●	37.5	17.5	10	22	18.5					
ADCR-180-VB1103	●	38	18	10	22	19					
ADCR-185-VB1103	●	38.5	18.5	10	22	19.5					
ADCR-190-VB1103	●	39	19	10	22	20					
ADCR-195-VB1103	●	39.5	19.5	10	22	20.5					
ADCR-200-VB1103	●	40	20	10	22	21					
ADCR-205-VB1103	●	40.5	20.5	10	22	21.5					
ADCR-210-VB1103	●	41	21	10	22	22					
ADCR-215-VB1103	●	41.5	21.5	10	22	22.5					
ADCR-220-VB1103	●	42	22	10	22	23					
ADCR-225-VB1103	●	42.5	22.5	10	22	23.5					
ADCR-230-VB1103	●	43	23	10	22	24					
ADCR-235-VB1103	●	43.5	23.5	10	22	24.5					
ADCR-240-VB1103	●	44	24	10	22	25					
ADCR-245-VB1103	●	44.5	24.5	10	22	25.5					
ADCR-250-VB1103	●	45	25	10	22	26					
ADCR-255-VB1103	●	45.5	25.5	10	22	26.5					
ADCR-260-VB1103	●	46	26	10	22	27					
ADCR-265-VB1103	●	46.5	26.5	10	22	27.5					
ADCR-270-VB1103	●	47	27	10	22	28					
ADCR-275-VB1103	●	47.5	27.5	10	22	28.5					
ADCR-280-VB1103	●	48	28	10	22	29					
ADCR-285-VB1103	●	48.5	28.5	10	22	29.5					
ADCR-290-VB1103	●	49	29	10	22	30					
ADCR-295-VB1103	●	49.5	29.5	10	22	30.5					
ADCR-300-VB1103	●	50	30	10	22	31					

R: Sağ / Right / Правый L: Sol / Left / Левый

● Stokta / In Stock / В наличии ○ Stokta Yok / Non Stock Item / Нет в наличии

ISO Ucuna Uygunudur. / Compatible with ISO Insert. / Под пластину ISO.

Sipariş Örneği/Ordering Example/Образец заказа

1 ad./pcs./шт. ADCR-120-VB1103

Takma Uçlu Matkap Kullanım Kılavuzu : S 367 / User's Guide For U-Drills : P 367

Руководство для эксплуатации сверел: стр. 368



Tavsiye Edilen / Recommended / Рекомендации

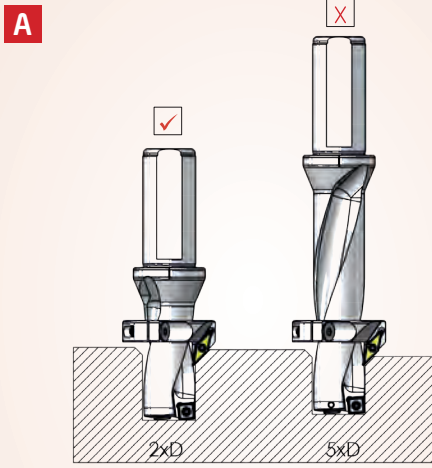

Mümkünse, her zaman kısa bir delme takımı kullanın. Değilse, titreşimi en az indirmek için kesme hızını azaltın.
If possible, use it always short drilling tools. Otherwise, reduce your speeds to minimize vibration.
По возможности используйте на коротких сверлах. В противном случае, уменьшите скорость вращения, чтобы минимизировать вибрацию

Montaj Şekli / Mounting System / Система установки

1



Matkap gövdesi üzerine pah kirma halkasını takın.
Put the chamfering ring to drill body.
Наденьте кольцо на сверло

2

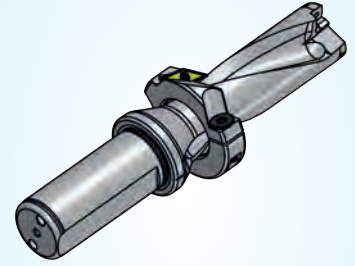

İstenilen konuma pah kirma halkasını kaydırın.
Please slide chamfering ring to the desired position.
Установите кольцо в нужном положении

B

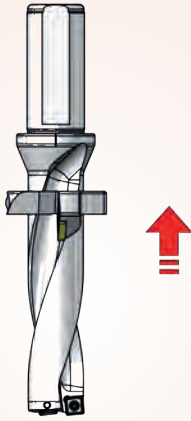

Mümkün olduğunca pah kirma halkasını shaft kısmına yakın montaj yap.
Get close to the mounting shaft of the chamfering ring as possible.
Установите фасочное кольцо как можно ближе к хвостовику

3

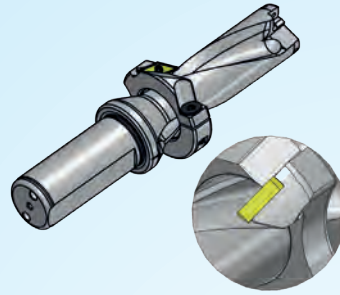

Pah kirma halkasını talaş akışına mani olmayacak şekilde helis başlangıcına denk getirin.
Please keep chamfering ring position which will not resist to fluiding chips and try to be equal to the helix start points.
Пожалуйста, зафиксируйте кольцо в таком положении, чтобы оно не препятствовало отводу стружки и было соосно начальным точкам спирали сверла.

4

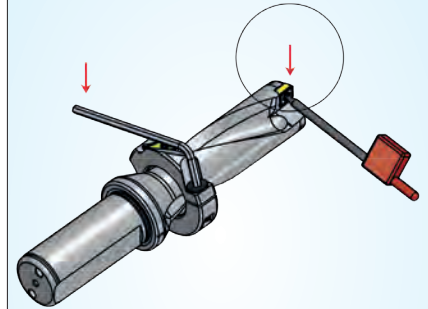

Pah kirma halkasını sıkın ve matkabin uçlarını takın.
Tightening the chamfering ring and put the drill insert.
Затяните фасочное кольцо и вставьте пластины в сверло

C

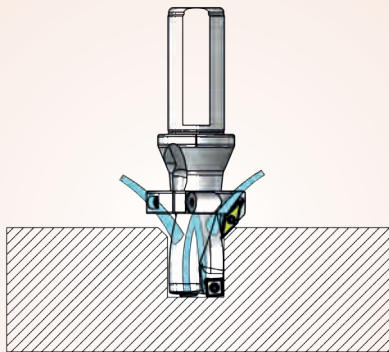

Daha iyi uç ömrü için harici soğutucu ve matkap ucu iç soğutucu uygulamak.
Apply external cooling and internal coolant drill for a better life for inserts.
Применяйте наружную и внутреннюю подачу СОЖ для продления срока службы пластин.

Pah kirma halkasının doğru montaj şekli.
Proper installation of chamfering rings.
Правильная установка колец для снятия фаски.

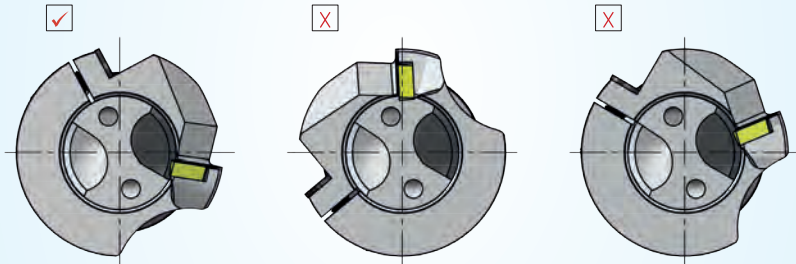

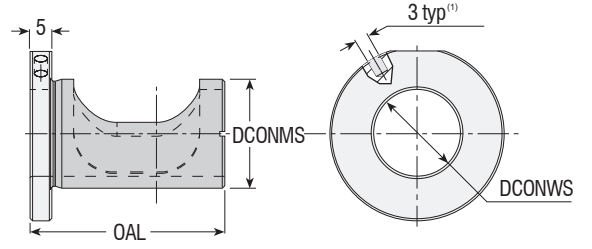

Takım Kodu
Ordering Code
Код для заказа

Stok
 Stock
 Наличие

Takım Ölçüleri (mm)
 Dimension (mm)
 Размеры (мм)

Takım Kodu / Ordering Code / Код для заказа	Stok / Stock / Наличие	DCON	BD	LF
AET-2025	●	20	25	44
AET-2532	●	25	32	46
AET-3240	●	32	40	55

■⁽¹⁾ Delik ince bir metal yardımıyla adaptörün radyal olarak ayarlanmasını kolaylaştırmak için kullanılır. / Holes for inserting a pin, used to facilitate radial adjustment of the sleeve (pin not supplied).
 Bohrung zum Einsetzen eines Stiftes mit dem der Adapter radial eingestellt werden kann (Stift ist nicht im Lieferumfang enthalten).

Frezeleme tezgahında takma uçlu matkabın nominal çapı, matkabın ekseninin, spindle eksenine göre ötelenmesiyle değiştirilebilir.
 On a milling machine the drill's nominal diameter can be changed by shifting the drill's axis out of the tool spindle.

На фрезерном станке номинальный диаметр сверла можно изменить, сместив ось сверла относительно оси шпинделя.

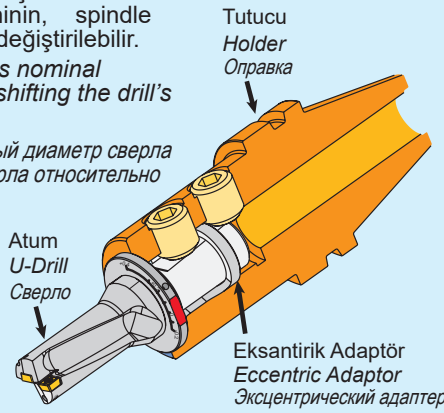

Radyal ayarlama pimi.
 (Verilmeyecektir.)

Radial adjustment pin.
 (not supplied)

Штифт для радиальной регулировки
 (в комплект не входит)

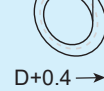
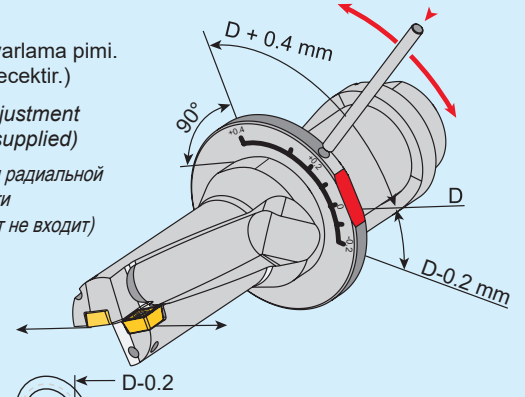

Eksantrik Adaptörü Kullanırken (AET)
 Tavsiye Edilen İlerleme Hızı
 Recommended Feed When Using Eccentric Adaptor
 Рекомендуемая скорость подачи при использовании эксцентрического адаптера

Tavsiye Edilen İlerleme Hızı / Recommended Feed Rate / Рекомендуемая скорость подачи

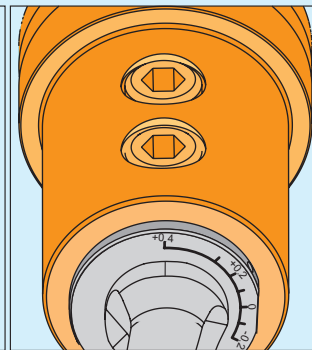
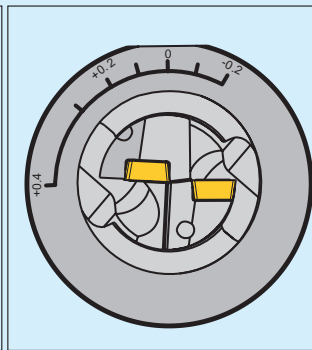
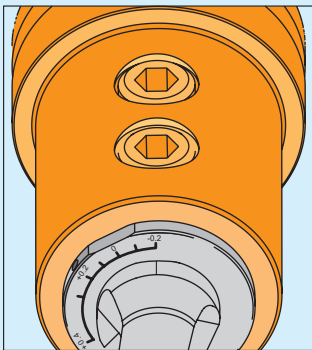
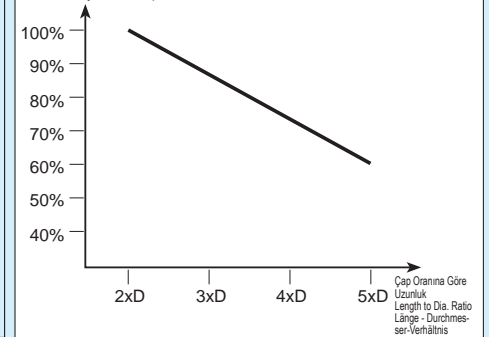

Delik Çapı
 24.8 mm
 Hole Diameter
 Диаметр отверстия

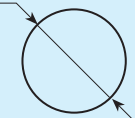

U-Drill Çapı = 25 mm
 Drill Diameter = 25 mm
 Диаметр сверла = 25 mm

Delik Çapı
 25 mm
 Hole Diameter
 Диаметр отверстия

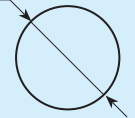

U-Drill Çapı = 25 mm
 Drill Diameter = 25 mm
 Диаметр сверла = 25 mm

Delik Çapı
 25.4 mm
 Hole Diameter
 Диаметр отверстия

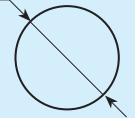

U-Drill Çapı = 25 mm
 Drill Diameter = 25 mm
 Диаметр сверла = 25 mm

ATUM'un üzerindeki düz çizgi adaptörün sıfır rakamının üzerine konulmalıdır. AET'nin (eksantrik adaptörün) çevrilmesini kolaylaştırmak için AET'nin üzerindeki deliğe, metal bir çubuk ya da vida anahtarını yerleştirilebilir. AET'yi ayarlamadan önce tutucunun vidasını hafifçe çözün.

The adjustment markings should be located perpendicular to the flat on the circumference of the U-DRILL flange.

To facilitate the rotation of the adaptor, a metal rod or a screw key may be inserted into a hole on the excentric adaptor flange. Unlock adaptor screw before adjusting adaptor.

Регулировочные метки должны быть расположены перпендикулярно к прямой по окружности фланца сверла.

Чтобы облегчить вращение адаптера металлический шток или ключ необходимо вставить в отверстие во фланец эксцентрического адаптера.

Отпустите винт адаптера перед его настройкой.

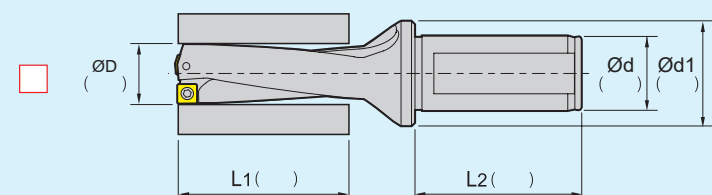
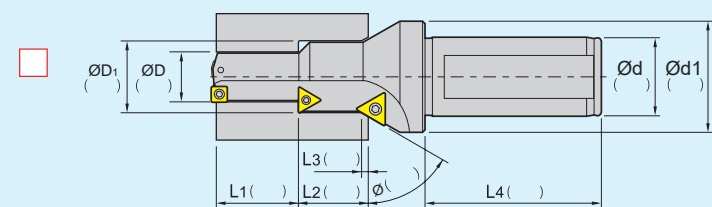
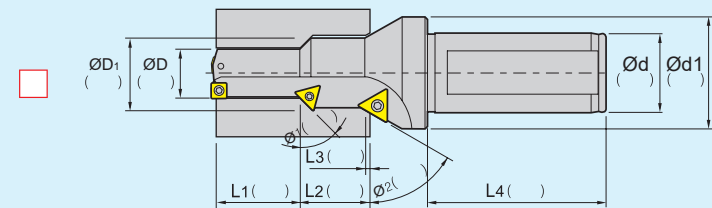
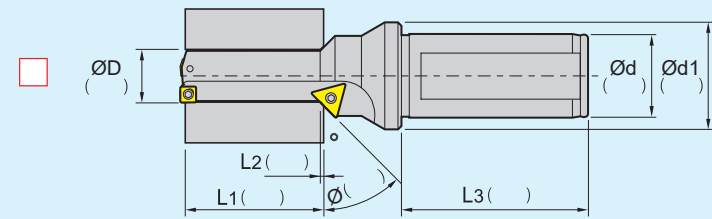
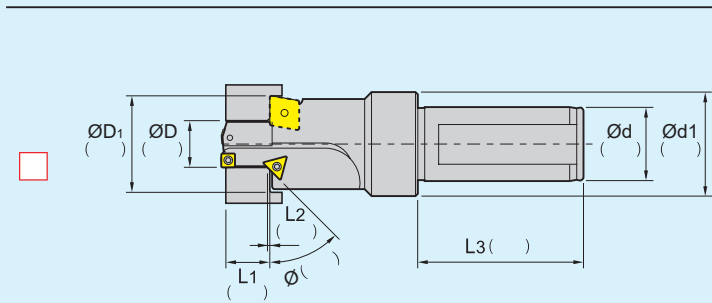

• Soğutma Tipi / Coolant type / Тип охлаждения

Yağ Deliği Dalma Kismında
Oil Hole On the Plunge Part
Боковая подача СОЖ

Yağ Deliği Şaft Kismında
"Oil hole On the Shank"
Подача СОЖ через хвостовик

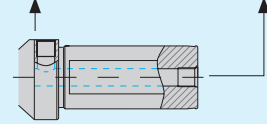

• Delik Tipi / Hole Type / Тип отверстия

Kapalı Delik
Blind Hole
Глухое отверстие

Açık Delik
Thru Hole
Сквозное отверстие

• Şaft Tipleri / Types of Shank / Типы хвостовика

Düz Tip
Flat Type
Цилиндрический хвостовик

Weldon Tip
Weldon Type
Хвостовик "Weldon"

Eğimli Yargı Tipi
Whistle Notch Type
Хвостовик с лыской

• Yargı Bağlama Yeri / Location of Side Lock / Расположение лыски хвостовика

Dış Uca Parelel (Standart)
Parallel to Peripheral Insert (Standard)
Стандартное - параллельно гнезду с внешней стороны пластины

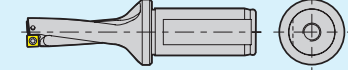

Dış Uca 90° Açılı
90° angle to peripheral insert
Угол 90° к периферийной вставке

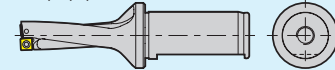

Dış Uca 150° Açılı
150° angle to peripheral insert
Угол 150° к периферийной вставке

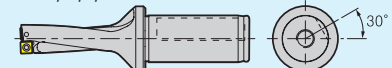

Dış Uca 180° Açılı
180° angle to peripheral insert
Угол 180° к периферийной вставке

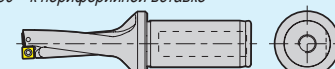

• Not / Note / Примечание :

- Şu Anki Kullanılan Takım / Currently Using Tool
- Инструменты, которые используются в настоящее время
- Şu Anki Kesme Durumu / Current Cutting Condition
- Режимы резания
 - RPM ya da vc(m/min) / - RPM or vc(m/min)
 - RPM или Vp(м/мин)
 - vf(mm/min) ya da fn(mm/rev)
 - vf(mm/min) or fn(mm/rev) vf (mm/min.) oder fn (mm/Umdr.)
 - Kesme Derinliği / Depth of Cut(mm)
 - Глубина резания (мм)
- Ölçülen Standart Takım Ömrü / Standard of Measuring Tool Life
- Стандартный срок службы инструмента
- Şu Anki Kullanılan Makinalar / Currently Using Machine
- Станок, который используется в настоящее время
 - İşleme Merkezi / Machining Center
 - Обрабатывающий центр
 - Genel Torna / General Lathe
 - Общий токарный станок
 - CNC Torna / CNC Lathe
 - Станок с ЧПУ



*konusulan
the spoken kalite...
quality...*

EKONOMİK KESİCİLER

EKONOMİK KESİCİLER

MULTI FUNCTIONAL CUTTING TOOLS

МНОГОФУНКЦИОНАЛЬНЫЙ MULTI TOOL





AKKO **A** **EK** **R** - **D2.25** x **20**

X **C** **.** **.** **10** **T3** **04**

2 Kesiş Stili / Cutter Style / Тип режущего инструмента

EK : Ekonomik Kesici / Economic Cutting
Экономичное точение

3 Kesme Yönü / Cutting Direction / Направление резания

11 Kalınlık / Thickness / Толщина

01 s = 1.59
T1 s = 1.98
02 s = 2.38
T2 s = 2.78
03 s = 3.18
T3 s = 3.97
04 s = 4.76
05 s = 5.56
06 s = 6.35
07 s = 7.94
09 s = 9.52

4 Delme Derinliği / Drilling Depth / Глубина сверления

5 Takım Çapı / Tool Diameter / Диаметр режущей части

6 Uç Şekli / Insert Form / Форма пластины

X **Q**

8 Toleranslar / Tolerance Classes / Точность

	IC	M	S
A	± 0.025	± 0.005	± 0.025
C	± 0.025	± 0.013	± 0.025
E	± 0.025	± 0.025	± 0.025
F	± 0.013	± 0.005	± 0.025
G	± 0.025	± 0.025	± 0.130
H	± 0.013	± 0.013	± 0.025
J	± 0.05-0.15	± 0.005	± 0.025
K	± 0.05-0.15	± 0.013	± 0.025
L	± 0.05-0.15	± 0.025	± 0.025
M	± 0.05-0.15	± 0.08-0.20	± 0.130
N	± 0.05-0.15	± 0.08-0.20	± 0.025
U	± 0.08-0.25	± 0.13-0.38	± 0.130

IC: Daire Ölçüsü / Inscribed Circle
M: Şekle Göre / Refer to Figure
S: Kalınlık / Thickness

9 Uç Tipi / Type of Insert / Форма отверстия

A **J** **T**
 $\beta = 70-90^\circ$ $\beta = 40-60^\circ$

B **M** **U**
 $\beta = 70-90^\circ$ $\beta = 40-60^\circ$

C **N** **W**
 $\beta = 70-90^\circ$ $\beta = 40-60^\circ$

F **Q** **X** Special / Özel
 $\beta = 40-60^\circ$

G **R**

H
 $\beta = 70-90^\circ$

10 Kesme Kenar Uzunluğu / Cutting Edge Length / Длина режущей кромки

12 Köşe Konfigürasyonu / Corner Radius / Радиус при вершине

01 RE=0.1 12 RE=1.2
02 RE=0.2 16 RE=1.6
04 RE=0.4 24 RE=2.4
08 RE=0.8

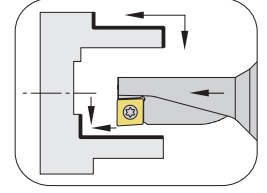
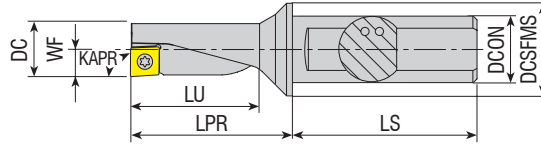

Takım Kodu
Ordering Code
Код для заказа

Stok
Stock
Наличие

Takım Ölçüleri (mm)
Dimension (mm)
Размеры (мм)

Kesici Uç
Insert
Пластина

Yedek Parçaları / Spare Parts / Запасные части

Sıkma Vidası
Screw
Зажимной винт

Tork Anahtar
Torx Key
Торх Ключ

R	L	DC	DCON	DCSFMS	LU	LPR	LS	WF	Kesici Uç Insert Пластина	Sıkma Vidası Screw Зажимной винт	Tork Anahtar Torx Key Торх Ключ
●	●	8	10	12	18	22	38	4	XC.. 040104	3006-M1.8x4	80-T06
●	●	10	12	16	22.5	27.5	42	5	XC.. 050204	3006-M2x4	80-T07
●	●	12	16	20	27	33	45	6	XC.. 060204	3007-M2.2x5	80-T08
●	●	14	16	20	31.5	38	45	7	XC.. 070304	3008-M2.5x6	80-T15
●	●	16	20	25	36	44	50	8	XC.. 080304	3008-M3x6	80-T20
●	●	18	25	32	40.5	53.5	56	9	XC.. 09T304	4015-M3.5x9	80-T15
●	●	20	25	32	45	55	56	10	XC.. 10T304	4020-M4.5x10	80-T20
●	●	25	32	40	56.5	69	60	12.5	XC.. 130404	4020-M4.5x12	80-T20
●	●	32	32	50	72	88	60	16	XC.. 170504	4020-M4.5x12	80-T20

R: Sağ / Right / Правый L: Sol / Left / Левый

● Stokta / In Stock / В наличии ○ Stokta Yok / Non Stock Item / Нет в наличии

CRTZT-ISCR-TGTC-KRLY Ucuna Uygundur. / Compatible with CRTZT-ISCR-TGTC-KRLY Insert.

Под пластину CRTZT-ISCR-TGTC-KRLY

Sipariş Örneği/Ordering Example/Образец заказа
 1 ad./pcs./шт. AEKR-D2.25X8 XC.. 040104

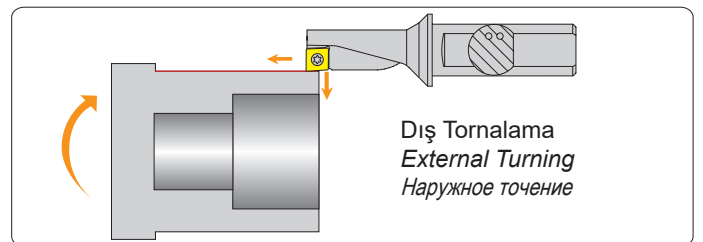
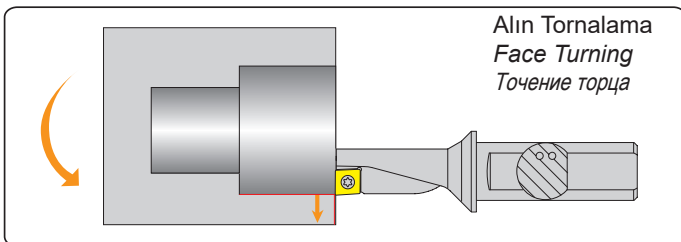
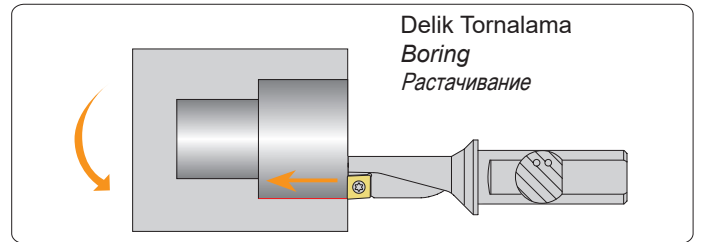
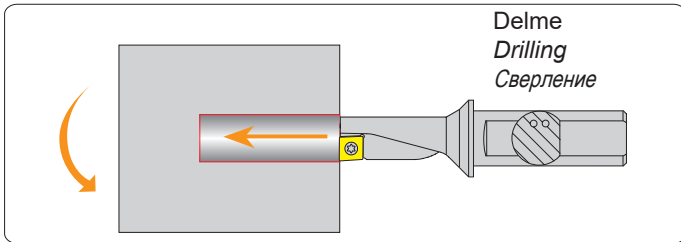
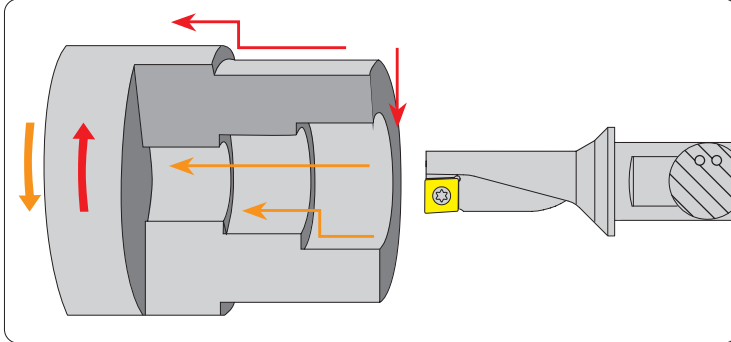



BARALAR

AYARLI DELİK İŞLEME BARALARI
ADJUSTABLE BORING HEADS
РЕГУЛИРУЕМЫЕ РАСТОЧНЫЕ ГОЛОВКИ

*konusulan
the spoken kalite...
quality...*

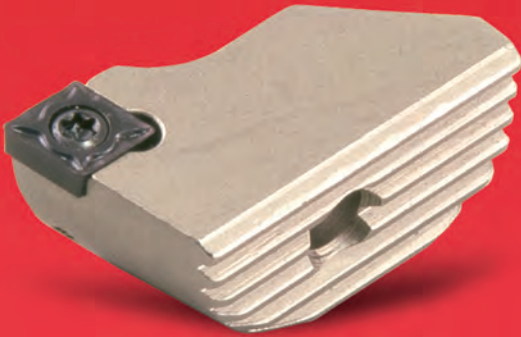

AKKO

A

1

BH

2

R

3

D18x22

4

W16

5

L90

6

CC06

7

2 Kesiş Stili / Cutter Style / Тип режущего инструмента

BH : Delik İşleme / Boring Head
Расточная головка

3 İşlem Tipi / Cutter Type / Виды растачивания

R : Kaba Baralama / Rough Boring
Черновое точение
F : Hassas Baralama / Fine Boring
Чистовое точение

5 Montaj Formu / Assembly Form / Тип хвостовика

W : Weldon

4 Ölçü Aralığı / Boring Range / Диаметр растасчивания

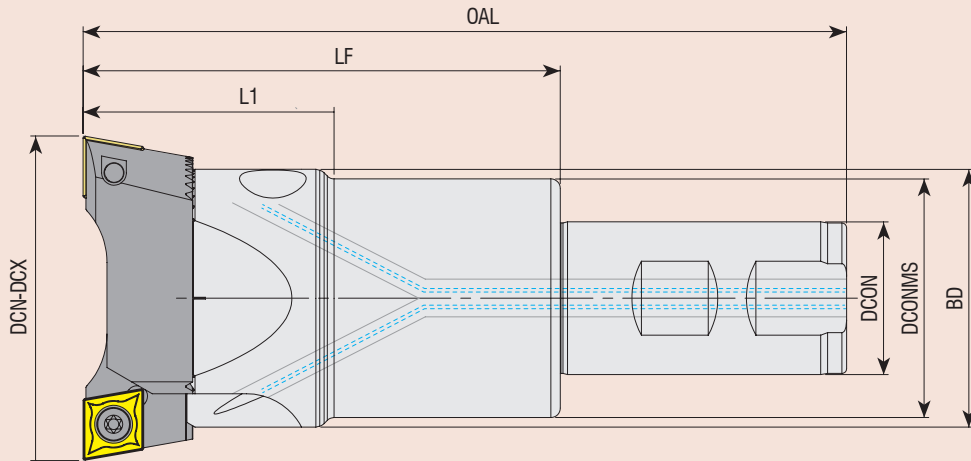

6 Takım Boyu / Tool Length / Длина инструмента

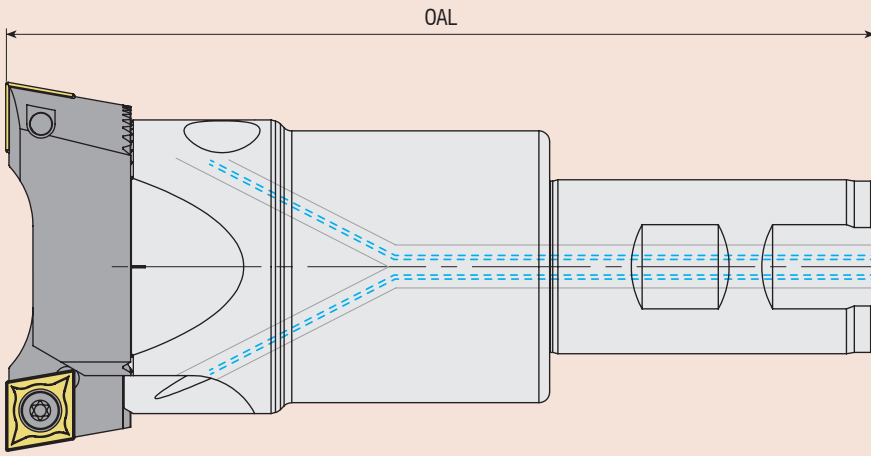

7 Kesici Uç / Insert / Пластина

CC06 : CC.. 0602..
CC09 : CC.. 09T3..
CC12 : CC.. 1204..

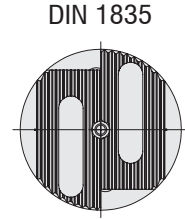
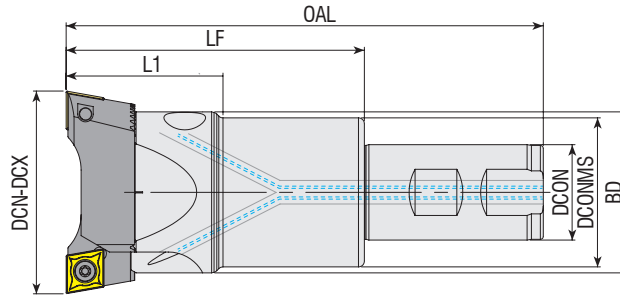

Takım Kodu
Ordering Code
Код для заказа

Stok
Stock
Наличие

Takım Ölçüleri (mm)
Dimension (mm)
Размеры (мм)

Kartuş
Cartridge
Картридж

Bara Gövde Takım Kodu
Boring Head Body Code
Корпус расточной головки

Ölçü Aralığı
Boring Range
Диаметр
DCN-DCX

DCON DCONMS BD OAL LF L1

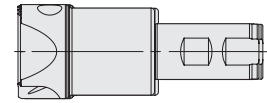

Takım Kodu	Stok	Ölçü Aralığı	DCON	DCONMS	BD	OAL	LF	L1	Kartuş	Bara Gövde Takım Kodu
Ordering Code	Stock	Boring Range							Cartridge	Boring Head Body Code
Код для заказа	Наличие	Диаметр							Картридж	Корпус расточной головки
		DCN-DCX								
ABHR-D18x22-W16-L90-CC06	●	18-22	16	-	-	90	42	-	AK.. 18-22	ABHRS-D16x42-W16-L90
ABHR-D18x22-W16-L150-CC06	●	18-22	16	-	-	150	102	-		ABHRS-D16x102-W16-L150
ABHR-D18x22-W16-L200-CC06	●	18-22	16	-	-	200	152	-		ABHRS-D16x152-W16-L200
ABHR-D22x28-W20-L100-CC06	●	22-28	20	-	-	100	50	-	AK.. 22-28	ABHRS-D20x50-W20-L100
ABHR-D22x28-W20-L150-CC06	●	22-28	20	-	-	150	100	-		ABHRS-D20x100-W20-L150
ABHR-D22x28-W20-L200-CC06	●	22-28	20	-	-	200	150	-		ABHRS-D20x150-W20-L200
ABHR-D28x38-W20-L110-CC06	●	28-38	20	25	-	110	60	-	AK.. 28-38	ABHRS-D25x60-W20-L110
ABHR-D28x38-W20-L160-CC06	●	28-38	20	25	-	160	110	-		ABHRS-D25x110-W20-L160
ABHR-D28x38-W20-L230-CC06	●	28-38	20	25	-	230	180	-		ABHRS-D25x180-W20-L230
ABHR-D36x50-W25-L120-CC06	●	36-50	25	32	-	120	64	-	AK.. 36-50	ABHRS-D32X64-W25-L120
ABHR-D36x50-W25-L170-CC06	●	36-50	25	32	-	170	114	-		ABHRS-D32X114-W25-L170
ABHR-D36x50-W25-L250-CC06	●	36-50	25	32	-	250	194	-		ABHRS-D32X194-W25-L250
ABHR-D36x50-W25-L120-CC09	●	36-50	25	32	-	120	64	-	AK.. 36-50-09	ABHRS-D32X64-W25-L120
ABHR-D36x50-W25-L170-CC09	●	36-50	25	32	-	170	114	-		ABHRS-D32X114-W25-L170
ABHR-D36x50-W25-L250-CC09	●	36-50	25	32	-	250	194	-		ABHRS-D32X194-W25-L250
ABHR-D50x68-W32-L140-CC09	●	50-68	32	40	-	140	80	-	AK.. 50-68	ABHRS-D40x80-W32-L140
ABHR-D50x68-W32-L200-CC09	●	50-68	32	40	-	200	140	-		ABHRS-D40x140-W32-L200
ABHR-D50x68-W32-L280-CC09	●	50-68	32	40	-	280	220	-		ABHRS-D40x220-W32-L280
ABHR-D50x68-W32-L140-CC12	●	50-68	32	40	-	140	80	-	AK.. 50-68-12	ABHRS-D40x80-W32-L140
ABHR-D50x68-W32-L200-CC12	●	50-68	32	40	-	200	140	-		ABHRS-D40x140-W32-L200
ABHR-D50x68-W32-L280-CC12	●	50-68	32	40	-	280	220	-		ABHRS-D40x220-W32-L280
ABHR-D68x90-W32-L160-CC12	●	68-90	32	50	54	160	100	50	AK.. 68-90	ABHRS-D50x100-W32-L160
ABHR-D68x90-W32-L210-CC12	●	68-90	32	50	54	210	150	50		ABHRS-D50x150-W32-L210
ABHR-D68x90-W32-L280-CC12	●	68-90	32	50	54	280	220	50		ABHRS-D50x220-W32-L280
ABHR-D90x120-W32-L140-CC12	●	90-120	32	63	72	140	80	63	AK.. 90-120	ABHRS-D63x80-W32-L140
ABHR-D90x120-W40-L200-CC12	●	90-120	40	63	72	200	130	63		ABHRS-D63x130-W40-L200
ABHR-D90x120-W40-L300-CC12	●	90-120	40	63	72	300	230	63		ABHRS-D63x230-W40-L300
ABHR-D120x160-W40-L210-CC12	●	120-160	40	80	95	210	140	75	AK.. 120-160	ABHRS-D80x140-W40-L210
ABHR-D120x160-W40-L300-CC12	●	120-160	40	80	95	300	230	75		ABHRS-D80x230-W40-L300
ABHR-D160x200-W40-L210-B-CC12	●	160-200	40	80	95	210	140	75	AK.. 160-800	ABHRS-D80x140-W40-L210
ABHR-D160x200-W40-L300-B-CC12	●	160-200	40	80	95	300	230	75		ABHRS-D80x230-W40-L300

R: Sağ / Right / Правый L: Sol / Left / Левый

● Stokta / In Stock / В наличии ○ Stokta Yok / Non Stock Item / Нет в наличии

Siparişte, gövde ve kartuş set olarak verilecektir. / When ordered, body and cartridge will be sent as set.

Картриджи поставляются в комплекте

Sipariş Örneği/Ordering Example/Образец заказа

1 ad./pcs./шт. ABHR-D18x22-W16-L90-CC06

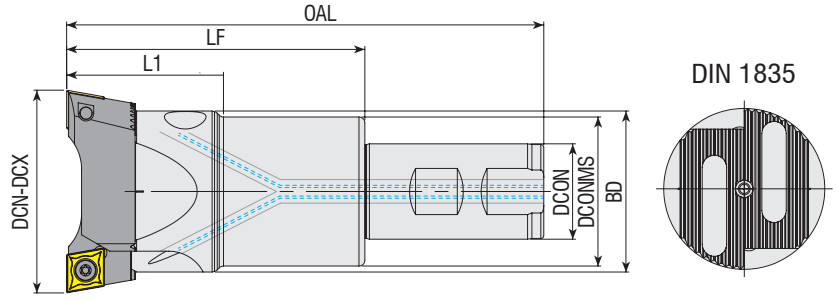

DIN 1835

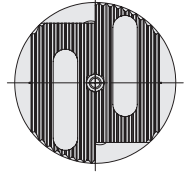

Yedek Parçaları / Spare Parts / Запасные части

Takım Kodu Ordering Code Код для заказа	Stok Stock Наличие	Ölçü Aralığı Boring Range Диаметр DCN-DCX	Takım Ölçüleri (mm) Dimension (mm) Размеры (мм)					Yedek Parçaları / Spare Parts / Запасные части					
			DCON	DCONMS	BD	OAL	LF	L1	Montaj Vidası Mounting Screw Монтажный винт	Montaj Vida Anahtarı Mounting Screw Key Ключ	Pabuç Clamp Ползун	Ayar Vidası Adjusting Screw Регулировочный винт	Ayar Vida Anahtarı Allen Key Ключ
ABHRS-D16x42-W16-L90	●	18-22	16	-	-	90	42	-					
ABHRS-D16x102-W16-L150	●	18-22	16	-	-	150	102	-	2525-M3x14	AAL-02-2.5	ABKS-D16	2715-M3x4	
ABHRS-D16x152-W16-L200	●	18-22	16	-	-	200	152	-					
ABHRS-D20x50-W20-L100	●	22-28	20	-	-	100	50	-					
ABHRS-D20x100-W20-L150	●	22-28	20	-	-	150	100	-	2503-M4x15	AAL-03-3	ABKS-D20	2715-M3x5	AAL-09-1.5
ABHRS-D20x150-W20-L200	●	22-28	20	-	-	200	150	-					
ABHRS-D25x60-W20-L110	●	28-38	20	25	-	110	60	-					
ABHRS-D25x110-W20-L160	●	28-38	20	25	-	160	110	-	2503-M4x20	AAL-03-3	ABKS-D25	2715-M3x8	
ABHRS-D25x180-W20-L230	●	28-38	20	25	-	230	180	-					
ABHRS-D32X64-W25-L120	●	36-50	25	32	-	120	64	-					
ABHRS-D32X114-W25-L170	●	36-50	25	32	-	170	114	-	2504-M5x25	AAL-05-4	ABKS-D32	2702-M4x12	AAL-01-2
ABHRS-D32X194-W25-L250	●	36-50	25	32	-	250	194	-					
ABHRS-D40x80-W32-L140	●	50-68	32	40	-	140	80	-					
ABHRS-D40x140-W32-L200	●	50-68	32	40	-	200	140	-	2505-M6x30	AAL-07-5	ABKS-D40	2725-M5x16	
ABHRS-D40x220-W32-L280	●	50-68	32	40	-	280	220	-					AAL-02-2.5
ABHRS-D50x100-W32-L160	●	68-90	32	50	54	160	100	50					
ABHRS-D50x150-W32-L210	●	68-90	32	50	54	210	150	50	2506-M8x35	AAL-08-6	ABKS-D50	2725-M5x12	
ABHRS-D50x220-W32-L280	●	68-90	32	50	54	280	220	50					
ABHRS-D63x80-W32-L140	●	90-120	32	63	72	140	80	63					
ABHRS-D63x130-W40-L200	●	90-120	40	63	72	200	130	63	2508-M10x40	AAL-11-8	ABKS-D63	2703-M6x16	AAL-03-3
ABHRS-D63x230-W40-L300	●	90-120	40	63	72	300	230	63					
ABHRS-D80x140-W40-L210	●	120-160	40	80	95	210	140	75	2510-M12x40				
ABHRS-D80x230-W40-L300	●	120-160	40	80	95	300	230	75					
ABHRS-D80x140-W40-L210	●	160-200	40	80	95	210	140	75	2510-M12x40	AAL-12-10	ABKS-D80	2704-M8x25	AAL-05-4
ABHRS-D80x230-W40-L300	●	160-200	40	80	95	300	230	75					

R: Sağ / Right / Правый L: Sol / Left / Левый

● Stokta / In Stock / В наличии ○ Stokta Yok / Non Stock Item / Нет в наличии

Sipariş Örneği/Ordering Example/Образец заказа

1 ad./pcs./шт. ABHRS-D16x42-W16-L90

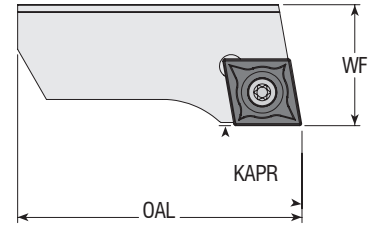

Takım Kodu Ordering Code Код для заказа	Stok Stock Наличие	Takım Ölçüleri (mm) Dimension (mm) Размеры (мм)		Kesici Uç Insert Пластина	Yedek Parçaları / Spare Parts / Запасные части		
		Ölçü Aralığı Boring Range	WF		OAL	Sıkma Vidası Screw Зажимной винт	Tork Anahtar Torx Key Торх Ключ
AKSR 18-22	●	18-22	9	15	CC.T 0602..	4008-M2.5x6	80-T08
AKSR 22-28	●	22-28	10	19			
AKSR 28-38	●	28-38	13	23			
AKSR 36-50	●	36-50	16	32	CC.T 09T3..	4015-M3.5x8	80-T15
AKSR 36-50-09	●	36-50	16	32			
AKSR 50-68	●	50-68	20	40			
AKSR 50-68-12	●	50-68	20	40	CC.T 1204..	1020-M5x11	80-T20
AKSR 68-90	●	68-90	23	54			
AKSR 90-120	●	90-120	28	70			
AKSR 120-160	●	120-160	32	95			
AKSR 160-800	●	160-800	32	120			

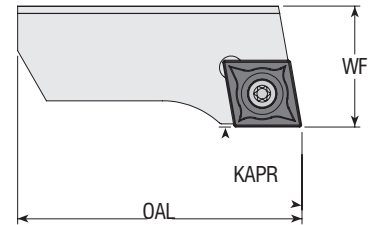

Takım Kodu Ordering Code Код для заказа	Stok Stock Наличие	Takım Ölçüleri (mm) Dimension (mm) Размеры (мм)		Kesici Uç Insert Пластина	Yedek Parçaları / Spare Parts / Запасные части		
		Ölçü Aralığı Boring Range	WF		OAL	Sıkma Vidası Screw Зажимной винт	Tork Anahtar Torx Key Торх Ключ
AKCR 28-38	●	28-38	12.8	23	CC.T 0602..	4008-M2.5x6	80-T08
AKCR 36-50	●	36-50	15.8	32			
AKCR 36-50-09	●	36-50	15.8	32			
AKCR 50-68	●	50-68	19.7	40	CC.T 09T3..	4015-M3.5x8	80-T15
AKCR 50-68-12	●	50-68	19.7	40			
AKCR 68-90	●	68-90	22.7	54			
AKCR 90-120	●	90-120	27.7	70	CC.T 1204..	1020-M5x11	80-T20
AKCR 120-160	●	120-160	31.7	95			
AKCR 160-800	●	160-800	31.7	120			

R: Sağ / Right / Правый L: Sol / Left / Левый

● Stokta / In Stock / В наличии ○ Stokta Yok / Non Stock Item / Нет в наличии
ISO Uçuna Uygundur. / Compatible with ISO Insert. / Под пластину ISO.

Sipariş Örneği/Ordering Example/Образец заказа
1 ad./pcs./шт. AKSR 18-22

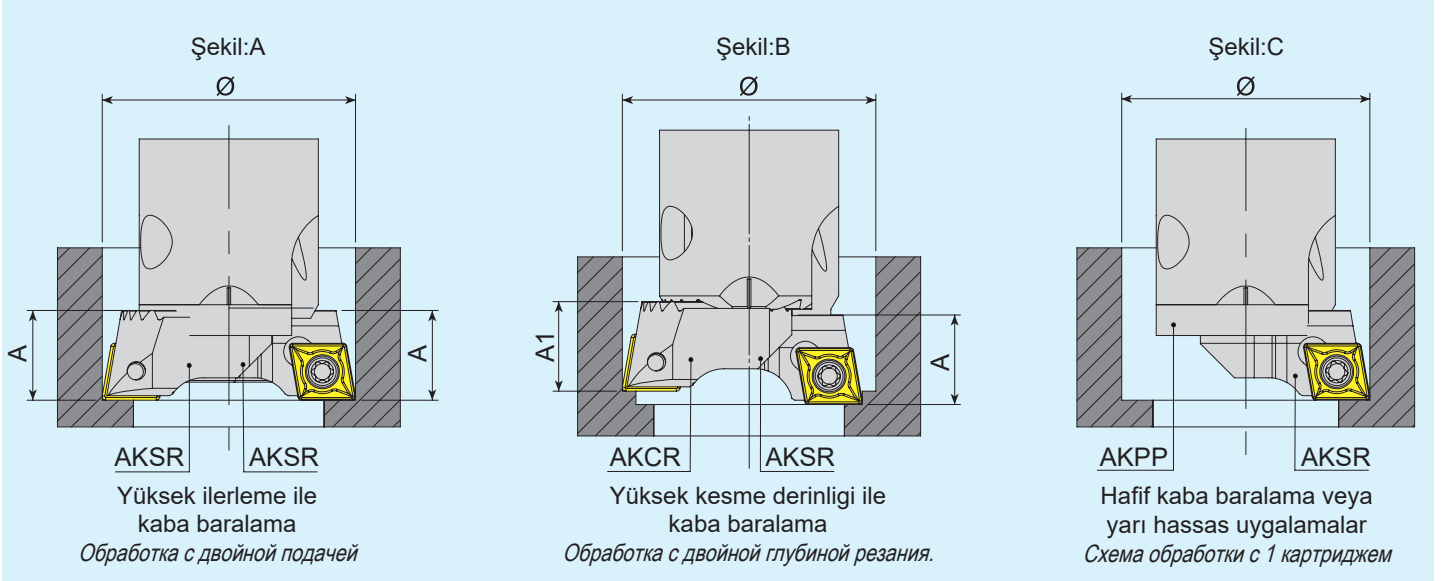

1. Kesici kenarların radyal ayarı, takım ölçme ekipmanı ile yapılmalıdır.
2. İki uçlu baralama takımı, ağır talaş kaldırma işlemini içeren kaba baralama işlemleri içindir.
Çift uçlu baralama takımı ile:
 - Yüksek ilerleme oranında kaba baralama işlemleri için, aynı düzlemdaki iki AKSR kartuşu, aynı radyal mesafeye ayarlanır. (Şekil A)
 - Aynı düzlemde olmayan bir AKCR kartuşu ve bir AKSR kartuşu yüksek derinlikte kaba baralama işlemleri için kullanılır. (Şekil B)
 - i. Kaba baralama işleminde, alınacak paso miktarı tam olarak ikiye bölünüp, düzgün bir kesim sağlanmış olur, ancak bu durumda tur başına ilerleme tek ağız olarak hesaplanmalıdır. ($f=f1$)
 - ii. Hassas baralama işleminde, alınacak paso miktarı AKSR kartuş için ara kaba olarak ve AKCR kartuş için hassas bara olarak çaplar ayarlanır ve bu sayede bazı ara kaba işleme ihtiyacı kalmaz.
3. Tek kartuşlu baralama takımları, normal talaş kaldırma işlemini içeren kaba ve hassas baralama işlemleri içindir. Dişleri koruma plakası, AKPP daima kullanılmalıdır. (Şekil C)

1. Radial setting of the cutting edges should be carried out with tool presetting equipment.
2. Boring bars fitted with two insert pockets are for roughing operations involving heavy chip removal.
The double-insert boring bars include:
 - Two AKSR cartridges on the same plane with two cutting edges set at identical radial distance for high feed rate roughing operations. (fig. A)
 - An AKCR cartridge and an AKSR cartridge not on the same plane for high-depth roughing operations. (fig. B)
 - i. With the rough boring operation, this allows double the cutting width, using only a single feed rate. ($f=f1$)
 - ii. With the finish boring operation, the cutting width is divided so that some of the intermediate machining can be omitted.
3. Boring bars fitted with a single cartridge are for roughing and finishing operations involving normal chip removal. The serrated surface protection plate AKPP should always be used (fig. C)

1. Радиальная установка резцов должна быть выполнена на приборе по предварительной настройке инструмента вне станка.
2. Двурезцовые расточные головки предназначены для высокопроизводительной черновой обработки.
Три схемы сборки:
 - Рисунок А: два картриджа AKSR... устанавливаются в одной плоскости на один диаметр. Это обеспечивает двойную подачу при черновой обработке.
 - Рисунок В: 2 различных картриджа AKSR... и AKCR... устанавливаются с разными вылетами. Это обеспечивает двойную глубину резания.
 - i. Подача устанавливается одна и должна быть не более разницы вылетов A и A1.
 - ii. Распределение припуска по картриджам должно быть равномерным.
3. Рисунок С: используется один из картриджей AKSR... или AKCR..., а так же заглушка AKPP...



konusulan
the spoken kalite...
quality...

FREZELEME TAKIMLARI
MILLING TOOLS
ФРЕЗЕРНЫЙ ИНСТРУМЕНТ



AKKO **A** **EM** **90** **L** - **A** **P** **10**

1 2 3 4 5 6 7

D12 - **W16** - **L100** - **Z01** - **H**

8 9 10 11 12

2 Kesiş Stili / Cutter Style / Тип режущего инструмента

FM: Yüzey Frezeleme Takımları / Face Milling Tools / Торцевые Фрезы
EM: Alın ve Yüzey Parmak Frezeleri / End Face Milling Tools / Торцевые Фрезы
CM: Pah Kırma Parmak Frezeleri / Chamfering End Milling Tools / Концевые Спиральные Фрезы Для Снятия Фаски
HM: Helis Parmak Frezeleri / Helix End Milling Tools / Концевые Фрезы Для Снятия Фаски
TSM: T Kanal Frezeleri / T Slot Milling Tools / Т-Образные Фрезы
HFM: Yüksek İlerleme Frezeleme Takımları / High Feed Milling Tools / Высокопроизводительные Концевые Фрезы
PMR: Küresel Uçlu Parmak Frezeleri / Ball Nose End Milling Tools / Сферические Концевые Фрезы
SDM: Disk Frezeler / Slot Disc Milling / Дисковые Трехсторонние Фрезы
CBM: Silindirik Alyan Başlı Vida Havşalarını Açma Frezeleri / Countersink Milling Tool for Cylindrical Allen Head Screws
Зенковка Для Отверстий Под Винты С Цилиндрической И Шестигранной Головкой (Гост 974-1)

3 Freze Yanaşma Açısı / Lead Angle / Угол в плане

90° - 75° - 60° - 45°
20° - 15° - 11° - 5° - 0°

4 Freze Yanaşma Açısı / Lead Angle / Исполнение

L: Sol - Left / Links / Левая сторона
C: Baskı Pabuçu - Clamp / Прижим
S: Altlık - Shim / опорными пластинами
CL: Baskı Pabuçlu Sol Yön - Left Way with Clamp
Левое вращение, крепление СМП прихватом
CS: Baskı Pabuçlu Altlıklı - Clamp with Shim
Крепление СМП прихватом, с опорными пластинами
CSL: Baskı Pabuçlu Altlıklı Sol Yön - Left Way Clamp with Shim
Левое вращение, крепление СМП прихватом, с опорными пластинами

5 Uç Tipi / Type of Insert / Форма пластины

C	D	E	K
L	R	S	T
V	W	A	B
H	M	O	P

6 Serbest Uç Açısı / Clearance angle of Insert / Задний угол пластины

A	B	C
D	E	F
G	N	P

7 Kesme Kenar Uzunluğu / Cutting Edge Length / Длина режущей кромки

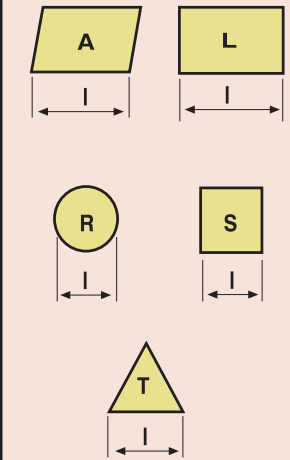

8 Takım Çapı / Tool Diameter / Диаметр режущей части

9 Montaj Formu ve Çapı / Assembly Form and Diameter / Тип и диаметр хвостовика

A,B,C,D: ISO'ya göre montaj formu / Assembly Form and Diameter / Под ISO A,B,C,D Тип сборки
S: Silindirik Şaft / Cylindrical Shank / Zylindrischer Schaft
W: Weldon

10 Takım Boyu / Tool Length / Длина инструмента

11 Etkili Diş Adedi / Number of Effective Tooth / Количество эффективных зубов

12 İçten Soğutmalı / With Coolant Hole / Канал для СОЖ

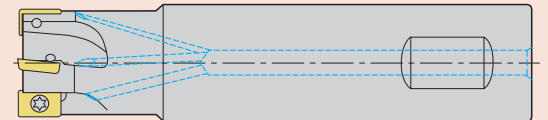

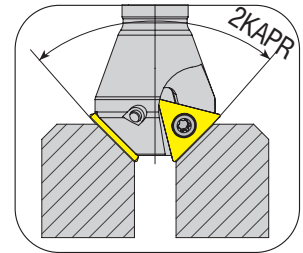
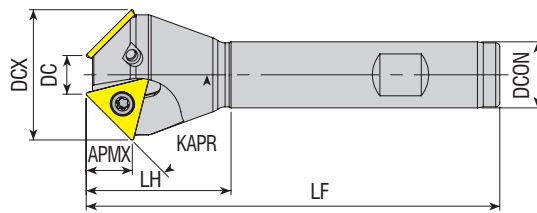

Takım Kodu Ordering Code Код для заказа	Stok Stock Наличие	Takım Ölçüleri (mm) Dimension (mm) Размеры (мм)								Kesici Uç Insert Пластина	Yedek Parçaları / Spare Parts / Запасные части		
		KAPR	DC	DCX	DCON	LF	LH	ZEPF	APMX		Sıkma Vidası Screw Зажимной винт	Tork Anahtar Torx Key Торкс Ключ	
ACM10-TC16-D17X22-W16-L90-Z01	●	10°	17	22	16	90	30	1	15.2	TC.T 16T304	4015-M3.5x9	80-T15	
ACM15-TC16-D17X24-W16-L90-Z01	●	15°	17	24	16	90	30	1	14.9				
ACM15-TC16-D22X29-W16-L100-Z01	●	15°	22	29	16	100	30	1	14.9				
ACM15-TC16-D30X37-W20-L100-Z02	●	15°	30	37	20	100	35	2	14.9				
ACM15-TC16-D35X42-W20-L100-Z03	●	15°	35	42	20	100	38	3	14.9				
ACM15-TC16-D52X59-W25-L110-Z03	●	15°	52	59	25	110	40	3	14.9				
ACM17.5-TC16-D17X25-W16-L90-Z01	●	17.5°	17	25	16	90	30	1	14.7				
ACM18.5-TC16-D21.3X30-W20-L100-Z02	●	18.5°	21.3	30	20	100	30	2	13.5				TC.T 16T308
ACM20-TC16-D12X22-W16-L100-Z01	●	20°	12	22	16	100	30	1	14.4				
ACM20-TC16-D17X27-W16-L100-Z01	●	20°	17	27	16	100	30	1	14.4				
ACM20-TC16-D23X33-W20-L100-Z02	●	20°	23	33	20	100	30	2	14.4				
ACM20-TC16-D28X38-W20-L100-Z02	●	20°	28	38	20	100	35	2	14.4				
ACM20-TC16-D35X45-W20-L100-Z03	●	20°	35	45	20	100	40	3	14.4				
ACM20-TC16-D39X49-W20-L100-Z03	●	20°	39	49	20	100	40	3	14.4				
ACM20-TC16-D45X55-W25-L110-Z03	●	20°	45	55	25	110	40	3	14.4				
ACM20-TC16-D51X61-W25-L110-Z03	●	20°	51	61	25	110	40	3	14.4				
ACM22.5-TC16-D17X28-W16-L100-Z01	●	22.5°	17	28	16	100	30	1	14.2				
ACM25-TC16-D17X29-W16-L100-Z01	●	25°	17	29	16	100	30	1	13.9				
ACM30-TC16-D6X20-W16-L100-Z01	●	30°	6	20	16	100	30	1	13.3				
ACM30-TC16-D15X30-W16-L100-Z01	●	30°	15	30	16	100	30	1	13.3				
ACM30-TC16-D17.5X32.5-W20-L100-Z02	●	30°	17.5	32.5	20	100	30	2	13.3				
ACM30-TC16-D20X35-W16-L100-Z02	●	30°	20	35	16	100	35	2	13.3				
ACM30-TC16-D30X45-W20-L100-Z02	●	30°	30	45	20	100	40	2	13.3				
ACM30-TC16-D35X50-W20-L100-Z03	●	30°	35	50	20	100	40	3	13.3				
ACM30-TC16-D45X60-W25-L110-Z03	●	30°	45	60	25	110	40	3	13.3				
ACM45-TC09-D7X18-W16-L100-Z02	●	45°	7	18	16	100	25	2	5.9	TC.T 090204	3007-M2.2x5	80-T07	
ACM45-TC11-D11X24-W16-L100-Z02	●	45°	11	24	16	100	25	2	6.9	TC.T 110204	3008-M2.5x6	80-T08	
ACM45-TC16-D5X26-W16-L100-Z01	●	45°	5	26	16	100	30	1	10.8	TC.T 16T304	4015-M3.5x9	80-T15	
ACM45-TC16-D10X31-W16-L100-Z02	●	45°	10	31	16	100	35	2	10.8				
ACM45-TC16-D10X31-W20-L100-Z02	●	45°	10	31	20	100	35	2	10.8				
ACM45-TC16-D18X39-W16-L100-Z02	●	45°	18	39	16	100	40	2	10.8				
ACM45-TC16-D18X39-W20-L100-Z02	●	45°	18	39	20	100	40	2	10.8				
ACM45-TC16-D20X41-W20-L100-Z02	●	45°	20	41	20	100	40	2	10.8				
ACM45-TC16-D30X51-W20-L100-Z02	●	45°	30	51	20	100	40	2	10.8				
ACM55-TC16-D16X40-W20-L100-Z03	●	55°	16	40	20	100	40	3	8.7				
ACM62-TC16-D14X40-W20-L100-Z03	●	62°	14	40	20	100	40	3	7.1				
ACM72-TC16-D14X42-W20-L100-Z03	●	72°	14	42	20	100	40	3	4.6				

R: Sağ / Right / Правый L: Sol / Left / Левый

● Stokta / In Stock / В наличии ○ Stokta Yok / Non Stock Item / Нет в наличии

ISO Ucuna Uygunudur. / Compatipble with ISO Insert. / Под пластину ISO.

Sipariş Örneği/Ordering Example/Образец заказа

1 ad./pcs./шт. ACM10-TC16-D17X22-W16-L90-Z01

Kesme Hesabı : S 367 / Cutting Calculation : P 367 / Расчет режимов резания: стр. 367

S-SİSTEM PAH FREZELER

S-SYSTEM CHAMFERING END MILLS

S-TİPİ KONCEVYİE FREZİLER İÇİN ÇENKİTİE FAKSİ (ZENKOVKİ)

KAPR=45°

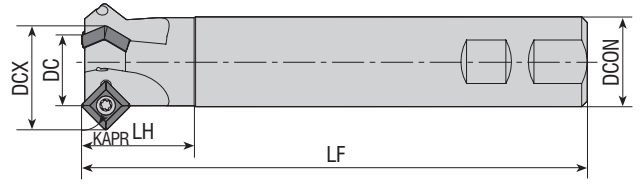

Takım Kodu Ordering Code Код для заказа	Stok Stock Наличие	Takım Ölçüleri (mm) Dimension (mm) Размеры (мм)								Kesici Uç Insert Пластина	Yedek Parçaları / Spare Parts / Залпасные части		
		KAPR	DC	DCX	DCON	LF	LH	ZEFP	a		Sıkma Vidası Screw Зажимной винт	Tork Anahtar Torx Key Торк Ключ	
ACM45-SP1104-D12x26-W20-L150-Z01	●	45°	12	26	20	150	30	1	-	SPGT 110408	4015-M4x9	80-T15	
ACM45-SP1104-D25x39-W25-L150-Z02	●	45°	25	39	25	150	35	2	-				
ACM45-SP1104-D32x46-W32-L150-Z03	●	45°	32	46	32	150	40	3	-				

ZCC Ucuna Uygundur. / Compatible with ZCC Insert. / Под пластину ZCC

HELİS PAH FREZELEME TAKIMLARI

HELIX CHAMFER MILLING TOOLS

КУКУРУЗНЫЕ ФРЕЗЫ İÇİN ÇENKİTİE FAKSİ

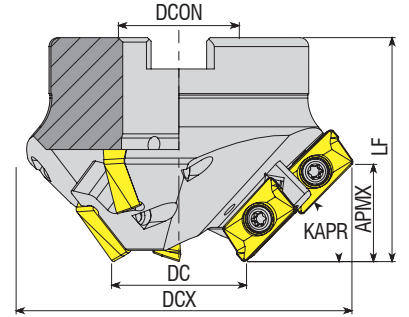

Takım Kodu Ordering Code Код для заказа	Stok Stock Наличие	Takım Ölçüleri (mm) Dimension (mm) Размеры (мм)								Kesici Uç Insert Пластина	Yedek Parçaları / Spare Parts / Залпасные части		
		ZEFP		KAPR	DC	DCX	DCON	APMX	LF		Sıkma Vidası Screw Зажимной винт	Tork Anahtar Torx Key Торк Ключ	
		Toplam Total Gesamt	Etkili Effective Effektiv										
AHM15-AP16-D35x93-A27-Z0306-H	●	6	3	15	35	93	27	8	50	AP. 1604..	4015-M4x11	80-T15	
AHM30-AP16-D35x87-A27-Z0306-H	●	6	3	30	35	87	27	15	50				
AHM45-AP16-D35x77-A27-Z0306-H	●	6	3	45	35	77	27	21.5	50				
AHM60-AP16-D35x65-A22-Z0306-H	●	6	3	60	35	65	22	26.5	50				
AHM75-AP16-D35x50-A22-Z0306-H	●	6	3	75	35	50	22	29.5	50				

R: Sağ / Right / Правый L: Sol / Left / Левый

● Stokta / In Stock / В наличии ○ Stokta Yok / Non Stock Item / Нет в наличии

ISO Ucuna Uygundur. / Compatible with ISO Insert. / Под пластину ISO.

Sipariş Örneği/Ordering Example/Образец заказа

1 ad./pcs./шт. ACM45-SP1104-D12x26-W20-L150-Z01

Kesme Hesabı : S 367 / Cutting Calculation : P 367 / Расчет режимов резания: стр. 367

SİLİNDİRİK ALYAN BAŞLI VİDA (DIN 974-1) HAVŞALARINI AÇMA FREZELERİ
 COUNTERSINK MILLING TOOL FOR CYLINDRICAL ALLEN HEAD SCREWS (DIN 974-1)
 ЗЕНКОВКА ДЛЯ ОТВЕРСТИЙ ПОД ВИНТЫ С ЦИЛИНДРИЧЕСКОЙ И ШЕСТИГРАННОЙ ГОЛОВКОЙ (DIN 974-1)

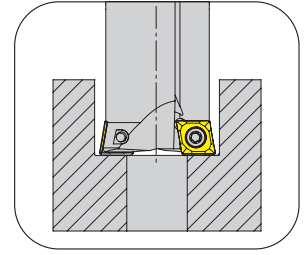
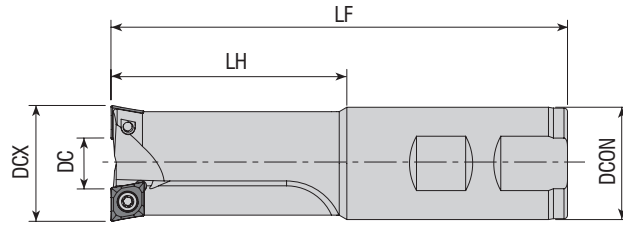

Takım Kodu Ordering Code Код для заказа	Stok Stock Наличие	Takım Ölçüleri (mm) Dimension (mm) Размеры (мм)						Kesici Uç Insert Пластина	Yedek Parçaları / Spare Parts / Запасные части	
		DC	DCX	DCON	LH	LF	Kullanılan Vidalar For Screws Für Schraube		Sıkma Vidası Screw Зажимной винт	Tork Anahtar Torx Key Торх Ключ
ACBM-CC06-D17X6-W16-L150-Z02	●	6	17	16	30	150	-	CC.. 060204	3008-M2.5x6	80-T08
ACBM-CC06-D18X7-W16-L100-Z02-H	●	7	18	16	32	100	M10			
ACBM-CC06-D18X7-W16-L160-Z02-H	●	7	18	16	32	160	M10			
ACBM-CC06-D20X9-W20-L100-Z02-H	●	9	20	20	40	100	M12			
ACBM-CC06-D20X9-W20-L160-Z02-H	●	9	20	20	38	160	M12			
ACBM-CC09-D26X8.5-W25-L130-Z02-H	●	8.5	26	25	50	130	M16	CC.. 09T304	4015-M3.5x9	80-T15
ACBM-CC09-D26X8.5-W25-L200-Z02-H	●	8.5	26	25	50	200	M16			
ACBM-CC09-D30X12.5-W32-L130-Z02-H	●	12.5	30	32	65	130	-			
ACBM-CC09-D33X15.5-W32-L130-Z02-H	●	15.5	33	32	65	130	M20			
ACBM-CC09-D33X15.5-W32-L200-Z02-H	●	15.5	33	32	65	200	M20			
ACBM-SP06-D15X4-W16-L160-Z02-H	●	4	15	16	80	160	M8	SP. 060204	3007-M2.2x5	80-T07

R: Sağ / Right / Правый L: Sol / Left / Левый

● Stokta / In Stock / В наличии ○ Stokta Yok / Non Stock Item / Нет в наличии
 ISO Uçuna Uygundur. / Compatible with ISO Insert. / Под пластину ISO.

Sipariş Örneği/Ordering Example/Образец заказа

1 ad./pcs./шт. ACBM-CC06-D17X6-W16-L150-Z02

Kesme Hesabı : S 367 / Cutting Calculation : P 367 / Расчет режимов резания: стр. 367



KAPR=90°

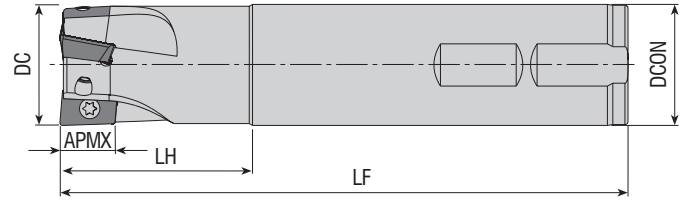

Takım Kodu Ordering Code Код для заказа	Stok Stock Наличие	Takım Ölçüleri (mm) Dimension (mm) Размеры (мм)						Kesici Uç Insert Пластина	Yedek Parçaları / Spare Parts / Запасные части				
		DC	ZEPF	DCON	LF	LH	APMX		Sıkma Vidası Screw Зажимной винт	Tork Anahtar Torx Key Торх Ключ			
AEM90-AD1505-D25-W25-L150-Z02	●	25	2	25	150	50	14.30						
AEM90-AD1505-D30-W25-L150-Z03	●	30	3	25	150	40	14.30				AD.. 1505..	4015-M4x9	80-T15
AEM90-AD1505-D32-W32-L150-Z03	●	32	3	32	150	50	14.30						

ISCR Ucuna Uygundur. / Compatible with ISCR Insert. / Под пластину ISCR

KAPR=90°

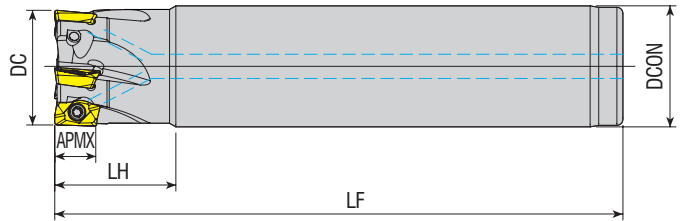

Takım Kodu Ordering Code Код для заказа	Stok Stock Наличие	Takım Ölçüleri (mm) Dimension (mm) Размеры (мм)						Kesici Uç Insert Пластина	Yedek Parçaları / Spare Parts / Запасные части		
		DC	ZEPF	DCON	LF	LH	APMX		Sıkma Vidası Screw Зажимной винт	Tork Anahtar Torx Key Торх Ключ	
AEM90-AD07-D10-C08-L90-Z02-H	●	10	2	8	90	16	6				
AEM90-AD07-D10-C10-L80-Z02-H	●	10	2	10	80	16	6				
AEM90-AD07-D12-C10-L80-Z03-H	●	12	3	10	80	18	6				
AEM90-AD07-D12-C12-L90-Z03-H	●	12	3	12	90	18	6				
AEM90-AD07-D16-C16-L110-Z04-H	●	16	4	16	110	19	6				
AEM90-AD07-D20-C20-L125-Z05-H	●	20	5	20	125	20	6				
AEM90-AD07-D25-C25-L140-Z06-H	●	25	6	25	140	24	6				
AEM90-AD11-D16-C16-L135-Z02-H	●	16	2	16	135	24	9				
AEM90-AD11-D18-C16-L135-Z02-H	●	18	2	16	135	15	9				
AEM90-AD11-D18-C16-L160-Z02-H	●	18	2	16	160	15	9				
AEM90-AD11-D20-C20-L150-Z02-H	●	20	2	20	150	50	9				
AEM90-AD11-D20-C20-L150-Z03-H	●	20	3	20	150	50	9				
AEM90-AD11-D22-C20-L150-Z03-H	●	22	3	20	150	15	9				
AEM90-AD11-D22-C20-L200-Z03-H	●	22	3	20	200	15	9				
AEM90-AD11-D25-C25-L170-Z03-H	●	25	3	25	170	50	9				
AEM90-AD11-D25-C25-L170-Z04-H	●	25	4	25	170	50	9				
AEM90-AD11-D28-C25-L165-Z04-H	●	28	4	25	165	17	9				
AEM90-AD11-D28-C25-L200-Z04-H	●	28	4	25	200	17	9				
AEM90-AD11-D30-C25-L165-Z04-H	●	30	4	25	165	19	9				
AEM90-AD11-D30-C25-L200-Z04-H	●	30	4	25	200	19	9				
AEM90-AD11-D32-C32-L195-Z05-H	●	32	5	32	195	50	9				

R: Sağ / Right / Правый L: Sol / Left / Левый

● Stokta / In Stock / В наличии ○ Stokta Yok / Non Stock Item / Нет в наличии

PRMT Ucuna Uygundur. / Compatible with PRMT Insert. / Под пластину PRMT.

Sipariş Örneği/Ordering Example/Образец заказа

1 ad./pcs./шт. AEM90-AD1505-D25-W25-L150-Z02

Kesme Hesabı : S 367 / Cutting Calculation : P 367 / Расчет режимов резания: стр. 367

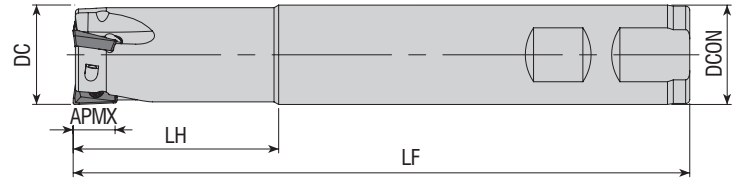

Takım Kodu Ordering Code Код для заказа	Stok Stock Наличие	Takım Ölçüleri (mm) Dimension (mm) Размеры (мм)						Kesici Uç Insert Пластина	Yedek Parçaları / Spare Parts / Запасные части	
		DC	ZEFP	DCON	LF	LH	APMX		Sıkma Vidası Screw Зажимной винт	Tork Anahtar Torx Key Торкс Ключ
AEM90-AD0803-D16-W16-L150-Z02	●	16	2	16	150	30	8	ADMT 0803..	3008-M2.5x5	
AEM90-AD0803-D17-W16-L150-Z02	●	17	2	16	150	30	8			
AEM90-AD0803-D17-W16-L200-Z02	●	17	2	16	200	30	8			
AEM90-AD0803-D20-W20-L150-Z03	●	20	3	20	150	30	8			
AEM90-AD0803-D21-W20-L200-Z03	●	21	3	20	200	30	8			
AEM90-AD10T3-D16-W16-L100-Z02-H	●	16	2	16	100	30	10	ADMT 10T3..	3008-M2.5x6	80-T08
AEM90-AD10T3-D16-W16-L150-Z02	●	16	2	16	150	40	10			
AEM90-AD10T3-D16-C16-L200-Z02	●	16	2	16	200	50	10			
AEM90-AD10T3-D17-W16-L150-Z02	●	17	2	16	150	30	10			
AEM90-AD10T3-D17-W16-L200-Z02	●	17	2	16	200	30	10			
AEM90-AD10T3-D20-W20-L70-Z03	●	20	3	20	70	30	10			
AEM90-AD10T3-D20-W20-L100-Z03-H	●	20	3	20	100	30	10			
AEM90-AD10T3-D20-W20-L150-Z03	●	20	3	20	150	40	10			
AEM90-AD10T3-D20-C20-L150-Z03	●	20	3	20	150	40	10			
AEM90-AD10T3-D20-C20-L200-Z03	●	20	3	20	200	50	10			
AEM90-AD10T3-D25-W25-L100-Z03-H	●	25	3	25	100	30	10	ADMT 1204..	4010-M3x6	80-T10
AEM90-AD10T3-D25-W25-L100-Z04-H	●	25	4	25	100	30	10			
AEM90-AD10T3-D25-W25-L150-Z03	●	25	3	25	150	50	10			
AEM90-AD1204-D20-W20-L150-Z02	●	20	2	20	150	50	12			
AEM90-AD1204-D21-C20-L150-Z02	●	21	2	20	150	30	12			
AEM90-AD1204-D22-C20-L150-Z02	●	22	2	20	150	30	12	ADMT 1606..	4015-M4x9	80-T15
AEM90-AD1204-D25-W25-L150-Z03	●	25	3	25	150	50	12			
AEM90-AD1204-D26-W25-L180-Z03	●	26	3	25	180	30	12			
AEM90-AD1204-D32-W32-L150-Z04	●	32	4	32	150	50	12	ADMT 1606..	4015-M4x9	80-T15
AEM90-AD1606-D25-W25-L150-Z02	●	25	2	25	150	50	15			
AEM90-AD1606-D32-W32-L150-Z03	●	32	3	32	150	50	15			

R: Sağ / Right / Правый L: Sol / Left / Левый
● Stokta / In Stock / В наличии ○ Stokta Yok / Non Stock Item / Нет в наличии
WLTR Ucuna Uygunudur. / Compatible with WLTR Insert. / Под пластину WLTR.

Sipariş Örneği/Ordering Example/Образец заказа
1 ad./pcs./шт. AEM90-AD0803-D16-W16-L150-Z02
Kesme Hesabı : S 367 / Cutting Calculation : P 367 / Расчет режимов резания: стр. 367

S-SİSTEM YÜZEY PARMAK FREZELER

S-SYSTEM END MILLS

S-ТИП КОНЦЕВЫЕ ФРЕЗЫ

KAPR=90°

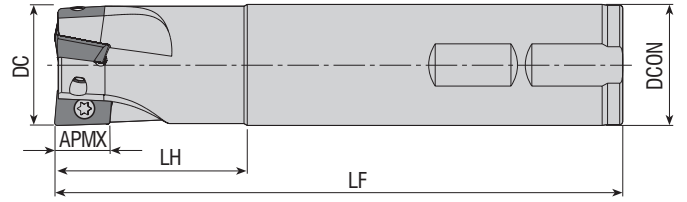

Takım Kodu Ordering Code Код для заказа	Stok Stock Наличие	Takım Ölçüleri (mm) Dimension (mm) Размеры (мм)						Kesici Uç Insert Пластина	Yedek Parçaları / Spare Parts / Запасные части		
		DC	ZEPF	DCON	LF	LH	APMX		Sıkma Vidası Screw Зажимной винт	Tork Anahtar Torx Key Торх Ключ	
AEM90-AD1003-D16-C16-L150-Z02	●	16	2	16	150	30	8	ADMT 1003..			
AEM90-AD1003-D17-C16-L150-Z02	●	17	2	16	150	25	8				
AEM90-AD1003-D20-C20-L200-Z03	●	20	3	20	200	50	8				
AEM90-AD1003-D21-C20-L150-Z03	●	21	3	20	150	25	8				
AEM90-AD1003-D21-C20-L200-Z03	●	21	3	20	200	25	8				
AEM90-AD1003-D25-C25-L200-Z03	●	25	3	25	200	50	8				
AEM90-AD1003-D26-C25-L150-Z03	●	26	3	25	150	30	8				
AEM90-AD1003-D26-C25-L200-Z03	●	26	3	25	200	30	8				
AEM90-AD1505D-D25-W25-L150-Z02	●	25	2	25	150	50	14.3	ADKT 1505..	4015-M4x9 4015-M4x11	80-T15	
AEM90-AD1505D-D32-W32-L150-Z03	●	32	3	32	150	50	14.3				

DJT Ucuna Uygundur. / Compatible with DJT Insert. / Под пластину SMTM-DJT

KAPR=90°

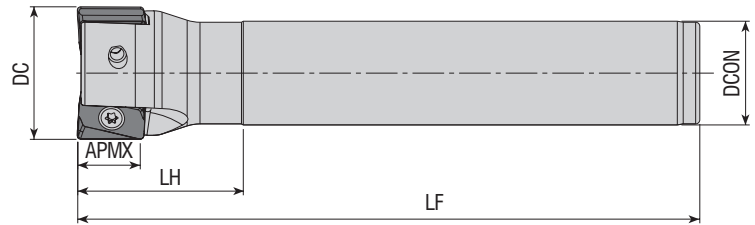

Takım Kodu Ordering Code Код для заказа	Stok Stock Наличие	Takım Ölçüleri (mm) Dimension (mm) Размеры (мм)						Kesici Uç Insert Пластина	Yedek Parçaları / Spare Parts / Запасные части		
		DC	ZEPF	DCON	LF	LH	APMX		Sıkma Vidası Screw Зажимной винт	Tork Anahtar Torx Key Торх Ключ	
AEM90-AN11-D22-W20-L150-Z02	●	22	2	20	150	30	11	ANGX 1105..			
AEM90-AN11-D25-W25-L150-Z02	●	25	2	25	150	40	11				
AEM90-AN11-D25-C25-L200-Z02	●	25	2	25	200	40	11				
AEM90-AN11-D26-W25-L150-Z02	●	26	2	25	150	40	11				
AEM90-AN11-D28-W25-L150-Z02	●	28	2	25	150	25	11				
AEM90-AN11-D32-W32-L150-Z03	●	32	3	32	150	50	11				
AEM90-AN11-D32-C32-L200-Z03	●	32	3	32	200	50	11				
AEM90-AN11-D40-W32-L150-Z04	●	40	4	32	150	40	11				

R: Sağ / Right / Правый L: Sol / Left / Левый

● Stokta / In Stock / В наличии ○ Stokta Yok / Non Stock Item / Нет в наличии
ZCC Ucuna Uygundur. / Compatible with ZCC Insert. / Под пластину ZCC

Sipariş Örneği/Ordering Example/Образец заказа

1 ad./pcs./шт. AEM90-AD1003-D16-C16-L150-Z02

Kesme Hesabı : S 367 / Cutting Calculation : P 367 / Расчет режимов резания: стр. 367



www.akko.com.tr

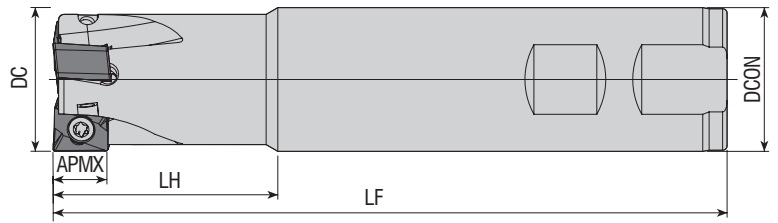

Takım Kodu Ordering Code Код для заказа	Stok Stock Наличие	Takım Ölçüleri (mm) Dimension (mm) Размеры (мм)						Kesici Uç Insert Пластина	Yedek Parçaları / Spare Parts / Запасные части		
		DC	ZEFP	DCON	LF	LH	APMX		Sıkma Vidası Screw Зажимной винт	Tork Anahtar Torx Key Торх Ключ	
AEM90-AN1207-D25-W25-L150-Z02	●	25	2	25	150	40	10	AN.KX 1207..		4015-M4x11	
AEM90-AN1207-D32-W32-L150-Z03	●	32	3	32	150	50	10				
AEM90-AN1207-D40-W32-L150-Z04	●	40	4	32	150	40	10				

XTC-GSC Ucuna Uygunudur. / Compatible with XTC-GSC Insert. / Под пластину XTC-GSC

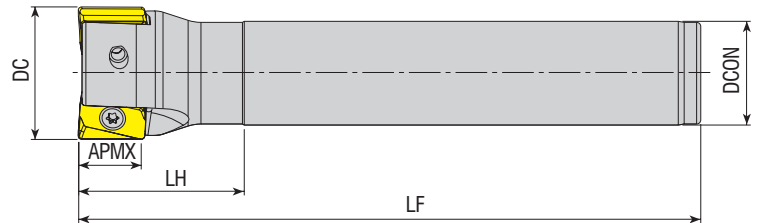

Takım Kodu Ordering Code Код для заказа	Stok Stock Наличие	Takım Ölçüleri (mm) Dimension (mm) Размеры (мм)						Kesici Uç Insert Пластина	Yedek Parçaları / Spare Parts / Запасные части		
		DC	ZEFP	DCON	LF	LH	APMX		Sıkma Vidası Screw Зажимной винт	Tork Anahtar Torx Key Торх Ключ	
AEM90-AN1607-D32-C25-L150-Z02	●	32	2	25	150	50	15	AN.X 1607..		4015-M4x11	
AEM90-AN1607-D40-C32-L150-Z03	●	40	3	32	150	50	15				

R: Sağ / Right / Правый L: Sol / Left / Левый

● Stokta / In Stock / В наличии ○ Stokta Yok / Non Stock Item / Нет в наличии
TGTC Ucuna Uygunudur. / Compatible with TGTC Insert. / Под пластину TGTC.

Sipariş Örneği/Ordering Example/Образец заказа
1 ad./pcs./шт. AEM90-AN1207-D25-W25-L150-Z02
Kesme Hesabı : S 367 / Cutting Calculation : P 367 / Расчет режимов резания: стр. 367

KAPR=90°

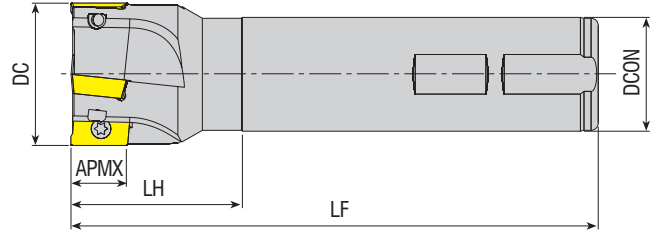

Takım Kodu Ordering Code Код для заказа	Stok Stock Наличие	Takım Ölçüleri (mm) Dimension (mm) Размеры (мм)						Kesici Uç Insert Пластина	Yedek Parçaları / Spare Parts / Запасные части		
		DC	ZEP	DCON	LF	LH	APMX		Sıkma Vidası Screw Зажимной винт	Tork Anahtar Torx Key Торх Ключ	
AEM90-AP06-D10-C10-L120-Z02	●	10	2	10	120	20	5.6	APMT 0602.. KRLY UCUNA UYGUNDUR. FOR KRLY INSERT. Под пластину KRLY	3006-M1.8x4	80-T06	
AEM90-AP06-D12-C12-L120-Z02	●	12	2	12	120	20	5.6				
AEM90-AP0903-D12-C16-L080-Z01-H	●	12	1	16	80	30	9	APMT 0903.. KRLY UCUNA UYGUNDUR. FOR KRLY INSERT. Под пластину KRLY	3008-M2.5x5		
AEM90-AP0903-D16-C16-L090-Z02	●	16	2	16	90	30	9				
AEM90-AP0903-D16-C16-L150-Z02	●	16	2	16	150	30	9				
AEM90-AP0903-D17-C16-L150-Z02	●	17	2	16	150	30	9				
AEM90-AP0903-D18-C16-L090-Z02-H	●	18	2	16	90	30	9				
AEM90-AP0903-D20-C20-L110-Z03	●	20	3	20	110	30	9				
AEM90-AP0903-D20-C20-L150-Z02	●	20	2	20	150	30	9				
AEM90-AP0903-D20-C20-L200-Z02	●	20	2	20	200	100	9				
AEM90-AP0903-D21-C20-L150-Z02	●	21	2	20	150	30	9				
AEM90-AP0903-D25-C25-L120-Z03	●	25	3	25	120	30	9				
AEM90-AP0903-D25-C25-L150-Z03	●	25	3	25	150	30	9				
AEM90-AP0903-D25-C25-L200-Z02	●	25	2	25	200	100	9				
AEM90-AP09-D16-C16-L100-Z02-H	●	16	2	16	100	30	8.8	APKT 09T3.. TGTC UCUNA UYGUNDUR. FOR TGTC INSERT. Под пластину TGTC	3008-M2.5x5	80-T08	
AEM90-AP09-D16-C15-L150-Z02	●	16	2	15	150	25	8.8				
AEM90-AP09-D16-W16-L150-Z02-H	●	16	2	16	150	25	8.8				
AEM90-AP09-D16-C16-L200-Z02-H	●	16	2	16	200	100	8.8				
AEM90-AP09-D17-C16-L150-Z02	●	17	2	16	150	25	8.8				
AEM90-AP09-D17-C16-L180-Z02-H	●	17	2	16	180	25	8.8				
AEM90-AP09-D20-C20-L150-Z03-H	●	20	3	20	150	50	8.8				
AEM90-AP09-D20-C20-L200-Z03-H	●	20	3	20	200	100	8.8				
AEM90-AP09-D20-C20-L250-Z02-H	●	20	2	20	250	150	8.8				
AEM90-AP09-D21-C20-L150-Z03	●	21	3	20	150	25	8.8				
AEM90-AP09-D26-C25-L150-Z04	●	26	4	25	150	30	8.8				
AEM90-AP10-D10-C10-L100-Z01	●	10	1	10	100	20	10	AP. 1003.. ISO UCUNA UYGUNDUR. FOR ISO INSERT. Под пластину ISO	3008-M2.5x5		
AEM90-AP10-D12-C16-L100-Z01-H	●	12	1	16	100	30	10				
AEM90-AP10-D12-W16-L100-Z01-H	●	12	1	16	100	30	10				
AEM90-AP10-D12-W16-L150-Z01	●	12	1	16	150	38	10				
AEM90-AP10-D14-W16-L100-Z01-H	●	14	1	16	100	30	10				
AEM90-AP10-D14-W16-L150-Z01	●	14	1	16	150	38	10				
AEM90-AP10-D16-C16-L100-Z02-H	●	16	2	16	100	30	10				
AEM90-AP10-D16-W16-L100-Z02-H	●	16	2	16	100	30	10				
AEM90-AP10-D16-W16-L200-Z02	●	16	2	16	200	100	10				
AEM90-AP10-D16-C16-L120-Z02-H	●	16	2	16	120	30	10				

R: Sağ / Right / Правый L: Sol / Left / Левый



● Stokta / In Stock / В наличии ○ Stokta Yok / Non Stock Item / Нет в наличии

Sipariş Örneği/Ordering Example/Образец заказа

1 ad./pcs./шт. AEM90-AP06-D10-C10-L120-Z02

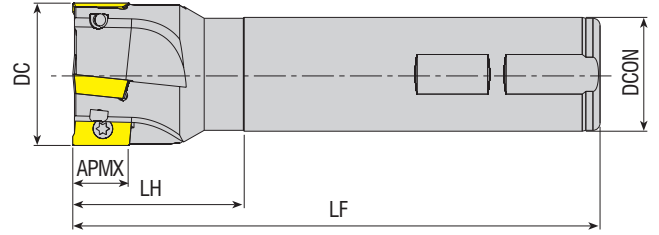
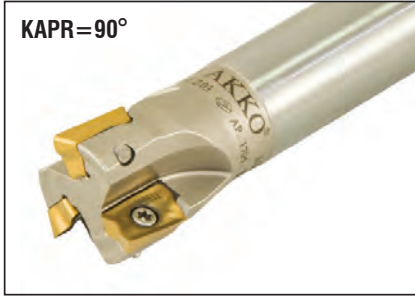
Kesme Hesabı : S 367 / Cutting Calculation : P 367 / Расчет режимов резания: стр. 367



Takım Kodu Ordering Code Код для заказа	Stok Stock Наличие	Takım Ölçüleri (mm) Dimension (mm) Размеры (мм)						Kesici Uç Insert Пластина	Yedek Parçaları / Spare Parts / Запасные части		
		DC	ZEFP	DCON	LF	LH	APMX		Sıkma Vidası Screw Зажимной винт	Tork Anahtar Torx Key Торх Ключ	
AEM90-AP10-D16-C16-L150-Z02	●	16	2	16	150	50	10	 AP. 1003.. ISO UCUNA UYGUNDUR. FOR ISO INSERT. <i>Под пластину ISO</i>	 3008-M2.5x5	 80-T08	
AEM90-AP10-D16-C16-L150-Z02-H	●	16	2	16	150	50	10				
AEM90-AP10-D16-W16-L150-Z02	●	16	2	16	150	50	10				
AEM90-AP10-D16-C16-L200-Z02	●	16	2	16	200	100	10				
AEM90-AP10-D16-C16-L200-Z02-H	●	16	2	16	200	100	10				
AEM90-AP10-D16-C16-L250-Z02	●	16	2	16	250	150	10				
AEM90-AP10-D18-W16-L100-Z02-H	●	18	2	16	100	30	10				
AEM90-AP10-D18-W16-L150-Z02	●	18	2	16	150	30	10				
AEM90-AP10-D20-C20-L100-Z03-H	●	20	3	20	100	30	10				
AEM90-AP10-D20-W20-L100-Z03-H	●	20	3	20	100	30	10				
AEM90-AP10-D20-C20-L120-Z03-H	●	20	3	20	120	30	10				
AEM90-AP10-D20-C20-L150-Z03	●	20	3	20	150	50	10				
AEM90-AP10-D20-C20-L150-Z03-H	●	20	3	20	150	50	10				
AEM90-AP10-D20-W20-L150-Z03	●	20	3	20	150	50	10				
AEM90-AP10-D20-C20-L200-Z02	●	20	2	20	200	100	10				
AEM90-AP10-D20-C20-L200-Z03-H	●	20	3	20	200	100	10				
AEM90-AP10-D20-C20-L250-Z02	●	20	2	20	250	150	10				
AEM90-AP10-D20-C20-L250-Z02-H	●	20	2	20	250	150	10				
AEM90-AP10-D21-C20-L200-Z03	●	21	3	20	200	30	10				
AEM90-AP10-D21-W20-L150-Z03	●	21	3	20	150	30	10				
AEM90-AP10-D22-W20-L100-Z03-H	●	22	3	20	100	30	10				
AEM90-AP10-D22-W20-L150-Z03	●	22	3	20	150	30	10				
AEM90-AP10-D23-W20-L150-Z03	●	23	3	20	150	30	10				
AEM90-AP10-D24-W20-L150-Z03	●	24	3	20	150	30	10				
AEM90-AP10-D25-W25-L100-Z04-H	●	25	4	25	100	30	10				
AEM90-AP10-D25-C25-L100-Z03-H	●	25	3	25	100	30	10				
AEM90-AP10-D25-W25-L100-Z03-H	●	25	3	25	100	30	10				
AEM90-AP10-D25-C25-L120-Z03-H	●	25	3	25	120	30	10				
AEM90-AP10-D25-C25-L150-Z03	●	25	3	25	150	50	10				
AEM90-AP10-D25-W25-L150-Z03	●	25	3	25	150	50	10				
AEM90-AP10-D25-C25-L200-Z02	●	25	2	25	200	100	10				
AEM90-AP10-D25-C25-L200-Z03	●	25	3	25	200	100	10				
AEM90-AP10-D25-C25-L250-Z02	●	25	2	25	250	100	10				

R: Sağ / Right / Правый L: Sol / Left / Левый

● Stokta / In Stock / В наличии ○ Stokta Yok / Non Stock Item / Нет в наличии

Sipariş Örneği/Ordering Example/Образец заказа

1 ad./pcs./шт. AEM90-AP10-D16-C16-L150-Z02

Kesme Hesabı : S 367 / Cutting Calculation : P 367 / Расчет режимов резания: стр. 367

KAPR=90°

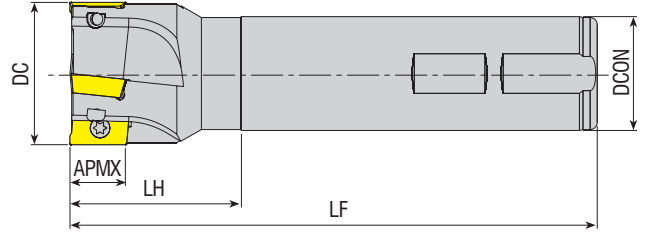
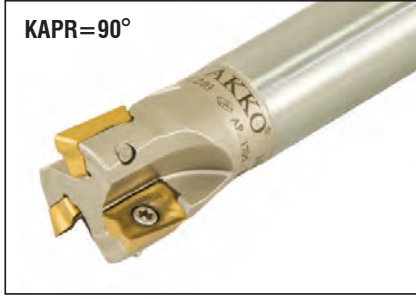

Takım Kodu
Ordering Code
Код для заказа

Stok
Stock
Наличие

Takım Ölçüleri (mm)
Dimension (mm)
Размеры (мм)

Kesici Uç
Insert
Пластина

Yedek Parçaları / Spare Parts / Запасные части

Sikma Vidası
Screw
Зажимной винт

Tork Anahtar
Torx Key
Торх Ключ

Takım Kodu Ordering Code Код для заказа	Stok Stock Наличие	DC	ZEPF	DCON	LF	LH	APMX	Kesici Uç Insert Пластина	Sikma Vidası Screw Зажимной винт	Tork Anahtar Torx Key Торх Ключ
AEM90-AP10-D30-C25-L100-Z04-H	●	30	4	25	100	30	10	AP. 1003.. ISO UCUNA UYGUNDUR. FOR ISO INSERT. Под пластину ISO	3008-M2.5x6	
AEM90-AP10-D30-C25-L120-Z04-H	●	30	4	25	120	30	10			
AEM90-AP10-D30-C25-L150-Z04	●	30	4	25	150	30	10			
AEM90-AP10-D32-C25-L100-Z04-H	●	32	4	25	100	35	10			
AEM90-AP10-D32-C25-L120-Z04-H	●	32	4	25	120	35	10			
AEM90-AP10-D32-C25-L150-Z04	●	32	4	25	150	35	10			
AEM90-AP10-D32-W25-L150-Z04	●	32	4	25	150	35	10			
AEM90-AP10-D32-C32-L130-Z05	●	32	5	32	130	30	10			
AEM90-AP10-D32-W32-L150-Z04	●	32	4	32	150	50	10			
AEM90-AP10-D40-W32-L150-Z05	●	40	5	32	150	40	10			
AEM90-AP10D-D16-W16-L150-Z02	●	16	2	16	150	50	10	AP. 1003.. DJT UCUNA UYGUNDUR. FOR DJT INSERT/ Под пластину DJT	3008-M2.5x5	80-T08
AEM90-AP10D-D20-W20-L150-Z03	●	20	3	20	150	50	10			
AEM90-AP10D-D25-W20-L150-Z03	●	25	3	20	150	30	10			
AEM90-AP100-D16-C15-L150-Z02	●	16	2	15	150	30	10	AP. 1003.. B.ÖKE UCUNA UYGUNDUR. FOR B.ÖKE INSERT Под пластину B.ÖKE	3008-M2.5x5	80-T08
AEM90-AP100-D21-C20-L150-Z03	●	21	3	20	150	30	10			
AEM90-AP100-D26-C25-L150-Z04	●	26	4	25	150	35	10			
AEM90-AP100-D33-C32-L200-Z05	●	33	5	32	200	50	10	AP. 1003.. SMTM UCUNA UYGUNDUR. FOR SMTM INSERT Под пластину SMTM	3008-M2.5x6	80-T08
AEM90-AP10S-D16-W16-L150-Z02	●	16	2	16	150	26	10			
AEM90-AP10S-D20-W20-L150-Z02	●	20	2	20	150	26	10			
AEM90-AP10S-D25-W25-L150-Z03	●	25	3	25	150	26	10	AP. 11T3.. ZCC UCUNA UYGUNDUR. FOR ZCC INSERT. Под пластину ZCC	3008-M2.5x6	80-T08
AEM90-AP11-D16-C16-L150-Z02	●	16	2	16	150	50	11			
AEM90-AP11-D16-C16-L150-Z02-H	●	16	2	16	150	50	11			
AEM90-AP11-D16-W16-L150-Z02	●	16	2	16	150	50	11			
AEM90-AP11-D16-W16-L150-Z02-H	●	16	2	16	150	50	11			
AEM90-AP11-D16-C16-L200-Z02	●	16	2	16	200	100	11			
AEM90-AP11-D17-C16-L150-Z02	●	17	2	16	150	30	11			
AEM90-AP11-D17-C16-L200-Z02	●	17	2	16	200	30	11			
AEM90-AP11-D20-C20-L150-Z03	●	20	3	20	150	50	11			
AEM90-AP11-D20-W20-L150-Z03	●	20	3	20	150	50	11			
AEM90-AP11-D20-W20-L150-Z03-H	●	20	3	20	150	50	11			
AEM90-AP11-D20-C20-L200-Z03	●	20	3	20	200	100	11			
AEM90-AP11-D21-C20-L150-Z03	●	21	3	20	150	30	11			
AEM90-AP11-D21-W20-L150-Z03	●	21	3	20	150	30	11			
AEM90-AP11-D21-W20-L150-Z03-H	●	21	3	20	150	30	11			
AEM90-AP11-D21-C20-L200-Z03	●	21	3	20	200	30	11			
AEM90-AP11-D25-C25-L150-Z03	●	25	3	25	150	50	11			
AEM90-AP11-D25-W25-L150-Z03	●	25	3	25	150	50	11			
AEM90-AP11-D25-W25-L150-Z03-H	●	25	3	25	150	50	11			
AEM90-AP11-D26-C25-L150-Z03	●	26	3	25	150	35	11			
AEM90-AP11-D26-C24-L150-Z03	●	26	3	24	150	35	11			
AEM90-AP11-D32-W25-L150-Z04	●	32	4	25	150	35	11			
AEM90-AP11-D32-W32-L150-Z03-H	●	32	3	32	150	50	11			
AEM90-AP11-D32-W32-L150-Z04	●	32	4	32	150	50	11			

R: Sağ / Right / Rechts L: Sol/Left/Links / ● Stokta / In Stock / В наличии ○ Stokta Yok / Non Stock Item / Нет в наличии





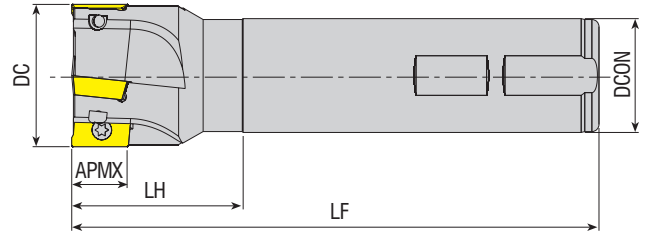
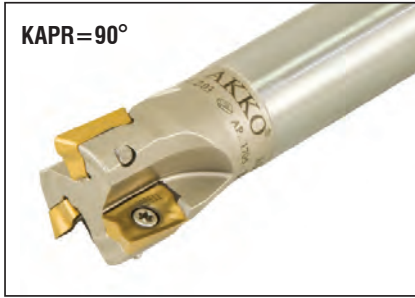

Sipariş Örneği/Ordering Example/Образец заказа

1 ad./pcs./шт. AEM90-AP10-D30-C25-L100-Z04-H

Kesme Hesabı : S 367 / Cutting Calculation : P 367 / Расчет режимов резания: стр. 367





Takım Kodu Ordering Code Код для заказа	Stok Stock Наличие	Takım Ölçüleri (mm) Dimension (mm) Размеры (мм)						Kesici Uç Insert Пластина	Yedek Parçaları / Spare Parts / Запасные части			
		DC	ZEPF	DCON	LF	LH	APMX		Sıkma Vidası Screw Зажимной винт	Tork Anahtar Torx Key Торх Ключ		
AEM90-AP1135A-D14-C16-L150-Z01	●	14	1	16	150	40	9.5	 APMT 1135.. ACHTK UCUNA UYGUNDUR. FOR ACHTK INSERT. Под пластину ACHTK	3008-M2.5x5	 80-T08		
AEM90-AP1135A-D16-C16-L150-Z02	●	16	2	16	150	40	9.5					
AEM90-AP1135A-D16-C16-L200-Z02	●	16	2	16	200	100	9.5					
AEM90-AP1135A-D16-C16-L250-Z02	●	16	2	16	250	150	9.5					
AEM90-AP1135A-D17-C16-L180-Z02	●	17	2	16	180	30	9.5					
AEM90-AP1135A-D20-C20-L150-Z03	●	20	3	20	150	50	9.5					
AEM90-AP1135A-D20-C20-L200-Z02	●	20	2	20	200	100	9.5					
AEM90-AP1135A-D21-C20-L180-Z02	●	21	2	20	180	30	9.5					
AEM90-AP1135A-D25-C25-L200-Z03	●	25	3	25	200	100	9.5					
AEM90-AP1135A-D26-C25-L250-Z02	●	26	2	25	250	35	9.5					
AEM90-AP1135A-D33-C32-L250-Z02	●	33	2	32	250	35	9.5					
AEM90-AP110-D16-C15-L150-Z02	●	16	2	15	150	30	11	 AP. 1135.. B.ÖKE UCUNA UYGUNDUR. FOR B.ÖKE INSERT Под пластину B.ÖKE	3008-M2.5x5	80-T08		
AEM90-AP110-D21-C20-L150-Z03	●	21	3	20	150	30	11					
AEM90-AP110-D26-C25-L150-Z04	●	26	4	25	150	35	11					
AEM90-AP110-D33-C32-L200-Z05	●	33	5	32	200	50	11					
AEM90-APK11G-D16-W16-L150-Z02	●	16	2	16	150	26	11					
AEM90-APK11G-D20-W20-L150-Z03	●	20	3	20	150	26	11	 APKT 1135.. XTC-GSC UCUNA UYGUNDUR. FOR XTC-GSC INSERT Под пластину XTC-GSC	3008-M3x5			
AEM90-APK11G-D25-W25-L150-Z03	●	25	3	25	150	26	11					
AEM90-AP1135-D16-W16-L110-Z02-H	●	16	2	16	110	30	9.5					
AEM90-AP1135-D16-W16-L150-Z02	●	16	2	16	150	50	9.5	 AP. 1135.. XTC-GSC UCUNA UYGUNDUR. FOR XTC-GSC INSERT. Под пластину XTC-GSC	3008-M2.5x6			
AEM90-AP1135-D20-W20-L125-Z03-H	●	20	3	20	125	30	9.5					
AEM90-AP1135-D20-W20-L150-Z03	●	20	3	20	150	50	9.5					
AEM90-AP1135-D25-W25-L125-Z04-H	●	25	4	25	125	30	9.5					
AEM90-AP1135-D25-W25-L200-Z04-H	●	25	4	25	200	100	9.5					
AEM90-AP1135-D32-W32-L125-Z05-H	●	32	5	32	125	30	9.5					
AEM90-AP1135-D32-W32-L200-Z04-H	●	32	4	32	200	100	9.5					
AEM90-AP1135Y-D16-C16-L120-Z02-H	●	16	2	16	120	30	9.5					
AEM90-AP1135Y-D16-W16-L150-Z02	●	16	2	16	150	50	9.5					
AEM90-AP1135Y-D17-C16-L150-Z02	●	17	2	16	150	30	9.5					
AEM90-AP1135Y-D20-C20-L120-Z02	●	20	2	20	120	30	9.5	 APMT 1135.. YG UCUNA UYGUNDUR. FOR YG INSERT. Под пластину YG	3008-M2.5x6			
AEM90-AP1135Y-D20-W20-L150-Z03	●	20	3	20	150	50	9.5					
AEM90-AP1135Y-D21-C20-L150-Z03	●	21	3	20	150	30	9.5					
AEM90-AP1135Y-D25-W25-L150-Z03	●	25	3	25	150	50	9.5					
AEM90-AP1135Y-D25-C25-L150-Z04-H	●	25	4	25	150	30	9.5					
AEM90-AP1135Y-D26-C25-L150-Z03	●	26	3	25	150	35	9.5					
AEM90-AP1135Y-D32-W25-L110-Z04	●	32	4	25	110	35	9.5					
AEM90-AP1204-D20-C20-L150-Z02	●	20	2	20	150	30	12			 AP. 1204.. TGTC UCUNA UYGUNDUR. FOR TGTC INSERT. Под пластину TGTC	3010-M3.5x7	80-T10
AEM90-AP1204-D21-C20-L150-Z02	●	21	2	20	150	30	12					
AEM90-AP1204-D21-C20-L200-Z02	●	21	2	20	200	30	12					
AEM90-AP1204-D25-C25-L150-Z03	●	25	3	25	150	40	12					
AEM90-AP1204-D26-C25-L250-Z02	●	26	2	25	250	35	12					
AEM90-AP1204-D32-C25-L150-Z03	●	32	3	25	150	35	12					

R: Sağ / Right / Правый L: Sol / Left / Левый

● Stokta / In Stock / В наличии ○ Stokta Yok / Non Stock Item / Нет в наличии

Sipariş Örneği/Ordering Example/Образец заказа

1 ad./pcs./шт. AEM90-AP1135A-D14-C16-L150-Z01

Kesme Hesabı : S 367 / Cutting Calculation : P 367 / Расчет режимов резания: стр. 367

KAPR=90°

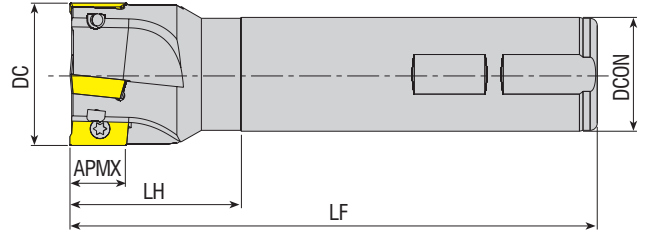
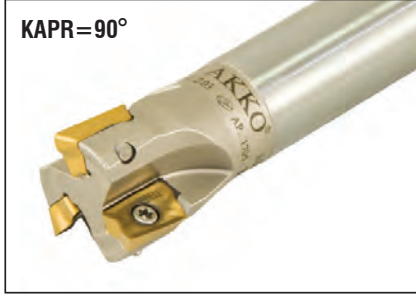
Takım Kodu
Ordering Code
 Код для заказа

 Stok
 Stock
 Наличие







 Takım Ölçüleri (mm)
 Dimension (mm)
 Размеры (мм)

 Kesici Uç
 Insert
 Пластина

Yedek Parçaları / Spare Parts / Запасные части

 Sıkma Vidası
 Screw
 Зажимной винт

 Tork Anahtar
 Torx Key
 Торх Ключ

	DC	ZEP	DCON	LF	LH	APMX							
AEM90-AP16-D25-C20-L100-Z02	●	25	2	20	100	35	16	AP. 1604.. ISO UCUNA UYGUNDUR. <i>FOR ISO INSERT</i> <i>Под пластину ISO</i>	 4015-M4x9	 80-T15			
AEM90-AP16-D25-W25-L100-Z02-H	●	25	2	25	100	35	16						
AEM90-AP16-D25-W25-L150-Z02	●	25	2	25	150	50	16						
AEM90-AP16-D25-C25-L250-Z02	●	25	2	25	250	100	16						
AEM90-AP16-D28-W25-L100-Z03-H	●	28	3	25	100	40	16						
AEM90-AP16-D28-W25-L150-Z03	●	28	3	25	150	40	16						
AEM90-AP16-D30-W25-L110-Z03-H	●	30	3	25	110	40	16						
AEM90-AP16-D30-W25-L150-Z02	●	30	2	25	150	40	16						
AEM90-AP16-D30-W25-L150-Z03	●	30	3	25	150	40	16						
AEM90-AP16-D32-W32-L110-Z03-H	●	32	3	32	110	40	16						
AEM90-AP16-D32-C32-L150-Z03	●	32	3	32	150	50	16						
AEM90-AP16-D32-W25-L150-Z03	●	32	3	25	150	40	16						
AEM90-AP16-D32-W32-L150-Z03	●	32	3	32	150	50	16						
AEM90-AP16-D32-W32-L150-Z03-H	●	32	3	32	150	50	16						
AEM90-AP16-D32-C25-L200-Z03-H	●	32	3	25	200	40	16						
AEM90-AP16-D32-C32-L250-Z02	●	32	2	32	250	100	16						
AEM90-AP16-D32-C32-L250-Z03	●	32	3	32	250	100	16						
AEM90-AP16-D35-W32-L150-Z03	●	35	3	32	150	40	16						
AEM90-AP16-D36-W32-L110-Z03-H	●	36	3	32	110	40	16						
AEM90-AP16-D36-W32-L150-Z03	●	36	3	32	150	40	16						
AEM90-AP16-D40-W32-L110-Z04-H	●	40	4	32	110	40	16						
AEM90-AP16-D40-C32-L150-Z04	●	40	4	32	150	40	16						
AEM90-AP16-D40-W32-L150-Z04	●	40	4	32	150	40	16						
AEM90-AP16-D40-C32-L250-Z02	●	40	2	32	250	40	16						
AEM90-AP16-D40-C32-L250-Z04	●	40	4	32	250	40	16						
AEM90-AP16DJ-D25-W25-L150-Z02	●	25	2	25	150	50	16	AP. 1604.. DJT UCUNA UYGUNDUR. <i>FOR DJT INSERT.</i> <i>Под пластину DJT</i>	 4015-M4x9	 80-T15			
AEM90-AP16DJ-D25-C25-L200-Z02	●	25	2	25	200	50	16						
AEM90-AP16DJ-D32-W32-L150-Z03	●	32	3	32	150	50	16						
AEM90-AP16DJ-D32-C32-L180-Z03	●	32	3	32	180	50	16						
AEM90-AP16DJ-D32-C32-L200-Z03	●	32	3	32	200	50	16						
AEM90-AP16L-D25-C25-L120-Z02-H	●	25	2	25	120	45	16				AP. 1604.. LMN UCUNA UYGUNDUR. <i>FOR LMN INSERT.</i> <i>Под пластину LMN</i>	 4015-M4x9	 80-T15
AEM90-AP16L-D25-C25-L150-Z02	●	25	2	25	150	55	16						
AEM90-AP16L-D25-C25-L200-Z02	●	25	2	25	200	55	16						
AEM90-AP16L-D25-C25-L250-Z02	●	25	2	25	250	100	16						
AEM90-AP16L-D30-W25-L120-Z03-H	●	30	3	25	120	40	16						
AEM90-AP16L-D32-C32-L120-Z03-H	●	32	3	32	120	45	16						
AEM90-AP16L-D32-C32-L150-Z03	●	32	3	32	150	55	16						
AEM90-AP16L-D32-C32-L200-Z03	●	32	3	32	200	55	16						
AEM90-AP16L-D32-C32-L250-Z03	●	32	3	32	250	100	16						
AEM90-AP16L-D40-C32-L120-Z04-H	●	40	4	32	120	40	16						
AEM90-AP16L-D40-C32-L150-Z04	●	40	4	32	150	40	16						
AEM90-AP16L-D40-C32-L200-Z04	●	40	4	32	200	40	16						
AEM90-AP16L-D40-C32-L250-Z04	●	40	4	32	250	40	16						

R: Sağ / Right / Правый L: Sol / Left / Левый

● Stokta / In Stock / В наличии ○ Stokta Yok / Non Stock Item / Нет в наличии

Sipariş Örneği/Ordering Example/Образец заказа

1 ad./pcs./шт. AEM90-AP16-D25-C20-L100-Z02

Kesme Hesabı : S 367 / Cutting Calculation : P 367 / Расчет режимов резания: стр. 367

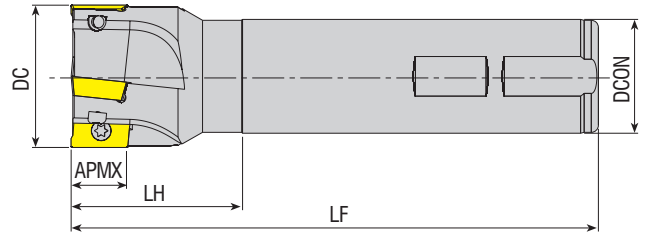
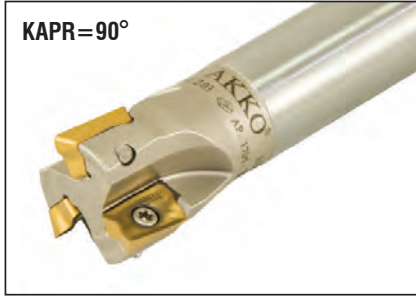

Takım Kodu Ordering Code Код для заказа	Stok Stock Наличие	Takım Ölçüleri (mm) Dimension (mm) Размеры (мм)						Kesici Uç Insert Пластина	Yedek Parçaları / Spare Parts / Запасные части		
		DC	ZEFP	DCON	LF	LH	APMX		Sıkma Vidası Screw Зажимной винт	Tork Anahtar Torx Key Торх Ключ	
AEM90-AP16P-D25-W25-L100-Z02-H	●	25	2	25	100	35	16	AP. 1604.. PLBT UCUNA UYGUNDUR. FOR PLBT INSERT. Под пластину PLBT	4015-M4x9	80-T15	
AEM90-AP16P-D25-W25-L150-Z02	●	25	2	25	150	50	16				
AEM90-AP16P-D32-W32-L150-Z03	●	32	3	32	150	50	16				
AEM90-AP16P-D32-C32-L250-Z02	●	32	2	32	250	100	16				
AEM90-AP16P-D40-W32-L150-Z04	●	40	4	32	150	50	16				
AEM90-AP16Y-D25-C20-L100-Z02-H	●	25	2	20	100	35	16	AP. 1604.. YG UCUNA UYGUNDUR. FOR YG INSERT. Под пластину YG	4015-M4x9	80-T15	
AEM90-AP16Y-D25-C25-L120-Z02	●	25	2	25	120	50	16				
AEM90-AP16Y-D25-C25-L150-Z02	●	25	2	25	150	50	16				
AEM90-AP16Y-D25-C25-L250-Z02	●	25	2	25	250	100	16	AP. 1705.. TGTC-LMN UCUNA UYGUNDUR. FOR TGTC-LMN INSERT. Под пластину TGTC-LMN	4015-M4x9	80-T15	
AEM90-AP1705-D25-C25-L120-Z02	●	25	2	25	120	40	16				
AEM90-AP1705-D26-C25-L200-Z02	●	26	2	25	200	40	16				
AEM90-AP1705-D26-C25-L250-Z02	●	26	2	25	250	40	16				
AEM90-AP1705-D26-C25-L300-Z02	○	26	2	25	300	40	16				
AEM90-AP1705-D28-W25-L075-Z02	●	28	2	25	75	20	16				
AEM90-AP1705-D32-C25-L150-Z03	●	32	3	25	150	40	16				
AEM90-AP1705-D33-C32-L250-Z03	●	33	3	32	250	40	16				
AEM90-AP1705-D33-C32-L300-Z02	●	33	2	32	300	40	16				

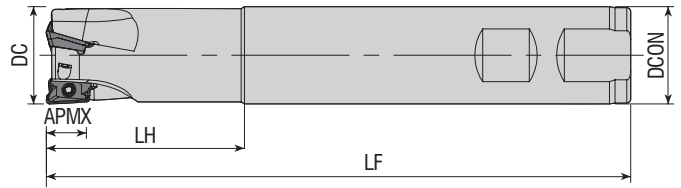

Takım Kodu Ordering Code Код для заказа	Stok Stock Наличие	Takım Ölçüleri (mm) Dimension (mm) Размеры (мм)						Kesici Uç Insert Пластина	Yedek Parçaları / Spare Parts / Запасные части		
		DC	ZEFP	DCON	LF	LH	APMX		Sıkma Vidası Screw Зажимной винт	Tork Anahtar Torx Key Торх Ключ	
AEM90-AO1236-D16-W16-L150-Z02	●	16	2	16	150	50	10	AO..1236..	3008-M2.5x6	80-T08	
AEM90-AO1236-D20-C20-L100-Z02	○	20	2	20	100	30	10				
AEM90-AO1236-D25-C25-L115-Z02	○	25	2	25	150	50	10				
AEM90-AO1236-D25-W25-L150-Z03	●	25	3	25	150	50	10				
AEM90-AO1236-D32-W32-L150-Z04	●	32	4	32	150	50	10				

R: Sağ / Right / Правый L: Sol / Left / Левый

● Stokta / In Stock / В наличии ○ Stokta Yok / Non Stock Item / Нет в наличии
MTSBH Ucuna Uygunudur. / Compatible with MTSBH Insert. / Под пластину MTSBH.

Sipariş Örneği/Ordering Example/Образец заказа
1 ad./pcs./шт. AEM90-AP16P-D25-W25-L100-Z02-H
Kesme Hesabı : S 367 / Cutting Calculation : P 367 / Расчет режимов резания: стр. 367

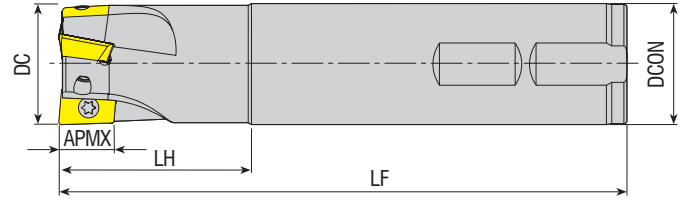

Takım Kodu Ordering Code Код для заказа	Stok Stock Наличие	Takım Ölçüleri (mm) Dimension (mm) Размеры (мм)						Kesici Uç Insert Пластина	Yedek Parçaları / Spare Parts / Запасные части	
		DC	ZEPF	DCON	LF	LH	APMX		Sıkma Vidası Screw Зажимной винт	Tork Anahtar Torx Key Торх Ключ
AEM90-AX0602-D10-C09-L120-Z02	●	10	2	9	120	20	5.7	AX.. 0602	3006-M1.8x4	80-T06
AEM90-AX0602-D10-C10-L080-Z02	●	10	2	10	80	20	5.7			
AEM90-AX0602-D10-C10-L120-Z02	●	10	2	10	120	20	5.7			
AEM90-AX0602-D12-C11-L120-Z02	●	12	2	11	120	20	5.7			
AEM90-AX0602-D12-C12-L080-Z02	●	12	2	12	80	20	5.7			
AEM90-AX0602-D12-C12-L120-Z02	●	12	2	12	120	20	5.7			
AEM90-AX0602-D14-C12-L120-Z03	●	14	3	12	120	20	5.7			
AEM90-AX0602-D16-W16-L120-Z04-H	●	16	4	16	120	20	5.7			
AEM90-AX0602-D16-W16-L150-Z04-H	●	16	4	16	150	20	5.7			
AEM90-AX0602-D20-W20-L120-Z05-H	●	20	5	20	120	25	5.7			
AEM90-AX0602-D20-W20-L150-Z05-H	●	20	5	20	150	25	5.7			
AEM90-AX0903-D16-C16-L120-Z02	●	16	2	16	120	30	8.8			
AEM90-AX0903-D16-C16-L180-Z02	●	16	2	16	180	30	8.8			
AEM90-AX0903-D17-C16-L120-Z02	●	17	2	16	120	25	8.8			
AEM90-AX0903-D17-C16-L180-Z02	●	17	2	16	180	25	8.8			
AEM90-AX0903-D20-C20-L120-Z03	●	20	3	20	120	30	8.8			
AEM90-AX0903-D20-C20-L200-Z02	●	20	2	20	200	30	8.8			
AEM90-AX0903-D21-C20-L120-Z03	●	21	3	20	120	25	8.8			
AEM90-AX0903-D21-C20-L200-Z02	●	21	2	20	200	25	8.8			
AEM90-AX0903-D25-C25-L150-Z03	●	25	3	25	150	30	8.8			
AEM90-AX0903-D25-C25-L250-Z02	●	25	2	25	250	40	8.8			
AEM90-AX0903-D26-C25-L150-Z03	●	26	3	25	150	30	8.8			

R: Sağ / Right / Правый L: Sol / Left / Левый
● Stokta / In Stock / В наличии ○ Stokta Yok / Non Stock Item / Нет в наличии
TGTC Ucuna Uygunudur. / Compatible with TGTC Insert. / Под пластину TGTC.

Sipariş Örneği/Ordering Example/Образец заказа
1 ad./pcs./шт. AEM90-AX0602-D10-C09-L120-Z02
Kesme Hesabı : S 367 / Cutting Calculation : P 367 / Расчет режимов резания: стр. 367

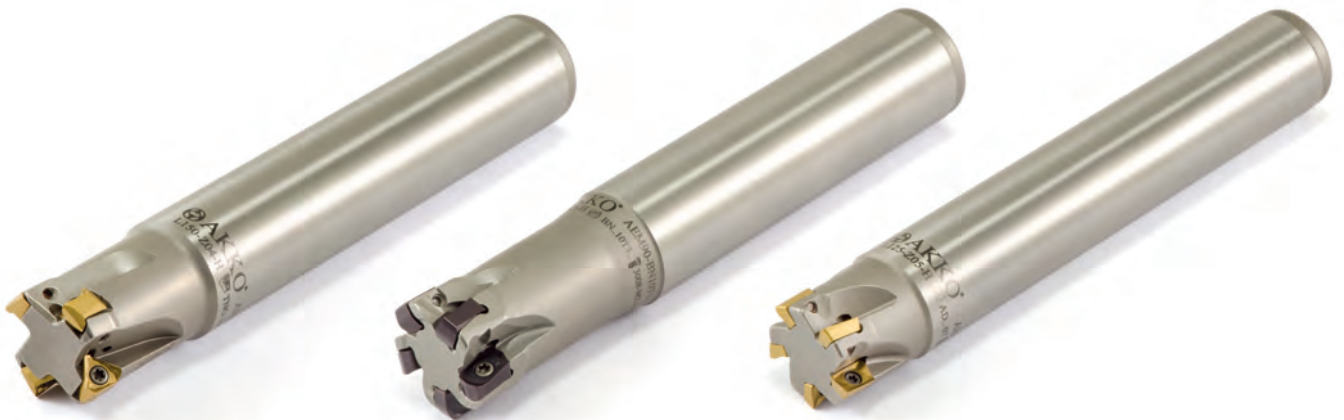

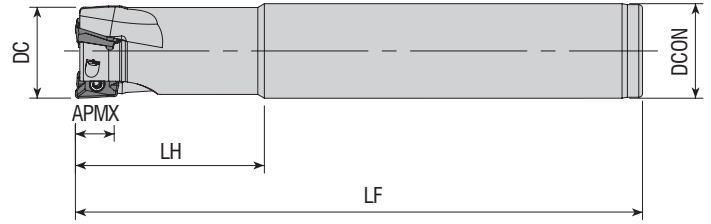

Takım Kodu
Ordering Code
Код для заказа

Stok
Stock
Наличие

Takım Ölçüleri (mm)
Dimension (mm)
Размеры (мм)

Kesici Uç
Insert
Пластина

Yedek Parçaları / Spare Parts / Запасные части

Sıkma Vidası
Screw
Зажимной винт

Tork Anahtar
Torx Key
Торх Ключ

DC ZEP DCON LF LH APMX

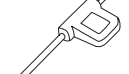

AEM90-AX1235-D16-C14-L120-Z02-H	●
AEM90-AX1235-D16-C15-L145-Z02-H	●
AEM90-AX1235-D16-C16-L100-Z02-H	●
AEM90-AX1235-D16-C16-L140-Z02-H	●
AEM90-AX1235-D16-C16-L145-Z02-H	●
AEM90-AX1235-D16-C16-L150-Z02	●
AEM90-AX1235-D20-C19-L150-Z02-H	●
AEM90-AX1235-D20-C20-L110-Z03-H	●
AEM90-AX1235-D20-C20-L150-Z02	●
AEM90-AX1235-D20-C20-L150-Z02-H	●
AEM90-AX1235-D20-C20-L150-Z03	●
AEM90-AX1235-D25-C20-L120-Z04-H	●
AEM90-AX1235-D25-C20-L150-Z04-H	●
AEM90-AX1235-D25-C24-L170-Z02-H	●
AEM90-AX1235-D25-C25-L120-Z04-H	●
AEM90-AX1235-D25-C25-L150-Z03	●
AEM90-AX1235-D25-C25-L170-Z02-H	●
AEM90-AX1235-D25-W25-L100-Z04-H	●
AEM90-AX1235-D32-C32-L130-Z05-H	●
AEM90-AX1235-D32-C32-L180-Z02-H	●
AEM90-AX1705-D25-C25-L150-Z02	●
AEM90-AX1705-D28-W25-L115-Z02-H	●
AEM90-AX1705-D32-C32-L150-Z03	●
AEM90-AX1705-D32-C32-L180-Z02-H	●

AX.T 1235..

AX.T 1705..

3008-M3x6
3108-M3x6
3008-M3x6
3108-M3x6
3008-M3x6
3108-M3x6
3008-M3x6
3108-M3x6
3008-M3x6
3108-M3x6
3008-M3x6
3108-M3x6
3008-M3x6
3108-M3x6
3008-M3x6
3108-M3x6

80-T08

80-T15

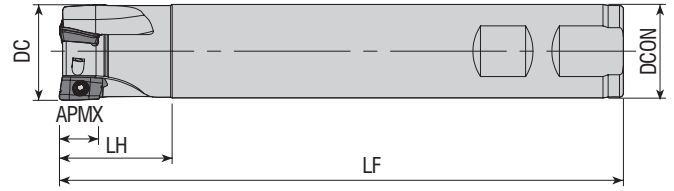

Takım Kodu Ordering Code Код для заказа	Stok Stock Наличие	Takım Ölçüleri (mm) Dimension (mm) Размеры (мм)						Kesici Uç Insert Пластина	Yedek Parçaları / Spare Parts / Запасные части		
		DC	ZEFP	DCON	LF	LH	APMX		Sıkma Vidası Screw Зажимной винт	Tork Anahtar Torx Key Торх Ключ	
AEM90-AZ11-D12-W16-L90-Z01	●	12	1	16	90	30	11	AZGT 1135..	3008-M2.5X5		
AEM90-AZ11-D16-C16-L200-Z02	●	16	2	16	200	100	11				
AEM90-AZ11-D16-W15-L170-Z02	●	16	2	15	170	50	11				
AEM90-AZ11-D16-W16-L100-Z02	●	16	2	16	100	35	11				
AEM90-AZ11-D16-W16-L150-Z02	●	16	2	16	150	50	11				
AEM90-AZ11-D17-C16-L150-Z02	●	17	2	16	150	30	11				
AEM90-AZ11-D17-C16-L180-Z02	●	17	2	16	180	50	11				
AEM90-AZ11-D17-W16-L100-Z02	●	17	2	16	100	30	11				
AEM90-AZ11-D18-W16-L120-Z02	●	18	2	16	120	18	11		3008-M2.5X6	80-T08	
AEM90-AZ11-D20-C20-L200-Z03	●	20	3	20	200	100	11				
AEM90-AZ11-D20-W19-L170-Z03	●	20	3	19	170	50	11				
AEM90-AZ11-D20-W20-L110-Z02	●	20	2	20	110	35	11				
AEM90-AZ11-D21-C20-L150-Z03	●	21	3	20	150	30	11				
AEM90-AZ11-D21-C20-L180-Z03	●	21	3	20	180	50	11				
AEM90-AZ11-D21-W20-L110-Z03	●	21	3	20	110	35	11				
AEM90-AZ11-D22-C20-L150-Z02	●	22	2	20	150	30	11				
AEM90-AZ11-D25-C24-L180-Z04	●	25	4	24	180	50	11				
AEM90-AZ11-D25-W25-L110-Z04	●	25	4	25	110	40	11				
AEM90-AZ11-D26-C25-L250-Z02	●	26	2	25	250	50	11				
AEM90-AZ11-D26-W25-L120-Z03	●	26	3	25	120	30	11				
AEM90-AZ11-D26-W25-L120-Z04	●	26	4	25	120	40	11				
AEM90-AZ11-D28-C25-L180-Z03	●	28	3	25	180	50	11				
AEM90-AZ11-D28-C25-L250-Z02	●	28	2	25	250	50	11				
AEM90-AZ11-D33-W32-L130-Z04	●	33	4	32	130	50	11				

R: Sağ / Right / Правый L: Sol / Left / Левый

● Stokta / In Stock / В наличии ○ Stokta Yok / Non Stock Item / Нет в наличии
ZCC Ucuna Uygunudur. / Compatible with ZCC Insert. / Под пластину ZCC

Sipariş Örneği/Ordering Example/Образец заказа

1 ad./pcs./шт. AEM90-AZ11-D12-W16-L90-Z01

Kesme Hesabı : S 367 / Cutting Calculation : P 367 / Расчет режимов резания: стр. 367

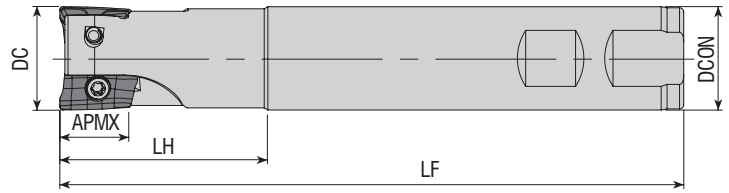

Takım Kodu Ordering Code Код для заказа	Stok Stock Наличие	Takım Ölçüleri (mm) Dimension (mm) Размеры (мм)						Kesici Uç Insert Пластина	Yedek Parçaları / Spare Parts / Запасные части		
		DC	ZEFP	DCON	LF	LH	APMX		Sıkma Vidası Screw Зажимной винт	Tork Anahtar Torx Key Торх Ключ	
AEM90-BD11T3-D16-C16-L100-Z02-H	●	16	2	16	100	30	10	BDMT 11T3..	3008-M2.5x5		
AEM90-BD11T3-D16-W16-L100-Z02-H	●	16	2	16	100	30	10				
AEM90-BD11T3-D16-W16-L150-Z02	●	16	2	16	150	50	10				
AEM90-BD11T3-D16-C16-L160-Z02-H	●	16	2	16	160	50	10				
AEM90-BD11T3-D16-C15-L180-Z02	●	16	2	15	180	50	10				
AEM90-BD11T3-D17-W16-L150-Z02	●	17	2	16	150	25	10				
AEM90-BD11T3-D17-C16-L180-Z02	●	17	2	16	180	25	10				
AEM90-BD11T3-D18-W16-L100-Z02	●	18	2	16	100	25	10				
AEM90-BD11T3-D18-W16-L100-Z02-H	●	18	2	16	100	25	10				
AEM90-BD11T3-D20-W20-L81-Z03-H	●	20	3	20	81	30	10				
AEM90-BD11T3-D20-W20-L100-Z02-H	●	20	2	20	100	30	10				
AEM90-BD11T3-D20-W20-L100-Z03-H	●	20	3	20	100	30	10				
AEM90-BD11T3-D20-C20-L110-Z03-H	●	20	3	20	110	30	10				
AEM90-BD11T3-D20-W20-L150-Z02	●	20	2	20	150	50	10				
AEM90-BD11T3-D20-W20-L150-Z03	●	20	3	20	150	50	10				
AEM90-BD11T3-D20-W20-L150-Z03-H	●	20	3	20	150	50	10				
AEM90-BD11T3-D20-C20-L170-Z03-H	●	20	3	20	170	50	10				
AEM90-BD11T3-D21-W20-L150-Z03	●	21	3	20	150	25	10				
AEM90-BD11T3-D21-C20-L200-Z02	●	21	2	20	200	25	10				
AEM90-BD11T3-D22-W20-L090-Z02-H	●	22	2	20	90	25	10				
AEM90-BD11T3-D25-W25-L100-Z03-H	●	25	3	25	100	30	10				
AEM90-BD11T3-D25-C20-L120-Z03-H	●	25	3	20	120	30	10				
AEM90-BD11T3-D25-C25-L120-Z03-H	●	25	3	25	120	30	10				
AEM90-BD11T3-D25-W25-L150-Z03	●	25	3	25	150	50	10				
AEM90-BD11T3-D26-W25-L150-Z03	●	26	3	25	150	35	10				
AEM90-BD11T3-D26-C25-L250-Z02	●	26	2	25	250	35	10				
AEM90-BD11T3-D32-W32-L110-Z04-H	●	32	4	32	110	40	10				
AEM90-BD11T3-D32-C32-L130-Z04-H	●	32	4	32	130	40	10				
AEM90-BD11T3-D32-W32-L150-Z04	●	32	4	32	150	50	10				
AEM90-BD11T3-D40-W32-L110-Z04-H	●	40	4	32	110	35	10				
AEM90-BD1704-D25-W25-L100-Z02-H	●	25	2	25	100	35	15.7	BDMT 1704..	4015-M4x8	80-T15	
AEM90-BD1704-D25-W25-L150-Z02	●	25	2	25	150	50	15.7				
AEM90-BD1704-D25-C25-L210-Z02-H	●	25	2	25	210	100	15.7				
AEM90-BD1704-D32-W32-L110-Z03-H	●	32	3	32	110	40	15.7				
AEM90-BD1704-D32-C32-L130-Z03-H	●	32	3	32	130	40	15.7				
AEM90-BD1704-D32-W32-L130-Z03-H	●	32	3	32	130	40	15.7				
AEM90-BD1704-D32-W32-L150-Z03	●	32	3	32	150	50	15.7				
AEM90-BD1704-D40-W32-L110-Z04-H	●	40	4	32	110	40	15.7				
AEM90-BD1704-D40-W32-L150-Z04	●	40	4	32	150	40	15.7				

R: Sağ / Right / Правый L: Sol / Left / Левый

● Stokta / In Stock / В наличии ○ Stokta Yok / Non Stock Item / Нет в наличии

KYCR Ucuna Uygundur. / Compatible with KYCR Insert. / Под пластину KYCR

Sipariş Örneği/Ordering Example/Образец заказа

1 ad./pcs./шт. AEM90-BD11T3-D16-C16-L100-Z02-H

Kesme Hesabı : S 367 / Cutting Calculation : P 367 / Расчет режимов резания: стр. 367

S-SİSTEM YÜZEY PARMAK FREZELER

S-SYSTEM END MILLS

S-ТИП КОНЦЕВЫЕ ФРЕЗЫ

KAPR=90°

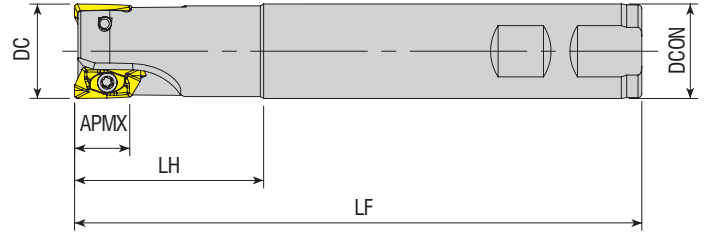

Takım Kodu Ordering Code Код для заказа	Stok Stock Наличие	Takım Ölçüleri (mm) Dimension (mm) Размеры (мм)						Kesici Uç Insert Пластина	Yedek Parçaları / Spare Parts / Запасные части		
		DC	ZEFP	DCON	LF	LH	APMX		Sıkma Vidası Screw Зажимной винт	Tork Anahtar Torx Key Торх Ключ	
AEM90-ED10T3-D16-W16-L120-Z02	●	16	2	16	120	30	30	EDPT 10T3..	3008-M2.5x5	80-T08	
AEM90-ED10T3-D20-W20-L120-Z02	●	20	2	20	120	30	30		3008-M2.5x6		
AEM90-ED1404-D20-W20-L150-Z02	●	20	2	20	150	50	14.5	EDPT 1404..	3008-M3x6		
AEM90-ED1404-D25-W25-L150-Z02	●	25	2	25	150	50	14.5				
AEM90-ED1404-D30-C25-L150-Z03	●	30	3	25	150	50	14.5				

KNMNTL Ucuna Uygundur. / Compatible with KNMNTL Insert. / Под пластину KNMNTL

KAPR=90°

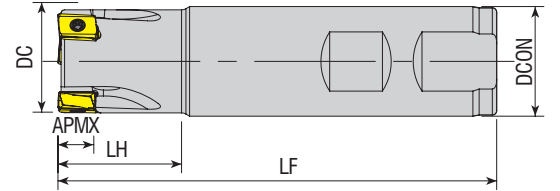

Takım Kodu Ordering Code Код для заказа	Stok Stock Наличие	Takım Ölçüleri (mm) Dimension (mm) Размеры (мм)						Kesici Uç Insert Пластина	Yedek Parçaları / Spare Parts / Запасные части		
		DC	ZEFP	DCON	LF	LH	APMX		Sıkma Vidası Screw Зажимной винт	Tork Anahtar Torx Key Торх Ключ	
AEM90-LN08-D16-W16-L100-Z02-H	●	16	2	16	100	28	8	LNMT 0804..	1707-U4-48x6	80-T07	
AEM90-LN08-D16-W16-L150-Z02	●	16	2	16	150	40	8				1707-U4-48x6.5
AEM90-LN08-D20-W20-L100-Z03-H	●	20	3	20	100	28	8		1707-U4-48x8.2		
AEM90-LN08-D25-W25-L100-Z03-H	●	25	3	25	100	30	8				
AEM90-LN08-D32-W32-L110-Z05-H	●	32	5	32	110	30	8				

R: Sağ / Right / Правый L: Sol / Left / Левый

● Stokta / In Stock / В наличии ○ Stokta Yok / Non Stock Item / Нет в наличии

ISCR Ucuna Uygundur. / Compatible with ISCR Insert. / Под пластину ISCR

Sipariş Örneği/Ordering Example/Образец заказа

1 ad./pcs./шт. AEM90-ED10T3-D16-W16-L120-Z02

Kesme Hesabı : S 367 / Cutting Calculation : P 367 / Расчет режимов резания: стр. 367



www.akko.com.tr

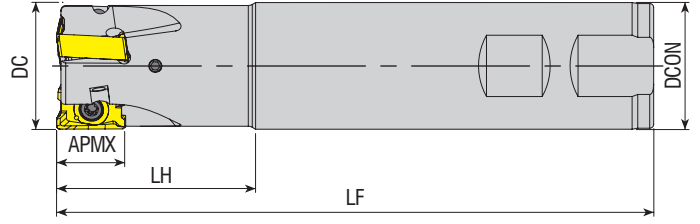

Takım Kodu Ordering Code Код для заказа	Stok Stock Наличие	Takım Ölçüleri (mm) Dimension (mm) Размеры (мм)						Kesici Uç Insert Пластина	Yedek Parçaları / Spare Parts / Запасные части	
		DC	ZEFP	DCON	LF	LH	APMX		Sıkma Vidası Screw Зажимной винт	Tork Anahtar Torx Key Торх Ключ
AEM90-LN15T6-D25-W25-L150-Z02-H	●	25	2	25	150	50	15.5	LNGU 15T6..	4015-M4x12	80-T15
AEM90-LN15T6-D32-W32-L150-Z03-H	●	32	3	32	150	50	15.5			
AEM90-LN15T6-D40-W32-L150-Z03-H	●	40	3	32	150	40	15.5			

KNMTL Ucuna Uygundur. / Compatiple with KNMTL Insert. / Под пластину KNMTL

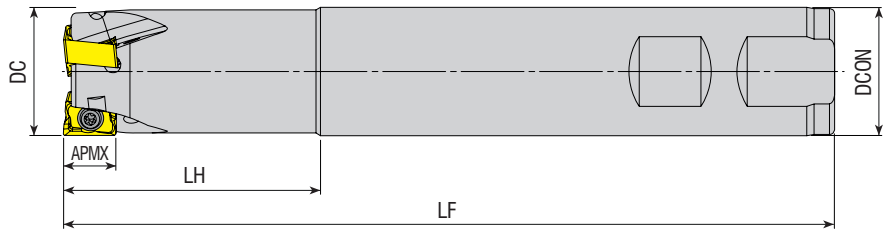

Takım Kodu Ordering Code Код для заказа	Stok Stock Наличие	Takım Ölçüleri (mm) Dimension (mm) Размеры (мм)						Kesici Uç Insert Пластина	Yedek Parçaları / Spare Parts / Запасные части	
		DC	ZEFP	DCON	LF	LH	APMX		Sıkma Vidası Screw Зажимной винт	Tork Anahtar Torx Key Торх Ключ
AEM90-LN1006-D16-W16-L120-Z01-H	●	16	1	16	120	30	9	LN.X 1006..	4010-M3x8	80-T10
AEM90-LN1006-D16-W16-L150-Z01	●	16	1	16	150	50	9			
AEM90-LN1006-D18-W16-L120-Z02-H	●	18	2	16	120	30	9			
AEM90-LN1006-D20-W20-L120-Z02-H	●	20	2	20	120	30	9			
AEM90-LN1006-D20-W20-L150-Z02	●	20	2	20	150	50	9			
AEM90-LN1006-D25-W25-L120-Z03-H	●	25	3	25	120	30	9			
AEM90-LN1006-D25-W25-L150-Z03	●	25	3	25	150	50	9			
AEM90-LN1006-D32-W32-L120-Z04-H	●	32	4	32	120	30	9			
AEM90-LN1006-D32-W32-L150-Z04	●	32	4	32	150	50	9			

R: Sağ / Right / Правый L: Sol / Left / Левый

● Stokta / In Stock / В наличии ○ Stokta Yok / Non Stock Item / Нет в наличии

KRYL Ucuna Uygundur. / Compatiple with KRYL Insert. / Под пластину KRYL

Sipariş Örneği/Ordering Example/Образец заказа

1 ad./pcs./шт. AEM90-LN15T6-D25-W25-L150-Z02-H

Kesme Hesabı : S 367 / Cutting Calculation : P 367 / Расчет режимов резания: стр. 367

KAPR=90°

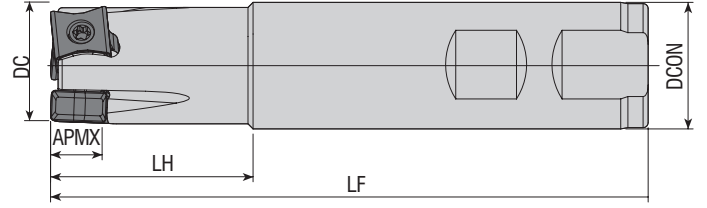

Takım Kodu Ordering Code Код для заказа	Stok Stock Наличие	Takım Ölçüleri (mm) Dimension (mm) Размеры (мм)						Kesici Uç Insert Пластина	Yedek Parçaları / Spare Parts / Запасные части	
		DC	ZEPF	DCON	LF	LH	APMX		Sıkma Vidası Screw Зажимной винт	Tork Anahtar Torx Key Торх Ключ
AEM90-LN1106-D25-W25-L150-Z03	●	25	3	25	150	40	10	LNMT 1106..	4015-M3.5x11	80-T15
AEM90-LN1106-D32-W32-L150-Z04	●	32	4	32	150	40	10			
AEM90-LN1106-D40-W32-L150-Z05	●	40	5	32	150	40	10			

ISCR-ХТС-GSC Ucuna Uygundur. / Compatible with ISCR-ХТС-GSC Insert. / Под пластину ISCR-ХТС-GSC.

KAPR=90°

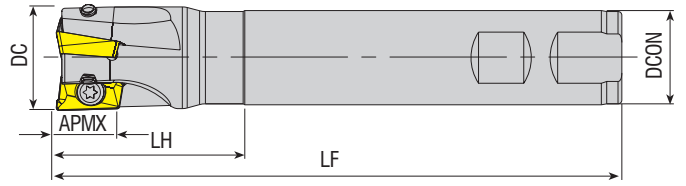

Takım Kodu Ordering Code Код для заказа	Stok Stock Наличие	Takım Ölçüleri (mm) Dimension (mm) Размеры (мм)						Kesici Uç Insert Пластина	Yedek Parçaları / Spare Parts / Запасные части	
		DC	ZEPF	DCON	LF	LH	APMX		Sıkma Vidası Screw Зажимной винт	Tork Anahtar Torx Key Торх Ключ
AEM90-R390.11-D12-W12-L100-Z01	●	12	1	12	100	25	10	R390-11T3..	3008-M2.5x5	80-T08
AEM90-R390.11-D16-W16-L100-Z02-H	●	16	2	16	100	30	10			
AEM90-R390.11-D16-W16-L150-Z02	●	16	2	16	150	50	10			
AEM90-R390.11-D16-W16-L150-Z02-H	●	16	2	16	150	50	10			
AEM90-R390.11-D20-W20-L090-Z02-H	●	20	2	20	90	30	10			
AEM90-R390.11-D20-W20-L100-Z03-H	●	20	3	20	100	30	10			
AEM90-R390.11-D20-W20-L150-Z03	●	20	3	20	150	50	10			
AEM90-R390.11-D20-W20-L150-Z03-H	●	20	3	20	150	50	10			
AEM90-R390.11-D20-C20-L150-Z03	●	20	3	20	150	30	10			
AEM90-R390.11-D22-W20-L090-Z02-H	●	22	2	20	90	30	10			
AEM90-R390.11-D25-C20-L150-Z03	●	25	3	20	150	40	10			
AEM90-R390.11-D25-W25-L100-Z03-H	●	25	3	25	100	30	10			
AEM90-R390.11-D25-W25-L150-Z03	●	25	3	25	150	50	10			
AEM90-R390.11-D25-W25-L150-Z03-H	●	25	3	25	150	50	10			
AEM90-R390.11-D30-W25-L150-Z04-H	●	30	4	25	150	30	10			
AEM90-R390.11-D32-C25-L200-Z03	●	32	3	25	200	40	10			
AEM90-R390.11-D32-W32-L150-Z05-H	●	32	5	32	150	50	10			
AEM90-R390.17-D25-W25-L150-Z02	●	25	2	25	150	50	15.4	R390-1704..	4015-M3.5x8	80-T15
AEM90-R390.17-D25-W25-L150-Z02-H	●	25	2	25	150	50	15.4			
AEM90-R390.17-D30-W25-L150-Z03	●	30	3	25	150	40	15.4			
AEM90-R390.17-D30-W25-L150-Z03-H	●	30	3	25	150	40	15.4			
AEM90-R390.17-D32-W32-L150-Z03-H	●	32	3	32	150	40	15.4			
AEM90-R390.18-D32-C32-L150-Z03	●	32	3	32	150	45	15.4	R390-1806..	4015-M4x11	

R: Sağ / Right / Правый L: Sol / Left / Левый

● Stokta / In Stock / В наличии ○ Stokta Yok / Non Stock Item / Нет в наличии

SNDVK Ucuna Uygundur. / Compatible with SNDVK Insert. / Под пластину SNDVK

Sipariş Örneği/Ordering Example/Образец заказа

1 ad./pcs./шт. AEM90-LN1106-D25-W25-L150-Z03

Kesme Hesabı : S 367 / Cutting Calculation : P 367 / Расчет режимов резания: стр. 367

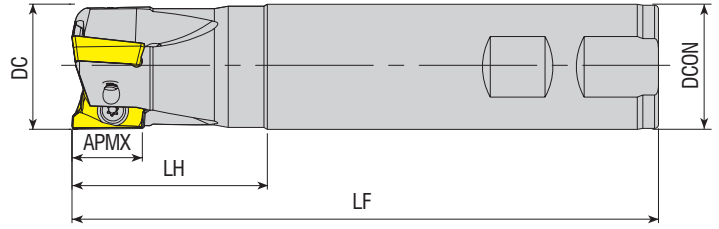

Takım Kodu Ordering Code Код для заказа	Stok Stock Наличие	Takım Ölçüleri (mm) Dimension (mm) Размеры (мм)						Kesici Uç Insert Пластина	Yedek Parçaları / Spare Parts / Запасные части	
		DC	ZEPF	DCON	LF	LH	APMX		Sıkma Vidası Screw Зажимной винт	Tork Anahtar Torx Key Торх Ключ
AEM90-RT07-D10-W10-L120-Z02	●	10	2	10	120	30	7	RT 0702	3006-M2x4	80-T06
AEM90-RT07-D12-C12-L120-Z02	●	12	2	12	120	30	7			
AEM90-RT07-D12-W12-L120-Z02	●	12	2	12	120	30	7			
AEM90-RT07-D14-W12-L120-Z02	●	14	2	12	120	30	7			
AEM90-RT10-D16-C15-L160-Z02	●	16	2	15	160	30	10	RT 1003	3008-M2.5x6	80-T08
AEM90-RT10-D16-W16-L120-Z02-H	●	16	2	16	120	30	10			
AEM90-RT10-D16-W16-L150-Z02	●	16	2	16	150	30	10			
AEM90-RT10-D16-C16-L200-Z02	●	16	2	16	200	100	10			
AEM90-RT10-D17-W16-L160-Z02	●	17	2	16	160	30	10			
AEM90-RT10-D17-C16-L200-Z02	●	17	2	16	200	30	10			
AEM90-RT10-D18-W16-L120-Z02-H	●	18	2	16	120	30	10			
AEM90-RT10-D20-C19-L200-Z03	●	20	3	19	200	30	10			
AEM90-RT10-D20-C20-L110-Z03	●	20	3	20	110	30	10			
AEM90-RT10-D20-W20-L120-Z03-H	●	20	3	20	120	30	10			
AEM90-RT10-D20-W20-L150-Z03	●	20	3	20	150	50	10			
AEM90-RT10-D20-C20-L200-Z03	●	20	3	20	200	100	10			
AEM90-RT10-D21-W20-L200-Z03	●	21	3	20	200	30	10			
AEM90-RT10-D22-W20-L120-Z03-H	●	22	3	20	120	30	10			
AEM90-RT10-D22-C20-L150-Z03	●	22	3	20	150	30	10			
AEM90-RT10-D22-C20-L200-Z03	●	22	3	20	200	30	10			
AEM90-RT10-D25-W25-L120-Z04-H	●	25	4	25	120	40	10			
AEM90-RT10-D25-W25-L150-Z04	●	25	4	25	150	50	10			
AEM90-RT10-D25-C25-L200-Z04	●	25	4	25	200	100	10			
AEM90-RT10-D26-C25-L250-Z04	●	26	4	25	250	32	10			
AEM90-RT10-D32-W32-L120-Z05-H	●	32	5	32	120	50	10			
AEM90-RT10-D32-W32-L150-Z05	●	32	5	32	150	50	10			
AEM90-RT10-D32-C32-L200-Z05	●	32	5	32	200	100	10			
AEM90-RT10-D33-C32-L250-Z04	●	33	4	32	250	32	10			
AEM90-RT13-D32-C32-L250-Z04	●	32	4	32	250	50	13	RT 1304	3008-M3x8	
AEM90-RT16-D25-W25-L120-Z02-H	●	25	2	25	120	40	16	RT 1606	4015-M4x9	80-T15
AEM90-RT16-D25-W25-L150-Z02	●	25	2	25	150	50	16			
AEM90-RT16-D25-C25-L200-Z02	●	25	2	25	200	100	16			
AEM90-RT16-D32-W32-L120-Z03-H	●	32	3	32	120	50	16			
AEM90-RT16-D32-W32-L150-Z03	●	32	3	32	150	50	16			
AEM90-RT16-D32-C32-L200-Z03	●	32	3	32	200	100	16			
AEM90-RT16-D32-C32-L250-Z03	●	32	3	32	250	100	16			
AEM90-RT16-D32-C32-L270-Z03	●	32	3	32	270	100	16			
AEM90-RT16-D40-W32-L120-Z04-H	●	40	4	32	120	50	16			
AEM90-RT16-D40-W32-L150-Z04	●	40	4	32	150	50	16			
AEM90-RT16-D40-C32-L200-Z04	●	40	4	32	200	100	16	4015-M4x11		

R: Sağ / Right / Правый L: Sol / Left / Левый

● Stokta / In Stock / В наличии ○ Stokta Yok / Non Stock Item / Нет в наличии
SFTY Uçuna Uygundur. / Compatible with SFTY Insert. / Под пластину SFTY

Sipariş Örneği/Ordering Example/Образец заказа

1 ad./pcs./шт. AEM90-RT07-D10-W10-L120-Z02

Kesme Hesabı : S 367 / Cutting Calculation : P 367 / Расчет режимов резания: стр. 367

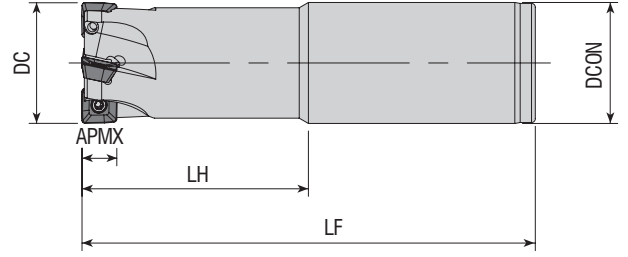

Takım Kodu Ordering Code Код для заказа	Stok Stock Наличие	Takım Ölçüleri (mm) Dimension (mm) Размеры (мм)						Kesici Uç Insert Пластина	Yedek Parçaları / Spare Parts / Запасные части		
		DC	ZEFP	DCON	LF	LH	APMX		Sıkma Vidası Screw Зажимной винт	Tork Anahtar Torx Key Торх Ключ	
AEM90-SE09-D25-C25-L120-Z03-H	●	25	3	25	120	60	6.7	SEET 09T3..		80-T08	
AEM90-SE09-D25-C25-L150-Z02	●	25	2	25	150	50	6.7				
AEM90-SE09-D32-C32-L120-Z04-H	●	32	4	32	120	60	6.7				
AEM90-SE09-D32-C32-L150-Z03	●	32	3	32	150	50	6.7				

ZCC Ucuna Uygundur. / Compatible with ZCC Insert. / Под пластину ZCC

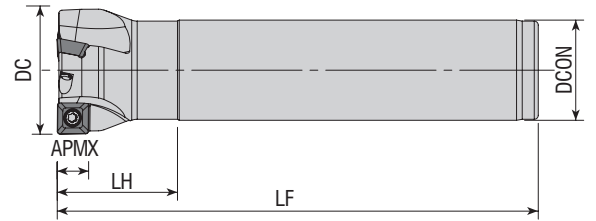

Takım Kodu Ordering Code Код для заказа	Stok Stock Наличие	Takım Ölçüleri (mm) Dimension (mm) Размеры (мм)						Kesici Uç Insert Пластина	Yedek Parçaları / Spare Parts / Запасные части		
		DC	ZEFP	DCON	LF	LH	APMX		Sıkma Vidası Screw Зажимной винт	Tork Anahtar Torx Key Торх Ключ	
AEM90-S00803-D20-C16-L110-Z02-H	●	20	2	16	110	25	7	SOMT 0803..		80-T08	
AEM90-S00803-D25-C20-L110-Z02-H	●	25	2	20	110	25	7				
AEM90-S00803-D32-C25-L120-Z03-H	●	32	3	25	120	30	7				

R: Sağ / Right / Правый L: Sol / Left / Левый

● Stokta / In Stock / В наличии ○ Stokta Yok / Non Stock Item / Нет в наличии
SMTM Ucuna Uygundur. / Compatible with SMTM Insert. / Под пластину SMTM.

Sipariş Örneği/Ordering Example/Образец заказа

1 ad./pcs./шт. AEM90-SE09-D25-C25-L120-Z03-H

Kesme Hesabı : S 367 / Cutting Calculation : P 367 / Расчет режимов резания: стр. 367

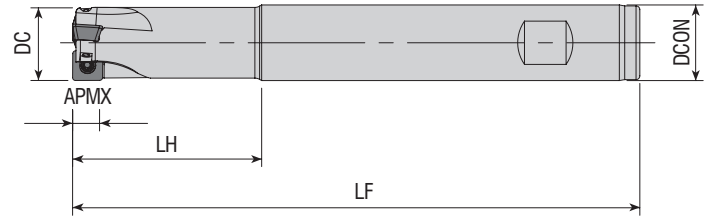

Takım Kodu Ordering Code Код для заказа	Stok Stock Наличие	Takım Ölçüleri (mm) Dimension (mm) Размеры (мм)						Kesici Uç Insert Пластина	Yedek Parçaları / Spare Parts / Запасные части		
		DC	ZEFP	DCON	LF	LH	APMX		Sıkma Vidası Screw Зажимной винт	Tork Anahtar Torx Key Торх Ключ	
AEM90-SPGT0602-D16-W16-L150-Z02	●	16	2	16	150	50	5.5				
AEM90-SPGT07T3-D20-W20-L150-Z03	●	20	3	20	150	50	7				
AEM90-SPGT07T3-D25-W25-L150-Z03	●	25	3	25	150	50	7				
AEM90-SPGT0904-D30-W32-L150-Z03	●	30	3	32	150	50	9				

ZCC Ucuna Uygundur. / Compatible with ZCC Insert. / Под пластину ZCC

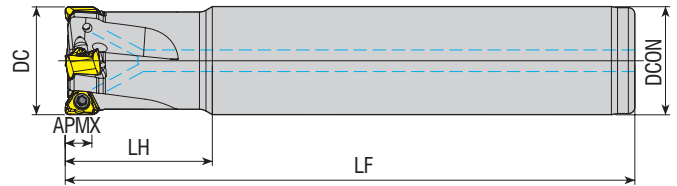

Takım Kodu Ordering Code Код для заказа	Stok Stock Наличие	Takım Ölçüleri (mm) Dimension (mm) Размеры (мм)						Kesici Uç Insert Пластина	Yedek Parçaları / Spare Parts / Запасные части		
		DC	ZEFP	DCON	LF	LH	APMX		Sıkma Vidası Screw Зажимной винт	Tork Anahtar Torx Key Торх Ключ	
AEM90-TNG10-D20-C20-L125-Z02-H	●	20	2	20	125	29	5				
AEM90-TNG10-D20-C20-L125-Z03-H	●	20	3	20	125	29	5				
AEM90-TNG10-D20-C20-L150-Z03-H	○	20	3	20	150	50	5				
AEM90-TNG10-D21-C20-L200-Z03-H	●	21	3	20	200	30	5				
AEM90-TNG10-D25-C25-L150-Z03-H	●	25	3	25	150	34	5				
AEM90-TNG10-D25-C25-L150-Z04-H	●	25	4	25	150	34	5				
AEM90-TNG10-D25-C25-L170-Z04-H	○	25	4	25	170	50	5				
AEM90-TNG10-D26-C25-L250-Z04-H	●	26	4	25	250	35	5				
AEM90-TNG10-D32-C32-L170-Z04-H	●	32	4	32	170	37	5				
AEM90-TNG10-D32-C32-L170-Z05-H	○	32	5	32	170	37	5				
AEM90-TNG10-D33-C32-L250-Z05-H	●	33	5	32	250	35	5				

R: Sağ / Right / Правый L: Sol / Left / Левый

● Stokta / In Stock / В наличии ○ Stokta Yok / Non Stock Item / Нет в наличии
PRMT Ucuna Uygundur. / Compatible with PRMT Insert. / Под пластину PRMT.

Sipariş Örneği/Ordering Example/Образец заказа

1 ad./pcs./шт. AEM90-SPGT0602-D16-W16-L150-Z02

Kesme Hesabı : S 367 / Cutting Calculation : P 367 / Расчет режимов резания: стр. 367



KAPR=90°

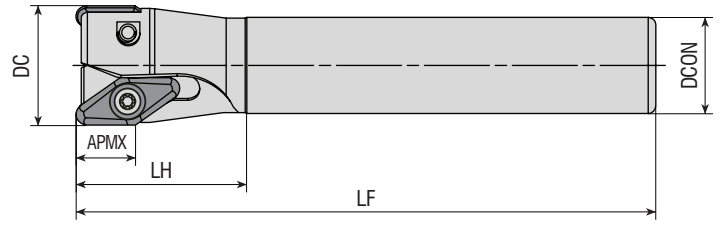

Takım Kodu Ordering Code Код для заказа	Stok Stock Наличие	Takım Ölçüleri (mm) Dimension (mm) Размеры (мм)						Kesici Uç Insert Пластина	Yedek Parçaları / Spare Parts / Запасные части	
		DC	ZEPF	DCON	LF	LH	APMX		Sıkma Vidası Screw Зажимной винт	Tork Anahtar Torx Key Торх Ключ
AEM90-VC2205-D32-C25-L150-Z02-H	●	32	2	25	150	50	15	VCKT 2205..		
AEM90-VC2205-D40-C32-L150-Z03-H	●	40	3	32	150	50	15			

ISO Ucuna Uygunudur. / Compatible with ISO Insert. / Под пластину ISO.



KAPR=90°

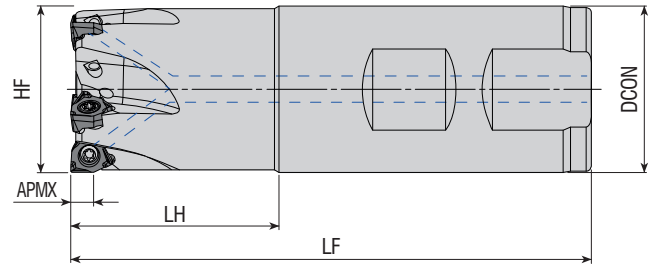

Takım Kodu Ordering Code Код для заказа	Stok Stock Наличие	Takım Ölçüleri (mm) Dimension (mm) Размеры (мм)						Kesici Uç Insert Пластина	Yedek Parçaları / Spare Parts / Запасные части	
		DC	ZEPF	DCON	LF	LH	APMX		Sıkma Vidası Screw Зажимной винт	Tork Anahtar Torx Key Торх Ключ
AEM90-WNG04-D20-W20-L81-Z03-H	●	20	3	20	81	31	4	WNGU 0403..		
AEM90-WNG04-D20-C20-L170-Z03-H	●	20	3	20	170	50	4			
AEM90-WNG04-D25-W25-L88-Z03-H	●	25	3	25	88	32	4			
AEM90-WNG04-D25-W25-L88-Z04-H	●	25	4	25	88	32	4			
AEM90-WNG04-D25-C25-L170-Z03-H	●	25	3	25	170	50	4			
AEM90-WNG04-D32-W25-L100-Z05-H	●	32	5	25	100	35	4			
AEM90-WNG04-D32-W32-L100-Z05-H	●	32	5	32	100	40	4			
AEM90-WNG04-D32-C25-L170-Z04-H	●	32	4	25	170	35	4			
AEM90-WNG04-D32-C32-L170-Z04-H	●	32	4	32	170	50	4			
AEM90-WNG08-D40-W32-L100-Z03-H	●	40	3	32	100	35	7.5	WNGU 0806..		
AEM90-WNG08-D40-C32-L170-Z03-H	●	40	3	32	170	35	7.5			

R: Sağ / Right / Правый L: Sol / Left / Левый

● Stokta / In Stock / В наличии ○ Stokta Yok / Non Stock Item / Нет в наличии

XTC-GSC Ucuna Uygunudur. / Compatible with XTC-GSC Insert. / Под пластину XTC-GSC

Sipariş Örneği/Ordering Example/Образец заказа

1 ad./pcs./шт. AEM90-VC2205-D32-C25-L150-Z02-H

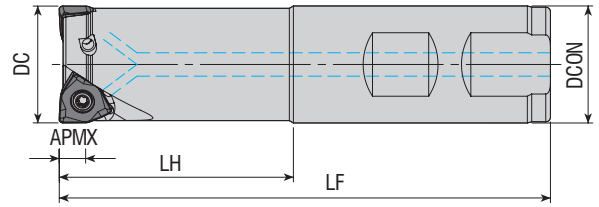

Takım Kodu Ordering Code Код для заказа	Stok Stock Наличие	Takım Ölçüleri (mm) Dimension (mm) Размеры (мм)						Kesici Uç Insert Пластина	Yedek Parçaları / Spare Parts / Запасные части	
		DC	ZEPF	DCON	LF	LH	APMX		Sıkma Vidası Screw Зажимной винт	Tork Anahtar Torx Key Торх Ключ
AEM90L-WN0604Z-D25-C25-L200-Z02-H	●	25	2	25	200	100	5.7			
AEM90-WN0604Z-D25-W25-L150-Z02-H	●	25	2	25	150	50	5.7			
AEM90-WN0604Z-D32-W32-L150-Z03-H	●	32	3	32	150	50	5.7			
AEM90-WN0604Z-D40-W32-L150-Z04-H	●	40	4	32	150	35	5.7			

ZCC Ucuna Uygunudur. / Compatible with ZCC Insert. / Под пластину ZCC

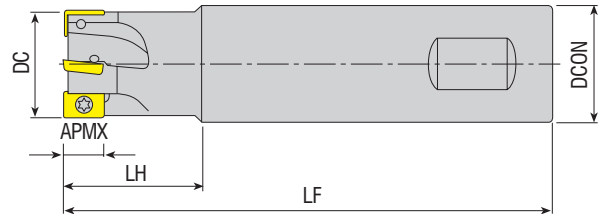

Takım Kodu Ordering Code Код для заказа	Stok Stock Наличие	Takım Ölçüleri (mm) Dimension (mm) Размеры (мм)						Kesici Uç Insert Пластина	Yedek Parçaları / Spare Parts / Запасные части	
		DC	ZEPF	DCON	LF	LH	APMX		Sıkma Vidası Screw Зажимной винт	Tork Anahtar Torx Key Торх Ключ
AEM90-XD11T3-D16-W16-L150-Z02	●	16	2	16	150	30	10			
AEM90-XD11T3-D17-C16-L150-Z02	●	17	2	16	150	30	10			
AEM90-XD11T3-D20-W20-L150-Z03	●	20	3	20	150	50	10			
AEM90-XD11T3-D21-C20-L080-Z03-H	●	21	3	20	80	25	10			
AEM90-XD11T3-D21-C20-L150-Z03	●	21	3	20	150	30	10			
AEM90-XD11T3-D25-W25-L150-Z04	●	25	4	25	150	50	10			
AEM90-XD11T3-D30-W25-L120-Z04	●	30	4	25	120	30	10			
AEM90-XD11T3-D32-W32-L150-Z04	●	32	4	32	150	50	10			
AEM90-XD11T3-D33-C20-L080-Z04-H	●	33	4	20	80	30	10			

R: Sağ / Right / Правый L: Sol / Left / Левый

● Stokta / In Stock / В наличии ○ Stokta Yok / Non Stock Item / Нет в наличии
CRTZT Ucuna Uygunudur. / Compatible with CRTZT Insert. / Под пластину CRTZT

Sipariş Örneği/Ordering Example/Образец заказа

1 ad./pcs./шт. AEM90L-WN0604Z-D25-C25-L200-Z02-H

Kesme Hesabı : S 367 / Cutting Calculation : P 367 / Расчет режимов резания: стр. 367

KAPR=90°

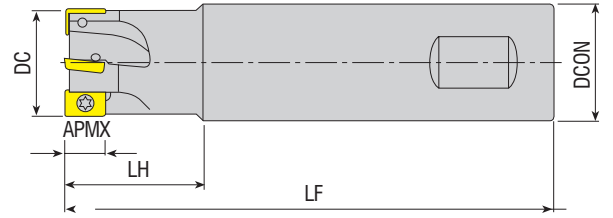

Takım Kodu Ordering Code Код для заказа	Stok Stock Наличие	Takım Ölçüleri (mm) Dimension (mm) Размеры (мм)						Kesici Uç Insert Пластина	Yedek Parçaları / Spare Parts / Запасные части	
		DC	ZEPF	DCON	LF	LH	APMX		Sıkma Vidası Screw Зажимной винт	Tork Anahtar Torx Key Торх Ключ
AEM90-XC13-D20-W20-L150-Z02	●	20	2	20	150	60	13	XCKX 13T3..	3008-M3x6	80-T08
AEM90-XC13-D25-W25-L150-Z03	●	25	3	25	150	60	13		3008-M3x8	
AEM90-XC13-D32-W32-L150-Z04	●	32	4	32	150	60	13			

SC Ucuna Uygun dur. / Compatiple with SC Insert. / Под пластину SC

KAPR=90°

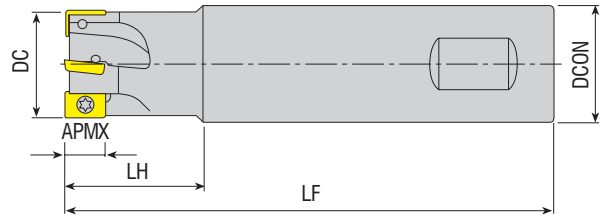
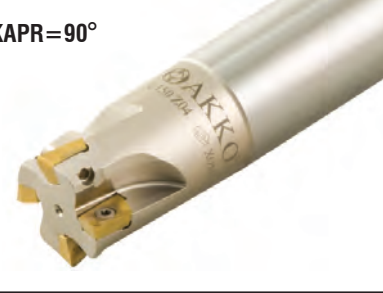

Takım Kodu Ordering Code Код для заказа	Stok Stock Наличие	Takım Ölçüleri (mm) Dimension (mm) Размеры (мм)						Kesici Uç Insert Пластина	Yedek Parçaları / Spare Parts / Запасные части	
		DC	ZEPF	DCON	LF	LH	APMX		Sıkma Vidası Screw Зажимной винт	Tork Anahtar Torx Key Торх Ключ
AEM90-X006-D10-C12-L120-Z02	●	10	2	12	120	50	5	XO.. 0602..	3006-M1.8x4	80-T06
AEM90-X006-D12-C12-L120-Z02	●	12	2	12	120	25	5			
AEM90-X009-D16-W16-L150-Z02	●	16	2	16	150	50	8	XO.. 0903..	3008-M2.5x5	80-T08
AEM90-X009-D20-W20-L150-Z03	●	20	3	20	150	50	8			
AEM90-X012-D20-W20-L150-Z02	●	20	2	20	150	50	11	XO.. 1204..	3010-M3.5x7	80-T10
AEM90-X012-D20-C20-L200-Z02	●	20	2	20	200	100	11			
AEM90-X012-D22-W20-L150-Z02	●	22	2	20	150	30	11			
AEM90-X012-D25-W25-L150-Z03	●	25	3	25	150	50	11			
AEM90-X012-D25-C25-L200-Z03	●	25	3	25	200	100	11			
AEM90-X012-D32-C25-L150-Z04	●	32	4	25	150	40	11			
AEM90-X012-D32-W32-L150-Z04	●	32	4	32	150	50	11			
AEM90-X012-D32-C32-L250-Z04	●	32	4	32	250	100	11			

R: Sağ / Right / Правый L: Sol / Left / Левый

● Stokta / In Stock / В наличии ○ Stokta Yok / Non Stock Item / Нет в наличии

SC Ucuna Uygun dur. / Compatiple with SC Insert. / Под пластину SC

Sipariş Örneği/Ordering Example/Образец заказа

1 ad./pcs./шт. AEM90-XC13-D20-W20-L150-Z02

Kesme Hesabı : S 367 / Cutting Calculation : P 367 / Расчет режимов резания: стр. 367

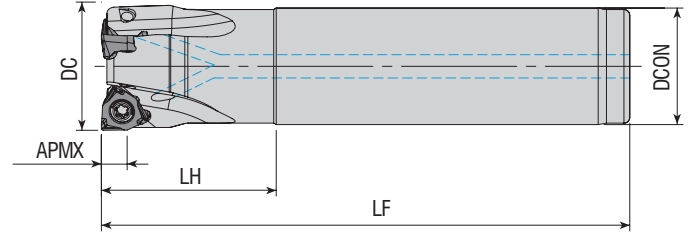

Takım Kodu Ordering Code Код для заказа	Stok Stock Наличие	Takım Ölçüleri (mm) Dimension (mm) Размеры (мм)						Kesici Uç Insert Пластина	Yedek Parçaları / Spare Parts / Запасные части				
		DC	ZEPF	DCON	LF	LH	APMX		Sıkma Vidası Screw Зажимной винт	Tork Anahtar Torx Key Торх Ключ			
AEM90-XN0403-D16-C16-L100-Z01-H	●	16	1	16	100	30	4						
AEM90-XN0403-D22-C20-L110-Z03-H	●	22	3	20	110	30	4				XNEX 0403..	3008-M2.5x6	80-T08
AEM90-XN0806-D32-C32-L110-Z02-H	●	32	2	32	110	40	7.5				XNEX 0806..	4015-M4x11	80-T15

SC Ucuna Uygundur. / Compatible with SC Insert. / Под пластину SC

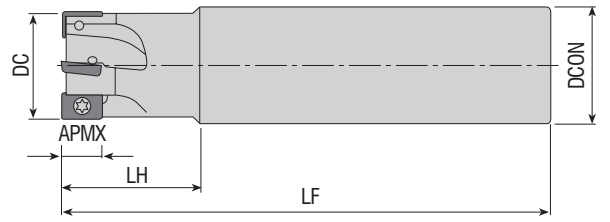

Takım Kodu Ordering Code Код для заказа	Stok Stock Наличие	Takım Ölçüleri (mm) Dimension (mm) Размеры (мм)						Kesici Uç Insert Пластина	Yedek Parçaları / Spare Parts / Запасные части				
		DC	ZEPF	DCON	LF	LH	APMX		Sıkma Vidası Screw Зажимной винт	Tork Anahtar Torx Key Торх Ключ			
AEM90-ZC1003-D16-C14-L150-Z02	●	16	2	14	150	25	9						
AEM90-ZC1003-D16-C14-L200-Z02	●	16	2	14	200	25	9				ZCMT 100308R	3008-M2.5x6	80-T08
AEM90-ZC1003-D16-C15-L150-Z02	●	16	2	15	150	25	9						
AEM90-ZC1003-D16-C16-L150-Z02	●	16	2	16	150	25	9						
AEM90-ZC1003-D16-C16-L200-Z02	●	16	2	16	200	50	9						
AEM90-ZC1003-D17-C16-L150-Z02	●	17	2	16	150	25	9						
AEM90-ZC1003-D17-C16-L200-Z02	●	17	2	16	200	25	9						
AEM90-ZC1003-D20-C18-L150-Z03	●	20	3	18	150	25	9						
AEM90-ZC1003-D20-C18-L200-Z02	●	20	2	18	200	25	9						
AEM90-ZC1003-D20-C20-L150-Z03	●	20	3	20	150	40	9						
AEM90-ZC1003-D20-C18-L200-Z03	●	20	3	18	200	25	9						
AEM90-ZC1003-D21-C20-L150-Z02	●	21	2	20	150	30	9						
AEM90-ZC1003-D21-C20-L150-Z03	●	21	3	20	150	30	9						
AEM90-ZC1003-D21-C20-L200-Z03	●	21	3	20	200	30	9						
AEM90-ZC1003-D25-C20-L150-Z03	●	25	3	20	150	30	9						
AEM90-ZC1003-D25-C20-L200-Z03	●	25	3	20	200	30	9						
AEM90-ZC1003-D25-C25-L150-Z03	●	25	3	25	150	40	9						
AEM90-ZC1003-D26-C25-L170-Z03	●	26	3	25	170	25	9						
AEM90-ZC1003-D26-C25-L200-Z03	●	26	3	25	200	25	9						
AEM90-ZC1003-D32-C25-L180-Z04	●	32	4	25	180	30	9						
AEM90-ZC1003-D33-C32-L200-Z04	●	33	4	32	200	25	9						

R: Sağ / Right / Правый L: Sol / Left / Левый

● Stokta / In Stock / В наличии ○ Stokta Yok / Non Stock Item / Нет в наличии

DJT Ucuna Uygundur. / Compatible with DJT Insert. / Под пластину SMTM-DJT

Sipariş Örneği/Ordering Example/Образец заказа

1 ad./pcs./шт. AEM90-XN0403-D16-C16-L100-Z01-H

Kesme Hesabı : S 367 / Cutting Calculation : P 367 / Расчет режимов резания: стр. 367

KAPR=90°

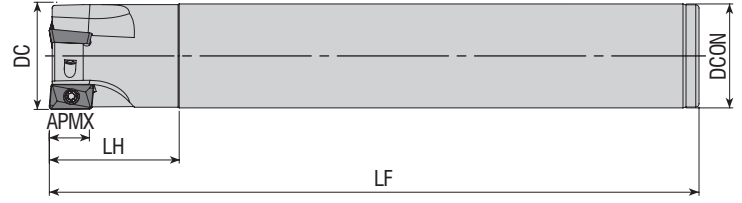

Takım Kodu Ordering Code Код для заказа	Stok Stock Наличие	Takım Ölçüleri (mm) Dimension (mm) Размеры (мм)						Kesici Uç Insert Пластина	Yedek Parçaları / Spare Parts / Залпасные части		
		DC	ZAFP	DCON	LF	LH	APMX		Sıkma Vidası Screw Зажимной винт	Tork Anahtar Torx Key Торх Ключ	
AEM90-ZP13T3-D26-C25-L200-Z02	●	26	2	25	200	35	13	ZPMT 13T3..	4010-M3x8	80-T10	
AEM90-ZP13T3-D26-C25-L200-Z03	●	26	3	25	200	35	13				
AEM90-ZP13T3-D26-C25-L250-Z02	●	26	2	25	250	35	13				
AEM90-ZP13T3-D33-C32-L200-Z03	●	33	3	32	200	40	13				
AEM90-ZP13T3-D33-C32-L250-Z03	●	33	3	32	250	40	13				

DJT Ucuna Uygunudur. / Compatible with DJT Insert. / Под пластину SMTM-DJT

KAPR=90°

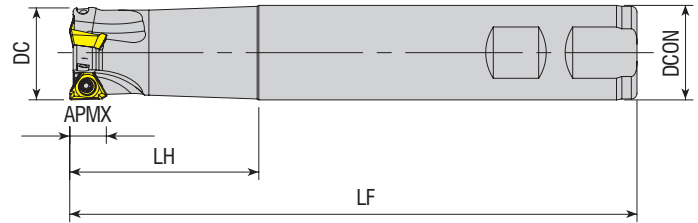

Takım Kodu Ordering Code Код для заказа	Stok Stock Наличие	Takım Ölçüleri (mm) Dimension (mm) Размеры (мм)						Kesici Uç Insert Пластина	Yedek Parçaları / Spare Parts / Залпасные части		
		DC	ZAFP	DCON	LF	LH	APMX		Sıkma Vidası Screw Зажимной винт	Tork Anahtar Torx Key Торх Ключ	
AEM90-3P0603-D16-W16-L120-Z03-H	●	16	3	16	120	25	4.7	3PKT 0603	3006-M2x4	80-T06	
AEM90-3P0603-D20-W20-L150-Z03-H	●	20	3	20	150	25	4.7				
AEM90-3P0603-D25-W25-L150-Z05-H	●	25	5	25	150	25	4.7				
AEM90-3P1004-D20-W20-L150-Z02	●	20	2	20	150	40	7	3PKT 1004	1108-M2.5x6	80-T08	
AEM90-3P1004-D21-C20-L200-Z02	●	21	2	20	200	30	7				
AEM90-3P1004-D25-W25-L150-Z03	●	25	3	25	150	40	7				
AEM90-3P1505-D32-W32-L150-Z03	●	32	3	32	150	50	11	3PKT 1505	1115-M4x10	80-T15	
AEM90-3P1505-D38-W32-L150-Z03	●	38	3	32	150	35	11				
AEM90-3P1505-D40-W32-L150-Z04	●	40	4	32	150	35	11				

R: Sağ / Right / Правый L: Sol / Left / Левый

● Stokta / In Stock / В наличии ○ Stokta Yok / Non Stock Item / Нет в наличии

TGTC Ucuna Uygunudur. / Compatible with TGTC Insert. / Под пластину TGTC.

Sipariş Örneği/Ordering Example/Образец заказа

1 ad./pcs./шт. AEM90-ZP13T3-D26-C25-L200-Z02

Kesme Hesabı : S 367 / Cutting Calculation : P 367 / Расчет режимов резания: стр. 367

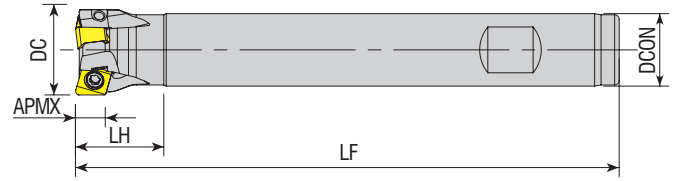

Takım Kodu Ordering Code Код для заказа	Stok Stock Наличие	Takım Ölçüleri (mm) Dimension (mm) Размеры (мм)						Kesici Uç Insert Пластина	Yedek Parçaları / Spare Parts / Запасные части		
		DC	ZEFP	DCON	LF	LH	APMX		Sıkma Vidası Screw Зажимной винт	Baskı Parçası Wedge Clamp Прижим	Baskı Vidası Clamp Screw Зажимной винт
AEM90-4N06-D16-W16-L120-Z02-H	●	16	2	16	120	25	6	4NKT 0603..	1108-M3x6.8	80-T08	
AEM90-4N06-D16-W16-L160-Z02	●	16	2	16	160	25	6				
AEM90-4N06-D20-W16-L120-Z03-H	●	20	3	16	120	20	6				
AEM90-4N06-D20-W16-L160-Z03	●	20	3	16	160	20	6				

TGTC Ucuna Uygundur. / Compatible with TGTC Insert. / Под пластину TGTC.

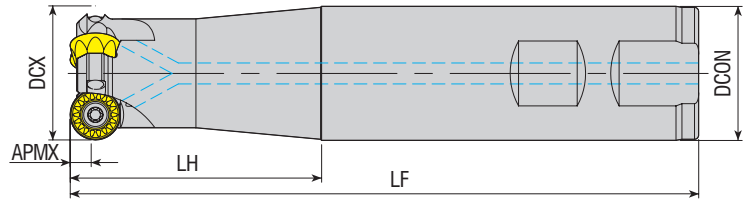

Takım Kodu Ordering Code Код для заказа	Stok Stock Наличие	Takım Ölçüleri (mm) Dimension (mm) Размеры (мм)						Kesici Uç Insert Пластина	Yedek Parçaları / Spare Parts / Запасные части			
		DCX	ZEFP	DCON	LF	LH	APMX		Sıkma Vidası Screw Зажимной винт	Baskı Parçası Wedge Clamp Прижим	Baskı Vidası Clamp Screw Зажимной винт	Tork Anahtar Torx Key Торх Ключ
AEMR-RP08T2M-D20-W20-L150-Z02-H	●	20	2	20	150	60	4	RPMT 08T2..	3008-M2.5x6	-	-	80-T08
AEMR-RP08T2M-D25-W25-L200-Z03-H	●	25	3	25	200	100	4					
AEMR-RP10T3M-D25-W25-L200-Z02-H	●	25	2	25	200	100	5	RPMT 10T3..	4015-M3.5x9	-	-	80-T15
AEMR-RP10T3M-D32-W32-L200-Z03-H	●	32	3	32	200	100	5					
AEMR-RP1204M-D32-W32-L150-Z03-H	●	32	3	32	150	60	6	RPMT 1204..	4015-M4x9	-	-	80-T15
AEMR-RP1204M-D32-W32-L200-Z03-H	●	32	3	32	200	100	6					
AEMR-RP1606M-D40-W32-L150-Z02-H	●	40	2	16	150	35	8	RPMT 1606..	1020-M5x11	-	-	80-T20
AEMR-RP1606M-D40-W32-L200-Z02-H	●	40	2	16	200	35	8					

R: Sağ / Right / Правый L: Sol / Left / Левый

● Stokta / In Stock / В наличии ○ Stokta Yok / Non Stock Item / Нет в наличии

MTSBSH Ucuna Uygundur. / Compatible with MTSBSH Insert. / Под пластину MTSBSH

Sipariş Örneği/Ordering Example/Образец заказа

1 ad./pcs./шт. AEM90-4N06-D16-W16-L120-Z02-H

Kesme Hesabı : S 367 / Cutting Calculation : P 367 / Расчет режимов резания: стр. 367

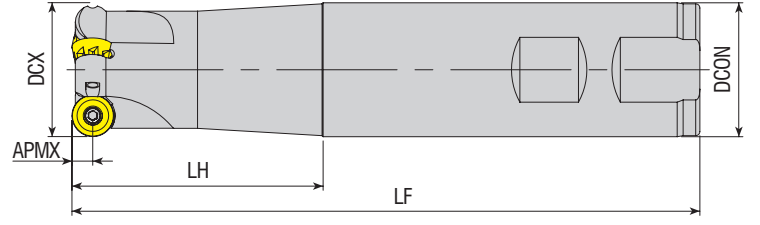

Takım Kodu Ordering Code Код для заказа	Stok Stock Наличие	Takım Ölçüleri (mm) Dimension (mm) Размеры (мм)						Kesici Uç Insert Пластина	Yedek Parçaları / Spare Parts / Запасные части			
		DCX	ZEP	DCON	LF	LH	APMX		Sıkma Vidası Screw Зажимной винт	Baskı Parçası Wedge Clamp Прижим	Baskı Vidası Clamp Screw Зажимной винт	Tork Anahtar Torx Key Торх Ключ
AEMR-RP10T3-D25-W25-L125-Z02	●	25	2	25	125	60	5	RPNX 10T3..	4010-M3x8	-	-	80-T10
AEMR-RP10T3-D25-W25-L150-Z02	●	25	2	25	150	60	5					
AEMR-RP10T3-D32-W32-L150-Z03	●	32	3	32	150	60	5					

CRTZT Ucuna Uygunur. / Compatible with CRTZT Insert. / Под пластину CRTZT

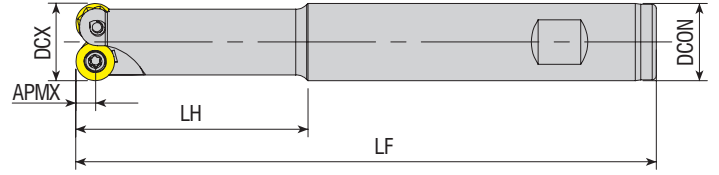

Takım Kodu Ordering Code Код для заказа	Stok Stock Наличие	Takım Ölçüleri (mm) Dimension (mm) Размеры (мм)						Kesici Uç Insert Пластина	Yedek Parçaları / Spare Parts / Запасные части		
		DCX	ZEP	DCON	LF	LH	APMX		Sıkma Vidası Screw Зажимной винт	Tork Anahtar Torx Key Торх Ключ	
AEMR-RY08-D16-W16-L150-Z02	●	16	2	16	150	55	4	RYMX 0803..	4010-M3x6	80-T10	
AEMR-RY10-D20-W20-L150-Z02	●	20	2	20	150	60	5	RYMX 1004..	4015-M3.5x8	80-T15	
AEMR-RY10-D20-C20-L200-Z02	●	20	2	20	200	100	5				
AEMR-RY10-D21-W20-L200-Z02-H	●	21	2	20	200	30	5				
AEMR-RY10-D25-W25-L150-Z02	●	25	2	25	150	60	5				
AEMR-RY10-D26-W25-L200-Z02-H	●	26	2	25	200	60	5				
AEMR-RY10-D32-W32-L160-Z04-H	●	32	4	32	160	60	5				
AEMR-RY12-D32-C25-L160-Z03	●	32	3	25	160	30	6				RYMX 1205..

R: Sağ / Right / Правый L: Sol / Left / Левый

● Stokta / In Stock / В наличии ○ Stokta Yok / Non Stock Item / Нет в наличии

TGTC Ucuna Uygunur. / Compatible with TGTC Insert. / Под пластину TGTC.

Sipariş Örneği/Ordering Example/Образец заказа

1 ad./pcs./шт. AEMR-RP10T3-D25-W25-L125-Z02

Kesme Hesabı : S 367 / Cutting Calculation : P 367 / Расчет режимов резания: стр. 367

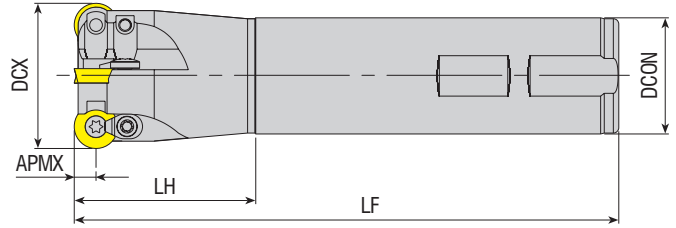

Takım Kodu
Ordering Code
Код для заказа

Takım Kodu Ordering Code Код для заказа	Stok Stock Наличие	Takım Ölçüleri (mm) Dimension (mm) Размеры (мм)						Kesici Uç Insert Пластина	Yedek Parçaları / Spare Parts / Запасные части					
		DCX	ZEFP	DCON	LF	LH	APMX		Sıkma Vidası Screw Зажимной винт	Baskı Parçası Wedge Clamp Прижим	Baskı Vidası Clamp Screw Зажимной винт	Tork Anahtar Torx Key Торк Ключ		
AEMR-RD0501-D08-W10-L100-Z01-H	●	8	1	10	100	20	2.5	RD.. 0501	3006-M2x3.6			80-T06		
AEMR-RD0501-D10-W12-L100-Z02-H	●	10	2	12	100	20	2.5		3006-M2x4					
AEMR-RD0501-D12-W12-L120-Z02-H	●	12	2	12	120	20	2.5							
AEMR-RD0803-D16-W16-L150-Z02	●	16	2	16	150	60	4	RD.. 0803	3008-M3x6	-	-	80-T08		
AEMR-RD0803-D16-C20-L200-Z02	●	16	2	20	200	60	4							
AEMR-RD0803-D20-W20-L150-Z03	●	20	3	20	150	60	4							
AEMR-RD08T2-D16-W16-L150-Z02	●	16	2	16	150	60	4	RD.. 08T2	3008-M2.5x6					
AEMR-RD08T2-D20-W20-L150-Z02	●	20	2	20	150	60	4							
AEMRC-RD1003-D20-W20-L150-Z02	●	20	2	20	150	60	5	RD.. 1003						
AEMRC-RD1003-D20-C20-L160-Z02	●	20	2	20	160	70	5							
AEMRC-RD1003-D20-C20-L250-Z02	●	20	2	20	250	150	5							
AEMRC-RD1003-D21-C20-L160-Z02	●	21	2	20	160	70	5							
AEMRC-RD1003-D25-W25-L150-Z02	●	25	2	25	150	60	5							
AEMRC-RD1003-D25-C25-L160-Z02	●	25	2	25	160	70	5							
AEMRC-RD1003-D25-W25-L200-Z02	●	25	2	25	200	100	5							
AEMRC-RD1003-D25-C25-L200-Z02	●	25	2	25	200	100	5							
AEMRC-RD1003-D25-C25-L250-Z02	●	25	2	25	250	150	5							
AEMRC-RD1003-D26-C25-L160-Z02	●	26	2	25	160	70	5							
AEMRC-RD1003-D32-W32-L150-Z03	●	32	3	32	150	60	5							
AEMRC-RD1003-D32-C32-L250-Z02	●	32	2	32	250	150	5							
AEMRC-RD1003-D33-C32-L160-Z03	●	33	3	32	160	70	5							
AEMRC-RD1003-D40-W32-L150-Z04	●	40	4	32	150	35	5							
AEMRC-RD1003-D40-C32-L250-Z02	●	40	2	32	250	50	5							
AEMRC-RD10T3-D20-C20-L150-Z02	●	20	2	20	150	60	5		RD.. 10T3	4015-M3.5x9	ACK-15		4015-M3.5x11	80-T15
AEMRC-RD10T3-D20-W20-L150-Z02	●	20	2	20	150	60	5							
AEMRC-RD10T3-D25-C25-L150-Z02	●	25	2	25	150	60	5							
AEMRC-RD10T3-D25-C25-L200-Z02-H	●	25	2	25	200	100	5							
AEMRC-RD10T3-D25-W25-L150-Z02	●	25	2	25	150	60	5							
AEMRC-RD10T3-D32-C25-L250-Z03-H	●	32	3	25	250	35	5							
AEMRC-RD10T3-D32-W32-L150-Z03	●	32	3	32	150	60	5							
AEMRC-RD12T3-D25-W25-L150-Z02	●	25	2	25	150	60	6	RD.. 12T3						
AEMRC-RD12T3-D25-W25-L200-Z02	●	25	2	25	200	100	6							
AEMRC-RD12T3-D25-C25-L250-Z02	●	25	2	25	250	150	6							
AEMRC-RD12T3-D25-C25-L300-Z02	●	25	2	25	300	200	6							
AEMRC-RD12T3-D32-W32-L150-Z03	●	32	3	32	150	60	6							
AEMRC-RD12T3-D32-C32-L250-Z02	●	32	2	32	250	150	6							
AEMRC-RD12T3-D40-W32-L150-Z04	●	40	4	32	150	50	6							
AEMRC-RD12T3-D40-C32-L250-Z02	●	40	2	32	250	50	6							
AEMRC-RD1204-D32-C32-L160-Z03	●	32	3	32	160	70	6	RD.. 1204						
AEMRC-RD1204-D32-W32-L160-Z03	●	32	3	32	160	70	6							
AEMRC-RD1204-D33-C32-L160-Z03	●	33	3	32	160	70	6							
AEMRC-RD1604-D40-W32-L150-Z02	●	40	2	32	150	35	8	RD.. 1604	4015-M4.5x11	ACK-05	4015-M4x11			

R: Sağ / Right / Правый L: Sol / Left / Левый

● Stokta / In Stock / В наличии ○ Stokta Yok / Non Stock Item / Нет в наличии
ISO Ucuna Uygunudur. / Compatible with ISO Insert. / Под пластину ISO.

Sipariş Örneği/Ordering Example/Образец заказа

1 ad./pcs./шт. AEMR-RD0501-D08-W10-L100-Z01-H

Kesme Hesabı : S 367 / Cutting Calculation : P 367 / Расчет режимов резания: стр. 367

S-SİSTEM YÜZEY ve KOPYA PARMAK FREZELER
S-SYSTEM FACE and COPY END MILLS
S-ТИП КОНЦЕВЫЕ РАДИУСНЫЕ ФРЕЗЫ

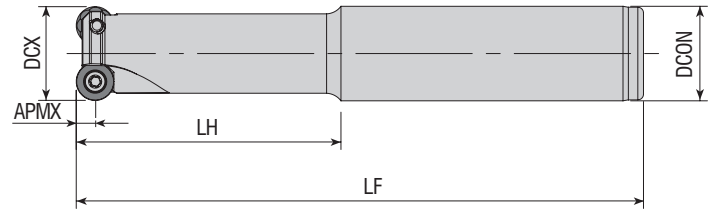

Takım Kodu Ordering Code Код для заказа	Stok Stock Наличие	Takım Ölçüleri (mm) Dimension (mm) Размеры (мм)						Kesici Uç Insert Пластина	Yedek Parçaları / Spare Parts / Запасные части			
		DCX	ZEP	DCON	LF	LH	APMX		Sıkma Vidası Screw Зажимной винт	Baskı Parçası Wedge Clamp Прижим	Baskı Vidası Clamp Screw Зажимной винт	Tork Anahtar Torx Key Торх Ключ
AEMR-QP10T3-D20-C20-L150-Z01-H	●	20	1	20	150	70	5	QP. 10T3..	4015-M3.5x9	-	-	80-T15
AEMR-QP10T3-D25-C25-L120-Z02-H	●	25	2	25	120	40	5					
AEMR-QP10T3-D25-C25-L150-Z02-H	●	25	2	25	150	70	5					
AEMR-QP10T3-D25-C25-L170-Z02	●	25	2	25	170	90	5					
AEMR-QP10T3-D32-C32-L150-Z03-H	●	32	3	32	150	70	5					
AEMR-QP10T3-D32-C32-L170-Z03	●	32	3	32	170	90	5					
AEMR-QP1204-D25-C25-L150-Z02-H	●	25	2	25	150	70	6	QP. 1204..	4015-M4x9	-	-	

SMTM Ucuna Uygundur. / Compatible with SMTM Insert. / Под пластину SMTM.

S-SİSTEM HIZLI İLERLEMELİ PARMAK FREZELER
S-SYSTEM HIGHFEED END MILLS
S-ТИП ВЫСОКОПРОИЗВОДИТЕЛЬНЫЕ КОНЦЕВЫЕ ФРЕЗЫ

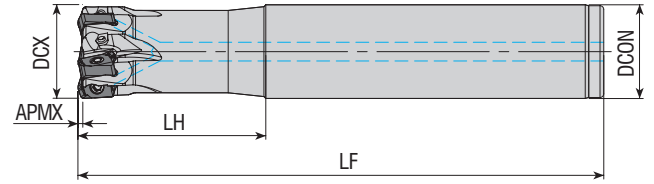

Takım Kodu Ordering Code Код для заказа	Stok Stock Наличие	Takım Ölçüleri (mm) Dimension (mm) Размеры (мм)						Kesici Uç Insert Пластина	Yedek Parçaları / Spare Parts / Запасные части	
		DCX	ZEP	DCON	LF	LH	APMX		Sıkma Vidası Screw Зажимной винт	Tork Anahtar Torx Key Торх Ключ
AHFM-BN10T3-D16-C16-L100-Z02-H	●	16	2	16	100	30	1	BNGX 10T3..	3008-M2.5x6	80-T08
AHFM-BN10T3-D16-C16-L150-Z02-H	●	16	2	16	150	50	1			
AHFM-BN10T3-D20-C20-L130-Z03-H	●	20	3	20	130	40	1			
AHFM-BN10T3-D20-C20-L130-Z04-H	●	20	4	20	130	40	1			
AHFM-BN10T3-D20-C20-L160-Z03-H	●	20	3	20	160	80	1			
AHFM-BN10T3-D25-C25-L140-Z04-H	●	25	4	25	140	50	1			
AHFM-BN10T3-D25-W25-L140-Z04-H	●	25	4	25	140	50	1			
AHFM-BN10T3-D25-C25-L140-Z05-H	●	25	5	25	140	50	1			
AHFM-BN10T3-D25-C25-L180-Z04-H	●	25	4	25	180	100	1			
AHFM-BN10T3-D32-C32-L150-Z05-H	●	32	5	32	150	70	1			
AHFM-BN10T3-D32-C32-L150-Z06-H	●	32	6	32	150	70	1			
AHFM-BN10T3-D35-C32-L200-Z06-H	●	35	6	32	200	50	1			

R: Sağ / Right / Правый L: Sol / Left / Левый

● Stokta / In Stock / В наличии ○ Stokta Yok / Non Stock Item / Нет в наличии

PRMT Ucuna Uygundur. / Compatible with PRMT Insert. / Под пластину PRMT.

Sipariş Örneği/Ordering Example/Образец заказа



1 ad./pcs./шт. AEMR-QP10T3-D20-C20-L150-Z01-H

Kesme Hesabı : S 367 / Cutting Calculation : P 367 / Расчет режимов резания: стр. 367



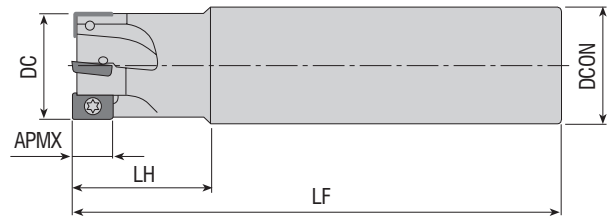

www.akko.com.tr

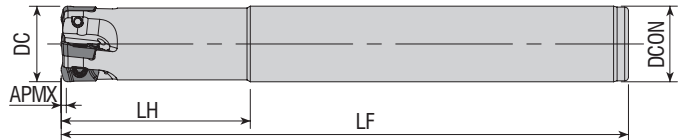

Takım Kodu Ordering Code Код для заказа	Stok Stock Наличие	Takım Ölçüleri (mm) Dimension (mm) Размеры (мм)						Kesici Uç Insert Пластина	Yedek Parçaları / Spare Parts / Запасные части		
		DC	ZEFP	DCON	LF	LH	APMX		Sikma Vidası Screw Зажимной винт	Tork Anahtar Torx Key Торх Ключ	
AHFM-E00602-D10-C10-L080-Z02	●	10	2	10	80	20	-	 EO.. 0602.. ZOMT 0602..	 3006-M1.8x4	 80-T06	
AHFM-E00602-D10-C09-L120-Z02	●	10	2	9	120	15	-				
AHFM-E00602-D10-C10-L120-Z02	●	10	2	10	120	60	-				
AHFM-E00602-D12-C12-L080-Z02	●	12	2	12	80	20	-				
AHFM-E00602-D12-C12-L080-Z03	●	12	3	12	80	20	-				
AHFM-E00602-D12-C11-L120-Z02	●	12	2	11	120	15	-				
AHFM-E00602-D12-C11-L120-Z03	●	12	3	11	120	15	-				
AHFM-E00602-D12-C12-L120-Z02	●	12	2	12	120	60	-				
AHFM-E00602-D12-C12-L120-Z03	●	12	3	12	120	60	-				
AHFM-E00602-D16-C16-L150-Z04	●	16	4	16	150	60	-				

DJT Ucuna Uygunudur. / Compatible with DJT Insert. / Под пластину SMTM-DJT

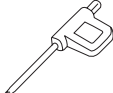

Takım Kodu Ordering Code Код для заказа	Stok Stock Наличие	Takım Ölçüleri (mm) Dimension (mm) Размеры (мм)						Kesici Uç Insert Пластина	Yedek Parçaları / Spare Parts / Запасные части		
		DC	ZEFP	DCON	LF	LH	APMX		Sikma Vidası Screw Зажимной винт	Tork Anahtar Torx Key Торх Ключ	
AHFM-EP1003-D16-C16-L150-Z02-H	●	16	2	16	150	50	1	 EP. 1003.. ZPMT 1003.. YPHW 1003..	 3008-M2.5x5	 80-T08	
AHFM-EP1003-D17-C16-L150-Z02-H	●	17	2	16	150	20	1				
AHFM-EP1003-D20-C20-L150-Z04-H	●	20	4	20	150	50	1				
AHFM-EP1003-D21-C20-L150-Z04-H	●	21	4	20	150	20	1				
AHFM-EP1003-D25-C25-L200-Z04-H	●	25	4	25	200	100	1				
AHFM-EP1003-D25-C25-L250-Z04-H	●	25	4	25	250	100	1				

R: Sağ / Right / Правый L: Sol / Left / Левый
● Stokta / In Stock / В наличии ○ Stokta Yok / Non Stock Item / Нет в наличии
DJT Ucuna Uygunudur. / Compatible with DJT Insert. / Под пластину SMTM-DJT

Sipariş Örneği/Ordering Example/Образец заказа
1 ad./pcs./шт. AHFM-E00602-D10-C10-L080-Z02
Kesme Hesabı : S 367 / Cutting Calculation : P 367 / Расчет режимов резания: стр. 367

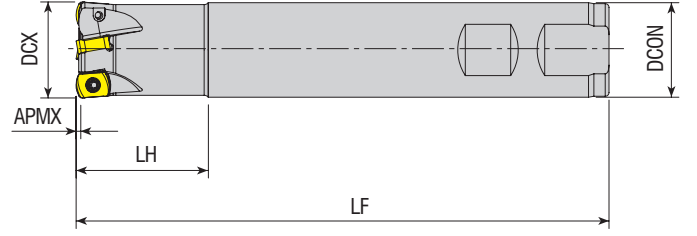

Takım Kodu Ordering Code Код для заказа	Stok Stock Наличие	Takım Ölçüleri (mm) Dimension (mm) Размеры (мм)						Kesici Uç Insert Пластина	Yedek Parçaları / Spare Parts / Запасные части		
		DCX	ZEFP	DCON	LF	LH	APMX		Sıkma Vidası Screw Зажимной винт	Tork Anahtar Torx Key Торх Ключ	
AHFM-BL0603-D16-C15-L150-Z02	●	16	2	15	150	20	1	BLMP 0603..	3008-M2.5x6	80-T08	
AHFM-BL0603-D16-C16-L100-Z02-H	●	16	2	16	100	30	1				
AHFM-BL0603-D16-C16-L150-Z02	●	16	2	16	150	50	1				
AHFM-BL0603-D17-C16-L150-Z02	●	17	2	16	150	20	1				
AHFM-BL0603-D17-W16-L170-Z02	●	17	2	16	170	20	1				
AHFM-BL0603-D17-W16-L170-Z02-H	●	17	2	16	170	20	1				
AHFM-BL0603-D17-C16-L200-Z02	●	17	2	16	200	30	1				
AHFM-BL0603-D18-C16-L150-Z02	●	18	2	16	150	20	1				
AHFM-BL0603-D18-W16-L150-Z02-H	●	18	2	16	150	20	1				
AHFM-BL0603-D20-C20-L130-Z03	●	20	3	20	130	50	1				
AHFM-BL0603-D20-C20-L160-Z03	●	20	3	20	160	50	1				
AHFM-BL0603-D21-C20-L200-Z03	●	21	3	20	200	25	1				
AHFM-BL0603-D21-W20-L200-Z03	●	21	3	20	200	25	1				
AHFM-BL0603-D22-W20-L150-Z03	●	22	3	20	150	20	1				
AHFM-BL0603-D25-C25-L250-Z04	●	25	4	25	250	40	1				
AHFM-BL0603-D26-C25-L200-Z04	●	26	4	25	200	35	1				
AHFM-BL0603-D26-W25-L200-Z04	●	26	4	25	200	35	1				
AHFM-BL0603-D26-C25-L250-Z04	●	26	4	25	250	35	1				
AHFM-BL0603-D32-C32-L150-Z05	●	32	5	32	150	70	1				
AHFM-BL0603-D32-C32-L200-Z05	●	32	5	32	200	120	1				
AHFM-BL0603-D33-C32-L150-Z05	●	33	5	32	150	40	1				
AHFM-BL0603-D33-C32-L200-Z05	●	33	5	32	200	40	1				
AHFM-BL0603-D33-C32-L250-Z05	●	33	5	32	250	40	1				

R: Sağ / Right / Правый L: Sol / Left / Левый
● Stokta / In Stock / В наличии ○ Stokta Yok / Non Stock Item / Нет в наличии
TGTC Uçuna Uygun. / Compatible with TGTC Insert. / Под пластину TGTC.

Sipariş Örneği/Ordering Example/Образец заказа
1 ad./pcs./шт. AHFM-BL0603-D16-C15-L150-Z02
Kesme Hesabı : S 367 / Cutting Calculation : P 367 / Расчет режимов резания: стр. 367

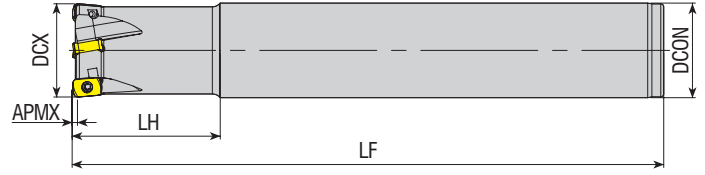

Takım Kodu Ordering Code Код для заказа	Stok Stock Наличие	Takım Ölçüleri (mm) Dimension (mm) Размеры (мм)						Kesici Uç Insert Пластина	Yedek Parçaları / Spare Parts / Запасные части		
		DCX	ZEPF	DCON	LF	LH	APMX		Sikma Vidası Screw Зажимной винт	Tork Anahtar Torx Key Торх Ключ	
AHFM-EN1004-D16-C15-L150-Z02	●	16	2	15	150	25	1	ENMU 1004..	3008-M2.5x6	80-T08	
AHFM-EN1004-D16-C16-L150-Z02	●	16	2	16	150	25	1				
AHFM-EN1004-D16-C16-L250-Z02	●	16	2	16	250	70	1				
AHFM-EN1004-D17-C16-L150-Z02-H	●	17	2	16	150	25	1				
AHFM-EN1004-D17-C16-L150-Z02	●	17	2	16	150	25	1				
AHFM-EN1004-D17-C16-L200-Z02	●	17	2	16	200	25	1				
AHFM-EN1004-D18-C16-L150-Z02	●	18	2	16	150	25	1				
AHFM-EN1004-D20-C20-L150-Z03	●	20	3	20	150	40	1				
AHFM-EN1004-D20-C20-L250-Z03	●	20	3	20	250	70	1				
AHFM-EN1004-D21-C20-L150-Z02	●	21	2	20	150	30	1				
AHFM-EN1004-D21-C20-L150-Z03	●	21	3	20	150	30	1				
AHFM-EN1004-D21-C20-L150-Z03-H	●	21	3	20	150	30	1				
AHFM-EN1004-D21-C20-L200-Z03	●	21	3	20	200	30	1				
AHFM-EN1004-D22-C20-L150-Z03	●	22	3	20	150	30	1				
AHFM-EN1004-D25-C25-L150-Z03	●	25	3	25	150	40	1				
AHFM-EN1004-D25-C25-L150-Z04	●	25	4	25	150	40	1				
AHFM-EN1004-D26-C25-L150-Z03	●	26	3	25	150	30	1				
AHFM-EN1004-D26-C25-L150-Z04	●	26	4	25	150	30	1				
AHFM-EN1004-D26-C25-L200-Z03	●	26	3	25	150	30	1				
AHFM-EN1004-D26-C25-L200-Z03-H	●	26	3	25	200	30	1				
AHFM-EN1004-D26-C25-L250-Z03-H	●	26	3	25	250	30	1				
AHFM-EN1004-D28-C25-L200-Z04	●	28	4	25	200	30	1				
AHFM-EN1004-D32-C32-L200-Z04	●	32	4	32	200	50	1				
AHFM-EN1004-D33-C32-L200-Z04	●	33	4	32	200	30	1				
AHFM-EN1004-D33-C32-L200-Z04-H	●	33	4	32	200	30	1				

R: Sağ / Right / Правый L: Sol / Left / Левый

● Stokta / In Stock / В наличии ○ Stokta Yok / Non Stock Item / Нет в наличии

DJT Ucuna Uygundur. / Compatiple with DJT Insert. / Под пластину SMTM-DJT

Sipariş Örneği/Ordering Example/Образец заказа

1 ad./pcs./шт. AHFM-EN1004-D16-C15-L150-Z02

Kesme Hesabı : S 367 / Cutting Calculation : P 367 / Расчет режимов резания: стр. 367



S-SİSTEM HIZLI İLERLEMELİ PARMAK FREZELER
S-SYSTEM HIGHFEED END MILLS
S-ТИП ВЫСОКОПРОИЗВОДИТЕЛЬНЫЕ КОНЦЕВЫЕ ФРЕЗЫ

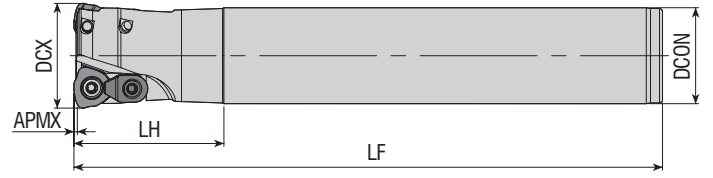

Takım Kodu Ordering Code Код для заказа	Stok Stock Наличие	Takım Ölçüleri (mm) Dimension (mm) Размеры (мм)						Kesici Uç Insert Пластина	Yedek Parçaları / Spare Parts / Запасные части			
		DCX	ZEPF	DCON	LF	LH	APMX		Sıkma Vidası Screw Зажимной винт	Baskı Parçası Wedge Clamp Прижим	Baskı Vidası Clamp Screw Зажимной винт	Tork Anahtar Torx Key Торх Ключ
AHFMC-JD1204-D32-C32-L150-Z02	●	32	2	32	150	50	1	JDMW 1204..	4615-M4x11	ACK-05	4015-M4x11	80-T15
AHFMC-JD1204-D32-C32-L200-Z02	●	32	2	32	200	50	1					
AHFMC-JD1204-D35-C32-L200-Z02	●	35	2	32	200	50	1					
AHFMC-JD1204-D35-C32-L250-Z02	●	35	2	32	250	50	1					

MTSBH Ucuna Uygundur. / Compatiple with MTSBHInsert. / Под пластину MTSBH.

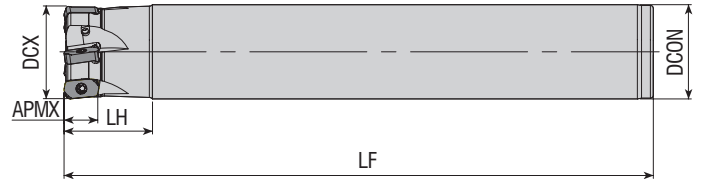

Takım Kodu Ordering Code Код для заказа	Stok Stock Наличие	Takım Ölçüleri (mm) Dimension (mm) Размеры (мм)						Kesici Uç Insert Пластина	Yedek Parçaları / Spare Parts / Запасные части	
		DCX	ZEPF	DCON	LF	LH	APMX		Sıkma Vidası Screw Зажимной винт	Tork Anahtar Torx Key Торх Ключ
AHFM-LN0303-D16-C15-L150-Z02	●	16	2	15	150	30	12	LNMU 0303..	3008-M2.5x6	80-T08
AHFM-LN0303-D16-W16-L150-Z02-H	●	16	2	16	150	50	12			
AHFM-LN0303-D20-W20-L150-Z03-H	●	20	3	20	150	50	12			
AHFM-LN0303-D21-C20-L150-Z03	●	21	3	20	150	30	12			
AHFM-LN0303-D25-W25-L150-Z04-H	●	25	4	25	150	50	12			
AHFM-LN0303-D26-C25-L150-Z04	●	26	4	25	150	30	12			
AHFM-LN0303-D33-C32-L200-Z05	●	33	5	32	200	30	12			

R: Sağ / Right / Правый L: Sol / Left / Левый

● Stokta / In Stock / В наличии ○ Stokta Yok / Non Stock Item / Нет в наличии

TNGLY Ucuna Uygundur. / Compatiple with TNGLY Insert. / Под пластину TNGLY.

Sipariş Örneği/Ordering Example/Образец заказа

1 ad./pcs./шт. AHFMC-JD1204-D32-C32-L150-Z02

Kesme Hesabı : S 367 / Cutting Calculation : P 367 / Расчет режимов резания: стр. 367

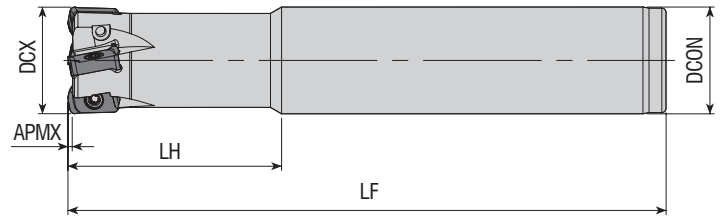

Takım Kodu Ordering Code Код для заказа	Stok Stock Наличие	Takım Ölçüleri (mm) Dimension (mm) Размеры (мм)						Kesici Uç Insert Пластина	Yedek Parçaları / Spare Parts / Залпасные части		
		DCX	ZEFP	DCON	LF	LH	APMX		Sikma Vidası Screw Зажимной винт	Tork Anahtar Torx Key Торх Ключ	
AHFM-L003-D16-C15-L160-Z02	●	16	2	15	160	30	1	LOGU 0303..	1108-M3x6.8	80-T08	
AHFM-L003-D16-C16-L100-Z02-F	●	16	2	16	100	30	1				
AHFM-L003-D16-C16-L100-Z02	●	16	2	16	100	30	1				
AHFM-L003-D16-C16-L130-Z02-H	●	16	2	16	130	40	1				
AHFM-L003-D16-C16-L160-Z02	●	16	2	16	160	50	1				
AHFM-L003-D16-C16-L160-Z02-H	●	16	2	16	160	100	1				
AHFM-L003-D17-C16-L180-Z02	●	17	2	16	180	30	1				
AHFM-L003-D20-C20-L130-Z03	●	20	3	20	130	40	1				
AHFM-L003-D20-C20-L130-Z03-H	●	20	3	20	130	40	1				
AHFM-L003-D20-C20-L160-Z03	●	20	3	20	160	80	1				
AHFM-L003-D20-C20-L160-Z03-H	●	20	3	20	160	100	1				
AHFM-L003-D21-C20-L150-Z03-H	●	21	3	20	150	30	1				
AHFM-L003-D21-C20-L200-Z03	●	21	3	20	200	30	1				
AHFM-L003-D21-C20-L200-Z03-H	●	21	3	20	200	30	1				
AHFM-L003-D25-C25-L140-Z04-F	●	25	4	25	140	50	1				
AHFM-L003-D25-C25-L140-Z04	●	25	4	25	140	50	1				
AHFM-L003-D25-C25-L180-Z04	●	25	4	25	180	100	1				
AHFM-L003-D26-C25-L250-Z04	●	26	4	25	250	40	1				
AHFM-L003-D32-C32-L200-Z05	●	32	5	32	200	120	1				
AHFM-L003-D33-C32-L250-Z05	●	33	5	32	250	40	1				

R: Sağ / Right / Правый L: Sol / Left / Левый

● Stokta / In Stock / В наличии ○ Stokta Yok / Non Stock Item / Нет в наличии

KYCR Ucuna Uygundur. / Compatible with KYCR Insert. / Под пластину KYCR

F: Eksenel ve Radyal Salgı Değeri 0,02 mm içindedir. / F: Axial and Radial Runout Value is within 0,02 mm.

F: значение радиального и осевого биения в пределах 0,02 мм.

Sipariş Örneği/Ordering Example/Образец заказа

1 ad./pcs./шт. AHFM-L003-D16-C15-L160-Z02

Kesme Hesabı : S 367 / Cutting Calculation : P 367 / Расчет режимов резания: стр. 367

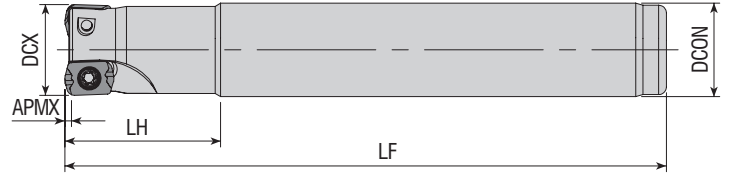

Takım Kodu Ordering Code Код для заказа	Stok Stock Наличие	Takım Ölçüleri (mm) Dimension (mm) Размеры (мм)						Kesici Uç Insert Пластина	Yedek Parçaları / Spare Parts / Запасные части		
		DCX	ZEPF	DCON	LF	LH	APMX		Sıkma Vidası Screw Зажимной винт	Tork Anahtar Torx Key Торх Ключ	
AHFM-LP0102-D10-C09-L120-Z02	●	10	2	9	120	20	0.5	LPGT 0102..		3006-M1.8x4	
AHFM-LP0102-D10-C10-L120-Z02	●	10	2	10	120	20	0.5				
AHFM-LP0102-D12-C11-L120-Z02	●	12	2	11	120	20	0.5				
AHFM-LP0102-D12-C12-L120-Z02	●	12	2	12	120	20	0.5				

KYCR Ucuna Uygunur. / Compatiple with KYCR Insert. / Под пластины KYCR

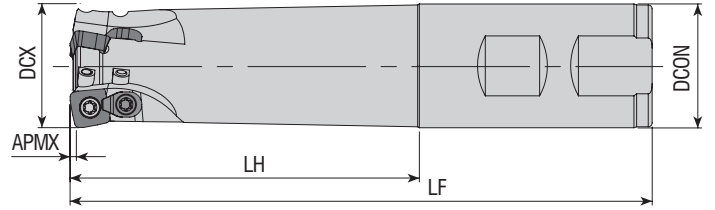

Takım Kodu Ordering Code Код для заказа	Stok Stock Наличие	Takım Ölçüleri (mm) Dimension (mm) Размеры (мм)						Kesici Uç Insert Пластина	Yedek Parçaları / Spare Parts / Запасные части			
		DCX	ZEPF	DCON	LF	LH	APMX		Sıkma Vidası Screw Зажимной винт	Baskı Parçası Wedge Clamp Прижим	Baskı Vidası Clamp Screw Зажимной винт	Tork Anahtar Torx Key Торх Ключ
AHFM-SD06T2-D16-C16-L100-Z02-H	●	16	2	16	100	50	0.8	SD.. 06T2..	3007-M2.2x5	-	-	80-T07
AHFM-SD06T2-D16-C16-L150-Z02-H	●	16	2	16	150	50	0.8					
AHFM-SD06T2-D16-C16-L200-Z02	●	16	2	16	200	100	0.8					
AHFM-SD06T2-D17-C16-L150-Z02-H	●	17	2	16	150	50	0.8					
AHFM-SD06T2-D20-C20-L150-Z03-H	●	20	3	20	150	50	0.8					
AHFM-SD06T2-D20-C20-L200-Z03	●	20	3	20	200	100	0.8					
AHFM-SD06T2-D21-C20-L150-Z03-H	●	21	3	20	150	50	0.8					
AHFM-SD06T2-D25-C25-L150-Z04-H	●	25	4	25	150	60	0.8					
AHFM-SD06T2-D26-C25-L150-Z04-H	●	26	4	25	150	60	0.8					
AHFM-SD06T2-D26-C25-L150-Z04-H	●	26	4	25	150	60	0.8					
AHFMC-SD09T3-D22-W20-L150-Z02	●	22	2	20	150	30	1.4	SD.. 09T3..	3010-M3.5x9	ACK-15	1510-M3.5x9	80-T10
AHFMC-SD09T3-D25-C25-L150-Z02	●	25	2	25	150	94	1.4					
AHFMC-SD09T3-D25-W25-L150-Z02	●	25	2	25	150	94	1.4					
AHFMC-SD09T3-D28-C25-L150-Z02	●	28	2	25	150	30	1.4					
AHFMC-SD09T3-D32-C32-L150-Z03	●	32	3	32	150	100	1.4					
AHFMC-SD09T3-D32-W32-L150-Z03	●	32	3	32	150	90	1.4					
AHFMC-SD09T3-D25-C25-L150-Z03	●	25	3	25	150	60	1.4					
AHFMC-SD09T3-D32-C32-L150-Z04	●	32	4	25	150	60	1.4					
AHFMC-SD09T3-D32-C32-L150-Z04	●	32	4	25	150	60	1.4					
AHFMC-SD09T3-D32-C32-L150-Z04	●	32	4	25	150	60	1.4					

R: Sağ / Right / Правый L: Sol / Left / Левый

● Stokta / In Stock / В наличии ○ Stokta Yok / Non Stock Item / Нет в наличии

ZCC Ucuna Uygunur. / Compatiple with ZCC Insert. / Под пластины ZCC

Sipariş Örneği/Ordering Example/Образец заказа

1 ad./pcs./шт. AHFM-LP0102-D10-C09-L120-Z02

Kesme Hesabı : S 367 / Cutting Calculation : P 367 / Расчет режимов резания: стр. 367

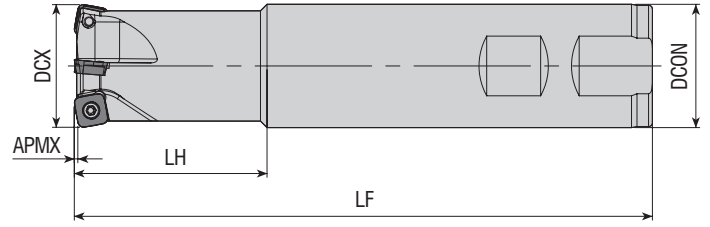

Takım Kodu Ordering Code Код для заказа	Stok Stock Наличие	Takım Ölçüleri (mm) Dimension (mm) Размеры (мм)						Kesici Uç Insert Пластина	Yedek Parçaları / Spare Parts / Запасные части	
		DCX	ZEFP	DCON	LF	LH	APMX		Sıkma Vidası Screw Зажимной винт	Tork Anahtar Torx Key Торх Ключ
AHFM-S00803-D20-W20-L150-Z02	●	20	2	20	150	50	-			
AHFM-S00803-D25-W25-L150-Z03	●	25	3	25	150	50	-			
AHFM-S00803-D32-W32-L150-Z04	●	32	4	32	150	50	-			

KPTK Ucuna Uygun. / Compatible with KPTK Insert. / Под пластину KPTK

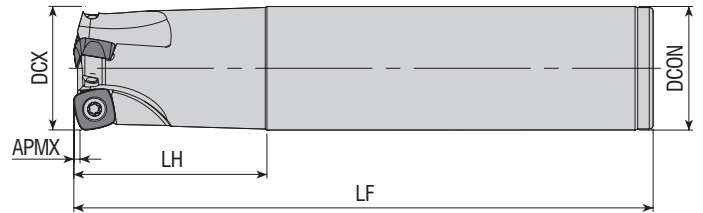

Takım Kodu Ordering Code Код для заказа	Stok Stock Наличие	Takım Ölçüleri (mm) Dimension (mm) Размеры (мм)						Kesici Uç Insert Пластина	Yedek Parçaları / Spare Parts / Запасные части	
		DCX	ZEFP	DCON	LF	LH	APMX		Sıkma Vidası Screw Зажимной винт	Tork Anahtar Torx Key Торх Ключ
AHFM-SP1004-D25-C25-L150-Z02	●	25	2	25	150	50	1.5			
AHFM-SP1004-D32-C32-L150-Z03	●	32	3	32	150	50	1.5			

R: Sağ / Right / Правый L: Sol / Left / Левый



● Stokta / In Stock / В наличии ○ Stokta Yok / Non Stock Item / Нет в наличии
DJT Ucuna Uygun. / Compatible with DJT Insert. / Под пластину SMTM-DJT

Sipariş Örneği/Ordering Example/Образец заказа

1 ad./pcs./шт. AHFM-S00803-D20-W20-L150-Z02

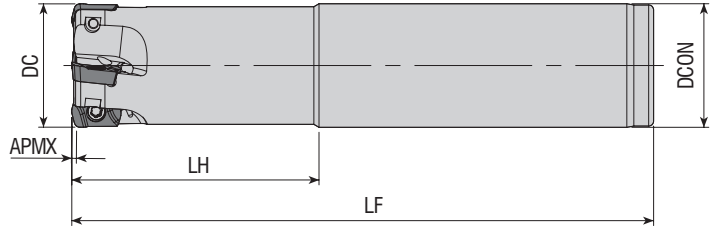
Kesme Hesabı : S 367 / Cutting Calculation : P 367 / Расчет режимов резания: стр. 367



Takım Kodu Ordering Code Код для заказа	Stok Stock Наличие	Takım Ölçüleri (mm) Dimension (mm) Размеры (мм)						Kesici Uç Insert Пластина	Yedek Parçaları / Spare Parts / Запасные части	
		DC	ZEFP	DCON	LF	LH	APMX		Sıkma Vidası Screw Зажимной винт	Tork Anahtar Torx Key Торх Ключ
AHFM-YP1003-D16-C15-L150-Z02-F	●	16	2	15	150	20	1	 EP. 1003.. YPHW 1003.. ZPMT 1003..	 3008-M2.5x5	 80-T08
AHFM-YP1003-D16-C15-L200-Z02-F	●	16	2	15	200	20	1			
AHFM-YP1003-D16-C16-L150-Z02-F	●	16	2	16	150	50	1			
AHFM-YP1003-D17-C16-L150-Z02-F	●	17	2	16	150	20	1			
AHFM-YP1003-D17-C16-L200-Z02-F	●	17	2	16	200	20	1			
AHFM-YP1003-D20-C18-L150-Z03-F	●	20	3	18	150	25	1			
AHFM-YP1003-D20-C18-L200-Z03-F	●	20	3	18	200	25	1			
AHFM-YP1003-D20-C20-L150-Z03-F	●	20	3	20	150	50	1			
AHFM-YP1003-D21-C20-L150-Z03-F	●	21	3	20	150	20	1			
AHFM-YP1003-D21-C20-L150-Z03-H	●	21	3	20	150	20	1			
AHFM-YP1003-D21-C20-L150-Z04-F	●	21	4	20	150	20	1			
AHFM-YP1003-D21-C20-L200-Z03	●	21	3	20	200	20	1			
AHFM-YP1003-D21-C20-L200-Z03-F	●	21	3	20	200	20	1			
AHFM-YP1003-D25-C20-L150-Z04-F	●	25	4	20	150	25	1			
AHFM-YP1003-D25-C20-L200-Z04-F	●	25	4	20	200	25	1			
AHFM-YP1003-D25-C25-L150-Z04-F	●	25	4	25	150	50	1			
AHFM-YP1003-D26-C25-L150-Z04	●	26	4	25	150	30	1			
AHFM-YP1003-D26-C25-L150-Z04-F	●	26	4	25	150	30	1			
AHFM-YP1003-D26-C25-L200-Z03-F	●	26	3	25	200	30	1			
AHFM-YP1003-D26-C25-L200-Z04-F	●	26	4	25	200	30	1			

R: Sağ / Right / Правый L: Sol / Left / Левый

● Stokta / In Stock / В наличии ○ Stokta Yok / Non Stock Item / Нет в наличии

DJT Ucuna Uygunudur. / Compatible with DJT Insert. / Под пластину SMTM-DJT

Çap Ölçüsü - 0,02 mm Olarak üretiliyor. F: ± 0,02 mm Demektir. Ör: Ø16 Takım 15,98 ± 0,02 mm yani 16,00 mm - 15,96 mm Olmalıdır.

Diameter Size is produced as - 0.02 mm. F: means ± 0,02 mm. For example: Ø16 tool 15.98 ± 0,02 mm, it means that it should be 16,00 mm - 15,96 mm.

Размер диаметра составляет -0,02 мм. F: означает ± 0,02 мм. Например: Ø16 инструмент 15,98 ± 0,02 мм, должно быть 16,00мм -15,96 мм.

Sipariş Örneği/Ordering Example/Образец заказа

1 ad./pcs./шт. AHFM-YP1003-D16-C15-L150-Z02-F

Kesme Hesabı : S 367 / Cutting Calculation : P 367 / Расчет режимов резания: стр. 367



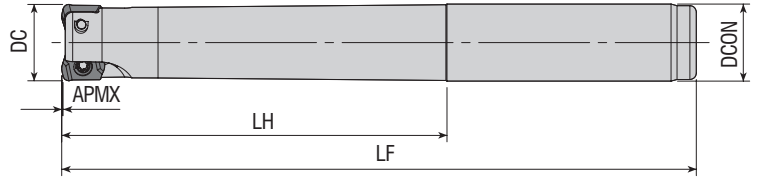

Takım Kodu Ordering Code Код для заказа	Stok Stock Наличие	Takım Ölçüleri (mm) Dimension (mm) Размеры (мм)						Kesici Uç Insert Пластина	Yedek Parçaları / Spare Parts / Запасные части		
		DC	ZEPF	DCON	LF	LH	APMX		Sikma Vidası Screw Зажимной винт	Tork Anahtar Torx Key Торх Ключ	
AHFM-Y00602-D10-C09-L120-Z02-F	●	10	2	9	120	15	0.3	Y0HW 0602..	3006-M1.8X4	80-T06	
AHFM-Y00602-D10-C10-L080-Z02-F	●	10	2	10	80	20	0.3				
AHFM-Y00602-D10-C10-L120-Z02-F	●	10	2	10	120	60	0.3				
AHFM-Y00602-D10-C10-L120-Z02-H-F	●	10	2	10	120	60	0.3				
AHFM-Y00602-D10-C10-L120-Z02-H	●	10	2	10	120	60	0.3				
AHFM-Y00602-D12-C11-L120-Z02-F	●	12	2	11	120	15	0.3				
AHFM-Y00602-D12-C11-L120-Z02-H-F	●	12	2	11	120	15	0.3				
AHFM-Y00602-D12-C11-L120-Z02-H	●	12	2	11	120	15	0.3				
AHFM-Y00602-D12-C11-L120-Z03-F	●	12	3	11	120	15	0.3				
AHFM-Y00602-D12-C12-L080-Z02-F	●	12	2	12	80	20	0.3				
AHFM-Y00602-D12-C12-L080-Z03-F	●	12	3	12	80	20	0.3				
AHFM-Y00602-D12-C12-L120-Z02-F	●	12	2	12	120	60	0.3				
AHFM-Y00602-D12-C12-L120-Z02-H	●	12	2	12	120	60	0.3				
AHFM-Y00602-D12-C12-L120-Z03-F	●	12	3	12	120	60	0.3				
AHFM-Y00602-D12-C12-L120-Z03-H	●	12	3	12	120	60	0.3				

DJT Ucuna Uygundur. / Compatible with DJT Insert. / Под пластину SMTM-DJT

F: Eksenel ve Radyal Salgi Değeri 0,02 mm içindedir. / F: Axial and radial runout value is within 0,02mm / F: значение радиального и осевого биения в пределах 0,02 мм.

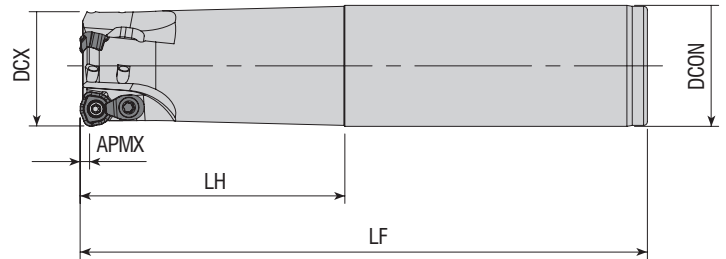

Takım Kodu Ordering Code Код для заказа	Stok Stock Наличие	Takım Ölçüleri (mm) Dimension (mm) Размеры (мм)						Kesici Uç Insert Пластина	Yedek Parçaları / Spare Parts / Запасные части			
		DCX	ZEPF	DCON	LF	LH	APMX		Sikma Vidası Screw Зажимной винт	Baskı Parçası Wedge Clamp Прижим	Baskı Vidası Clamp Screw Зажимной винт	Tork Anahtar Torx Key Торх Ключ
AHFM-WD0603-D16-C16-L150-Z02	●	16	2	16	150	70	2	WDMT 0603..	3008-M2.5x6	-	-	80-T08
AHFM-WD0603-D20-C20-L150-Z03	●	20	3	20	150	70	2	WDMT 0603..	3008-M2.5x6	-	-	80-T08
AHFMC-WD0804-D25-C25-L150-Z02	●	25	2	25	150	70	1.5	WDMT 0804..	4010-M3X8	ACK-15	4010-M3x8	80-T10
AHFMC-WD0804-D32-C32-L150-Z03	●	32	3	32	150	70	1.5	WDMT 0804..	4010-M3X8	ACK-15	4010-M3x8	80-T10
AHFMC-WD1205-D32-C32-L150-Z02	●	32	2	32	150	70	3	WDMT 1205..	1415-M4x11	ACK-05	4015-M4x11	80-T15

R: Sağ / Right / Правый L: Sol / Left / Левый

● Stokta / In Stock / В наличии ○ Stokta Yok / Non Stock Item / Нет в наличии

SMTM Ucuna Uygundur. / Compatible with SMTM Insert. / Под пластину SMTM.

Sipariş Örneği/Ordering Example/Образец заказа

1 ad./pcs./шт. AHFM-Y00602-D10-C09-L120-Z02-F

Kesme Hesabı : S 367 / Cutting Calculation : P 367 / Расчет режимов резания: стр. 367

S-SİSTEM HIZLI İLERLEMELİ PARMAK FREZELER
S-SYSTEM HIGHFEED END MILLS
S-ТИП ВЫСОКОПРОИЗВОДИТЕЛЬНЫЕ КОНЦЕВЫЕ ФРЕЗЫ

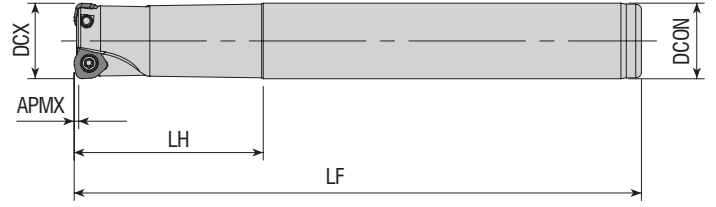

Takım Kodu Ordering Code Код для заказа	Stok Stock Наличие	Takım Ölçüleri (mm) Dimension (mm) Размеры (мм)						Kesici Uç Insert Пластина	Yedek Parçaları / Spare Parts / Запасные части			
		DCX	ZEP	DCON	LF	LH	APMX		Sıkma Vidası Screw Зажимной винт	Baskı Parçası Wedge Clamp Прижим	Baskı Vidası Clamp Screw Зажимной винт	Tork Anahtar Torx Key Торх Ключ
AHFM-WD0503D-D20-C20-L150-Z02	●	20	2	20	150	50	1.25	WD.W 0503..	4010-M3x6	-	-	80-T10
AHFM-WD0503D-D21-C20-L150-Z02	●	21	2	20	150	30	1.25					
AHFMC-WD06T3D-D26-C25-L200-Z02	●	26	2	25	200	30	1.5	WD.W 06T3..	3015-M3.5x9	ACK-15	4015-M3.5x11	80-T15
AHFMC-WD06T3D-D33-C32-L200-Z03	●	33	3	32	200	32	1.5					

DJT Ucuna Uygundur. / Compatible with DJT Insert. / Под пластину SMTM-DJT

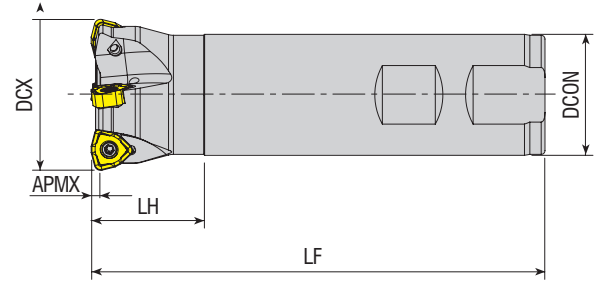

Takım Kodu Ordering Code Код для заказа	Stok Stock Наличие	Takım Ölçüleri (mm) Dimension (mm) Размеры (мм)						Kesici Uç Insert Пластина	Yedek Parçaları / Spare Parts / Запасные части	
		DCX	ZEP	DCON	LF	LH	APMX		Sıkma Vidası Screw Зажимной винт	Tork Anahtar Torx Key Торх Ключ
AHFM-WN0603-D16-C16-L110-Z02-H	●	16	2	16	110	30	1	WNMX 0603..	3008-M2.5x6	80-T08
AHFM-WN0603-D16-C16-L150-Z02-H	●	16	2	16	150	70	1			
AHFM-WN0603-D17-C16-L150-Z02-H	●	17	2	16	150	20	1			
AHFM-WN0603-D20-C20-L150-Z02-H	●	20	2	20	150	70	1			
AHFM-WN0603-D20-C20-L200-Z02-H	●	20	2	20	200	100	1			
AHFM-WN0603-D21-C20-L150-Z02-H	●	21	2	20	150	20	1	WNMX 09T3..	4010-M3x8	80-T10
AHFM-WN09T3-D25-W25-L120-Z02-H	●	25	2	25	120	40	1.5			
AHFML-WN09T3-D25-W25-L120-Z02-H	●	25	2	25	120	40	1.5			
AHFM-WN09T3-D25-C25-L200-Z02	●	25	2	25	200	120	1.5			
AHFM-WN09T3-D32-W32-L120-Z03-H	●	32	3	32	120	30	1.5			
AHFM-WN09T3-D32-W32-L200-Z03-H	○	32	3	32	200	100	1.5			
AHFM-WN09T3-D35-W32-L200-Z04-H	●	35	4	32	200	50	1.5			
AHFM-WN09T3-D40-W32-L120-Z04-H	●	40	4	32	120	30	1.5			
AHFM-WN09T3-D40-C32-L200-Z04	●	40	4	32	200	30	1.5			
AHFM-WN1305-D32-C32-L150-Z02-H	○	32	2	32	150	70	2			
AHFM-WN1305-D32-C32-L200-Z02-H	●	32	2	32	200	120	2			
AHFM-WN1305-D40-C32-L200-Z03-H	●	40	3	32	200	30	2			

R: Sağ / Right / Правый L: Sol / Left / Левый
 ● Stokta / In Stock / В наличии ○ Stokta Yok / Non Stock Item / Нет в наличии
 KRYL Ucuna Uygundur. / Compatible with KRYL Insert. / Под пластину KRLY

Sipariş Örneği/Ordering Example/Образец заказа
 1 ad./pcs./шт. AHFM-WD0503D-D20-C20-L150-Z02
 Kesme Hesabı : S 367 / Cutting Calculation : P 367 / Расчет режимов резания: стр. 367



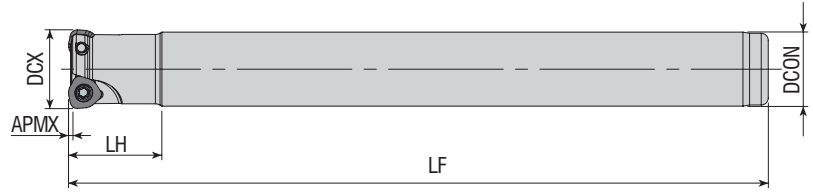

Takım Kodu Ordering Code Код для заказа	Stok Stock Наличие	Takım Ölçüleri (mm) Dimension (mm) Размеры (мм)						Kesici Uç Insert Пластина	Yedek Parçaları / Spare Parts / Запасные части		
		DCX	ZEPF	DCON	LF	LH	APMX		Sıkma Vidası Screw Зажимной винт	Tork Anahtar Torx Key Торх Ключ	
AHFM-W004T2D-D16-C16-L150-Z02	●	16	2	16	150	20	0.8	WOMW 04T2..	3008-M2.5x6	80-T08	
AHFM-W004T2D-D17-C16-L150-Z02	●	17	2	16	150	20	0.8				

DJT Ucuna Uygunudur. / Compatible with DJT Insert. / Под пластину SMTM-DJT

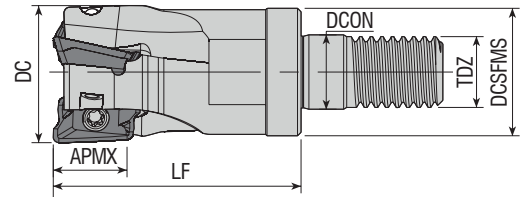

Takım Kodu Ordering Code Код для заказа	Stok Stock Наличие	Takım Ölçüleri (mm) Dimension (mm) Размеры (мм)							Kesici Uç Insert Пластина	Yedek Parçaları / Spare Parts / Запасные части		
		DC	Z	DCSFMS	TDZ	LF	DCON	APMX		Sıkma Vidası Screw Зажимной винт	Tork Anahtar Torx Key Торх Ключ	
AEM90-A01236-D16-M08-L30-Z02	●	16	2	14.8	M08	30	8.5	10	AO.. 1236..	3008-M2.5x6	80-T08	
AEM90-A01236-D20-M10-L35-Z03	●	20	3	18	M10	35	10.5	10				

R: Sağ / Right / Правый L: Sol / Left / Левый

● Stokta / In Stock / В наличии ○ Stokta Yok / Non Stock Item / Нет в наличии

MTSBH Ucuna Uygunudur. / Compatible with MTSBH Insert. / Под пластину MTSBH.

Sipariş Örneği/Ordering Example/Образец заказа

1 ad./pcs./шт. AHFM-W004T2D-D16-C16-L150-Z02

Kesme Hesabı : S 367 / Cutting Calculation : P 367 / Расчет режимов резания: стр. 367

Sıkma Tork Değeri : S 366 / Tightening Torque : P 366 / Момент затяжки: стр. 366

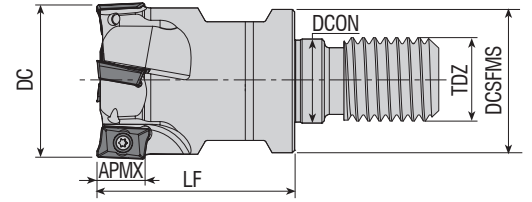

Takım Kodu Ordering Code Код для заказа	Stok Stock Наличие	Takım Ölçüleri (mm) Dimension (mm) Размеры (мм)							Kesici Uç Insert Пластина	Yedek Parçaları / Spare Parts / Запасные части	
		DC	ZEFP	DCSFMS	TDZ	LF	DCON	APMX		Sıkma Vidası Screw Зажимной винт	Tork Anahtar Torx Key Торк Ключ
AEM90-AD1505D-D25-M12-L43-Z02-H	●	25	2	21	M12	43	12.5	14.3	ADKT 150508	4015-M4x9	80-T15
AEM90-AD1505D-D32-M16-L43-Z03-H	●	32	3	29	M16	43	17	14.3		4015-M4x11	

DJT Ucuna Uygundur. / Compatiple with DJT Insert. / Под пластину SMTM-DJT

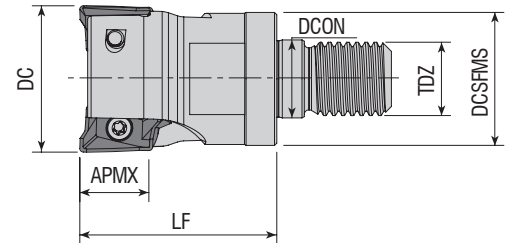

Takım Kodu Ordering Code Код для заказа	Stok Stock Наличие	Takım Ölçüleri (mm) Dimension (mm) Размеры (мм)							Kesici Uç Insert Пластина	Yedek Parçaları / Spare Parts / Запасные части	
		DC	ZEFP	DCSFMS	TDZ	LF	DCON	APMX		Sıkma Vidası Screw Зажимной винт	Tork Anahtar Torx Key Торк Ключ
AEM90-AX1235-D16-M08-L30-Z02-H	●	16	2	14.75	M08	30	8.5	10	AX.T 1235..	3108-M3x6	80-T08
AEM90-AX1235-D20-M10-L30-Z03-H	●	20	3	18	M10	30	10.5	10			
AEM90-AX1235-D25-M12-L35-Z04-H	●	25	4	21	M12	35	12.5	10	AX.T 1705..	4015-M4x9	80-T15
AEM90-AX1705-D25-M12-L43-Z02-H	●	25	2	21	M12	43	12.5	14			
AEM90-AX1705-D32-M16-L43-Z02-H	●	32	2	29	M16	43	17	14			

R: Sağ / Right / Правый L: Sol / Left / Левый

● Stokta / In Stock / В наличии ○ Stokta Yok / Non Stock Item / Нет в наличии
SMTM Ucuna Uygundur. / Compatiple with SMTM Insert. / Под пластину SMTM.

Sipariş Örneği/Ordering Example/Образец заказа

1 ad./pcs./шт. AEM90-AD1505D-D25-M12-L43-Z02-H

Kesme Hesabı : S 367 / Cutting Calculation : P 367 / Расчет режимов резания: стр. 367

Sıkma Tork Değeri : S 367 / Tightening Torque : P 367 / Момент затяжки: стр. 367

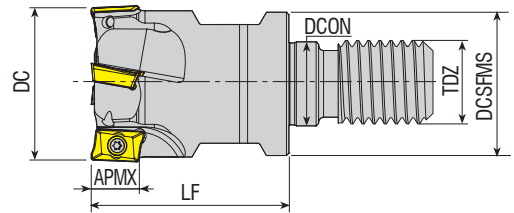

Takım Kodu Ordering Code Код для заказа	Stok Stock Наличие	Takım Ölçüleri (mm) Dimension (mm) Размеры (мм)							Kesici Uç Insert Пластина	Yedek Parçaları / Spare Parts / Запасные части		
		DC	ZEFP	DCSFMS	TDZ	LF	DCON	APMX		Sıkma Vidası Screw Зажимной винт	Tork Anahtar Torx Key Торх Ключ	
AEM90-AP0903-D20-M12-L35-Z03	●	20	3	18	M12	35	12.5	9	APMT 0903.. KRYL UCUNA UYGUNDUR. FOR KRYL INSERT. Под пластину KRYL			
AEM90-AP0903-D25-M12-L35-Z03	●	25	3	21	M12	35	12.5	9				
AEM90-AP10-D16-M08-L30-Z02-H	●	16	2	14.75	M08	30	8.5	10				
AEM90-AP10-D20-M10-L30-Z03-H	●	20	3	18	M10	30	10.5	10	AP. 1003.. ISO UCUNA UYGUNDUR. FOR ISO INSERT. Под пластину ISO	3008-M2.5x6	80-T08	
AEM90-AP10-D25-M12-L35-Z03-H	●	25	3	21	M12	35	12.5	10				
AEM90-AP10-D32-M16-L35-Z04-H	●	32	4	29	M16	35	17	10				
AEM90-AP10-D32-M16-L40-Z04-H	●	32	4	29	M16	40	17	10				
AEM90-AP10-D40-M16-L43-Z05-H	●	40	5	29	M16	43	17	10				
AEM90-AP10-D42-M16-L43-Z05-H	●	42	5	29	M16	43	17	10				
AEM90-AP10D-D16-M08-L30-Z02-H	●	16	2	14.75	M08	30	8.5	10				
AEM90-AP10D-D20-M10-L30-Z03-H	●	20	3	18	M10	30	10.5	10				
AEM90-AP10D-D25-M12-L35-Z03-H	●	25	3	21	M12	35	12.5	10	AP. 1003.. DJT UCUNA UYGUNDUR. FOR DJT INSERT. Под пластину DJT	4015-M4x9	80-T15	
AEM90-AP11-D16-M08-L30-Z02-H	●	16	2	14.75	M08	30	8.5	11				
AEM90-AP11-D20-M10-L30-Z03-H	●	20	3	18	M10	30	10.5	11				
AEM90-AP11-D25-M12-L35-Z03-H	●	25	3	21	M12	35	12.5	11				
AEM90-AP11-D32-M16-L35-Z04-H	●	32	4	29	M16	35	17	11				
AEM90-AP11-D32-M16-L43-Z04-H	●	32	4	29	M16	43	17	11				
AEM90-AP11-D40-M16-L43-Z05-H	●	40	5	29	M16	43	17	11				
AEM90-AP16-D25-M12-L43-Z02-H	●	25	2	21	M12	43	12.5	16				
AEM90-AP16-D32-M16-L43-Z03-H	●	32	3	29	M16	43	17	16	AP. 1604.. ISO UCUNA UYGUNDUR. FOR ISO INSERT. Под пластину ISO	4015-M4x9	80-T15	
AEM90-AP16-D40-M16-L43-Z04-H	●	40	4	29	M16	43	17	16				
AEM90-AP16-D42-M16-L43-Z04-H	●	42	4	29	M16	43	17	16				
AEM90-AP16DJ-D25-M12-L43-Z02-H	●	25	2	21	M12	43	12.5	16				
AEM90-AP16DJ-D32-M16-L43-Z03-H	●	32	3	29	M16	43	17	16				
AEM90-AP16DJ-D40-M16-L43-Z04-H	●	40	4	29	M16	43	17	16				
AEM90-AP16L-D25-M12-L43-Z02-H	●	25	2	21	M12	43	12.5	16				
AEM90-AP16L-D32-M16-L43-Z03-H	●	32	3	29	M16	43	17	16	AP. 1604.. LMN UCUNA UYGUNDUR. FOR LMN INSERT. Под пластину LMN			
AEM90-AP16L-D40-M16-L43-Z04-H	●	40	4	29	M16	43	17	16				

R: Sağ / Right / Правый L: Sol / Left / Левый

● Stokta / In Stock / В наличии ○ Stokta Yok / Non Stock Item / Нет в наличии

Sipariş Örneği/Ordering Example/Образец заказа

1 ad./pcs./шт. AEM90-AP0903-D20-M12-L35-Z03

Kesme Hesabı : S 367 / Cutting Calculation : P 367 / Расчет режимов резания: стр. 367

Sıkma Tork Değeri : S 367 / Tightening Torque : P 367 / Момент затяжки: стр. 367



KAPR=90°

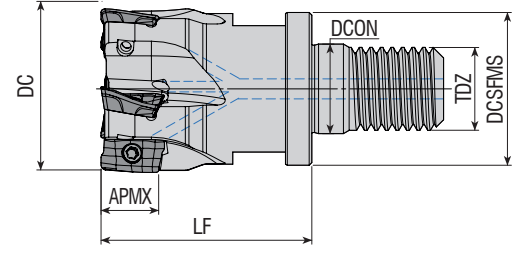

Takım Kodu Ordering Code Код для заказа	Stok Stock Наличие	Takım Ölçüleri (mm) Dimension (mm) Размеры (мм)							Kesici Uç Insert Пластина	Yedek Parçaları / Spare Parts / Запасные части	
		DC	ZEFP	DCSFMS	TDZ	LF	DCON	APMX		Sıkma Vidası Screw Зажимной винт	Tork Anahtar Torx Key Торх Ключ
AEM90-BD11T3-D16-M08-L25-Z02-H	●	16	2	14.75	M08	25	8.5	10	BDMT 11T3..	3008-M2.5x6	80-T08
AEM90-BD11T3-D25-M12-L35-Z04-H	●	25	4	21	M12	35	12.5	10			
AEM90-BD11T3-D32-M16-L40-Z05-H	●	32	5	29	M16	40	17	10			

KYCR Ucuna Uygundur. / Compatible with KYCR Insert. / Под пластину KYCR

KAPR=90°

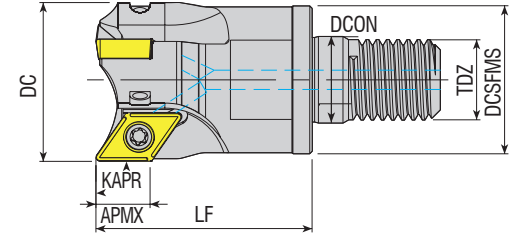

Takım Kodu Ordering Code Код для заказа	Stok Stock Наличие	Takım Ölçüleri (mm) Dimension (mm) Размеры (мм)							Kesici Uç Insert Пластина	Yedek Parçaları / Spare Parts / Запасные части	
		DC	ZEFP	DCSFMS	TDZ	LF	DCON	APMX		Sıkma Vidası Screw Зажимной винт	Tork Anahtar Torx Key Торх Ключ
AEM90-DC07-D20-M10-L30-Z02-H	●	20	2	18	M10	30	10.5	7	DC.T 0702..	3008-M2.5x6	80-T08
AEM90-DC07-D25-M12-L35-Z03-H	●	25	3	21	M12	35	12.5	7			
AEM90-DC07-D32-M16-L43-Z04-H	●	32	4	29	M16	43	17	7			
AEM90-DC07-D40-M16-L43-Z05-H	●	40	5	29	M16	43	17	7			
AEM90-DC11-D32-M16-L43-Z03-H-F	●	32	3	29	M16	43	17	11	DC.T 11T3..	4015-M3.5x9	80-T15
AEM90-DC11-D40-M16-L43-Z03-H-F	●	40	3	29	M16	43	17	11			

R: Sağ / Right / Правый L: Sol / Left / Левый



● Stokta / In Stock / В наличии ○ Stokta Yok / Non Stock Item / Нет в наличии

ISO Ucuna Uygundur. / Compatible with ISO Insert. / Под пластину ISO.

F: Eksenel ve Radyal Salgı Değeri 0,02 mm içindedir. / F: Axial and Radial Runout Value is within 0,02 mm. / F: значение радиального и осевого биения в пределах 0,02 мм.

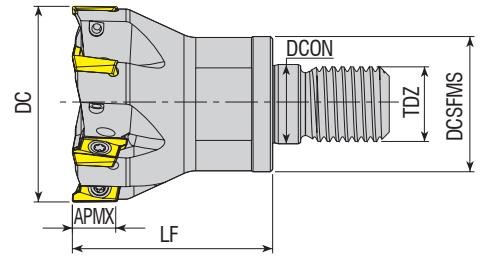

Sipariş Örneği/Ordering Example/Образец заказа
1 ad./pcs./шт. AEM90-BD11T3-D16-M08-L25-Z02-H

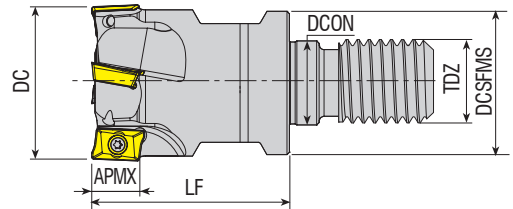

Takım Kodu Ordering Code Код для заказа	Stok Stock Наличие	Takım Ölçüleri (mm) Dimension (mm) Размеры (мм)							Kesici Uç Insert Пластина	Yedek Parçaları / Spare Parts / Запасные части	
		DC	ZEFP	DCSFMS	TDZ	LF	DCON	APMX		Sıkma Vidası Screw Зажимной винт	Tork Anahtar Torx Key Торх Ключ
AEM90-RT10-D16-M08-L20-Z02-H	●	16	2	14.75	M08	20	8.5	10			
AEM90-RT10-D20-M10-L25-Z03-H	●	20	3	18	M10	25	10.5	10			
AEM90-RT10-D25-M12-L30-Z04-H	●	25	4	21	M12	30	12.5	10			
AEM90-RT10-D32-M16-L43-Z05-H	●	32	5	29	M16	43	17	10			
AEM90-RT10-D42-M16-L43-Z06-H	●	42	6	29	M16	43	17	10			

SFTY Ucuna Uygundur. / Compatible with SFTY Insert. / Под пластину SFTY



Takım Kodu Ordering Code Код для заказа	Stok Stock Наличие	Takım Ölçüleri (mm) Dimension (mm) Размеры (мм)							Kesici Uç Insert Пластина	Yedek Parçaları / Spare Parts / Запасные части	
		DC	ZEFP	DCSFMS	TDZ	LF	DCON	APMX		Sıkma Vidası Screw Зажимной винт	Tork Anahtar Torx Key Торх Ключ
AEM90-R390.11-D16-M08-L30-Z02-H	●	16	2	14.75	M08	30	8.5	10		3008-M2.5x5	
AEM90-R390.11-D20-M10-L30-Z03-H	●	20	3	18	M10	30	10.5	10		3008-M2.5x6	
AEM90-R390.11-D25-M12-L35-Z03-H	●	25	3	21	M12	35	12.5	10			
AEM90-R390.11-D32-M16-L43-Z04-H	●	32	4	29	M16	43	17	10			

R: Sağ / Right / Правый L: Sol / Left / Левый

● Stokta / In Stock / В наличии ○ Stokta Yok / Non Stock Item / Нет в наличии

SNDVK Ucuna Uygundur. / Compatible with SNDVK Insert. / Под пластину SNDVK

Sipariş Örneği/Ordering Example/Образец заказа
1 ad./pcs./шт. AEM90-RT10-D16-M08-L20-Z02-H



KAPR=90°

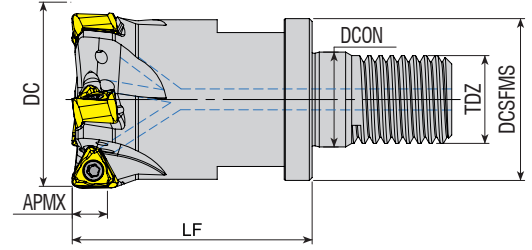

Takım Kodu Ordering Code Код для заказа	Stok Stock Наличие	Takım Ölçüleri (mm) Dimension (mm) Размеры (мм)							Kesici Uç Insert Пластина	Yedek Parçaları / Spare Parts / Запасные части	
		DC	ZEFP	DCSFMS	TDZ	LF	DCON	APMX		Sıkma Vidası Screw Зажимной винт	Tork Anahtar Torx Key Торк Ключ
AEM90-TNG10-D21-M10-L25-Z03-H	●	21	3	18	M10	25	10.5	5	TNGX 1004..	3008-M2.5x6	80-T08
AEM90-TNG10-D26-M12-L30-Z04-H	●	26	4	21	M12	30	12.5	5			
AEM90-TNG10-D33-M16-L43-Z05-H	●	33	5	29	M16	43	17	5			
AEM90-TNG10-D35-M16-L43-Z05-H	●	35	5	29	M16	43	17	5			

PRMT Ucuna Uygundur. / Compatiple with PRMT Insert. / Под пластину PRMT.

KAPR=90°

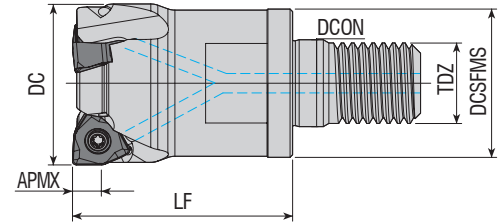

Takım Kodu Ordering Code Код для заказа	Stok Stock Наличие	Takım Ölçüleri (mm) Dimension (mm) Размеры (мм)							Kesici Uç Insert Пластина	Yedek Parçaları / Spare Parts / Запасные части	
		DC	ZEFP	DCSFMS	TDZ	LF	DCON	APMX		Sıkma Vidası Screw Зажимной винт	Tork Anahtar Torx Key Торк Ключ
AEM90-WN0604Z-D25-M12-L35-Z02-H	●	25	2	21	M12	35	12.5	5.7	WNHU 0604..	3008-M3x8	80-T08
AEM90-WN0604Z-D32-M16-L43-Z03-H	●	32	3	29	M16	43	17	5.7			
AEM90-WN0604Z-D40-M16-L43-Z04-H	●	40	4	29	M16	43	17	5.7			

R: Sağ / Right / Правый L: Sol / Left / Левый

● Stokta / In Stock / В наличии ○ Stokta Yok / Non Stock Item / Нет в наличии
ZCC Ucuna Uygundur. / Compatiple with ZCC Insert. / Под пластину ZCC

Sipariş Örneği/Ordering Example/Образец заказа

1 ad./pcs./шт. AEM90-TNG10-D21-M10-L25-Z03-H

Kesme Hesabı : S 367 / Cutting Calculation : P 367 / Расчет режимов резания: стр. 367

Sıkma Tork Değeri : S 367 / Tightening Torque : P 367 / Момент затяжки: стр. 367

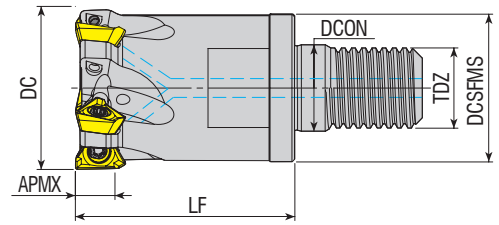

Takım Kodu Ordering Code Код для заказа	Stok Stock Наличие	Takım Ölçüleri (mm) Dimension (mm) Размеры (мм)							Kesici Uç Insert Пластина	Yedek Parçaları / Spare Parts / Запасные части		
		DC	ZEP	DCSFMS	TDZ	LF	DCON	APMX		Sikma Vidası Screw Зажимной винт	Tork Anahtar Torx Key Торх Ключ	
AEM90-3P1004-D20-M10-L35-Z02	●	20	2	18	10	35	10.5	7	3PT 1004	1108-M2.5x6	80-T08	
AEM90-3P1004-D32-M16-L43-Z05-H	●	32	5	29	16	43	17	7				

TGTC Ucuna Uygun. / Compatible with TGTC Insert. / Под пластину TGTC.

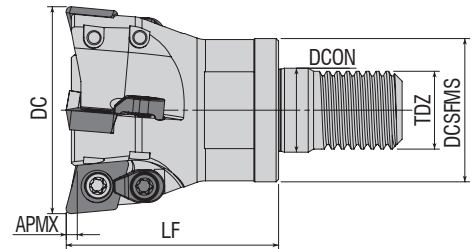

Takım Kodu Ordering Code Код для заказа	Stok Stock Наличие	Takım Ölçüleri (mm) Dimension (mm) Размеры (мм)							Kesici Uç Insert Пластина	Yedek Parçaları / Spare Parts / Запасные части			
		DC	ZEP	DCSFMS	TDZ	LF	DCON	APMX		Sikma Vidası Screw Зажимной винт	Baskı Parçası Wedge Clamp Прижим	Baskı Vidası Clamp Screw Зажимной винт	Tork Anahtar Torx Key Торх Ключ
AEM95-XD0206-D16-M08-L23-Z02-H	●	16	2	14.75	M08	23	8.5	1	XDHW 0206..	3008-M2.5x5	-	-	80-T08
AEM95-XD0206-D16-M08-L23-Z02-H-F	●	16	2	14.75	M08	23	8.5	1					
AEM95-XD0206-D20-M10-L30-Z03-H	●	20	3	18	M10	30	10.5	1		3008-M2.5x6	-	-	80-T08
AEM95-XD0206-D20-M10-L30-Z03-H-F	●	20	3	18	M10	30	10.5	1					
AEM95-XD0206-D25-M12-L35-Z03-H	●	25	3	21	M12	35	12.5	1		3008-M2.5x6	-	-	80-T08
AEM95-XD0206-D25-M12-L35-Z03-H-F	●	25	3	21	M12	35	12.5	1					
AEM95C-XD0310-D35-M16-L43-Z03-H	●	35	3	29	M16	43	17	1.5	XDHW 0310..	3015-M3.5x9	ACK-15	4015-M3.5x11	80-T15
AEM95C-XD0310-D35-M16-L43-Z03-H-F	●	35	3	29	M16	43	17	1.5					
AEM95C-XD0310-D42-M16-L43-Z04-H	●	42	4	29	M16	43	17	1.5					
AEM95C-XD0310-D42-M16-L43-Z04-H-F	●	42	4	29	M16	43	17	1.5					

R: Sağ / Right / Правый L: Sol / Left / Левый

● Stokta / In Stock / В наличии ○ Stokta Yok / Non Stock Item / Нет в наличии

DJT Ucuna Uygun. / Compatible with DJT Insert. / Под пластину SMTM-DJT

Çap Ölçüsü - 0,02 mm Olarak üretiliyor. F: ± 0,02 mm Demektir. Ör: Ø16 Takım 15,98 ± 0,02 mm yani 16,00 mm - 15,96 mm Olmalıdır.

Diameter Size is produced as - 0.02 mm. F: means ± 0.02 mm. For example: Ø16 tool 15.98 ± 0.02 mm, it means that it should be 16.00 mm - 15.96 mm.

Размер диаметра составляет -0,02 мм. F: означает ± 0,02 мм. Например: Ø16 инструмент 15,98 ± 0,02 мм, должно быть 16,00мм -15,96 мм.

Sipariş Örneği/Ordering Example/Образец заказа

1 ad./pcs./шт. AEM90-3P1004-D20-M10-L35-Z02

Kesme Hesabı : S 367 / Cutting Calculation : P 367 / Расчет режимов резания: стр. 367

Sikma Tork Değeri : S 367 / Tightening Torque : P 367 / Момент затяжки: стр. 367

S-SİSTEM MODÜLER PARMAK FREZELER

S-SYSTEM MODULAR END MILLS (SCREW TYPE TOOLS)

S-ТИП СМЕННЫЕ ФРЕЗЕРНЫЕ ГОЛОВКИ (КРЕПЛЕНИЕ ПОД РЕЗЬБУ)

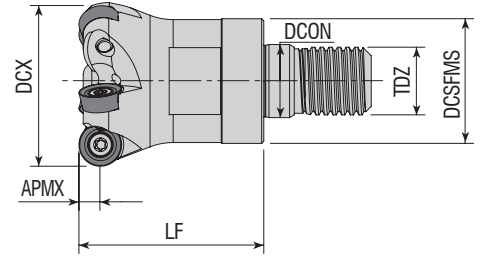

Takım Kodu Ordering Code Код для заказа	Stok Stock Наличие	Takım Ölçüleri (mm) Dimension (mm) Размеры (мм)							Kesici Uç Insert Пластина	Yedek Parçaları / Spare Parts / Запасные части	
		DCX	ZEFP	DCSFMS	TDZ	LF	DCON	APMX		Sıkma Vidası Screw Зажимной винт	Tork Anahtar Torx Key Торх Ключ
AEMR-RC10T3-D25-M12-L35-Z03-H	●	25	3	21	M12	35	12.5	5	RC.. 10T3..	4015-M4x9	80-T15
AEMR-RC10T3-D32-M16-L43-Z04-H	●	32	4	29	M16	43	17	5			
AEMR-RC10T3-D40-M16-L43-Z05-H	●	40	5	29	M16	43	17	5			

ZCC Ucuna Uygundur. / Compatiple with ZCC Insert. / Под пластину ZCC

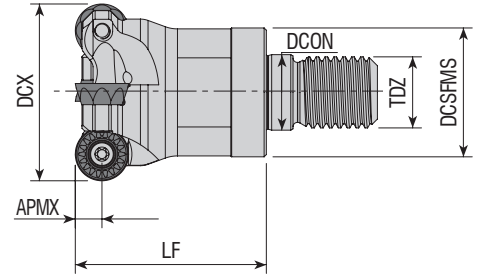

Takım Kodu Ordering Code Код для заказа	Stok Stock Наличие	Takım Ölçüleri (mm) Dimension (mm) Размеры (мм)							Kesici Uç Insert Пластина	Yedek Parçaları / Spare Parts / Запасные части	
		DCX	ZEFP	DCSFMS	TDZ	LF	DCON	APMX		Sıkma Vidası Screw Зажимной винт	Tork Anahtar Torx Key Торх Ключ
AEMR-RP08T2M-D20-M10-L30-Z02-H	●	20	2	18	M10	30	10.5	4	RPMT 08T2..	3008-M2.5x6	80-T08
AEMR-RP10T3M-D25-M12-L35-Z02-H	●	25	2	21	M12	35	12.5	5	RPMT 10T3..	4015-M3.5x9	80-T15
AEMR-RP10T3M-D32-M16-L43-Z03-H	●	32	3	29	M16	43	17	5	RPMT 1204..	4015-M4x9	
AEMR-RP1204M-D32-M16-L43-Z03-H	●	32	3	29	M16	43	17	6			
AEMR-RP1204M-D40-M16-L43-Z04-H	●	40	4	29	M16	43	17	6			

R: Sağ / Right / Правый L: Sol / Left / Левый

● Stokta / In Stock / В наличии ○ Stokta Yok / Non Stock Item / Нет в наличии

MTSBSH Ucuna Uygundur. / Compatiple with MTSBSH Insert. / Под пластину MTSBSH

Sipariş Örneği/Ordering Example/Образец заказа



1 ad./pcs./шт. AEMR-RC10T3-D25-M12-L35-Z03-H

Kesme Hesabı : S 367 / Cutting Calculation : P 367 / Расчет режимов резания: стр. 367

Sıkma Tork Değeri : S 367 / Tightening Torque : P 367 / Момент затяжки: стр. 367

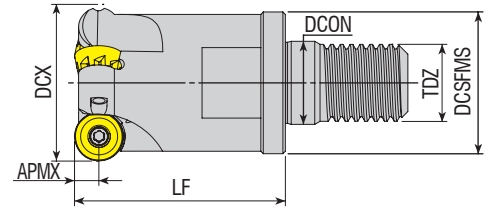



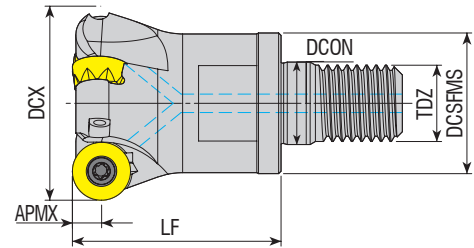

Takım Kodu Ordering Code Код для заказа	Stok Stock Наличие	Takım Ölçüleri (mm) Dimension (mm) Размеры (мм)							Kesici Uç Insert Пластина	Yedek Parçaları / Spare Parts / Запасные части		
		DCX	ZEFP	DCSFMS	TDZ	LF	DCON	APMX		Sıkma Vidası Screw Зажимной винт	Tork Anahtar Torx Key Торх Ключ	
AEMR-RP10T3-D25-M12-L35-Z02-H	●	25	2	21	M12	35	12.5	5				
AEMR-RP10T3-D32-M16-L43-Z03-H	●	32	3	29	M16	43	17	5				
AEMR-RP1204-D32-M16-L43-Z03-H	●	32	3	29	M16	43	17	6				RPNX 1204..

CRTZT Ucuna Uygunur. / Compatible with CRTZT Insert. / Под пластину CRTZT



Takım Kodu Ordering Code Код для заказа	Stok Stock Наличие	Takım Ölçüleri (mm) Dimension (mm) Размеры (мм)							Kesici Uç Insert Пластина	Yedek Parçaları / Spare Parts / Запасные части		
		DCX	ZEFP	DCSFMS	TDZ	LF	DCON	APMX		Sıkma Vidası Screw Зажимной винт	Tork Anahtar Torx Key Торх Ключ	
AEMR-RY10-D32-M16-L43-Z04-H	●	32	4	29	M16	43	17	5				
AEMR-RY10-D40-M16-L43-Z05-H	●	40	5	29	M16	43	17	5				
AEMR-RY12-D32-M16-L43-Z03-H	●	32	3	29	M16	43	17	6				RYMX 1205..
AEMR-RY12-D40-M16-L43-Z03-H	●	40	3	29	M16	43	17	6				

R: Sağ / Right / Правый L: Sol / Left / Левый
● Stokta / In Stock / В наличии ○ Stokta Yok / Non Stock Item / Нет в наличии
TGTC Ucuna Uygunur. / Compatible with TGTC Insert. / Под пластину TGTC.

Sipariş Örneği/Ordering Example/Образец заказа
1 ad./pcs./шт. AEMR-RP10T3-D25-M12-L35-Z02-H
Kesme Hesabı : S 367 / Cutting Calculation : P 367 / Расчет режимов резания: стр. 367
Sıkma Tork Değeri : S 367 / Tightening Torque : P 367 / Момент затяжки: стр. 367

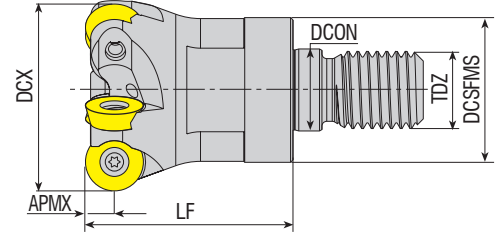

Takım Kodu Ordering Code Код для заказа	Stok Stock Наличие	Takım Ölçüleri (mm) Dimension (mm) Размеры (мм)							Kesici Uç Insert Пластина	Yedek Parçaları / Spare Parts / Залпасные части			
		DCX	ZEPF	DCSFMS	TDZ	LF	DCON	APMX		Sıkma Vidası Screw Зажимной винт	Tork Anahtar Torx Key Торх Ключ		
AEMR-RD0702-D15-M08-L23-Z02-H	●	15	2	13	M08	23	8.5	3.5	RD.. 0702	3008-M2.5x6	80-T08		
AEMR-RD0702-D16-M08-L23-Z02-H	●	16	2	13	M08	23	8.5	3.5					
AEMR-RD0702-D20-M10-L30-Z04-H	●	20	4	18	M10	30	10.5	3.5					
AEMR-RD0702-D25-M12-L35-Z05-H	●	25	5	21	M12	35	12.5	3.5					
AEMR-RD0702-D30-M16-L42-Z05-H	●	30	5	29	M16	42	17	3.5					
AEMR-RD0702-D32-M16-L43-Z05-H	●	32	5	29	M16	43	17	3.5					
AEMR-RD0702-D35-M16-L42-Z06-H	●	35	6	29	M16	42	17	3.5					
AEMR-RD0702-D42-M16-L43-Z05-H	●	42	5	29	M16	43	17	3.5					
AEMR-RD0702-D42-M16-L43-Z07-H	●	42	7	29	M16	43	17	3.5					
AEMR-RD08T2-D16-M08-L23-Z02-H	●	16	2	13	M08	23	8.5	4	RD.. 08T2	3008-M2.5x6	80-T08		
AEMR-RD08T2-D16-M10-L23-Z02-H	●	16	2	13	M10	23	8.5	4					
AEMR-RD08T2-D20-M10-L30-Z03-H	●	20	3	18	M10	30	10.5	4					
AEMR-RD08T2-D25-M12-L35-Z04-H	●	25	4	21	M12	35	12.5	4					
AEMR-RD0802-D16-M08-L23-Z02-H	●	16	2	13	M08	23	8.5	4	RD.. 0802	3008-M3x6	80-T15		
AEMR-RD0803-D16-M08-L23-Z02-H	●	16	2	13	M08	23	8.5	4	RD.. 0803	3008-M3x8			
AEMR-RD0803-D20-M10-L30-Z03-H	●	20	3	18	M10	30	10.5	4					
AEMR-RD0803-D25-M12-L35-Z04-H	●	25	4	21	M12	35	12.5	4					
AEMR-RD1003-D20-M10-L30-Z02-H	●	20	2	18	M10	30	10.5	5	RD.. 1003	4015-M3.5x9	80-T15		
AEMR-RD1003-D25-M12-L35-Z02-H	●	25	2	21	M12	35	12.5	5					
AEMR-RD1003-D25-M12-L35-Z03-H	●	25	3	21	M12	35	12.5	5					
AEMR-RD1003-D30-M16-L43-Z04-H	●	30	4	29	M16	43	17	5					
AEMR-RD1003-D32-M16-L43-Z04-H	●	32	4	29	M16	43	17	5					
AEMR-RD1003-D35-M16-L43-Z04-H	●	35	4	29	M16	43	17	5					
AEMR-RD1003-D40-M16-L43-Z05-H	●	40	5	29	M16	43	17	5					
AEMR-RD1003-D42-M16-L43-Z05-H	●	42	5	29	M16	43	17	5					
AEMR-RD10T3-D25-M12-L35-Z03-H	●	25	3	21	M12	35	12.5	5				RD.. 10T3	4015-M3.5x9
AEMR-RD10T3-D32-M16-L45-Z04-H	●	32	4	29	M16	45	17	5					
AEMR-RD1004-D25-M12-L35-Z03-H	●	25	3	21	M12	35	12.5	5	RD.. 1004	4515-M4x8			
AEMR-RD1004-D32-M16-L43-Z04-H	●	32	4	29	M16	43	17	5					
AEMR-RD12T3-D24-M12-L35-Z02-H	●	24	2	21	M12	35	12.5	6	RD.. 12T3	4015-M3.5x9	80-T15		
AEMR-RD12T3-D25-M12-L35-Z02-H	●	25	2	21	M12	35	12.5	6					
AEMR-RD12T3-D32-M16-L43-Z03-H	●	32	3	29	M16	43	17	6					
AEMR-RD12T3-D35-M16-L43-Z03-H	●	35	3	29	M16	43	17	6					
AEMR-RD12T3-D35-M16-L43-Z04-H	●	35	4	29	M16	43	17	6					
AEMR-RD12T3-D40-M16-L43-Z04-H	●	40	4	29	M16	43	17	6					
AEMR-RD12T3-D42-M16-L43-Z05-H	●	42	5	29	M16	43	17	6					
AEMR-RD1204-D32-M16-L43-Z03-H	●	32	3	29	M16	43	17	6				RD.. 1204	
AEMR-RD1204-D42-M16-L43-Z04-H	●	42	4	29	M16	43	17	6					
AEMR-RD1604-D32-M16-L43-Z02-H	●	32	2	29	M16	43	17	8	RD.. 1604	4015-M4.5x11	80-T15		
AEMR-RD1604-D40-M16-L43-Z02-H	●	40	2	29	M16	43	17	8					
AEMR-RD1604-D42-M16-L43-Z03-H	●	42	3	29	M16	43	17	8					

R: Sağ / Right / Правый L: Sol / Left / Левый

● Stokta / In Stock / В наличии ○ Stokta Yok / Non Stock Item / Нет в наличии
ISO Ucuna Uygundur. / Compatible with ISO Insert. / Под пластину ISO.

Sipariş Örneği/Ordering Example/Образец заказа

1 ad./pcs./шт. AEMR-RD0702-D15-M08-L23-Z02-H

Kesme Hesabı : S 367 / Cutting Calculation : P 367 / Расчет режимов резания: стр. 367

Sıkma Tork Değeri : S 367 / Tightening Torque : P 367 / Момент затяжки: стр. 367

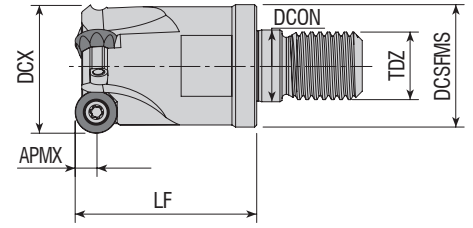

Takım Kodu Ordering Code Код для заказа	Stok Stock Наличие	Takım Ölçüleri (mm) Dimension (mm) Размеры (мм)							Kesici Uç Insert Пластина	Yedek Parçaları / Spare Parts / Запасные части		
		DCX	ZEFP	DCSFMS	TDZ	LF	DCON	APMX		Sikma Vidası Screw Зажимной винт	Tork Anahtar Torx Key Торх Ключ	
AEMR-QP10T3-D25-M12-L35-Z02-H	●	25	2	21	M12	35	12.5	5	QP. 10T3..	4015-M3.5x9	80-T15	
AEMR-QP10T3-D32-M16-L43-Z03-H	●	32	3	29	M16	43	17	5				

SMTM Ucuna Uygun. / Compatiple with SMTM Insert. / Под пластину SMTM.

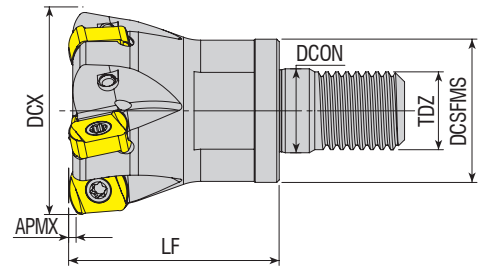

Takım Kodu Ordering Code Код для заказа	Stok Stock Наличие	Takım Ölçüleri (mm) Dimension (mm) Размеры (мм)							Kesici Uç Insert Пластина	Yedek Parçaları / Spare Parts / Запасные части		
		DCX	ZEFP	DCSFMS	TDZ	LF	DCON	APMX		Sikma Vidası Screw Зажимной винт	Tork Anahtar Torx Key Торх Ключ	
AHFM-BL0603-D20-M10-L30-Z03-H	●	20	3	18	M10	30	10.5	1	BLMP 0603..	3008-M2.5x6	80-T08	
AHFM-BL0603-D32-M16-L40-Z05-H	●	32	5	29	M16	40	17	1				
AHFM-BL0904-D32-M16-L40-Z04-H	●	32	4	29	M16	40	17	1.5	BLMP 0904..	3010-M3.5x9	80-T10	
AHFM-BL0904-D32-M16-L43-Z04-H	●	32	4	29	M16	43	17	1.5				
AHFM-BL0904-D42-M16-L43-Z05-H	●	42	5	29	M16	43	17	1.5				

R: Sağ / Right / Правый L: Sol / Left / Левый

● Stokta / In Stock / В наличии ○ Stokta Yok / Non Stock Item / Нет в наличии

TGTC Ucuna Uygun. / Compatiple with TGTC Insert. / Под пластину TGTC.

Sipariş Örneği/Ordering Example/Образец заказа

1 ad./pcs./шт. AEMR-QP10T3-D25-M12-L35-Z02-H

Kesme Hesabı : S 367 / Cutting Calculation : P 367 / Расчет режимов резания: стр. 367

Sikma Tork Değeri : S 367 / Tightening Torque : P 367 / Момент затяжки: стр. 367

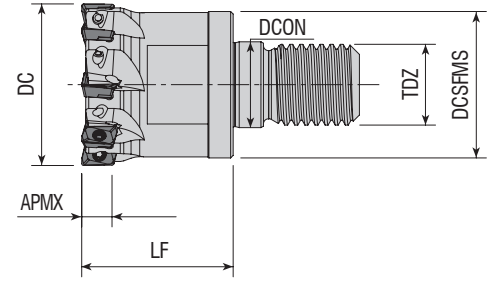

Takım Kodu Ordering Code Код для заказа	Stok Stock Наличие	Takım Ölçüleri (mm) Dimension (mm) Размеры (мм)							Kesici Uç Insert Пластина	Yedek Parçaları / Spare Parts / Запасные части	
		DC	ZEFP	DCSFMS	TDZ	LF	DCON	APMX		Sıkma Vidası Screw Зажимной винт	Tork Anahtar Torx Key Торх Ключ
AHFM-ED0702-D12-M06-L20-Z03	●	12	3	10	M06	20	6.5	6	EDMT 0702 JDMT 070204	3006-M1.8x4	80-T06
AHFM-ED0702-D16-M08-L25-Z04-H	●	16	4	14.75	M08	25	8.5	6			
AHFM-ED0702-D20-M10-L30-Z05-H	●	20	5	18	M10	30	10.5	6			
AHFM-ED0702-D25-M12-L30-Z06-H	●	25	6	21	M12	30	12.5	6			
AHFM-ED0702-D32-M16-L30-Z08-H	●	32	8	29	M16	30	17	6			

HTCH Ucuna Uygunudur. / Compatible with HTCH Insert. / Под пластину HTCH

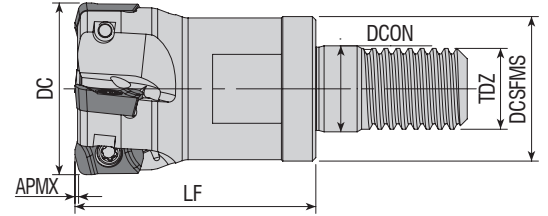

Takım Kodu Ordering Code Код для заказа	Stok Stock Наличие	Takım Ölçüleri (mm) Dimension (mm) Размеры (мм)							Kesici Uç Insert Пластина	Yedek Parçaları / Spare Parts / Запасные части	
		DC	ZEFP	DCSFMS	TDZ	LF	DCON	APMX		Sıkma Vidası Screw Зажимной винт	Tork Anahtar Torx Key Торх Ключ
AHFM-EP1003-D16-M08-L23-Z02-H	●	16	2	14.75	M08	23	8.5	1	EP. 1003.. ZPMT 1003.. YPHW 1003..	3008-M2.5x5	80-T08
AHFM-EP1003-D20-M10-L30-Z04-H	●	20	4	18	M10	30	10.5	1			
AHFM-EP1003-D25-M12-L35-Z04-H	●	25	4	21	M12	35	12.5	1			
AHFM-EP1003-D32-M16-L43-Z05-H	●	32	5	29	M16	43	17	1			
AHFM-EP1003-D35-M16-L43-Z05-H	●	35	5	29	M16	43	17	1			
AHFM-EP1003-D42-M16-L43-Z06-H	●	42	6	29	M16	43	17	1			

R: Sağ / Right / Правый L: Sol / Left / Левый

● Stokta / In Stock / В наличии ○ Stokta Yok / Non Stock Item / Нет в наличии

DJT Ucuna Uygunudur. / Compatible with DJT Insert. / Под пластину SMTM-DJT

Sipariş Örneği/Ordering Example/Образец заказа

1 ad./pcs./шт. AHFM-ED0702-D12-M06-L20-Z03

Kesme Hesabı : S 367 / Cutting Calculation : P 367 / Расчет режимов резания: стр. 367

Sıkma Tork Değeri : S 367 / Tightening Torque : P 367 / Момент затяжки: стр. 367

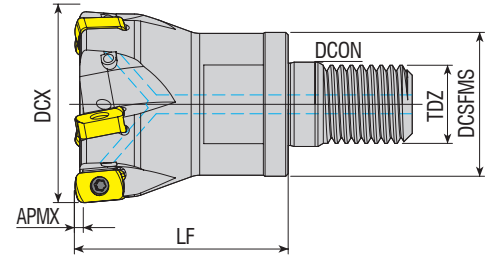

Takım Kodu
Ordering Code
Код для заказа

Stok Stock Наличие	Takım Ölçüleri (mm) Dimension (mm) Размеры (мм)							Kesici Uç Insert Пластина	Yedek Parçaları / Spare Parts / Запасные части			
	DCX	ZEP	DCSFMS	TDZ	LF	DCON	APMX		Sikma Vidası Screw Зажимной винт	Baskı Parçası Wedge Clamp Прижим	Baskı Vidası Clamp Screw Зажимной винт	Tork Anahtar Torx Key Торх Ключ
●	16	2	14.75	M08	23	8.5	1	ENMU 1004..	3008-M2.5x5			80-T08
●	20	3	18	M10	30	10.5	1					
●	25	3	21	M12	35	12.5	1					
●	25	4	21	M12	35	12.5	1					
●	32	5	29	M16	43	17	1					
●	35	5	29	M16	43	17	1					
●	40	5	29	M16	43	17	1					
●	42	5	29	M16	43	17	1					

R: Sağ / Right / Правый L: Sol / Left / Левый
● Stokta / In Stock / В наличии ○ Stokta Yok / Non Stock Item / Нет в наличии
DJT Ucuna Uygunudur. / Compatiple with DJT Insert. / Под пластину SMTM-DJT

Sipariş Örneği/Ordering Example/Образец заказа
1 ad./pcs./шт. AHFM-EN1004-D16-M08-L23-Z02-H
Kesme Hesabı : S 367 / Cutting Calculation : P 367 / Расчет режимов резания: стр. 367
Sıkma Tork Değeri : S 367 / Tightening Torque : P 367 / Момент затяжки: стр. 367



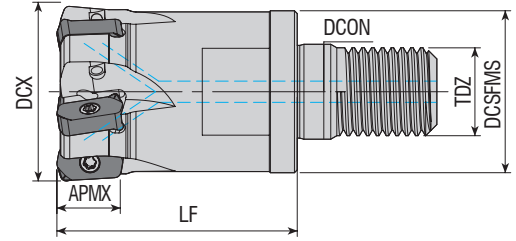

Takım Kodu Ordering Code Код для заказа	Stok Stock Наличие	Takım Ölçüleri (mm) Dimension (mm) Размеры (мм)						Kesici Uç Insert Пластина	Yedek Parçaları / Spare Parts / Запасные части				
		DCX	ZEPF	DCSFMS	TDZ	LF	DCON		APMX	Sıkma Vidası Screw Зажимной винт	Baskı Parçası Wedge Clamp Прижим	Baskı Vidası Clamp Screw Зажимной винт	Tork Anahtar Torx Key Торх Ключ
AHFM-LN0303-D25-M12-L35-Z04-H	●	25	4	21	M12	35	12.5	12	LNMU 0303..	3008-M2.5x6	-	-	80-T08
AHFM-LN0303-D32-M16-L43-Z05-H	●	32	5	29	M16	43	17	12					
AHFM-LN0303-D42-M16-L43-Z06-H	●	42	6	29	M16	43	17	12					

TNGLY Ucuna Uygun. / Compatiple with TNGLY Insert. / Под пластину TNGLY

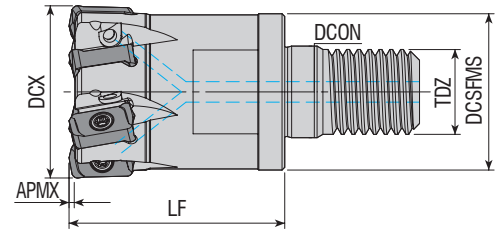

Takım Kodu Ordering Code Код для заказа	Stok Stock Наличие	Takım Ölçüleri (mm) Dimension (mm) Размеры (мм)						Kesici Uç Insert Пластина	Yedek Parçaları / Spare Parts / Запасные части				
		DCX	ZEPF	DCSFMS	TDZ	LF	DCON		APMX	Sıkma Vidası Screw Зажимной винт	Baskı Parçası Wedge Clamp Прижим	Baskı Vidası Clamp Screw Зажимной винт	Tork Anahtar Torx Key Торх Ключ
AHFM-L003-D20-M10-L30-Z04-H-F	●	20	4	18	M10	30	10.5	1	LOGU 0303..	1108-M3x6.8	-	-	80-T08
AHFM-L003-D25-M12-L35-Z04-H-F	●	25	4	21	M12	35	12.5	1					
AHFM-L003-D25-M12-L35-Z04-H	●	25	4	21	M12	35	12.5	1					
AHFM-L003-D32-M16-L40-Z05-H-F	●	32	5	29	M16	40	17	1					
AHFM-L003-D32-M16-L40-Z05-H	●	32	5	29	M16	40	17	1					
AHFM-L003-D32-M16-L40-Z06-H-F	●	32	6	29	M16	40	17	1					
AHFM-L003-D32-M16-L40-Z06-H	●	32	6	29	M16	40	17	1					
AHFM-L003-D35-M16-L40-Z05-H	●	35	5	29	M16	40	17	1					
AHFM-L003-D35-M16-L40-Z06-H	●	35	6	29	M16	40	17	1					
AHFM-L003-D42-M16-L40-Z05-H	●	42	5	29	M16	40	17	1					
AHFM-L003-D42-M16-L40-Z06-H	●	42	6	29	M16	40	17	1					

R: Sağ / Right / Правый L: Sol / Left / Левый

● Stokta / In Stock / В наличии ○ Stokta Yok / Non Stock Item / Нет в наличии

KYCR Ucuna Uygun. / Compatiple with KYCR Insert. / Под пластину KYCR

F: Eksenel ve Radyal Salgı Değeri 0,02 mm İçindedir. / F: Axial and Radial Runout Value is within 0,02 mm.

F: значение радиального и осевого биения в пределах 0,02 мм.

Sipariş Örneği/Ordering Example/Образец заказа

1 ad./pcs./шт. AHFM-LN0303-D25-M12-L35-Z04-H

Kesme Hesabı : S 367 / Cutting Calculation : P 367 / Расчет режимов резания: стр. 367

Sıkma Tork Değeri : S 367 / Tightening Torque : P 367 / Момент затяжки: стр. 367

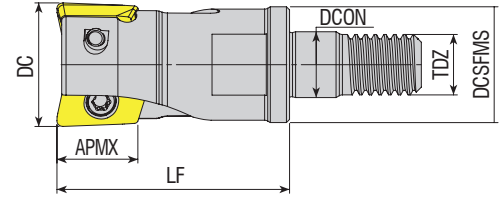
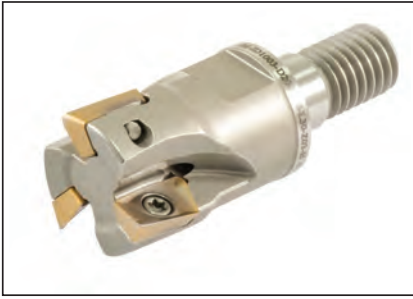

Takım Kodu Ordering Code Код для заказа	Stok Stock Наличие	Takım Ölçüleri (mm) Dimension (mm) Размеры (мм)							Kesici Uç Insert Пластина	Yedek Parçaları / Spare Parts / Запасные части		
		DC	ZEFP	DCSFMS	TDZ	LF	DCON	APMX		Sıkma Vidası Screw Зажимной винт	Tork Anahtar Torx Key Торх Ключ	
AHFM-JD1003-D16-M08-L30-Z02-H	●	16	2	14.75	M08	30	8.5	9				
AHFM-JD1003-D20-M10-L30-Z03-H	●	20	3	18	M10	30	10.5	9	JDMT 1003..	3008-M2.5x6	80-T08	

HTCH Ucuna Uygundur. / Compatible with HTCH Insert. / Под пластину HTCH

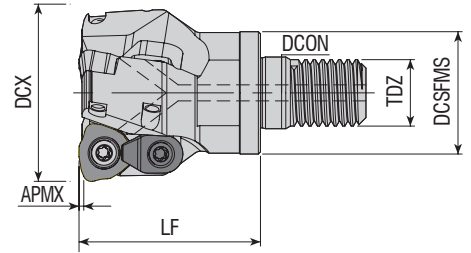

Takım Kodu Ordering Code Код для заказа	Stok Stock Наличие	Takım Ölçüleri (mm) Dimension (mm) Размеры (мм)							Kesici Uç Insert Пластина	Yedek Parçaları / Spare Parts / Запасные части				
		DCX	ZEFP	DCSFMS	TDZ	LF	DCON	APMX		Sıkma Vidası Screw Зажимной винт	Baskı Parçası Wedge Clamp Прижим	Baskı Vidası Clamp Screw Зажимной винт	Tork Anahtar Torx Key Торх Ключ	
AHFMC-JD1204-D32-M16-L43-Z02-H	●	32	2	29	M16	43	17	1.5						
AHFMC-JD1204-D42-M16-L43-Z03-H	●	42	3	29	M16	43	17	1.5	JDMW 1204..	4615-M4x11	ACK-05	4015-M4x11	80-T15	

R: Sağ / Right / Правый L: Sol / Left / Левый

● Stokta / In Stock / В наличии ○ Stokta Yok / Non Stock Item / Нет в наличии

MTSBSH Ucuna Uygundur. / Compatible with MTSBSH Insert. / Под пластину MTSBSH

Sipariş Örneği/Ordering Example/Образец заказа
1 ad./pcs./шт. AHFM-JD1003-D16-M08-L30-Z02-H

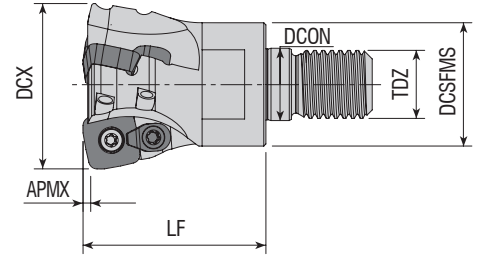

Takım Kodu Ordering Code Код для заказа	Stok Stock Наличие	Takım Ölçüleri (mm) Dimension (mm) Размеры (мм)							Kesici Uç Insert Пластина	Yedek Parçaları / Spare Parts / Запасные части			
		DCX	ZEPF	DCSFMS	TDZ	LF	DCON	APMX		Sıkma Vidası Screw Зажимной винт	Baskı Parçası Wedge Clamp Прижим	Baskı Vidası Clamp Screw Зажимной винт	Tork Anahtar Torx Key Торх Ключ
AHFM-SD06T2-D16-M08-L23-Z02-H	●	16	2	14.75	M08	23	8.5	0.8	SD.. 06T2..	3007-M2.2x5	-	-	80-T07
AHFM-SD06T2-D20-M10-L30-Z03-H	●	20	3	18	M10	30	10.5	0.8					
AHFM-SD06T2-D25-M12-L35-Z04-H	●	25	4	21	M12	35	12.5	0.8					
AHFMC-SD09T3-D25-M12-L30-Z02-H	●	25	2	22	M12	30	12.5	1.4	SD.. 09T3..	3010-M3.5x9	ACK-15	1510-M3.5x9	80-T10
AHFMC-SD09T3-D32-M16-L43-Z03-H	●	32	3	29	M16	43	17	1.4					
AHFMC-SD09T3-D35-M16-L43-Z03-H	●	35	3	29	M16	43	17	1.4					
AHFMC-SD09T3-D40-M16-L43-Z04-H	●	40	4	29	M16	43	17	1.4	SD.. 1204..	4015-M4x9	-	4015-M3.5X11	80-T15
AHFMC-SD1204-D32-M16-L43-Z02-H	●	32	2	29	M16	43	17	1.8					
AHFMC-SD1204-D40-M16-L43-Z03-H	●	40	3	29	M16	43	17	1.8					

ZCC Ucuna Uygundur. / Compatible with ZCC Insert. / Под пластину ZCC

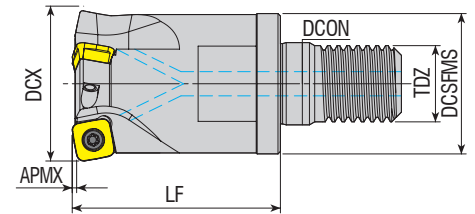

Takım Kodu Ordering Code Код для заказа	Stok Stock Наличие	Takım Ölçüleri (mm) Dimension (mm) Размеры (мм)							Kesici Uç Insert Пластина	Yedek Parçaları / Spare Parts / Запасные части			
		DCX	ZEPF	DCSFMS	TDZ	LF	DCON	APMX		Sıkma Vidası Screw Зажимной винт	Baskı Parçası Wedge Clamp Прижим	Baskı Vidası Clamp Screw Зажимной винт	Tork Anahtar Torx Key Торх Ключ
AHFM-S00803-D20-M10-L30-Z02-H	●	20	2	18	M10	30	10.5	1	SOMW 0803..	4010-M3X8	-	-	80-T10
AHFM-S00803-D25-M12-L35-Z03-H	●	25	3	22	M12	35	12.5	1					
AHFM-S00803-D32-M16-L43-Z03-H	●	32	3	29	M16	43	17	1					
AHFM-S00803-D32-M16-L43-Z04-H	●	32	4	29	M16	43	17	1					
AHFM-S00803-D40-M16-L43-Z04-H	●	40	4	29	M16	43	17	1					

R: Sağ / Right / Правый L: Sol / Left / Левый

● Stokta / In Stock / В наличии ○ Stokta Yok / Non Stock Item / Нет в наличии

KPTK Ucuna Uygundur. / Compatible with KPTK Insert. / Под пластину KPTK

Sipariş Örneği/Ordering Example/Образец заказа
 1 ad./pcs./шт. AHFM-SD06T2-D16-M08-L23-Z02-H

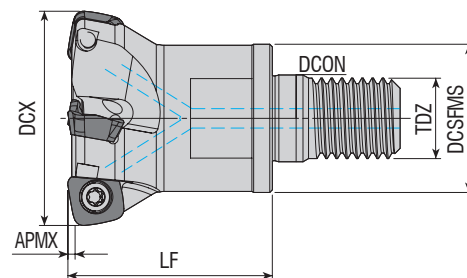

Takım Kodu Ordering Code Код для заказа	Stok Stock Наличие	Takım Ölçüleri (mm) Dimension (mm) Размеры (мм)							Kesici Uç Insert Пластина	Yedek Parçaları / Spare Parts / Запасные части				
		DCX	ZEFP	DCSFMS	TDZ	LF	DCON	APMX		Sıkma Vidası Screw Зажимной винт	Baskı Parçası Wedge Clamp Прижим	Baskı Vidası Clamp Screw Зажимной винт	Tork Anahtar Torx Key Торх Ключ	
AHFM-SO1004-D32-M16-L40-Z03-H	●	32	3	29	M16	40	17	1.5	SOMT 1004..	4015-M4x9	-	-	80-T15	
AHFM-SO1004-D40-M16-L40-Z04-H	●	40	4	29	M16	40	17	1.5						
AHFM-SO1004-D42-M16-L40-Z04-H	●	42	4	29	M16	40	17	1.5						

KYCR Ucuna Uygundur. / Compatible with KYCR Insert. / Под пластину KYCR

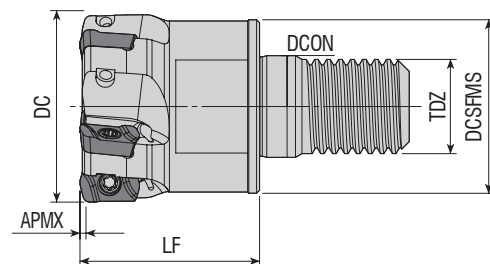

Takım Kodu Ordering Code Код для заказа	Stok Stock Наличие	Takım Ölçüleri (mm) Dimension (mm) Размеры (мм)							Kesici Uç Insert Пластина	Yedek Parçaları / Spare Parts / Запасные части				
		DC	ZEFP	DCSFMS	TDZ	LF	DCON	APMX		Sıkma Vidası Screw Зажимной винт	Baskı Parçası Wedge Clamp Прижим	Baskı Vidası Clamp Screw Зажимной винт	Tork Anahtar Torx Key Торх Ключ	
AHFM-YP1003-D16-M08-L23-Z02-F	●	16	2	14.75	M08	23	8.5	1	EP. 1003.. ZPMT 1003.. YPHW 1003..	3008-M2.5x5	-	-	80-T08	
AHFM-YP1003-D16-M08-L23-Z02-H-F	●	16	2	14.75	M08	23	8.5	1						
AHFM-YP1003-D17-M08-L23-Z02-H	●	17	2	14.75	M08	23	8.5	1						
AHFM-YP1003-D17-M08-L23-Z02-H-F	●	17	2	14.75	M08	23	8.5	1						
AHFM-YP1003-D20-M10-L30-Z03-H	●	20	3	18	M10	30	10.5	1						
AHFM-YP1003-D20-M10-L30-Z03-H-F	●	20	3	18	M10	30	10.5	1						
AHFM-YP1003-D20-M10-L30-Z04-H	●	20	4	18	M10	30	10.5	1						
AHFM-YP1003-D20-M10-L30-Z04-F	●	20	4	18	M10	30	10.5	1						
AHFM-YP1003-D21-M10-L30-Z03-H	●	21	3	18	M10	30	10.5	1						
AHFM-YP1003-D21-M10-L30-Z03-H-F	●	21	3	18	M10	30	10.5	1						
AHFM-YP1003-D25-M12-L35-Z04-H	●	25	4	21	M12	35	12.5	1						
AHFM-YP1003-D25-M12-L35-Z04-F	●	25	4	21	M12	35	12.5	1						
AHFM-YP1003-D25-M12-L35-Z04-H-F	●	25	4	21	M12	35	12.5	1						
AHFM-YP1003-D26-M12-L35-Z04-H-F	●	26	4	21	M12	35	12.5	1						
AHFM-YP1003-D32-M16-L30-Z05-F	●	32	5	29	M16	30	17	1						
AHFM-YP1003-D32-M16-L43-Z05-H-F	●	32	5	29	M16	43	17	1						
AHFM-YP1003-D40-M16-L43-Z06-H-F	●	40	6	29	M16	43	17	1						
AHFM-YP1003-D42-M16-L43-Z06-H-F	●	42	6	29	M16	43	17	1						

R: Sağ / Right / Правый L: Sol / Left / Левый

● Stokta / In Stock / В наличии ○ Stokta Yok / Non Stock Item / Нет в наличии

DJT Ucuna Uygundur. / Compatible with DJT Insert. / Под пластину SMTM-DJT

Çap Ölçüsü - 0,02 mm Olarak Üretiliyor. F: ± 0,02 mm Demektir. Ör: Ø16 Takım 15,98 ± 0,02 mm yani 16,00 mm - 15,96 mm Olmalıdır.

Diameter Size is produced as - 0.02 mm. F: means ± 0,02 mm. For example: Ø16 tool 15,98 ± 0,02 mm, it means that it should be 16,00 mm - 15,96 mm.

Размер диаметра составляет -0,02 мм. F: означает ± 0,02 мм. Например: Ø16 инструмент 15,98 ± 0,02 мм, должно быть 16,00мм -15,96 мм.

Sipariş Örneği/Ordering Example/Образец заказа

1 ad./pcs./шт. AHFM-SO1004-D32-M16-L40-Z03-H

Kesme Hesabı : S 367 / Cutting Calculation : P 367 / Расчет режимов резания: стр. 367

Sıkma Tork Değeri : S 367 / Tightening Torque : P 367 / Момент затяжки: стр. 367

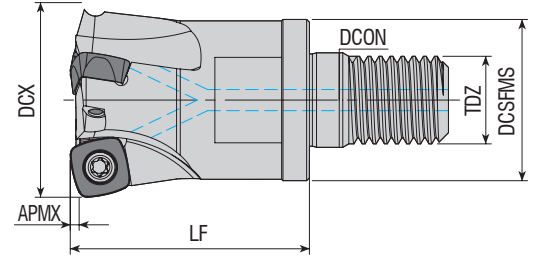

Takım Kodu Ordering Code Код для заказа	Stok Stock Наличие	Takım Ölçüleri (mm) Dimension (mm) Размеры (мм)							Kesici Uç Insert Пластина	Yedek Parçaları / Spare Parts / Запасные части			
		DCX	ZEPF	DCSFMS	TDZ	LF	DCON	APMX		Sıkma Vidası Screw Зажимной винт	Baskı Parçası Wedge Clamp Прижим	Baskı Vidası Clamp Screw Зажимной винт	Tork Anahtar Torx Key Торх Ключ
AHFM-SP1004-D25-M12-L35-Z02-H	●	25	2	21	M12	35	12.5	1	SPNW 1004..		-	-	80-T15
AHFM-SP1004-D32-M16-L43-Z03-H	●	32	3	29	M16	43	17	1.5					
AHFM-SP1004-D35-M16-L43-Z03-H	●	35	3	29	M16	43	17	1.5					
AHFM-SP1004-D42-M16-L43-Z04-H	●	42	4	29	M16	43	17	1.5					

DJT Ucuna Uygunudur. / Compatible with DJT Insert. / Под пластину SMTM-DJT

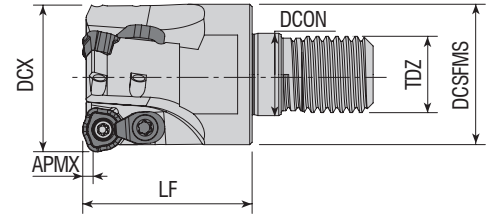

Takım Kodu Ordering Code Код для заказа	Stok Stock Наличие	Takım Ölçüleri (mm) Dimension (mm) Размеры (мм)							Kesici Uç Insert Пластина	Yedek Parçaları / Spare Parts / Запасные части			
		DCX	ZEPF	DCSFMS	TDZ	LF	DCON	APMX		Sıkma Vidası Screw Зажимной винт	Baskı Parçası Wedge Clamp Прижим	Baskı Vidası Clamp Screw Зажимной винт	Tork Anahtar Torx Key Торх Ключ
AHFMC-WD0804-D25-M12-L35-Z02-H	●	25	2	21	M12	35	12.5	1.5	WDMT 0804..		ACK-15	4010-M3x8	80-T10
AHFMC-WD0804-D32-M16-L35-Z03-H	●	32	3	29	M16	35	17	1.5					

R: Sağ / Right / Правый L: Sol / Left / Левый
● Stokta / In Stock / В наличии ○ Stokta Yok / Non Stock Item / Нет в наличии
SMTM Ucuna Uygunudur. / Compatible with SMTM Insert. / Под пластину SMTM.

Sipariş Örneği/Ordering Example/Образец заказа
1 ad./pcs./шт. AHFM-SP1004-D25-M12-L35-Z02-H
Kesme Hesabı : S 367 / Cutting Calculation : P 367 / Расчет режимов резания: стр. 367
Sıkma Tork Değeri : S 367 / Tightening Torque : P 367 / Момент затяжки: стр. 367

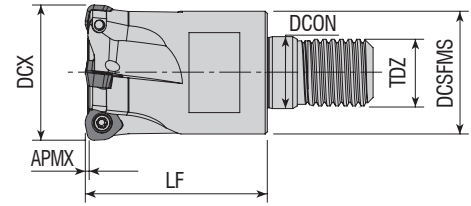

Takım Kodu Ordering Code Код для заказа	Stok Stock Наличие	Takım Ölçüleri (mm) Dimension (mm) Размеры (мм)							Kesici Uç Insert Пластина	Yedek Parçaları / Spare Parts / Запасные части			
		DCX	ZEFP	DCSFMS	TDZ	LF	DCON	APMX		Sıkma Vidası Screw Зажимной винт	Baskı Parçası Wedge Clamp Прижим	Baskı Vidası Clamp Screw Зажимной винт	Tork Anahtar Torx Key Торх Ключ
AHFM-WD0503D-D20-M10-L30-Z02-H	●	20	2	18	M10	30	10.5	1.25	WDMT 0503..	4010-M3x6	-	-	80-T10
AHFM-WD0503D-D25-M12-L35-Z03-H	●	25	3	21	M12	35	12.5	1.25		4010-M3x8	-	-	
AHFM-WD0503D-D32-M16-L43-Z04-H	●	32	4	29	M16	43	17	1.25		-	-	-	
AHFM-WD0503D-D40-M16-L43-Z05-H	●	40	5	29	M16	43	17	1.25		-	-	-	
AHFMC-WD06T3D-D35-M16-L43-Z03-H	●	35	3	29	M16	43	17	1.5	WDHW 06T3..	3015-M3.5x9	ACK-15	4015-M3.5x11	80-T15
AHFMC-WD0805D-D32-M16-L43-Z02-H	●	32	2	29	M16	43	17	2	WDHW 0805..	4020-M4.5x10	ACK-19	4020-M4.5x12	

DJT Ucuna Uygunudur. / Compatiple with DJT Insert. / Под пластину SMTM-DJT

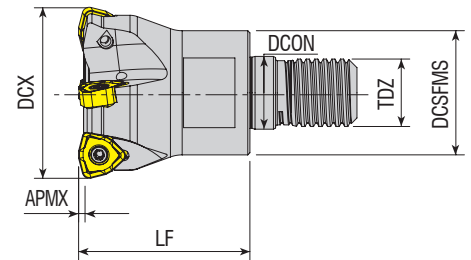

Takım Kodu Ordering Code Код для заказа	Stok Stock Наличие	Takım Ölçüleri (mm) Dimension (mm) Размеры (мм)							Kesici Uç Insert Пластина	Yedek Parçaları / Spare Parts / Запасные части	
		DCX	ZEFP	DCSFMS	TDZ	LF	DCON	APMX		Sıkma Vidası Screw Зажимной винт	Tork Anahtar Torx Key Торх Ключ
AHFM-WN09T3-D32-M16-L40-Z03-H	●	32	3	29	M16	40	17	1.5	WMMX 09T3..	4010-M3x8	80-T10
AHFM-WN09T3-D40-M16-L40-Z04-H	●	40	4	29	M16	40	17	1.5			

R: Sağ / Right / Правый L: Sol / Left / Левый

● Stokta / In Stock / В наличии ○ Stokta Yok / Non Stock Item / Нет в наличии

KRLY Ucuna Uygunudur. / Compatiple with KRLY Insert. / Под пластину KRLY

Sipariş Örneği/Ordering Example/Образец заказа

1 ad./pcs./шт. AHFM-WD0503D-D20-M10-L30-Z02-H

Kesme Hesabı : S 367 / Cutting Calculation : P 367 / Расчет режимов резания: стр. 367

Sıkma Tork Değeri : S 367 / Tightening Torque : P 367 / Момент затяжки: стр. 367

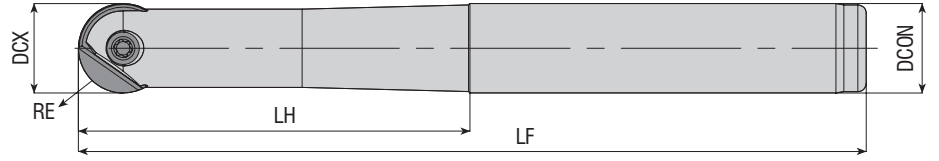

Takım Kodu Ordering Code Код для заказа	Stok Stock Наличие	Takım Ölçüleri (mm) Dimension (mm) Размеры (мм)					Kesici Uç Insert Пластина	Yedek Parçaları / Spare Parts / Запасные части	
		DCX	RE	DCON	LF	LH		Sıkma Vidası Screw Зажимной винт	Tork Anahtar Torx Key Торх Ключ
APMR-BNM12-D12-C12-L130	●	12	6	12	130	32			
APMR-BNM16-D16-C16-L175	●	16	8	16	175	70			
APMR-BNM16-D16-C16-L200	●	16	8	16	200	100			
APMR-BNM20-D20-C20-L160	●	20	10	20	160	70			
APMR-BNM20-D20-C20-L200	●	20	10	20	200	100			
APMR-BNM20-D20-C20-L250	●	20	10	20	250	150			
APMR-BNM25-D25-C25-L160	●	25	12.5	25	160	70			
APMR-BNM25-D25-C25-L200	●	25	12.5	25	200	100			
APMR-BNM25-D25-C25-L250	●	25	12.5	25	250	150			

DJT Ucuna Uygunudur. / Compatiple with DJT Insert. / Под пластину SMTM-DJT

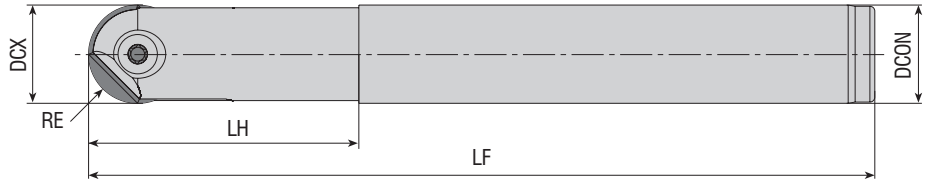

Takım Kodu Ordering Code Код для заказа	Stok Stock Наличие	Takım Ölçüleri (mm) Dimension (mm) Размеры (мм)					Kesici Uç Insert Пластина	Yedek Parçaları / Spare Parts / Запасные части	
		DCX	RE	DCON	LF	LH		Sıkma Vidası Screw Зажимной винт	Tork Anahtar Torx Key Торх Ключ
APMR-RO12-D12-C12-L120	●	12	6	12	120	35			
APMR-RO12-D12-C16-L160	●	12	6	16	160	50			
APMR-RO16-D16-C16-L160	●	16	8	16	160	45			
APMR-RO16-D16-C16-L200	●	16	8	16	200	45			
APMR-RO16-D16-C20-L200	●	16	8	20	200	65			
APMR-RO20-D20-C20-L160	●	20	10	20	160	55			
APMR-RO20-D20-C20-L200	●	20	10	20	200	55			
APMR-RO20-D20-C25-L220	●	20	10	25	220	80			

R: Sağ / Right / Правый L: Sol / Left / Левый

● Stokta / In Stock / В наличии ○ Stokta Yok / Non Stock Item / Нет в наличии

ZCC Ucuna Uygunudur. / Compatiple with ZCC Insert. / Под пластину ZCC

Sipariş Örneği/Ordering Example/Образец заказа

1 ad./pcs./шт. APMR-BNM12-D12-C12-L130

Kesme Hesabı : S 367 / Cutting Calculation : P 367 / Расчет режимов резания: стр. 367

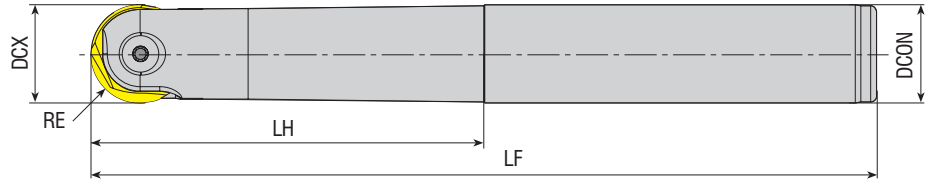

Takım Kodu Ordering Code Код для заказа	Stok Stock Наличие	Takım Ölçüleri (mm) Dimension (mm) Размеры (мм)					Kesici Uç Insert Пластина	Yedek Parçaları / Spare Parts / Запасные части	
		DCX	RE	DCON	LF	LH		Sıkma Vidası Screw Зажимной винт	Tork Anahtar Torx Key Торх Ключ
APMR-P3208-D08-C10-L110	●	8	4	10	110	25		1208-M3x7	80-T08
APMR-P3210-D10-C10-L130	●	10	5	10	130	30		1215-M4x0.5x9	80-T15
APMR-P3210-D10-C12-L130	●	10	5	12	130	30		1220-M5x0.5x9	80-T20
APMR-P3212-D12-C12-L130	●	12	6	12	130	32		1220-M5x0.5x12	
APMR-P3216-D16-C16-L175	●	16	8	16	175	75		1220-M5x0.5x15	
APMR-P3220-D20-C20-L200	●	20	10	20	200	100		1220-M6x0.75x20	AAL-05-4
APMR-P3225-D25-C25-L200	●	25	12.5	25	200	100		1204-M8x0.75x26	
APMR-P3232-D32-C32-L200	●	32	16	32	200	100			

WLTR Ucuna Uygunur. / Compatiple with WLTR Insert. / Под пластину WLTR

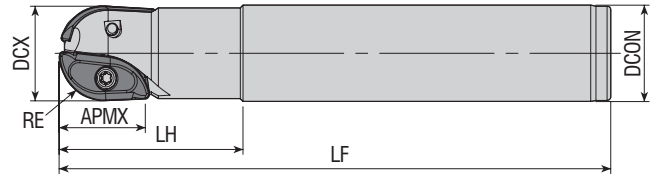

Takım Kodu Ordering Code Код для заказа	Stok Stock Наличие	Takım Ölçüleri (mm) Dimension (mm) Размеры (мм)						Kesici Uç Insert Пластина	Yedek Parçaları / Spare Parts / Запасные части	
		DCX	RE	DCON	LF	LH	APMX		Sıkma Vidası Screw Зажимной винт	Tork Anahtar Torx Key Торх Ключ
APMR-XP16-D16-C16-L150	●	16	8	16	150	40	16		3008-M2.5x6	80-T08
APMR-XP20-D20-C20-L150	●	20	10	20	150	50	20		3010-M3.5x7	80-T10
APMR-XP25-D25-C25-L150	●	25	12.5	25	150	50	25		4015-M4x9	80-T15

R: Sağ / Right / Правый L: Sol / Left / Левый

● Stokta / In Stock / В наличии ○ Stokta Yok / Non Stock Item / Нет в наличии

ZCC Ucuna Uygunur. / Compatiple with ZCC Insert. / Под пластину ZCC

Sipariş Örneği/Ordering Example/Образец заказа

1 ad./pcs./шт. APMR-P3208-D08-C10-L110

Kesme Hesabı : S 367 / Cutting Calculation : P 367 / Расчет режимов резания: стр. 367

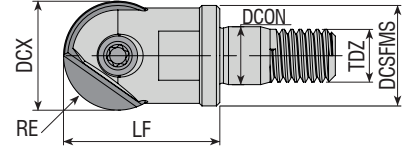

Takım Kodu Ordering Code Код для заказа	Stok Stock Наличие	Takım Ölçüleri (mm) Dimension (mm) Размеры (мм)						Kesici Uç Insert Пластина	Yedek Parçaları / Spare Parts / Запасные части		
		DCX	RE	DCSFMS	TDZ	LF	DCON		Sıkma Vidası Screw Зажимной винт	Tork Anahtar Torx Key Торх Ключ	
APMR-BNM12-D12-M06-L20	●	12	6	11	M06	20	6.5				
APMR-BNM16-D16-M08-L23	●	16	8	14.75	M08	23	8.5				
APMR-BNM20-D20-M10-L30	●	20	10	18	M10	30	10.5				

DJT Ucuna Uygunudur. / Compatible with DJT Insert. / Под пластину SMTM-DJT

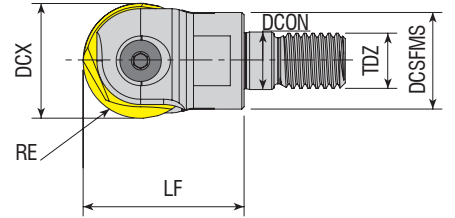

Takım Kodu Ordering Code Код для заказа	Stok Stock Наличие	Takım Ölçüleri (mm) Dimension (mm) Размеры (мм)						Kesici Uç Insert Пластина	Yedek Parçaları / Spare Parts / Запасные части		
		DCX	RE	DCSFMS	TDZ	LF	DCON		Sıkma Vidası Screw Зажимной винт	Tork Anahtar Torx Key Торх Ключ	
APMR-P3216-D16-M08-L25	●	16	8	14	M08	25	8.5				
APMR-P3220-D20-M10-L30	●	20	10	18	M10	30	10.5				
APMR-P3225-D25-M12-L35	●	25	12.5	21	M12	35	12.5				
APMR-P3232-D32-M16-L43	●	32	16	30	M16	43	17				

R: Sağ / Right / Правый L: Sol / Left / Левый

● Stokta / In Stock / В наличии ○ Stokta Yok / Non Stock Item / Нет в наличии

WLTR Ucuna Uygunudur. / Compatible with WLTR Insert. / Под пластину WLTR

Sipariş Örneği/Ordering Example/Образец заказа

1 ad./pcs./шт. APMR-BNM12-D12-M06-L20

Kesme Hesabı : S 367 / Cutting Calculation : P 367 / Расчет режимов резания: стр. 367

Sıkma Tork Değeri : S 367 / Tightening Torque : P 367 / Момент затяжки: стр. 367

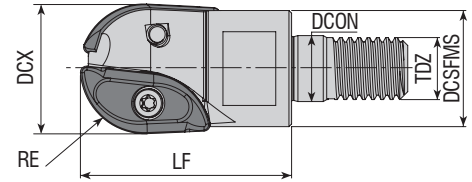

Takım Kodu Ordering Code Код для заказа	Stok Stock Наличие	Takım Ölçüleri (mm) Dimension (mm) Размеры (мм)						Kesici Uç Insert Пластина	Yedek Parçaları / Spare Parts / Запасные части		
		DCX	RE	DCSFMS	TDZ	LF	DCON		Sıkma Vidası Screw Зажимной винт	Tork Anahtar Torx Key Торх Ключ	
APMR-SWB225-D25-M12-L35	●	25	12.5	23.5	M12	35	12.5				
APMR-SWB230-D30-M16-L43	●	30	15	28	M16	43	17		4015-M4x9	80-T15	
APMR-SWB232-D32-M16-L43	●	32	16	30	M16	43	17				1020-M5x11

DJT Ucuna Uygundur. / Compatible with DJT Insert. / Под пластину SMTM-DJT

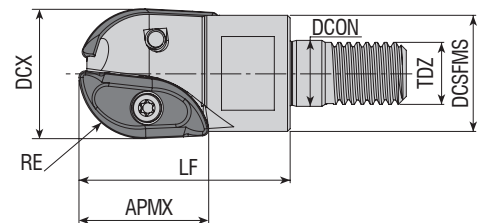

Takım Kodu Ordering Code Код для заказа	Stok Stock Наличие	Takım Ölçüleri (mm) Dimension (mm) Размеры (мм)							Kesici Uç Insert Пластина	Yedek Parçaları / Spare Parts / Запасные части		
		DCX	RE	DCSFMS	TDZ	LF	APMX	DCON		Sıkma Vidası Screw Зажимной винт	Tork Anahtar Torx Key Торх Ключ	
APMR-XP16-D16-M08-L25	●	16	8	14.75	M08	25	16	8.5				
APMR-XP20-D20-M10-L30	●	20	10	18	M10	30	20	10.5		3010-M3.5x7	80-T10	
APMR-XP25-D25-M12-L40	●	25	12.5	22	M12	40	25	12.5				4015-M4x9

R: Sağ / Right / Правый L: Sol / Left / Левый

● Stokta / In Stock / В наличии ○ Stokta Yok / Non Stock Item / Нет в наличии

ZCC Ucuna Uygundur. / Compatible with ZCC Insert. / Под пластину ZCC

Sipariş Örneği/Ordering Example/Образец заказа

1 ad./pcs./шт. APMR-SWB225-D25-M12-L35



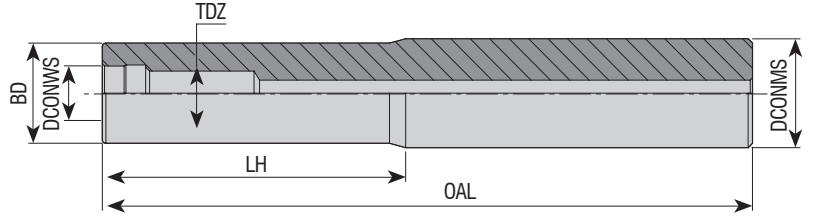

Kesme Hesabı : S 367 / Cutting Calculation : P 367 / Расчет режимов резания: стр. 367

Sıkma Tork Değeri : S 367 / Tightening Torque : P 367 / Момент затяжки: стр. 367

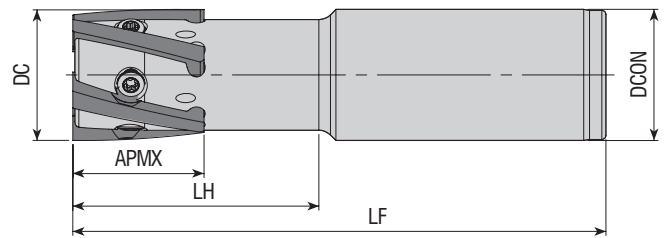

Takım Kodu Ordering Code Код для заказа	Stok Stock Наличие	Takım Ölçüleri (mm) Dimension (mm) Размеры (мм)					
		DCONMS	TDZ	DCONWS	BD	OAL	LH
AVTT-D13-C16-M08-L100-H	●	16	M08	8.5	13	100	40
AVTT-D15-C16-M08-L130-H	●	16	M08	8.5	15	130	70
AVTT-D18-C20-M10-L130-H	●	20	M10	10.5	18	130	70
AVTT-D18-C20-M10-L160-H	●	20	M10	10.5	18	160	80
AVTT-D23-C25-M12-L150-H	●	25	M12	12.5	23	150	70
AVTT-D23-C25-M12-L200-H	●	25	M12	12.5	23	200	100
AVTT-D23-C25-M12-L250-H	●	25	M12	12.5	23	250	150
AVTT-D30-C32-M16-L150-H	●	32	M16	17	30	150	70
AVTT-D30-C32-M16-L200-H	●	32	M16	17	30	200	100
AVTT-D30-C32-M16-L250-H	●	32	M16	17	30	250	150
AVTT-D30-C32-M16-L300-H	●	32	M16	17	30	300	200

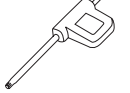

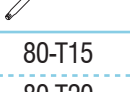
Takım Kodu Ordering Code Код для заказа	Stok Stock Наличие	Takım Ölçüleri (mm) Dimension (mm) Размеры (мм)						Kesici Uç Insert Пластина	Yedek Parçaları / Spare Parts / Залпасные части	
		DC	ZEFP	DCON	LF	LH	APMX		Sıkma Vidası Screw Зажимной Винт	Tork Anahtar Torx Key Торх Ключ
ATM-H23-D23-C25-L100-Z02-H	●	23	2	25	100	30	27			
ATM-H32-D32-C32-L130-Z05-H	●	32	5	32	130	35	32			

CPT Uçuna Uygundur. / Compatible with CPT Insert. / Под пластину CPT.

Sipariş Örneği/Ordering Example/Образец заказа

1 ad./pcs./шт. AVTT-D13-C16-M08-L100-H

Kesme Hesabı : S 367 / Cutting Calculation : P 367 / Расчет режимов резания: стр. 367

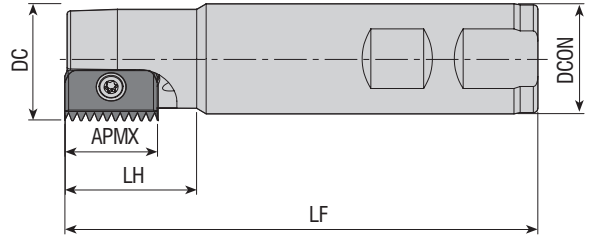

Takım Kodu Ordering Code Код для заказа	Stok Stock Наличие	Takım Ölçüleri (mm) Dimension (mm) Размеры (мм)						Kesici Uç Insert Пластина	Yedek Parçaları / Spare Parts / Запасные части		
		DC	ZAFP	DCON	LF	LH	APMX		Sıkma Vidası Screw Зажимной винт	Tork Anahtar Torx Key Торх Ключ	
ATM-C14-D14-W20-L100-Z01-H	●	14	1	20	100	25	14		3008-M2.5x6		
ATM-C21-D18-W20-L100-Z01-H	●	18	1	20	100	30	21		4015-M4x9		
ATM-C21-D21-W25-L125-Z01-H	●	21	1	25	125	40	21		4015-M4x11		
ATM-C21-D25-W20-L125-Z01-H	●	25	1	20	125	30	21				
ATM-C21-D28-W25-L90-Z01-H	●	28	1	25	90	30	21				
ATM-C21-D38-W32-L90-Z03-H	●	38	3	32	90	30	21				
ATM-C21-D38-W32-L120-Z03-H	●	38	3	32	120	30	21	C21	4015-M4x11	80-T15	
ATM-C21-D43-W32-L90-Z03-H	●	43	3	32	90	30	21				
ATM-C30-D29-W25-L150-Z01-H	●	29	1	25	150	50	30	C30	1020-M5x14	80-T20	

CPT Ucuna Uygunudur. / Compatible with CPT Insert. / Под пластину CPT.

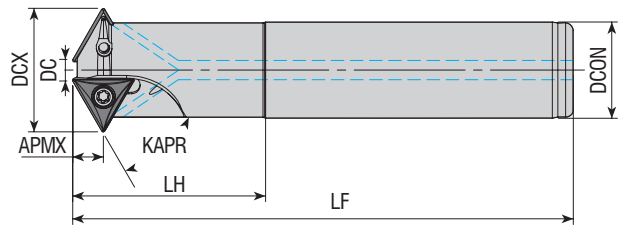

Takım Kodu Ordering Code Код для заказа	Stok Stock Наличие	Takım Ölçüleri (mm) Dimension (mm) Размеры (мм)								Kesici Uç Insert Пластина	Yedek Parçaları / Spare Parts / Запасные части		
		KAPR	DCX	DCON	DC	LF	LH	ZAFP	APMX		Sıkma Vidası Screw Зажимной винт	Tork Anahtar Torx Key Торх Ключ	
ATM60-TB0601-D13-C10-L150-Z02-H	●	60	13	10	2.5	150	40	2	3.3	TBGT 060102	3006-M2x4	80-T06	
ATM60-TC0902-D20.5-C16-L150-Z02-H	●	60	20.5	16	5.2	150	40	2	4.7	TC.T 090202	3007-M2.2x5	80-T07	
ATM60-TC1102-D26-C20-L150-Z03-H	●	60	26	20	8.3	150	50	3	5.4	TC.T 110202	3008-M2.5x6	80-T08	
ATM60-TC16T3-D32-C25-L150-Z02-H	●	60	32	25	6.4	150	50	2	8	TC.T 16T304	4015-M3.5x9	80-T15	
ATM60-TC16T3-D40-C32-L250-Z03-H	●	60	40	32	13.7	250	50	3	8				

R: Sağ / Right / Правый L: Sol / Left / Левый

● Stokta / In Stock / В наличии ○ Stokta Yok / Non Stock Item / Нет в наличии
 ISO Ucuna Uygunudur. / Compatible with ISO Insert. / Под пластину ISO.

Sipariş Örneği/Ordering Example/Образец заказа

1 ad./pcs./шт. ATM-C14-D14-W20-L100-Z01-H

Kesme Hesabı : S 367 / Cutting Calculation : P 367 / Расчет режимов резания: стр. 367

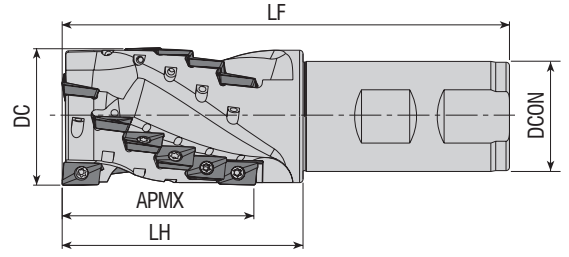

Takım Kodu Ordering Code Код для заказа	Stok Stock Наличие	Takım Ölçüleri (mm) Dimension (mm) Размеры (мм)							Kesici Uç Insert Пластина	Yedek Parçaları / Spare Parts / Запасные части		
		ZEFP		DC	DCON	APMX	LH	LF		Sıkma Vidası Screw Зажимной винт	Tork Anahtar Torx Key Торх Ключ	
		Toplam Total Gesamt	Etkili Effective Effektiv									
AHM90-AP10-D20-W20-L087-Z0204	●	4	2	20	20	28	37	87	AP. 1003..	3008-M2.5x6	80-T08	
AHM90-AP10-D20-W20-L087-Z0206	●	6	2	20	20	28	37	87				
AHM90-AP10-D25-W25-L105-Z0208-H	●	8	2	25	25	37	50	105				
AHM90-AP10-D32-W32-L115-Z0315-H	●	15	3	32	32	46	55	115				
AHM90-AP10-D40-W32-L130-Z0318-H	●	18	3	40	32	55	70	130				

ISO Ucuna Uygundur. / Compatible with ISO Insert. / Под пластину ISO.

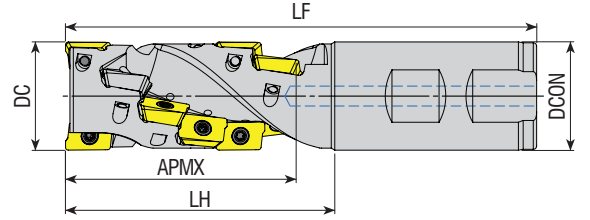

Takım Kodu Ordering Code Код для заказа	Stok Stock Наличие	Takım Ölçüleri (mm) Dimension (mm) Размеры (мм)							Kesici Uç Insert Пластина	Yedek Parçaları / Spare Parts / Запасные части		
		ZEFP		DC	DCON	APMX	LH	LF		Sıkma Vidası Screw Зажимной винт	Tork Anahtar Torx Key Торх Ключ	
		Toplam Total Gesamt	Etkili Effective Effektiv									
AHM90-AP1204-D32-W32-L140-Z0212-H	●	12	2	32	32	68	80	140	AP. 1204..	3010-M3.5x9	80-T10	
AHM90-AP1204-D40-W32-L160-Z0321-H	●	21	3	40	32	79	100	160				

R: Sağ / Right / Правый L: Sol / Left / Левый

● Stokta / In Stock / В наличии ○ Stokta Yok / Non Stock Item / Нет в наличии

TGTC Ucuna Uygundur. / Compatible with TGTC Insert. / Под пластину TGTC.

Sipariş Örneği/Ordering Example/Образец заказа

1 ad./pcs./шт. AHM90-AP10-D20-W20-L087-Z0204

Kesme Hesabı : S 367 / Cutting Calculation : P 367 / Расчет режимов резания: стр. 367

konusulan
the spoken kalite...
quality...



KAPR=42°

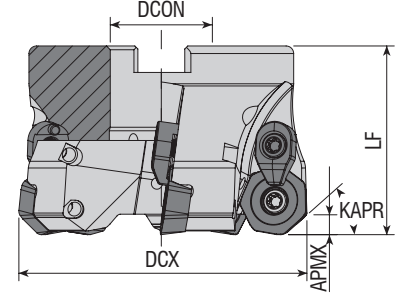

Takım Kodu Ordering Code Код для заказа	Stok Stock Наличие	Takım Ölçüleri (mm) Dimension (mm) Размеры (мм)					Kesici Uç Insert Пластина	Sıkma Vidası Screw Зажимной винт	Baskı Parçası Wedge Clamp Прижим	Baskı Vidası Clamp Screw Зажимной винт	Tork Anahtar Torx Key Торх Ключ	Montaj Vidası Mounting Screw Монтажный винт
		DCX	ZEFP	DCON	LF	APMX						
AFM42C-XD0806-D063-A27-Z04-H	●	63	4	27	50	12	XDMW 0806..	4020-M4.5x12	ACK-24	4020-M4.5x12	80-T20	2510-M12x35
AFM42C-XD0806-D080-A27-Z05-H	●	80	5	27	50	12						
AFM42C-XD0806-D100-A32-Z06-H	●	100	6	32	63	12						-
AFM42C-XD0806-D125-B40-Z07	●	125	7	40	63	12						
AFM42C-XD0806-D160-C40-Z08	●	160	8	40	63	12						
AFM42C-XD0806-D200-C60-Z09	●	200	9	60	63	12						

DJT Ucuna Uygunudur. / Compatiple with DJT Insert. / Под пластину DJT

KAPR=43°

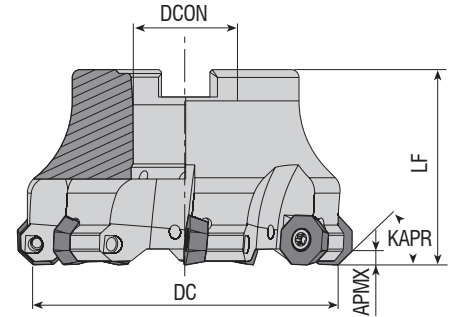

Takım Kodu Ordering Code Код для заказа	Stok Stock Наличие	Takım Ölçüleri (mm) Dimension (mm) Размеры (мм)					Kesici Uç Insert Пластина	Sıkma Vidası Screw Зажимной винт	Tork Anahtar Torx Key Торх Ключ	Montaj Vidası Mounting Screw Монтажный винт
		DC	ZEFP	DCON	LF	APMX				
AFM43-OD0504-D040-A16-Z04-H	●	40	4	16	40	3.5	OD.. 0504..	4015-M3.5x11	80-T15	2506-M8x30
AFM43-OD0504-D050-A22-Z05-H	●	50	5	22	40	3.5				2407-M10x30
AFM43-OD0504-D063-A22-Z06-H	●	63	6	22	40	3.5				2510-M12x35
AFM43-OD0504-D080-A27-Z07-H	●	80	7	27	50	3.5				
AFM43-OD0504-D100-A32-Z08-H	●	100	8	32	50	3.5				

R: Sağ / Right / Правый L: Sol / Left / Левый

● Stokta / In Stock / В наличии ○ Stokta Yok / Non Stock Item / Нет в наличии
WLTR Ucuna Uygunudur. / Compatiple with WLTR Insert. / Под пластину WLTR

Sipariş Örneği/Ordering Example/Bestellbeispiel

1 ad./pcs./шт. AFM42C-XD0806-D063-A27-Z04-H

Kesme Hesabı : S 367 / Cutting Calculation : P 367 / Расчет режимов резания: стр. 367

Montaj Ölçüleri : S 364 / Mounting Reference : P 364 / Инструкция по установке фрез: стр. 364

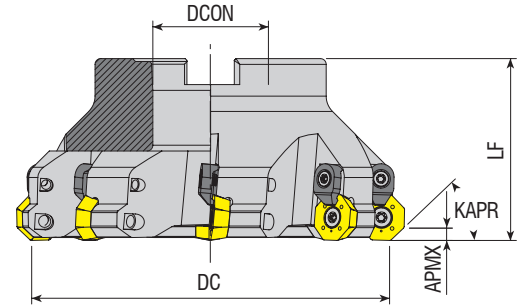

Takım Kodu Ordering Code Код для заказа	Stok Stock Наличие	Takım Ölçüleri (mm) Dimension (mm) Размеры (мм)					Kesici Uç Insert Пластина	Yedek Parçaları / Spare Parts / Запасные части					
		DC	ZEFP	DCON	LF	APMX		Sıkma Vidası Screw Зажимной винт	Baskı Parçası Wedge Clamp Прижим	Baskı Vidası Clamp Screw Зажимной винт	Tork Anahtar Torx Key Торх Ключ	Montaj Vidası Mounting Screw Монтажный винт	
AFM43C-OD0605-D080-A27-Z06-H	●	80	6	27	50	4	OD.. 0605..		ACK-05	4015-M4x11	80-T20	2510-M12x35	
AFM43C-OD0605-D100-A32-Z07-H	●	100	7	32	50	4						1020-M5x11	2514-M16x35
AFM43C-OD0605-D125-B40-Z08	●	125	8	40	63	4						-	

WLTR-LMN Ucuna Uygundur. / Compatible with WLTR-LMN Insert. / Под пластину WLTR-LMN

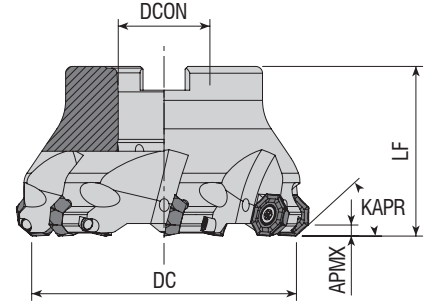

Takım Kodu Ordering Code Код для заказа	Stok Stock Наличие	Takım Ölçüleri (mm) Dimension (mm) Размеры (мм)					Kesici Uç Insert Пластина	Yedek Parçaları / Spare Parts / Запасные части			
		DC	ZEFP	DCON	LF	APMX		Sıkma Vidası Screw Зажимной винт	Tork Anahtar Torx Key Торх Ключ	Montaj Vidası Mounting Screw Монтажный винт	
AFM43-OF05T3-D050-A22-Z05-H	●	50	5	22	40	3	OF. 05T3..		80-T15	2407-M10x30	
AFM43-OF05T3-D063-A22-Z06-H	●	63	6	22	40	3				4015-M4x9	2510-M12x35
AFM43-OF05T3-D080-A27-Z07-H	●	80	7	27	50	3				4015-M4x11	-
AFM43-OF05T3-D125-B40-Z09	●	125	9	40	63	3				-	

R: Sağ / Right / Правый L: Sol / Left / Левый

● Stokta / In Stock / В наличии ○ Stokta Yok / Non Stock Item / Нет в наличии
ISO Ucuna Uygundur. / Compatible with ISO Insert. / Под пластину ISO

Sipariş Örneği/Ordering Example/Bestellbeispiel
1 ad./pcs./шт. AFM43C-OD0605-D080-A27-Z06-H

Kesme Hesabı : S 367 / Cutting Calculation : P 367 / Расчет режимов резания: стр. 367
Montaj Ölçüleri : S 364 / Mounting Reference : P 364 / Инструкция по установке фрез: стр. 364

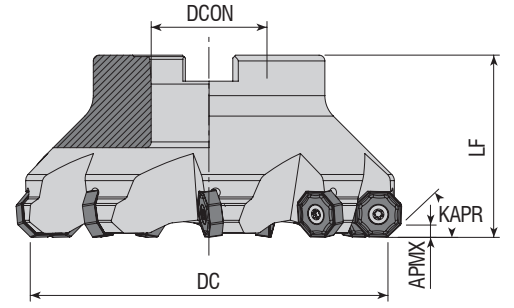

Takım Kodu Ordering Code Код для заказа	Stok Stock Наличие	Takım Ölçüleri (mm) Dimension (mm) Размеры (мм)					Kesici Uç Insert Пластина	Yedek Parçaları / Spare Parts / Запасные части					
		DC	ZAFP	DCON	LF	APMX		Sıkma Vidası Screw Зажимной винт	Tork Anahtar Torx Key Торх Ключ	Montaj Vidası Mounting Screw Монтажный винт			
AFM43-ON0604-D050-A22-Z05-H	●	50	5	22	40	4	ON.. 0604..		4015-M4x11	80-T15			
AFM43-ON0604-D063-A22-Z06-H	●	63	6	22	40	4							2407-M10x30
AFM43-ON0604-D080-A27-Z07-H	●	80	7	27	50	4							2510-M12x35
AFM43-ON0604-D100-A32-Z08-H	●	100	8	32	50	4							2514-M16x35
AFM43-ON0604-D125-B40-Z09	●	125	9	40	63	4							-

ZCC Ucuna Uygundur. / Compatible with ZCC Insert. / Под пластину HRN

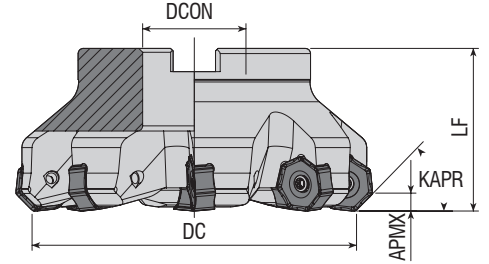

Takım Kodu Ordering Code Код для заказа	Stok Stock Наличие	Takım Ölçüleri (mm) Dimension (mm) Размеры (мм)					Kesici Uç Insert Пластина	Yedek Parçaları / Spare Parts / Запасные части					
		DC	ZAFP	DCON	LF	APMX		Sıkma Vidası Screw Зажимной винт	Tork Anahtar Torx Key Торх Ключ	Montaj Vidası Mounting Screw Монтажный винт			
AFM44-ON0606-D063-A22-Z06-H	●	63	6	22	40	3.8	ONHX 0606..		4020-M4.5x12	80-T20			
AFM44-ON0606-D080-A27-Z08-H	●	80	8	27	50	3.8							2407-M10x30
AFM44-ON0606-D100-A32-Z10-H	●	100	10	32	50	3.8							2510-M12x35
												2514-M16x35	

R: Sağ / Right / Правый L: Sol / Left / Левый
● Stokta / In Stock / В наличии ○ Stokta Yok / Non Stock Item / Нет в наличии
KRLY Ucuna Uygundur. / Compatible with KRLY Insert./Под пластину KRYL.

Sipariş Örneği/Ordering Example/Bestellbeispiel
1 ad./pcs./шт. AFM43-ON0604-D050-A22-Z05-H
Kesme Hesabı : S 367 / Cutting Calculation : P 367 / Расчет режимов резания: стр. 367
Montaj Ölçüleri : S 364 / Mounting Reference : P 364 / Инструкция по установке фрез: стр. 364

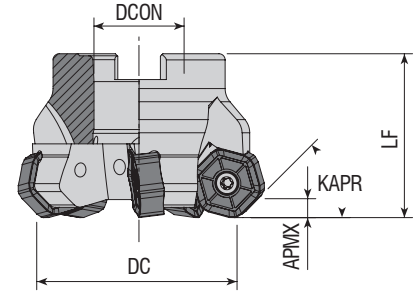

Takım Kodu Ordering Code Код для заказа	Stok Stock Наличие	Takım Ölçüleri (mm) Dimension (mm) Размеры (мм)					Kesici Uç Insert Пластина	Yedek Parçaları / Spare Parts / Запасные части		
		DC	ZEFP	DCON	LF	APMX		Sıkma Vidası Screw Зажимной винт	Tork Anahtar Torx Key Торх Ключ	Montaj Vidası Mounting Screw Монтажный винт
AFM45-HN0905-D050-A22-Z05-H	●	50	5	22	40	4.5	HN.. 0905..	4015-M4x11	80-T15	2407-M10x30
AFM45-HN0905-D063-A22-Z06-H	●	63	6	22	40	4.5				2510-M12x35
AFM45-HN0905-D080-A27-Z07-H	●	80	7	27	50	4.5				2514-M16x35
AFM45L-HN0905-D100-A32-Z08-H	●	100	8	32	50	4.5				-
AFM45-HN0905-D125-B40-Z10	●	125	10	40	63	4.5				
AFM45L-HN0905-D125-B40-Z10	●	125	10	40	63	4.5				
AFM45-HN0905-D160-C40-Z12	●	160	12	40	63	4.5				
AFM45L-HN0905-D160-C40-Z12	●	160	12	40	63	4.5				
AFM45-HN0905-D200-C60-Z16	●	200	16	60	63	4.5				
AFM45L-HN0905-D200-C60-Z16	●	200	16	60	63	4.5				

WDA Ucuna Uygunudur. / Compatible with WDA Insert. / Под пластину WDA

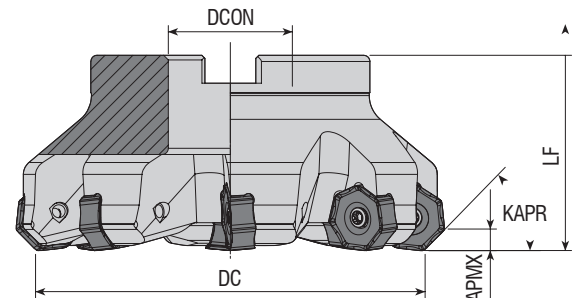

Takım Kodu Ordering Code Код для заказа	Stok Stock Наличие	Takım Ölçüleri (mm) Dimension (mm) Размеры (мм)					Kesici Uç Insert Пластина	Yedek Parçaları / Spare Parts / Запасные части		
		DC	ZEFP	DCON	LF	APMX		Sıkma Vidası Screw Зажимной винт	Tork Anahtar Torx Key Торх Ключ	Montaj Vidası Mounting Screw Монтажный винт
AFM45-NN2007-D100-A32-Z07-H	●	100	7	32	50	6	NNMU 2007..	1020-M5x14	80-T20	2514-M16x35
AFM45-NN2007-D125-B40-Z08	●	125	8	40	63	6				
AFM45-NN2007-D160-C40-Z10	●	160	10	40	63	6				

R: Sağ / Right / Правый L: Sol / Left / Левый

● Stokta / In Stock / В наличии ○ Stokta Yok / Non Stock Item / Нет в наличии

MTSBH Ucuna Uygunudur. / Compatible with MTSBH Insert. / Под пластину MTSBH

Sipariş Örneği/Ordering Example/Bestellbeispiel

1 ad./pcs./шт. AFM45-HN0905-D063-A22-Z06-H

Kesme Hesabı : S 367 / Cutting Calculation : P 367 / Расчет режимов резания: стр. 367

Montaj Ölçüleri : S 364 / Mounting Reference : P 364 / Инструкция по установке фрез: стр. 364

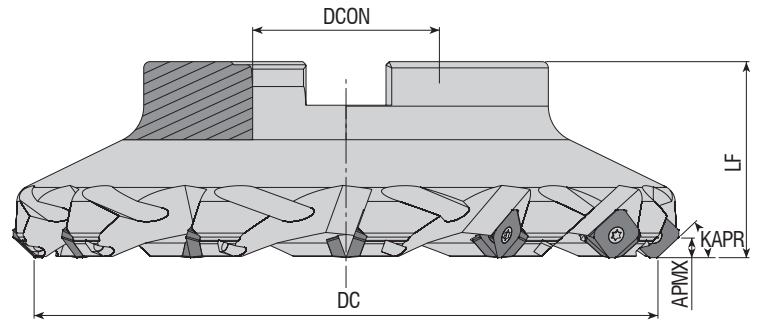

Takım Kodu Ordering Code Код для заказа	Stok Stock Наличие	Takım Ölçüleri (mm) Dimension (mm) Размеры (мм)					Kesici Uç Insert Пластина	Yedek Parçaları / Spare Parts / Запасные части			
		DC	ZEFP	DCON	LF	APMX		Sıkma Vidası Screw Зажимной винт	Tork Anahtar Torx Key Торх Ключ	Montaj Vidası Mounting Screw Монтажный винт	
AFM45-SE12-D050-A22-Z04-H	●	50	4	22	40	6	SE.. 12T3.. R245-12T3..	4015-M3.5x11	80-T15	2407-M10x30	
AFM45L-SE12-D050-A22-Z04-H	●	50	4	22	40	6					
AFM45-SE12-D063-A22-Z05-H	●	63	5	22	40	6					
AFM45L-SE12-D063-A22-Z05-H	●	63	5	22	40	6					
AFM45-SE12-D080-A27-Z06-H	●	80	6	27	50	6					
AFM45L-SE12-D080-A27-Z06-H	●	80	6	27	50	6					
AFM45-SE12-D100-A32-Z07-H	●	100	7	32	50	6					
AFM45-SE12-D125-B40-Z08	●	125	8	40	63	6					
AFM45-SE12-D160-C40-Z10	●	160	10	40	63	6					
AFM45L-SE12-D160-C40-Z10	●	160	10	40	63	6					
AFM45-SE12-D200-C60-Z12	●	200	12	60	63	6					

ZCC-SNDVK Ucuna Uygundur. / Compatible with ZCC-SNDVK Insert. / Под пластину ZCC-SNDVK.

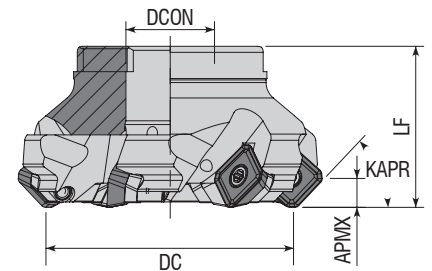

Takım Kodu Ordering Code Код для заказа	Stok Stock Наличие	Takım Ölçüleri (mm) Dimension (mm) Размеры (мм)					Kesici Uç Insert Пластина	Yedek Parçaları / Spare Parts / Запасные части				
		DC	ZEFP	DCON	LF	APMX		Altlık Screw Unterlage	Altlık Vidası Wedge Clamp Винт опорной пластины	Sıkma Vidası Screw Зажимной винт	Tork Anahtar Torx Key Торх Ключ	Montaj Vidası Mounting Screw Монтажный винт
AFM45-SE13-D050-A22-Z04-H	●	50	4	22	40	6	SEMT 13T3..	AASE-3-0001	AAV-16-M3.5x8	4015-M3.5x12	80-T15	2407-M10x30
AFM45-SE13-D063-A22-Z05-H	●	63	5	22	40	6						
AFM45-SE13-D080-A27-Z06-H	●	80	6	27	50	6						
AFM45S-SE13-D050-A22-Z05-H	●	50	5	22	40	6						
AFM45S-SE13-D063-A22-Z06-H	●	63	6	22	40	6						
AFM45S-SE13-D080-A27-Z08-H	●	80	8	27	50	6						
AFM45S-SE13-D100-A32-Z10-H	●	100	10	32	50	6						
AFM45S-SE13-D125-B40-Z12	●	125	12	40	63	6						

R: Sağ / Right / Правый L: Sol / Left / Левый

● Stokta / In Stock / В наличии ○ Stokta Yok / Non Stock Item / Нет в наличии

SMTM-DJT Ucuna Uygundur. / Compatible with SMTM-DJT Insert. / Под пластину SMTM-DJT.

Sipariş Örneği/Ordering Example/Bestellbeispiel

1 ad./pcs./шт. AFM45-SE12-D050-A22-Z04-H

Kesme Hesabı : S 367 / Cutting Calculation : P 367 / Расчет режимов резания: стр. 367

Montaj Ölçüleri : S 364 / Mounting Reference : P 364 / Инструкция по установке фрез: стр. 364

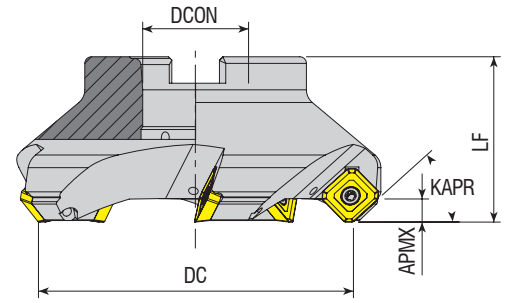

Takım Kodu Ordering Code Код для заказа	Stok Stock Наличие	Takım Ölçüleri (mm) Dimension (mm) Размеры (мм)					Kesici Uç Insert Пластина	Yedek Parçaları / Spare Parts / Запасные части			
		DC	ZEFP	DCON	LF	APMX		Sıkma Vidası Screw Зажимной винт	Tork Anahtar Torx Key Торх Ключ	Montaj Vidası Mounting Screw Монтажный винт	
AFM45-SE14M4-D063-A22-Z04-H	●	63	4	22	40	7	SE.. 14M4..	4015-M3.5x11	80-T15	2407-M10x30 2510-M12x35 2514-M16x35	
AFM45-SE14M4-D080-A27-Z05-H	●	80	5	27	50	7					
AFM45-SE14M4-D100-A32-Z05-H	●	100	5	32	50	7					
AFM45-SE14M4-D125-B40-Z06	●	125	6	40	63	7					
AFM45-SE14M4-D160-C40-Z07	●	160	7	40	63	7					

KRLY Ucuna Uygun. / Compatible with KRLY Insert. / Под пластину KRYL.

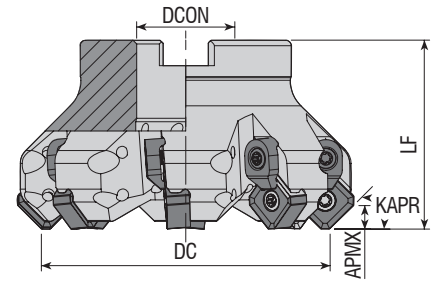

Takım Kodu Ordering Code Код для заказа	Stok Stock Наличие	Takım Ölçüleri (mm) Dimension (mm) Размеры (мм)					Kesici Uç Insert Пластина	Yedek Parçaları / Spare Parts / Запасные части				
		DC	ZEFP	DCON	LF	APMX		Sıkma Vidası Screw Зажимной винт	Baskı Parçası Wedge Clamp Прижим	Baskı Vidası Clamp Screw Зажимной винт	Tork Anahtar Torx Key Торх Ключ	Montaj Vidası Mounting Screw Монтажный винт
AFM45C-SN12..-D050-A22-Z04-H	●	50	4	22	42	6	SN.. 12..	1015-M4x11	ACK-05	4015-M4x11	80-T15	2407-M10x30 2510-M12x35 2514-M16x35
AFM45C-SN12..-D050-A22-Z05-H	●	50	5	22	42	6						
AFM45C-SN12..-D063-A22-Z06-H	●	63	6	22	42	6						
AFM45C-SN12..-D063-A22-Z07-H	●	63	7	22	42	6						
AFM45CL-SN12..-D063-A22-Z07-H	●	63	7	22	42	6						
AFM45C-SN12..-D080-A27-Z07-H	●	80	7	27	52	6						
AFM45C-SN12..-D080-A27-Z08-H	●	80	8	27	52	6						
AFM45CL-SN12..-D080-A27-Z08-H	●	80	8	27	52	6						
AFM45C-SN12..-D100-A32-Z08-H	●	100	8	32	52	6						
AFM45C-SN12..-D100-A32-Z10-H	●	100	10	32	52	6						
AFM45CL-SN12..-D100-A32-Z10-H	●	100	10	32	52	6						
AFM45C-SN12..-D125-B40-Z11	●	125	11	40	65	6						
AFM45CL-SN12..-D125-B40-Z11	●	125	11	40	65	6						
AFM45C-SN12..-D160-C40-Z12	●	160	12	40	65	6						
AFM45C-SN12..-D200-C60-Z14	●	200	14	60	65	6						
AFM45CL-SN12..-D200-C60-Z14	●	200	14	60	65	6						

R: Sağ / Right / Правый L: Sol / Left / Левый

● Stokta / In Stock / В наличии ○ Stokta Yok / Non Stock Item / Нет в наличии

WLTR-LMN-ACHTK Ucuna Uygun. / Compatible with WLTR-LMN-ACHTK Insert. / Под пластину WLTR-LMN-ACHTK
Montaj Ölçüleri : S 364 / Mounting Reference : P 364 / Инструкция по установке фрез: стр. 364

Sipariş Örneği/Ordering Example/Bestellbeispiel

1 ad./pcs./шт. AFM45-SE14M4-D063-A22-Z04-H

Kesme Hesabı : S 367 / Cutting Calculation : P 367 / Расчет режимов резания: стр. 367

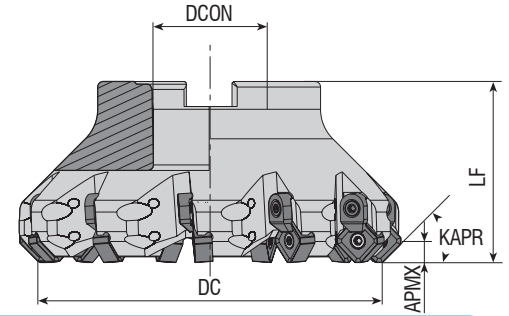

Takım Kodu Ordering Code Код для заказа	Stok Stock Наличие	Takım Ölçüleri (mm) Dimension (mm) Размеры (мм)					Kesici Uç Insert Пластина	Yedek Parçaları / Spare Parts / Запасные части				
		DC	ZEFP	DCON	LF	APMX		Sıkma Vidası Screw Зажимной винт	Baskı Parçası Wedge Clamp Прижим	Baskı Vidası Clamp Screw Зажимной винт	Tork Anahtar Torx Key Торх Ключ	Montaj Vidası Mounting Screw Монтажный винт
AFM45C-SN1206-D050-A22-Z04-H	●	50	4	22	42	6	SN.. 1206..	4015-M4x11	ACK-05	4015-M4x11	80-T15	2407-M10x30
AFM45CL-SN1206-D050-A22-Z05-H	●	50	5	22	42	6						
AFM45C-SN1206-D050-A22-Z05-H	●	50	5	22	42	6						
AFM45C-SN1206-D063-A22-Z06-H	●	63	6	22	42	6						
AFM45C-SN1206-D063-A22-Z07-H	●	63	7	22	42	6						
AFM45CL-SN1206-D063-A22-Z07-H	●	63	7	22	42	6						
AFM45C-SN1206-D080-A27-Z07-H	●	80	7	27	52	6						
AFM45C-SN1206-D080-A27-Z08-H	●	80	8	27	52	6						
AFM45CL-SN1206-D080-A27-Z08-H	●	80	8	27	52	6						
AFM45C-SN1206-D100-A32-Z08-H	●	100	8	32	52	6						
AFM45C-SN1206-D100-A32-Z10-H	●	100	10	32	52	6						
AFM45CL-SN1206-D100-A32-Z10-H	●	100	10	32	52	6						
AFM45C-SN1206-D125-B40-Z11	●	125	11	40	65	6						
AFM45CL-SN1206-D125-B40-Z11	●	125	11	40	65	6						
AFM45C-SN1206-D160-C40-Z12	●	160	12	40	65	6						
AFM45C-SN1206-D200-C60-Z14	●	200	14	60	65	6						
AFM45CL-SN1206-D200-C60-Z14	●	200	14	60	65	6						

KRLY-PLBT-BHLR Uçuna Uygunur. / Compatible with KRLY-PLBT-BHLR Insert. / Под пластину KRLY-PLBT-BHLR

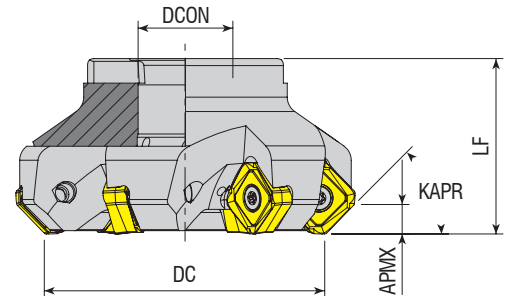

Takım Kodu Ordering Code Код для заказа	Stok Stock Наличие	Takım Ölçüleri (mm) Dimension (mm) Размеры (мм)					Kesici Uç Insert Пластина	Yedek Parçaları / Spare Parts / Запасные части		
		DC	ZEFP	DCON	LF	APMX		Sıkma Vidası Screw Зажимной винт	Tork Anahtar Torx Key Торх Ключ	Montaj Vidası Mounting Screw Монтажный винт
AFM45-SA1706-D080-A27-Z06-H	●	80	6	27	50	8.4	SAKU 1706..	1020-M5x14	80-T20	2510-M12x35
AFM45-SA1706-D100-A32-Z07-H	●	100	7	32	50	8.4				2514-M16x35
AFM45-SA1706-D125-B40-Z09	●	125	9	40	63	8.4				-

R: Sağ / Right / Правый L: Sol / Left / Левый

● Stokta / In Stock / В наличии ○ Stokta Yok / Non Stock Item / Нет в наличии

CRTZT Uçuna Uygunur. / Compatible with CRTZT Insert. / Под пластину CRTZT

Sipariş Örneği/Ordering Example/Bestellbeispiel

1 ad./pcs./шт. AFM45C-SN1206-D050-A22-Z04-H

Kesme Hesabı : S 367 / Cutting Calculation : P 367 / Расчет режимов резания: стр. 367

Montaj Ölçüleri : S 364 / Mounting Reference : P 364 / Инструкция по установке фрез: стр. 364

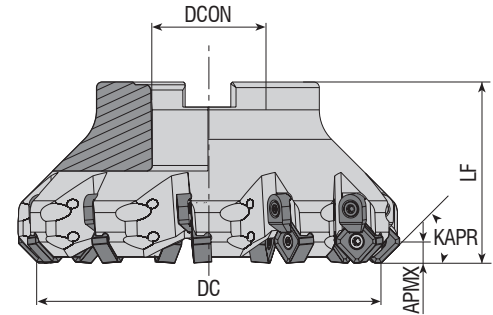

Takım Kodu Ordering Code Код для заказа	Stok Stock Наличие	Takım Ölçüleri (mm) Dimension (mm) Размеры (мм)					Kesici Uç Insert Пластина	Yedek Parçaları / Spare Parts / Запасные части					
		DC	ZEFP	DCON	LF	APMX		Sıkma Vidası Screw Зажимной винт	Baskı Parçası Wedge Clamp Прижим	Baskı Vidası Clamp Screw Зажимной винт	Tork Anahtar Torx Key Торх Ключ	Montaj Vidası Mounting Screw Монтажный винт	
AFM45C-SN12Z-D050-A22-Z05-H	●	50	5	22	42	6	SNEG 1205..						
AFM45C-SN12Z-D063-A22-Z06-H	●	63	6	22	42	6							2407-M10X30
AFM45C-SN12Z-D080-A27-Z07-H	●	80	7	27	52	6							2510-M12x35
AFM45C-SN12Z-D100-A32-Z09-H	●	100	9	32	52	6							2514-M16x35
AFM45C-SN12Z-D125-B40-Z11	●	125	11	40	65	6							-
AFM45C-SN12Z-D160-C40-Z12	●	160	12	60	65	6							-
AFM45C-SN12Z-D200-C60-Z14	●	200	14	60	65	6							-

ZCC Ucuna Uygundur. / Compatible with ZCC Insert. / Под пластину HRN

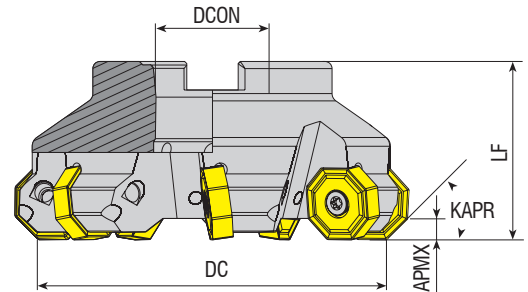

Takım Kodu Ordering Code Код для заказа	Stok Stock Наличие	Takım Ölçüleri (mm) Dimension (mm) Размеры (мм)					Kesici Uç Insert Пластина	Yedek Parçaları / Spare Parts / Запасные части			
		DC	ZEFP	DCON	LF	APMX		Sıkma Vidası Screw Зажимной винт	Tork Anahtar Torx Key Торх Ключ	Montaj Vidası Mounting Screw Монтажный винт	
AFM45-ON0806-D063-A22-Z05-H	●	63	5	22	40	5.5					
AFM45-ON0806-D063-A22-Z06-H	●		6	22	40	5.5					2508-M10x30
AFM45-ON0806-D080-A27-Z06-H	●		6	27	50	5.5					2510-M12x35
AFM45-ON0806-D080-A27-Z08-H	●		8	27	50	5.5					
AFM45-ON0806-D100-A32-Z07-H	●		7	32	50	5.5					
AFM45-ON0806-D100-A32-Z10-H	●		10	32	50	5.5					2514-M16x35
AFM45-ON0806-D125-B40-Z08	●		8	40	63	5.5					
AFM45-ON0806-D125-B40-Z12	●		12	40	63	5.5					
AFM45-ON0806-D160-C40-Z10	●		10	40	63	5.5					-
AFM45-ON0806-D160-C40-Z14	●		14	40	63	5.5					
AFM45-ON0806-D200-C60-Z12	●		12	60	63	5.5					
AFM45-ON0806-D250-C60-Z14	●		14	60	63	5.5					-
AFM45-ON0806-D315-D60-Z16	●		16	60	63	5.5					

R: Sağ / Right / Правый L: Sol / Left / Левый

● Stokta / In Stock / В наличии ○ Stokta Yok / Non Stock Item / Нет в наличии

ISO Ucuna Uygundur. / Compatible with ISO Insert. / Под пластину ISO

Sipariş Örneği/Ordering Example/Bestellbeispiel

1 ad./pcs./шт. AFM45C-SN12Z-D050-A22-Z05-H

Kesme Hesabı : S 367 / Cutting Calculation : P 367 / Расчет режимов резания: стр. 367

Montaj Ölçüleri : S 364 / Mounting Reference : P 364 / Инструкция по установке фрез: стр. 364

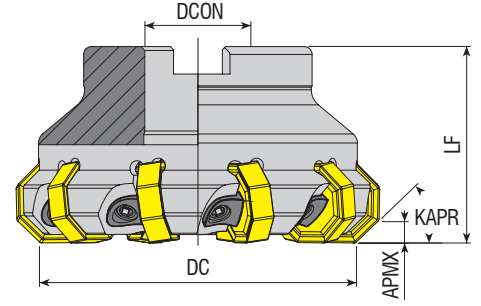

Takım Kodu Ordering Code Код для заказа	Stok Stock Наличие	Takım Ölçüleri (mm) Dimension (mm) Размеры (мм)					Kesici Uç Insert Пластина	Yedek Parçaları / Spare Parts / Запасные части				
		DC	ZEFP	DCON	LF	APMX		Baskı Parçası Wedge Clamp Прижим	Baskı Vidası Clamp Screw Зажимной винт	Anahtar Allen Key Ключ	Montaj Vidası Mounting Screw Монтажный винт	
AFM45C-ON0806-D080-A27-Z10	●	80	10	27	50	5.5	ON.. 0806..	ACK-26	AKV-26-M6x0.75x20	AAL-03-3		2510-M12x35
AFM45C-ON0806-D100-A32-Z14	●	100	14	32	50	5.5						2514-M16x35
AFM45C-ON0806-D125-B40-Z18	●	125	18	40	63	5.5						-
AFM45C-ON0806-D160-C40-Z22	●	160	22	40	63	5.5						-

ISO Ucuna Uygundur. / Compatiple with ISO Insert. / Под пластину ISO

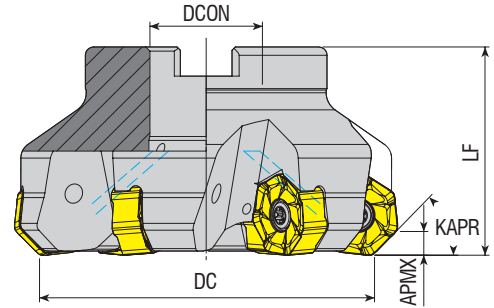

Takım Kodu Ordering Code Код для заказа	Stok Stock Наличие	Takım Ölçüleri (mm) Dimension (mm) Размеры (мм)					Kesici Uç Insert Пластина	Yedek Parçaları / Spare Parts / Запасные части				
		DC	ZEFP	DCON	LF	APMX		Sıkma Vidası Screw Зажимной винт	Baskı Parçası Wedge Clamp Прижим	Baskı Vidası Clamp Screw Зажимной винт	Tork Anahtar Torx Key Торх Ключ	Montaj Vidası Mounting Screw Монтажный винт
AFM45-XN0906-D063-A22-Z06-H	●	63	6	22	50	5	XNMU 0906..	1120-M5x13	-	-	80-T20	2407-M10x30
AFM45-XN0906-D080-A27-Z06-H	●	80	6	27	50	5						2510-M12x35
AFM45-XN0906-D100-A32-Z07-H	●	100	7	32	55	5						2514-M16x35
AFM45-XN0906-D125-B40-Z08	●	125	8	40	63	5						-

R: Sağ / Right / Правый L: Sol / Left / Левый
● Stokta / In Stock / В наличии ○ Stokta Yok / Non Stock Item / Нет в наличии
TGTC Ucuna Uygundur. / Compatiple with TGTC Insert. / Под пластину TGTC

Sipariş Örneği/Ordering Example/Bestellbeispiel
1 ad./pcs./шт. AFM45C-ON0806-D080-A27-Z10
Kesme Hesabı : S 367 / Cutting Calculation : P 367 / Расчет режимов резания: стр. 367
Montaj Ölçüleri : S 364 / Mounting Reference : P 364 / Инструкция по установке фрез: стр. 364

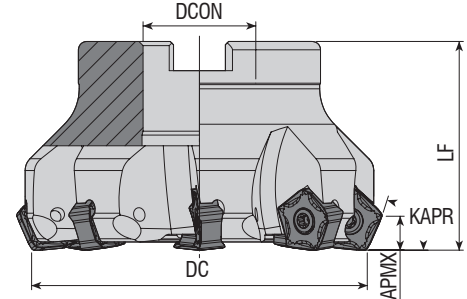

Takım Kodu Ordering Code Код для заказа	Stok Stock Наличие	Takım Ölçüleri (mm) Dimension (mm) Размеры (мм)					Kesici Uç Insert Пластина	Yedek Parçaları / Spare Parts / Запасные части				
		DC	ZEFP	DCON	LF	APMX		Sıkma Vidası Screw Зажимной винт	Tork Anahtar Torx Key Торх Ключ	Montaj Vidası Mounting Screw Монтажный винт		
AFM66-PN0905-D050-A22-Z05	●	50	5	22	40	8	PNMU 0905..		80-T15			
AFM66-PN0905-D063-A22-Z06	●	63	6	22	40	8						2508-M10x30
AFM66-PN0905-D080-A27-Z08	●	80	8	27	50	8						2510-M12x35
AFM66-PN0905-D100-A32-Z10	●	100	10	32	50	8						2514-M16x35
AFM66-PN0905-D125-B40-Z12	●	125	12	40	63	8						-

KYCR Ucuna Uygundur. / Compatible with KYCR Insert. / Под пластину KYCR

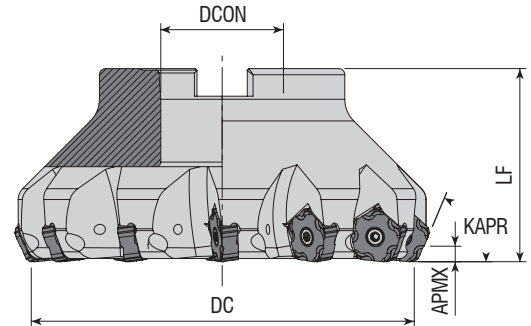

Takım Kodu Ordering Code Код для заказа	Stok Stock Наличие	Takım Ölçüleri (mm) Dimension (mm) Размеры (мм)					Kesici Uç Insert Пластина	Yedek Parçaları / Spare Parts / Запасные части				
		DC	ZEFP	DCON	LF	APMX		Sıkma Vidası Screw Зажимной винт	Tork Anahtar Torx Key Торх Ключ	Montaj Vidası Mounting Screw Монтажный винт		
AFM67-PN1105-D050-A22-Z05	●	50	5	22	50	5	PNEG 1105..		80-T15			
AFM67-PN1105-D063-A22-Z06	●	63	6	22	50	5						2508-M10x30
AFM67-PN1105-D080-A27-Z08	●	80	8	27	50	5						2510-M12x35
AFM67-PN1105-D100-B32-Z10	●	100	10	32	50	5						-
AFM67-PN1105-D125-B40-Z12	●	125	12	40	63	5						-
AFM67-PN1105-D160-C40-Z14	●	160	14	40	63	5	-					

R: Sağ / Right / Правый L: Sol / Left / Левый
● Stokta / In Stock / В наличии ○ Stokta Yok / Non Stock Item / Нет в наличии
ZCC Ucuna Uygundur. / Compatible with ZCC Insert. / Под пластину HRN

Sipariş Örneği/Ordering Example/Bestellbeispiel
1 ad./pcs./шт. AFM66-PN0905-D050-A22-Z05

Kesme Hesabı : S 367 / Cutting Calculation : P 367 / Расчет режимов резания: стр. 367
Montaj Ölçüleri : S 364 / Mounting Reference : P 364 / Инструкция по установке фрез: стр. 364

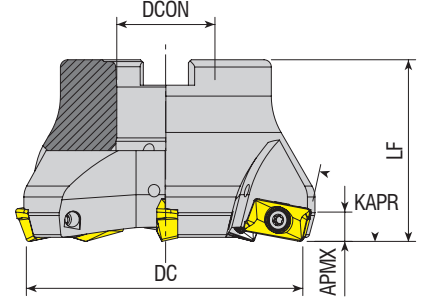

Takım Kodu Ordering Code Код для заказа	Stok Stock Наличие	Takım Ölçüleri (mm) Dimension (mm) Размеры (мм)					Kesici Uç Insert Пластина	Yedek Parçaları / Spare Parts / Запасные части		
		DC	ZEFP	DCON	LF	APMX		Sıkma Vidası Screw Зажимной винт	Tork Anahtar Torx Key Торх Ключ	Montaj Vidası Mounting Screw Монтажный винт
AFM75-AP16-D063-A22-Z04-H	●	63	4	22	40	6	AP.. 1604..	4015-M4x11	80-T15	2508-M10x30
AFM75-AP16-D080-A27-Z05-H	●	80	5	27	50	6				2510-M12x35
AFM75-AP16-D100-A32-Z06-H	●	100	6	32	50	6				2514-M16x35
AFM75-AP16-D125-B40-Z07	●	125	7	40	63	6				-

ISO Ucuna Uygunudur. / Compatible with ISO Insert. / Под пластину ISO

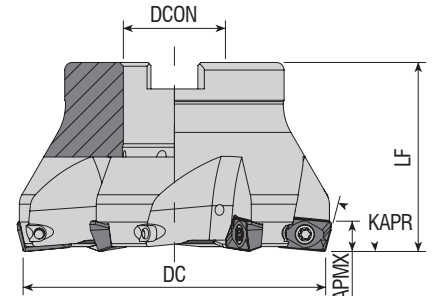

Takım Kodu Ordering Code Код для заказа	Stok Stock Наличие	Takım Ölçüleri (mm) Dimension (mm) Размеры (мм)					Kesici Uç Insert Пластина	Yedek Parçaları / Spare Parts / Запасные части		
		DC	ZEFP	DCON	LF	APMX		Sıkma Vidası Screw Зажимной винт	Tork Anahtar Torx Key Торх Ключ	Montaj Vidası Mounting Screw Монтажный винт
AFM75-X012-D050-A22-Z04-H	●	50	4	22	40	-	XO.. 1204..	3010-M3.5x9	80-T10	2508-M10x30
AFM75-X012-D063-A22-Z05-H	●	63	5	22	40	-				2510-M12x35
AFM75-X012-D080-A27-Z06-H	●	80	6	27	50	-				

R: Sağ / Right / Правый L: Sol / Left / Левый
● Stokta / In Stock / В наличии ○ Stokta Yok / Non Stock Item / Нет в наличии
SC Ucuna Uygunudur. / Compatible with SC Insert. / Под пластину SC

Sipariş Örneği/Ordering Example/ Bestellbeispiel
1 ad./pcs./шт. AFM75-AP16-D063-A22-Z04-H
Kesme Hesabı : S 367 / Cutting Calculation : P 367 / Расчет режимов резания: стр. 367
Montaj Ölçüleri : S 364 / Mounting Reference : P 364 / Инструкция по установке фрез: стр. 364

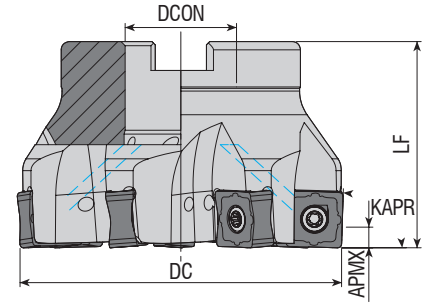

Takım Kodu Ordering Code Код для заказа	Stok Stock Наличие	Takım Ölçüleri (mm) Dimension (mm) Размеры (мм)					Kesici Uç Insert Пластина	Yedek Parçaları / Spare Parts / Запасные части					
		DC	ZEP	DCON	LF	APMX		Sıkma Vidası Screw Зажимной винт	Tork Anahtar Torx Key Торх Ключ	Montaj Vidası Mounting Screw Монтажный винт			
AFM88-SN1305-D050-A22-Z04	●	50	4	22	40	5	SNMU 1305..		4015-M4x11		80-T15		
AFM88-SN1305-D050-A22-Z05	●	50	5	22	40	5							
AFM88-SN1305-D063-A22-Z05	●	63	5	22	40	5							2508-M10x30
AFM88-SN1305-D063-A22-Z07	●	63	7	22	40	5							2510-M12x35
AFM88-SN1305-D080-A27-Z06	●	80	6	27	50	5							2514-M16x35
AFM88-SN1305-D080-A27-Z09	●	80	9	27	50	5							-
AFM88-SN1305-D100-A32-Z07	●	100	7	32	50	5							-
AFM88-SN1305-D100-A32-Z11	●	100	11	32	50	5							-
AFM88-SN1305-D125-B40-Z13	●	125	13	40	63	5							-

KYCR Ucuna Uygun. / Compatible with KYCR Insert. / Под пластину KYCR

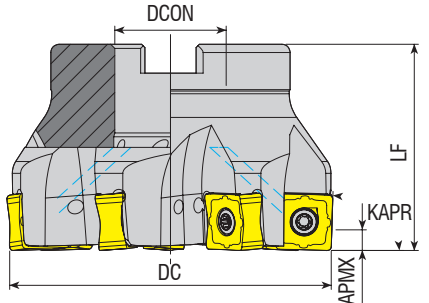

Takım Kodu Ordering Code Код для заказа	Stok Stock Наличие	Takım Ölçüleri (mm) Dimension (mm) Размеры (мм)					Kesici Uç Insert Пластина	Yedek Parçaları / Spare Parts / Запасные части					
		DC	ZEP	DCON	LF	APMX		Sıkma Vidası Screw Зажимной винт	Tork Anahtar Torx Key Торх Ключ	Montaj Vidası Mounting Screw Монтажный винт			
AFM88-SN1306-D050-A22-Z05-H	●	50	5	22	40	5	SNGX 1306..		1115-M4x10		80-T15		
AFM88-SN1306-D063-A22-Z06-H	●	63	6	22	40	5							
AFM88-SN1306-D080-A27-Z07-H	●	80	7	27	50	5							2508-M10x30
													2510-M12x35

R: Sağ / Right / Правый L: Sol / Left / Левый
● Stokta / In Stock / В наличии ○ Stokta Yok / Non Stock Item / Нет в наличии
TGTC Ucuna Uygun. / Compatible with TGTC Insert. / Под пластину TGTC

Sipariş Örneği/Ordering Example/Bestellbeispiel
1 ad./pcs./шт. AFM88-SN1305-D050-A22-Z04

Kesme Hesabı : S 367 / Cutting Calculation : P 367 / Расчет режимов резания: стр. 367
Montaj Ölçüleri : S 364 / Mounting Reference : P 364 / Инструкция по установке фрез: стр. 364

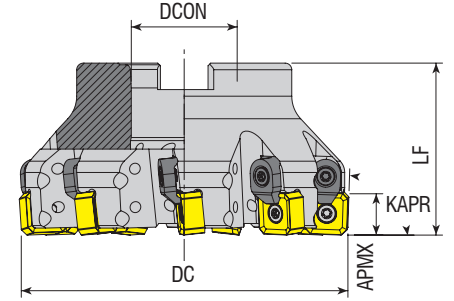

Takım Kodu Ordering Code Код для заказа	Stok Stock Наличие	Takım Ölçüleri (mm) Dimension (mm) Размеры (мм)					Kesici Uç Insert Пластина	Yedek Parçaları / Spare Parts / Запасные части				
		DC	ZEFP	DCON	LF	APMX		Sıkma Vidası Screw Зажимной винт	Baskı Parçası Wedge Clamp Прижим	Baskı Vidası Clamp Screw Зажимной винт	Tork Anahtar Torx Key Торх Ключ	Montaj Vidası Mounting Screw Монтажный винт
AFM88C-SN1206-D050-A22-Z05-H	●	50	5	22	40	11.5	SN.. 1206..	4615-M4x11	ACK-05	4015-M4x11	80-T15	2508-M10x30
AFM88C-SN1206-D063-A22-Z06-H	●	63	6	22	40	11.5						
AFM88C-SN1206-D080-A27-Z07-H	●	80	7	27	50	11.5						
AFM88C-SN1206-D100-A32-Z09-H	●	100	9	32	52	11.5						

ISO Ucuna Uygundur. / Compatible with ISO Insert. / Под пластину ISO

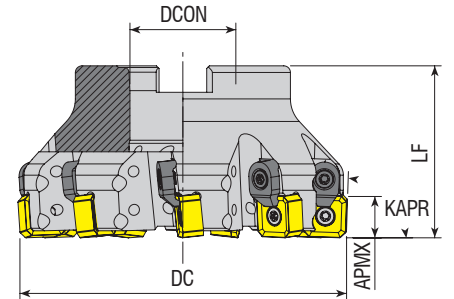

Takım Kodu Ordering Code Код для заказа	Stok Stock Наличие	Takım Ölçüleri (mm) Dimension (mm) Размеры (мм)					Kesici Uç Insert Пластина	Yedek Parçaları / Spare Parts / Запасные части				
		DC	ZEFP	DCON	LF	APMX		Sıkma Vidası Screw Зажимной винт	Baskı Parçası Wedge Clamp Прижим	Baskı Vidası Clamp Screw Зажимной винт	Tork Anahtar Torx Key Торх Ключ	Montaj Vidası Mounting Screw Монтажный винт
AFM88C-SN12..-D050-A22-Z05-H	●	50	5	22	40	11.5	SN.. 12..	1015-M4x11	ACK-05	4015-M4x11	80-T15	2508-M10x30
AFM88C-SN12..-D063-A22-Z06-H	●	63	6	22	40	11.5						
AFM88C-SN12..-D080-A27-Z07-H	●	80	7	27	50	11.5						
AFM88C-SN12..-D100-A32-Z09-H	●	100	9	32	52	11.5						

R: Sağ / Right / Правый L: Sol / Left / Левый

● Stokta / In Stock / В наличии ○ Stokta Yok / Non Stock Item / Нет в наличии

ISO Ucuna Uygundur. / Compatible with ISO Insert. / Под пластину ISO

Sipariş Örneği/Ordering Example/Bestellbeispiel

1 ad./pcs./шт. AFM88C-SN1206-D063-A22-Z06-H

Kesme Hesabı : S 367 / Cutting Calculation : P 367 / Расчет режимов резания: стр. 367

Montaj Ölçüleri : S 364 / Mounting Reference : P 364 / Инструкция по установке фрез: стр. 364

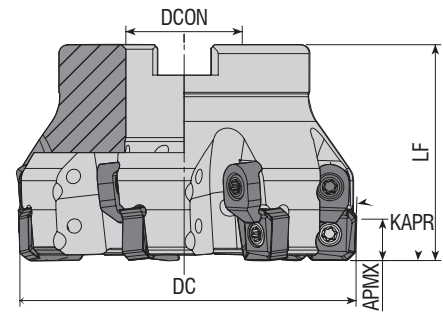

Takım Kodu Ordering Code Код для заказа	Stok Stock Наличие	Takım Ölçüleri (mm) Dimension (mm) Размеры (мм)					Kesici Uç Insert Пластина	Yedek Parçaları / Spare Parts / Запасные части				
		DC	ZEFP	DCON	LF	APMX		Sikma Vidası Screw Зажимной винт	Baskı Parçası Wedge Clamp Прижим	Baskı Vidası Clamp Screw Зажимной винт	Tork Anahtar Torx Key Торкс Ключ	Montaj Vidası Mounting Screw Монтажный винт
AFM88C-SN12Z-D063-A22-Z06-H	●	63	6	22	40	11.5	SNEG 1205..	4015-M4x11	ACK-05	4015-M4X11	80-T15	2508-M10x30
AFM88C-SN12Z-D080-A27-Z07-H	●	80	7	27	50	11.5						2510-M12x35

ZCC Ucuna Uygundur. / Compatible with ZCC Insert. / Под пластину HRN

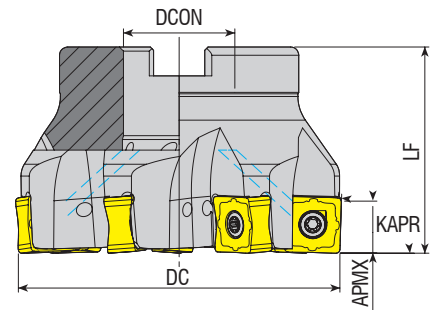

Takım Kodu Ordering Code Код для заказа	Stok Stock Наличие	Takım Ölçüleri (mm) Dimension (mm) Размеры (мм)					Kesici Uç Insert Пластина	Yedek Parçaları / Spare Parts / Запасные части				
		DC	ZEFP	DCON	LF	APMX		Sikma Vidası Screw Зажимной винт	Baskı Parçası Wedge Clamp Прижим	Baskı Vidası Clamp Screw Зажимной винт	Tork Anahtar Torx Key Торкс Ключ	Montaj Vidası Mounting Screw Монтажный винт
AFM89-SN1305I-D040-A16-Z04-H	●	40	4	16	40	10	SNMU 1305..	1015 M4x11	-	-	80-T15	2306-M8x37
AFM89-SN1305I-D050-A22-Z05-H	●	50	5	22	40	10						2508-M10x30
AFM89-SN1305I-D063-A22-Z06-H	●	63	6	22	40	10	SNMU 1305.. OXMT 0507..	-	-	80-T15	2510-M12x35	
AFM89-SN1305I-D063-A22-Z07-H	●	63	7	22	40	10					2514-M16x35	
AFM89-SN1305I-D080-A27-Z08-H	●	80	8	27	50	10						
AFM89-SN1305I-D100-A32-Z10-H	●	100	10	32	50	10						

R: Sağ / Right / Правый L: Sol / Left / Левый

● Stokta / In Stock / В наличии ○ Stokta Yok / Non Stock Item / Нет в наличии

ISCR Ucuna Uygundur. / Compatible with ISCR Insert. / Под пластину ISCR

Sipariş Örneği/Ordering Example/Bestellbeispiel

1 ad./pcs./шт. AFM88C-SN12Z-D063-A22-Z06-H

Kesme Hesabı : S 367 / Cutting Calculation : P 367 / Расчет режимов резания: стр. 367

Montaj Ölçüleri : S 364 / Mounting Reference : P 364 / Инструкция по установке фрез: стр. 364

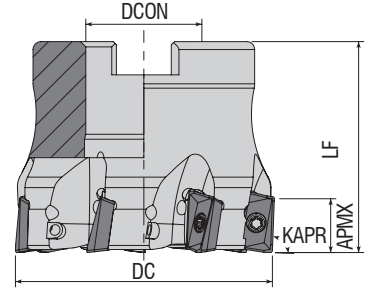

Takım Kodu Ordering Code Код для заказа	Stok Stock Наличие	Takım Ölçüleri (mm) Dimension (mm) Размеры (мм)					Kesici Uç Insert Пластина	Yedek Parçaları / Spare Parts / Запасные части		
		DC	ZEFP	DCON	LF	APMX		Sıkma Vidası Screw Зажимной винт	Tork Anahtar Torx Key Торк Ключ	Montaj Vidası Mounting Screw Монтажный винт
AFM90-AD10T3-D040-A16-Z06-H	●	40	6	16	40	10	ADMT 10T3..	3008-M2.5x6	80-T08	2506-M8x30
AFM90-AD10T3-D050-A22-Z07-H	●	50	7	22	40	10				2508-M10x30

WLTR Ucuna Uygunur. / Compatiple with WLTR Insert. / Под пластину WLTR

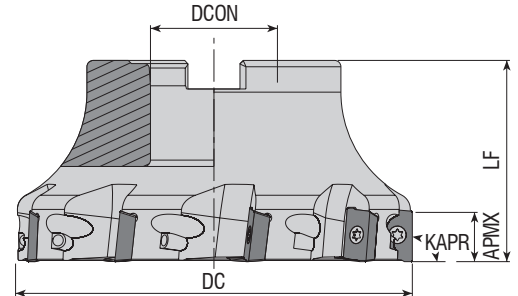

Takım Kodu Ordering Code Код для заказа	Stok Stock Наличие	Takım Ölçüleri (mm) Dimension (mm) Размеры (мм)					Kesici Uç Insert Пластина	Yedek Parçaları / Spare Parts / Запасные части		
		DC	ZEFP	DCON	LF	APMX		Sıkma Vidası Screw Зажимной винт	Tork Anahtar Torx Key Торк Ключ	Montaj Vidası Mounting Screw Монтажный винт
AFM90-AD1505-D040-A16-Z04-H	●	40	4	16	40	14.3	AD.. 1505..	4015-M4x11	80-T15	2506-M8x30
AFM90-AD1505-D050-A22-Z05-H	●	50	5	22	40	14.3				2508-M10x30
AFM90-AD1505-D063-A22-Z06-H	●	63	6	22	40	14.3				2510-M12x35
AFM90-AD1505-D080-A27-Z07-H	●	80	7	27	50	14.3				2514-M16x35
AFM90-AD1505-D100-A32-Z08-H	●	100	8	32	50	14.3				-
AFM90-AD1505-D125-B40-Z09	●	125	9	40	63	14.3				-

R: Sağ / Right / Правый L: Sol / Left / Левый
● Stokta / In Stock / В наличии ○ Stokta Yok / Non Stock Item / Нет в наличии
ISCR Ucuna Uygunur. / Compatiple with ISCR Insert. / Под пластину ISCR

Sipariş Örneği/Ordering Example/Bestellbeispiel
1 ad./pcs./шт. AFM90-AD10T3-D040-A16-Z06-H
Kesme Hesabı : S 367 / Cutting Calculation : P 367 / Расчет режимов резания: стр. 367
Montaj Ölçüleri : S 364 / Mounting Reference : P 364 / Инструкция по установке фрез: стр. 364

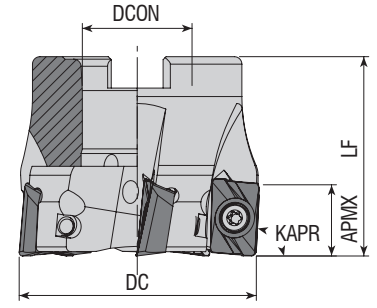

Takım Kodu Ordering Code Код для заказа	Stok Stock Наличие	Takım Ölçüleri (mm) Dimension (mm) Размеры (мм)					Kesici Uç Insert Пластина	Yedek Parçaları / Spare Parts / Запасные части		
		DC	ZEFP	DCON	LF	APMX		Sıkma Vidası Screw Зажимной винт	Tork Anahtar Torx Key Торх Ключ	Montaj Vidası Mounting Screw Монтажный винт
AFM90-AD1505D-D050-A22-Z05-H	●	50	5	22	40	14.3	ADKT 150508	4015-M4x11	80-T15	2508-M10x30
AFM90-AD1505D-D063-A27-Z06-H	●	63	6	27	50	14.3				2510-M12x35
AFM90-AD1505D-D080-A27-Z08-H	●	80	8	27	50	14.3				2514-M16x35
AFM90-AD1505D-D100-A32-Z08-H	●	100	8	32	50	14.3				-
AFM90-AD1505D-D125-B40-Z09	●	125	9	40	63	14.3				-

DJT Ucuna Uygunudur. / Compatible with DJT Insert. / Под пластину DJT

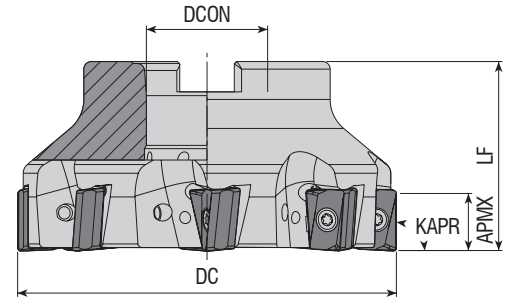

Takım Kodu Ordering Code Код для заказа	Stok Stock Наличие	Takım Ölçüleri (mm) Dimension (mm) Размеры (мм)					Kesici Uç Insert Пластина	Yedek Parçaları / Spare Parts / Запасные части					
		DC	ZEFP	DCON	LF	APMX		Sıkma Vidası Screw Зажимной винт	Tork Anahtar Torx Key Торх Ключ	Montaj Vidası Mounting Screw Монтажный винт			
AFM90-AN11-D040-A16-Z04-H	●	40	4	16	40	11	ANGX 1105..	4010-M3x8	80-T10	2506-M8x30			
AFM90-AN1506-D050-A22-Z04-H	●	50	4	22	40	14.5				2508-M10x30			
AFM90-AN1506-D063-A22-Z05-H	●	63	5	22	40	14.5				ANGX 1506..	4015-M4x12	80-T15	2510-M12x35
AFM90-AN1506-D080-A27-Z06-H	●	80	6	27	50	14.5							2514-M16x35
AFM90-AN1506-D100-A32-Z08-H	●	100	8	32	50	14.5							-
AFM90-AN1506-D125-B40-Z09	●	125	9	40	63	14.5							-
AFM90-AN1506-D160-C40-Z10	●	160	10	40	63	14.5							-

R: Sağ / Right / Правый L: Sol / Left / Левый
● Stokta / In Stock / В наличии ○ Stokta Yok / Non Stock Item / Нет в наличии
ZCC Ucuna Uygunudur. / Compatible with ZCC Insert. / Под пластину HRN

Sipariş Örneği/Ordering Example/Bestellbeispiel
1 ad./pcs./шт. AFM90-AD1505D-D050-A22-Z05-H
Kesme Hesabı : S 367 / Cutting Calculation : P 367 / Расчет режимов резания: стр. 367
Montaj Ölçüleri : S 364 / Mounting Reference : P 364 / Инструкция по установке фрез: стр. 364

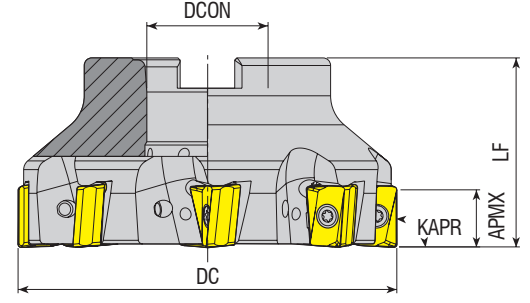

Takım Kodu Ordering Code Код для заказа	Stok Stock Наличие	Takım Ölçüleri (mm) Dimension (mm) Размеры (мм)					Kesici Uç Insert Пластина	Yedek Parçaları / Spare Parts / Запасные части			
		DC	ZEPF	DCON	LF	APMX		Sıkma Vidası Screw Зажимной винт	Tork Anahtar Torx Key Торх Ключ	Montaj Vidası Mounting Screw Монтажный винт	
AFM90-AN1607-D050-A22-Z04-H	●	50	4	22	40	15	AN.X 1607..				
AFM90-AN1607-D063-A22-Z06-H	●	63	6	22	40	15					2508-M10x30
AFM90-AN1607-D080-A27-Z07-H	●	80	7	27	50	15					2510-M12x35
AFM90-AN1607-D100-A32-Z08-H	●	100	8	32	50	15					2514-M16x35
AFM90-AN1607-D125-B40-Z10	●	125	10	40	63	15					-

TGTC Ucuna Uygundur. / Compatiple with TGTC Insert. / Под пластину TGTC

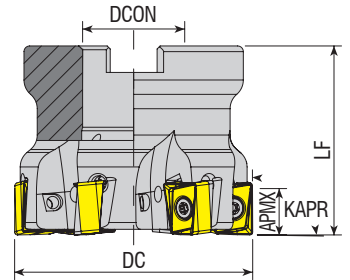

Takım Kodu Ordering Code Код для заказа	Stok Stock Наличие	Takım Ölçüleri (mm) Dimension (mm) Размеры (мм)					Kesici Uç Insert Пластина	Yedek Parçaları / Spare Parts / Запасные части			
		DC	ZEPF	DCON	LF	APMX		Sıkma Vidası Screw Зажимной винт	Tork Anahtar Torx Key Торх Ключ	Montaj Vidası Mounting Screw Монтажный винт	
AFM90-AN12-D040-A16-Z04-H	●	40	4	16	40	12	ANKX 1205..				
AFM90-AN12-D050-A22-Z05-H	●	50	5	22	40	12					2406-M8x30
AFM90-AN12-D063-A27-Z06-H	●	63	6	27	50	12					2508-M10x30 2510-M12x35

R: Sağ / Right / Правый L: Sol / Left / Левый

● Stokta / In Stock / В наличии ○ Stokta Yok / Non Stock Item / Нет в наличии
ISCR Ucuna Uygundur. / Compatiple with ISCR Insert. / Под пластину ISCR

Sipariş Örneği/Ordering Example/Bestellbeispiel

1 ad./pcs./шт. AFM90-AN1607-D050-A22-Z04-H

Kesme Hesabı : S 367 / Cutting Calculation : P 367 / Расчет режимов резания: стр. 367

Montaj Ölçüleri : S 364 / Mounting Reference : P 364 / Инструкция по установке фрез: стр. 364

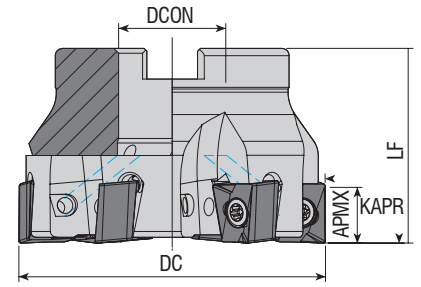

Takım Kodu Ordering Code Код для заказа	Stok Stock Наличие	Takım Ölçüleri (mm) Dimension (mm) Размеры (мм)					Kesici Uç Insert Пластина	Yedek Parçaları / Spare Parts / Запасные части				
		DC	ZEFP	DCON	LF	APMX		Sıkma Vidası Screw Зажимной винт	Tork Anahtar Torx Key Торх Ключ	Montaj Vidası Mounting Screw Монтажный винт		
AFM90-AN1207-D040-A16-Z04-H	●	40	4	16	40	10				2506-M8x30		
AFM90-AN1207-D050-A22-Z05-H	●	50	5	22	40	10				4015-M4x11	80-T15	2508-M10x30
AFM90-AN1207-D063-A22-Z06-H	●	63	6	22	40	10						2508-M10x30
AFM90-AN1607X-D050-A22-Z04-H	●	50	4	22	40	15		4015-M4x11	80-T15	2510-M12x35		
AFM90-AN1607X-D063-A22-Z06-H	●	63	6	22	40	15						
AFM90-AN1607X-D080-A27-Z07-H	●	80	7	27	50	15						

XTC-GSC Ucuna Uygunudur. / Compatible with XTC-GSC Insert. / Под пластину XTC-GSC

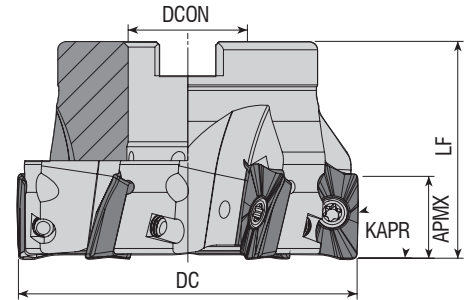

Takım Kodu Ordering Code Код для заказа	Stok Stock Наличие	Takım Ölçüleri (mm) Dimension (mm) Размеры (мм)					Kesici Uç Insert Пластина	Yedek Parçaları / Spare Parts / Запасные части				
		DC	ZEFP	DCON	LF	APMX		Sıkma Vidası Screw Зажимной винт	Tork Anahtar Torx Key Торх Ключ	Montaj Vidası Mounting Screw Монтажный винт		
AFM90-A01236-D050-A22-Z05-H	●	50	5	22	40	10				2508-M10x30		
AFM90-A01848-D050-A22-Z05-H	●	50	5	22	40	15					4015-M4x11	80-T15
AFM90-A01848-D063-A22-Z06-H	●	63	6	22	40	15						

R: Sağ / Right / Правый L: Sol / Left / Левый
● Stokta / In Stock / В наличии ○ Stokta Yok / Non Stock Item / Нет в наличии
MTSBH Ucuna Uygunudur. / Compatible with MTSBH Insert. / Под пластину MTSBH

Sipariş Örneği/Ordering Example/Bestellbeispiel
1 ad./pcs./шт. AFM90-AN1207-D040-A16-Z04-H
Kesme Hesabı : S 367 / Cutting Calculation : P 367 / Расчет режимов резания: стр. 367
Montaj Ölçüleri : S 364 / Mounting Reference : P 364 / Инструкция по установке фрез: стр. 364

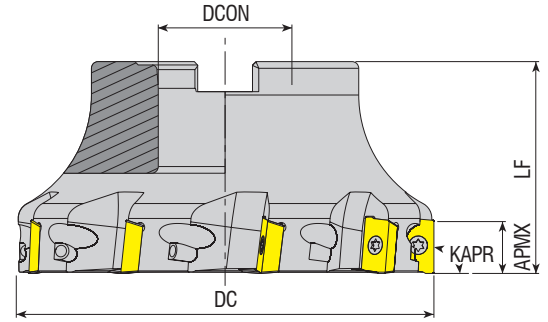

Yedek Parçaları / Spare Parts / Запасные части

Takım Kodu Ordering Code Код для заказа	Stok Stock Наличие	Takım Ölçüleri (mm) Dimension (mm) Размеры (мм)					Kesici Uç Insert Пластина	Yedek Parçaları / Spare Parts / Запасные части		
		DC	ZEFP	DCON	LF	APMX		Sıkma Vidası Screw Зажимной винт	Tork Anahtar Torx Key Торх Ключ	Montaj Vidası Mounting Screw Монтажный винт
AFM90-AP10-D040-A16-Z05-H	●	40	5	16	40	10	AP. 1003.. ISO UCUNA UYGUNDUR. FOR ISO INSERT. Под пластину ISO	3008-M2.5x6	80-T08	2506-M8x30
AFM90-AP10-D050-A22-Z06-H	●	50	6	22	40	10				2508-M10x30
AFM90-AP10-D063-A22-Z07-H	●	63	7	22	40	10				2510-M12x35
AFM90-AP10-D080-A27-Z08-H	●	80	8	27	50	10	AP. 1604.. ISO UCUNA UYGUNDUR. FOR ISO INSERT. Под пластину ISO	4015-M4x11	80-T15	2514-M16x35
AFM90-AP10-D100-A32-Z09-H	●	100	9	32	50	10				2506-M8x30
AFM90-AP16-D040-A16-Z04-H	●	40	4	16	40	16				2508-M10x30
AFM90-AP16-D050-A22-Z05-H	●	50	5	22	40	16	AP. 1604.. DJT UCUNA UYGUNDUR. FOR DJT INSERT. Под пластину DJT	80-T15	80-T15	2510-M12x35
AFM90-AP16-D052-A22-Z05-H	●	52	5	22	40	16				2506-M8x30
AFM90-AP16-D063-A22-Z06-H	●	63	6	22	40	16				2508-M10x30
AFM90-AP16-D080-A27-Z07-H	●	80	7	27	50	16	AP. 1604.. LMN UCUNA UYGUNDUR. FOR LMN INSERT. Под пластину LMN	4015-M4x11	80-T15	2514-M16x35
AFM90-AP16-D100-A32-Z08-H	●	100	8	32	50	16				-
AFM90-AP16-D125-B40-Z09	●	125	9	40	63	16				2508-M10x30
AFM90-AP16-D160-C40-Z10	●	160	10	40	63	16	AP. 1604.. PLBT UCUNA UYGUNDUR. FOR PLBT INSERT. Под пластину PLBT	4015-M4x11	80-T15	2510-M12x35
AFM90-AP16-D200-C60-Z12	●	200	12	60	63	16				2506-M8x30
AFM90-AP16DJ-D050-A22-Z05-H	●	50	5	22	40	16				2508-M10x30
AFM90-AP16DJ-D063-A22-Z06-H	●	63	6	22	40	16	AP. 1604.. ACHTK UCUNA UYGUNDUR. FOR ACHTK INSERT. Под пластину ACHTK	80-T15	80-T15	2510-M12x35
AFM90-AP16DJ-D080-A27-Z07-H	●	80	7	27	50	16				2508-M10x30
AFM90-AP16L-D050-A22-Z05-H	●	50	5	22	40	16				2514-M16x35
AFM90-AP16L-D063-A22-Z06-H	●	63	6	22	40	16	AP. 1604.. YG UCUNA UYGUNDUR. FOR YG INSERT. Под пластину YG	4015-M4x11	80-T15	2508-M10x30
AFM90-AP16L-D080-A27-Z07-H	●	80	7	27	50	16				2510-M12x35
AFM90-AP16P-D040-A16-Z04-H	●	40	4	16	40	16				2506-M8x30
AFM90-AP16P-D050-A22-Z05-H	●	50	5	22	40	16	AP. 1604.. ACHTK UCUNA UYGUNDUR. FOR ACHTK INSERT. Под пластину ACHTK	4015-M4x11	80-T15	2508-M10x30
AFM90-AP16P-D063-A22-Z06-H	●	63	6	22	40	16				2510-M12x35
AFM90-AP16P-D080-A27-Z07-H	●	80	7	27	50	16				2514-M16x35
AFM90-AP16P-D100-A32-Z08-H	●	100	8	32	50	16	AP. 1604.. ACHTK UCUNA UYGUNDUR. FOR ACHTK INSERT. Под пластину ACHTK	4015-M4x11	80-T15	2508-M10x30
AFM90-AP16A-D050-A22-Z05-H	●	50	5	22	40	15				2510-M12x35
AFM90-AP16A-D063-A22-Z06-H	●	63	6	22	40	15				2514-M16x35
AFM90-AP16A-D080-A27-Z07-H	●	80	7	27	50	15	AP. 1604.. YG UCUNA UYGUNDUR. FOR YG INSERT. Под пластину YG	4015-M4x11	80-T15	-
AFM90-AP16A-D100-A32-Z08-H	●	100	8	32	50	15				2506-M8x30
AFM90-AP16A-D125-B40-Z09	●	125	9	40	63	15				2508-M10x30
AFM90-AP16Y-D040-A16-Z04-H	●	40	4	16	40	16	AP. 1604.. YG UCUNA UYGUNDUR. FOR YG INSERT. Под пластину YG	4015-M4x11	80-T15	2510-M12x35
AFM90-AP16Y-D050-A22-Z05-H	●	50	5	22	40	16				2506-M8x30
AFM90-AP16Y-D063-A22-Z06-H	●	63	6	22	40	16				2508-M10x30
AFM90-AP16Y-D080-A27-Z07-H	●	80	7	27	50	16	AP. 1604.. YG UCUNA UYGUNDUR. FOR YG INSERT. Под пластину YG	4015-M4x11	80-T15	2514-M16x35
AFM90-AP16Y-D100-A32-Z08-H	●	100	8	32	50	16				2506-M8x30

R: Sağ / Right / Правый L: Sol / Left / Левый

● Stokta / In Stock / В наличии ○ Stokta Yok / Non Stock Item / Нет в наличии

Sipariş Örneği/Ordering Example/Bestellbeispiel

1 ad./pcs./шт. AFM90-AP10-D040-A16-Z05-H

Kesme Hesabı : S 367 / Cutting Calculation : P 367 / Расчет режимов резания: стр. 367

Montaj Ölçüleri : S 364 / Mounting Reference : P 364 / Инструкция по установке фрез: стр. 364

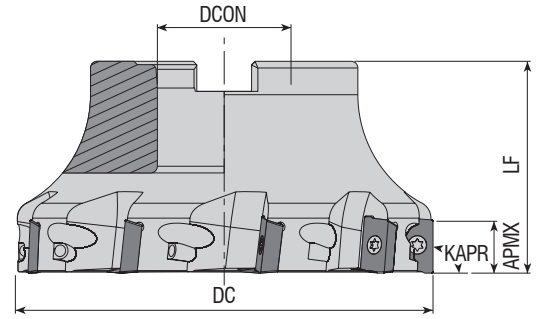
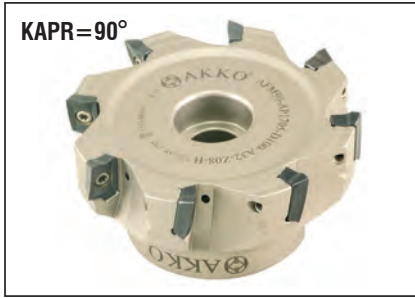

Takım Kodu Ordering Code Код для заказа	Stok Stock Наличие	Takım Ölçüleri (mm) Dimension (mm) Размеры (мм)					Kesici Uç Insert Пластина	Yedek Parçaları / Spare Parts / Запасные части		
		DC	ZEFP	DCON	LF	APMX		Sikma Vidası Screw Зажимной винт	Tork Anahtar Torx Key Торх Ключ	Montaj Vidası Mounting Screw Монтажный винт
AFM90-AP1705-D050-A22-Z05-H	●	50	5	22	40	16	AP. 1705..	4015-M4x11	80-T15	2508-M10x30 2510-M12x35 2514-M16x35
AFM90-AP1705-D063-A22-Z06-H	●	63	6	22	40	16				
AFM90-AP1705-D080-A27-Z07-H	●	80	7	27	50	16				
AFM90-AP1705-D100-A32-Z08-H	●	100	8	32	50	16				

TGTC Ucuna Uygun. / Compatible with TGTC Insert. / Под пластину TGTC

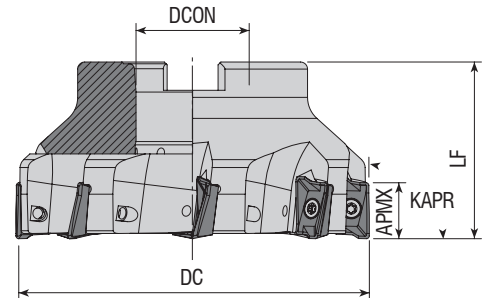

Takım Kodu Ordering Code Код для заказа	Stok Stock Наличие	Takım Ölçüleri (mm) Dimension (mm) Размеры (мм)					Kesici Uç Insert Пластина	Yedek Parçaları / Spare Parts / Запасные части		
		DC	ZEFP	DCON	LF	APMX		Sikma Vidası Screw Зажимной винт	Tork Anahtar Torx Key Торх Ключ	Montaj Vidası Mounting Screw Монтажный винт
AFM90-AX1235-D040-A16-Z06-H	●	40	6	16	40	10	AX.T 1235..	3108-M3x6	80-T08	2506-M8x30 2508-M10x30 2510-M12x35
AFM90-AX1235-D050-A22-Z07-H	●	50	7	22	40	10				
AFM90-AX1235-D063-A22-Z08-H	●	63	8	22	40	10				
AFM90-AX1235-D080-A27-Z10-H	●	80	10	27	50	10				
AFM90-AX1705-D040-A16-Z04-H	●	40	4	16	40	14	AX.T 1705..	4015-M4x11	80-T15	2506-M8x30 2508-M10x30 2510-M12x35 2514-M16x35
AFM90-AX1705-D050-A22-Z05-H	●	50	5	22	40	14				
AFM90-AX1705-D063-A22-Z06-H	●	63	6	22	40	14				
AFM90-AX1705-D080-A27-Z07-H	●	80	7	27	50	14				
AFM90-AX1705-D100-A32-Z08-H	●	100	8	32	50	14				

R: Sağ / Right / Правый L: Sol / Left / Левый

● Stokta / In Stock / В наличии ○ Stokta Yok / Non Stock Item / Нет в наличии

SMTM Ucuna Uygun. / Compatible with SMTM Insert. / Под пластину SMTM

Sipariş Örneği/Ordering Example/Bestellbeispiel
1 ad./pcs./шт. AFM90-AP1705-D050-A22-Z05-H

Kesme Hesabı : S 367 / Cutting Calculation : P 367 / Расчет режимов резания: стр. 367
Montaj Ölçüleri : S 364 / Mounting Reference : P 364 / Инструкция по установке фрез: стр. 364

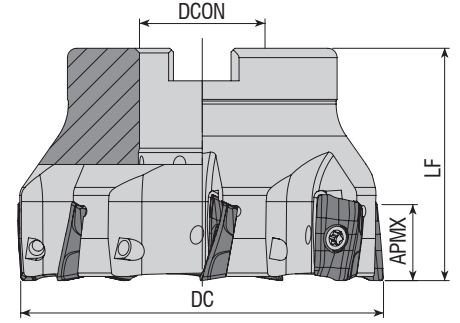

Takım Kodu Ordering Code Код для заказа	Stok Stock Наличие	Takım Ölçüleri (mm) Dimension (mm) Размеры (мм)					Kesici Uç Insert Пластина	Yedek Parçaları / Spare Parts / Запасные части		
		DC	ZEFP	DCON	LF	APMX		Sıkma Vidası Screw Зажимной винт	Tork Anahtar Torx Key Торх Ключ	Montaj Vidası Mounting Screw Монтажный винт
AFM90-BD11T3-D040-A16-Z04-H	●	40	4	16	40	10	BDMT 11T3..	3008-M2.5x6	80-T08	2506-M8x30
AFM90-BD11T3-D040-A16-Z05-H	●	40	5	16	40	10				
AFM90-BD11T3-D050-A22-Z05-H	●	50	5	22	40	10				
AFM90-BD11T3-D063-A22-Z06-H	●	63	6	22	40	10				
AFM90-BD1704-D050-A22-Z04-H	●	50	4	22	40	15.7	BDMT 1704..	4015-M4x11	80-T15	2508-M10x30
AFM90-BD1704-D050-A22-Z05-H	●	50	5	22	40	15.7				
AFM90-BD1704-D063-A22-Z06-H	●	63	6	22	40	15.7				
AFM90-BD1704-D080-A27-Z06-H	●	80	6	27	50	15.7				
AFM90-BD1704-D080-A27-Z07-H	●	80	7	27	50	15.7				
AFM90-BD1704-D100-A32-Z07-H	●	100	7	32	50	15.7				

KYCR Ucuna Uygunudur. / Compatible with KYCR Insert. / Под пластину KYCR

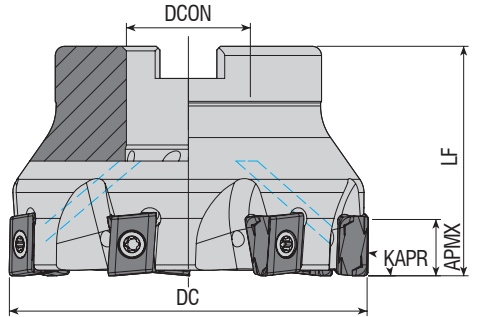

Takım Kodu Ordering Code Код для заказа	Stok Stock Наличие	Takım Ölçüleri (mm) Dimension (mm) Размеры (мм)					Kesici Uç Insert Пластина	Yedek Parçaları / Spare Parts / Запасные части		
		DC	ZEFP	DCON	LF	APMX		Sıkma Vidası Screw Зажимной винт	Tork Anahtar Torx Key Торх Ключ	Montaj Vidası Mounting Screw Монтажный винт
AFM90-LN1506X-D063-A22-Z06	●	63	6	22	40	7	LNMT 1506..	3015-M4x11	80-T15	2508-M10x30
AFM90-LN1506X-D080-A27-Z07	●	80	7	27	50	7				2510-M12x35
AFM90-LN1506X-D100-A32-Z08	●	100	8	32	50	7				2514-M16x35

R: Sağ / Right / Правый L: Sol / Left / Левый

● Stokta / In Stock / В наличии ○ Stokta Yok / Non Stock Item / Нет в наличии

XTC-GSC Ucuna Uygunudur. / Compatible with XTC-GSC Insert. / Под пластину XTC-GSC

Sipariş Örneği/Ordering Example/Bestellbeispiel

1 ad./pcs./шт. AFM90-BD11T3-D040-A16-Z04-H

Kesme Hesabı : S 367 / Cutting Calculation : P 367 / Расчет режимов резания: стр. 367

Montaj Ölçüleri : S 364 / Mounting Reference : P 364 / Инструкция по установке фрез: стр. 364

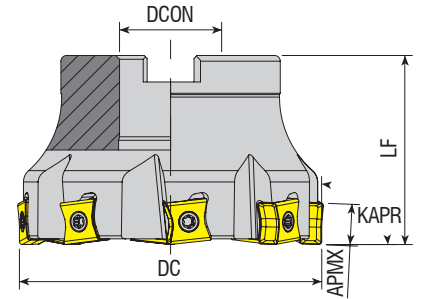

Takım Kodu Ordering Code Код для заказа	Stok Stock Наличие	Takım Ölçüleri (mm) Dimension (mm) Размеры (мм)					Kesici Uç Insert Пластина	Yedek Parçaları / Spare Parts / Запасные части		
		DC	ZEFP	DCON	LF	APMX		Sikma Vidası Screw Зажимной винт	Tork Anahtar Torx Key Торх Ключ	Montaj Vidası Mounting Screw Монтажный винт
AFM90-LN1106-D050-A22-Z05	●	50	5	22	40	10	LNMT 1106..	4015-M3.5x11	80-T15	2508-M10x30
AFM90-LN1106-D063-A22-Z06	●	63	6	22	40	10				2510-M12x35
AFM90-LN1106-D080-A27-Z08	●	80	8	27	50	10				2514-M16x35
AFM90L-LN1106-D080-A27-Z08	●	80	8	27	50	10				-
AFM90-LN1106-D100-A32-Z09	●	100	9	32	50	10				2506-M8x30
AFM90L-LN1106-D100-A32-Z09	●	100	9	32	50	10				2508-M10x30
AFM90-LN1106-D125-B40-Z10	●	125	10	40	63	10	T490 LNMT 1306..	4015-M4x11	80-T15	2510-M12x35
AFM90-LN1306-D040-A16-Z04-H	●	40	4	16	40	12.5				2514-M16x35
AFM90-LN1306-D050-A22-Z05-H	●	50	5	22	40	12.5				2506-M8x30
AFM90-LN1306-D063-A22-Z06-H	●	63	6	22	40	12.5				2508-M10x30
AFM90-LN1306-D080-A27-Z07-H	●	80	7	27	50	12.5	LNMT 1506..	4015-M4x11	80-T15	2510-M12x35
AFM90-LN1306-D100-A32-Z08-H	●	100	8	32	50	12.5				2514-M16x35
AFM90L-LN1506-D040-A16-Z04	●	40	4	16	40	14				2506-M8x30
AFM90-LN1506-D040-A16-Z04	○	40	4	16	40	14				2508-M10x30
AFM90-LN1506-D050-A22-Z05	○	50	5	22	40	14	T490 LNHT 1607..	4420-M5x14	80-T20	2510-M12x35
AFM90-LN1506-D063-A22-Z06	○	63	6	22	40	14				2508-M10x30
AFM90-LN1506-D080-A27-Z07	○	80	7	27	50	14				2510-M12x35
AFM90-LN1607-D050-A22-Z03-H	●	50	3	22	40	16				2514-M16x35
AFM90-LN1607-D063-A22-Z04-H	○	63	4	22	40	16	T490 LNHT 1607..	4420-M5x14	80-T20	2508-M10x30
AFM90-LN1607-D080-A27-Z05-H	●	80	5	27	50	16				2510-M12x35
AFM90-LN1607-D100-A32-Z06-H	●	100	6	32	50	16				2514-M16x35

R: Sağ / Right / Правый L: Sol / Left / Левый

● Stokta / In Stock / В наличии ○ Stokta Yok / Non Stock Item / Нет в наличии
ISCR Ucuna Uygunudur. / Compatible with ISCR Insert. / Под пластину ISCR

Sipariş Örneği/Ordering Example/Bestellbeispiel
1 ad./pcs./шт. AFM90-LN1106-D050-A22-Z05

Kesme Hesabı : S 367 / Cutting Calculation : P 367 / Расчет режимов резания: стр. 367
Montaj Ölçüleri : S 364 / Mounting Reference : P 364 / Инструкция по установке фрез: стр. 364

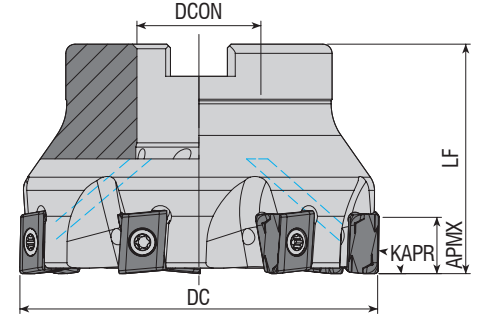

Takım Kodu Ordering Code Код для заказа	Stok Stock Наличие	Takım Ölçüleri (mm) Dimension (mm) Размеры (мм)					Kesici Uç Insert Пластина	Yedek Parçaları / Spare Parts / Запасные части		
		DC	ZEFP	DCON	LF	APMX		Sıkma Vidası Screw Зажимной винт	Tork Anahtar Torx Key Торх Ключ	Montaj Vidası Mounting Screw Монтажный винт
AFM90-LN1306W-D050-A22-Z05-H	●	50	5	22	40	12	LNHU 1306..	4115-M4x12	80-T15	2508-M10x30 2510-M12x35
AFM90-LN1306W-D063-A22-Z06-H	●	63	6	22	40	12				
AFM90-LN1306W-D080-A27-Z07-H	●	80	7	27	50	12				

WLTR Ucuna Uygunur. / Compatiple with WLTR Insert. / Под пластину WLTR

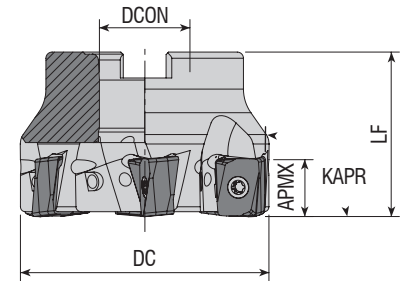

Takım Kodu Ordering Code Код для заказа	Stok Stock Наличие	Takım Ölçüleri (mm) Dimension (mm) Размеры (мм)					Kesici Uç Insert Пластина	Yedek Parçaları / Spare Parts / Запасные части		
		DC	ZEFP	DCON	LF	APMX		Sıkma Vidası Screw Зажимной винт	Tork Anahtar Torx Key Торх Ключ	Montaj Vidası Mounting Screw Монтажный винт
AFM90-LN1307-D050-A22-Z04-H	●	50	4	22	40	13	LNGX 1307..	1315-M4x11	80-T15	2508-M10x30 2510-M12x35 2514-M16x35
AFM90-LN1307-D063-A22-Z06-H	●	63	6	22	40	13				
AFM90-LN1307-D080-A27-Z07-H	●	80	7	27	50	13				
AFM90-LN1307-D100-A32-Z08-H	●	100	8	32	50	13				

R: Sağ / Right / Правый L: Sol / Left / Левый
● Stokta / In Stock / В наличии ○ Stokta Yok / Non Stock Item / Нет в наличии
WLTR Ucuna Uygunur. / Compatiple with WLTR Insert. / Под пластину WLTR

Sipariş Örneği/Ordering Example/Bestellbeispiel
1 ad./pcs./шт. AFM90-LN1306W-D050-A22-Z05-H

Kesme Hesabı : S 367 / Cutting Calculation : P 367 / Расчет режимов резания: стр. 367
Montaj Ölçüleri : S 364 / Mounting Reference : P 364 / Инструкция по установке фрез: стр. 364

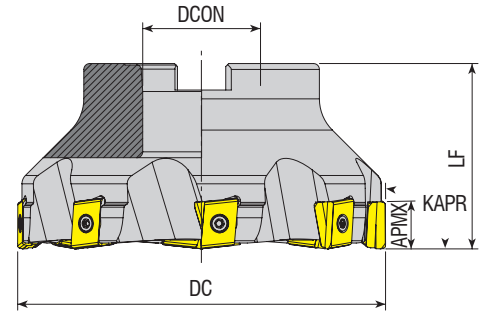

Takım Kodu Ordering Code Код для заказа	Stok Stock Наличие	Takım Ölçüleri (mm) Dimension (mm) Размеры (мм)					Kesici Uç Insert Пластина	Yedek Parçaları / Spare Parts / Запасные части			
		DC	ZEFP	DCON	LF	APMX		Sıkma Vidası Screw Зажимной винт	Tork Anahtar Torx Key Торх Ключ	Montaj Vidası Mounting Screw Монтажный винт	
AFM90-LN15Z-D050-A22-Z04	●	50	4	22	40	15	LNKT 1506..				
AFM90-LN15Z-D063-A22-Z05	●	63	5	22	40	15					2508-M10x30
AFM90-LN15Z-D080-A27-Z06	●	80	6	27	50	15					2510-M12x35
AFM90-LN15Z-D100-A32-Z07	●	100	7	32	50	15					2514-M16x35
AFM90-LN15Z-D125-B40-Z08	●	125	8	40	63	15					-

ZCC Ucuna Uygunudur. / Compatiple with ZCC Insert. / Под пластину HRN

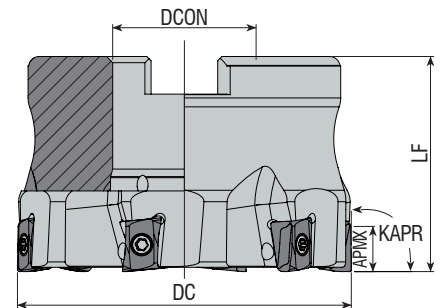

Takım Kodu Ordering Code Код для заказа	Stok Stock Наличие	Takım Ölçüleri (mm) Dimension (mm) Размеры (мм)					Kesici Uç Insert Пластина	Yedek Parçaları / Spare Parts / Запасные части			
		DC	ZEFP	DCON	LF	APMX		Sıkma Vidası Screw Зажимной винт	Tork Anahtar Torx Key Торх Ключ	Montaj Vidası Mounting Screw Монтажный винт	
AFM90-L008-D040-A16-Z06-H	●	40	6	16	40	2	LOEX 0804..				
AFM90-L008-D050-A22-Z07-H	●	50	7	22	40	2					2506-M8x30
AFM90-L008-D063-A27-Z06-H	●	63	6	27	40	2					2508-M10x30 2510-M12x35

R: Sağ / Right / Правый L: Sol / Left / Левый

● Stokta / In Stock / В наличии ○ Stokta Yok / Non Stock Item / Нет в наличии

SC Ucuna Uygunudur. / Compatiple with SC Insert. / Под пластину SC

Sipariş Örneği/Ordering Example/Bestellbeispiel

1 ad./pcs./шт. AFM90-LN15Z-D050-A22-Z04

Kesme Hesabı : S 367 / Cutting Calculation : P 367 / Расчет режимов резания: стр. 367

Montaj Ölçüleri : S 364 / Mounting Reference : P 364 / Инструкция по установке фрез: стр. 364

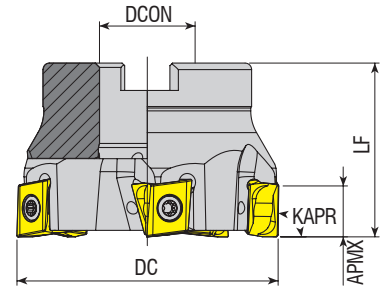

Takım Kodu Ordering Code Код для заказа	Stok Stock Наличие	Takım Ölçüleri (mm) Dimension (mm) Размеры (мм)					Kesici Uç Insert Пластина	Yedek Parçaları / Spare Parts / Запасные части			
		DC	ZEFP	DCON	LF	APMX		Sıkma Vidası Screw Зажимной винт	Tork Anahtar Torx Key Торх Ключ	Montaj Vidası Mounting Screw Монтажный винт	
AFM90-L01207-D040-A16-Z04-H	●	40	4	16	40	11	LOGU 1207..				
AFM90-L01207-D050-A22-Z05-H	●	50	5	22	40	11					2506-M8x30
AFM90-L01207-D063-A22-Z05-H	●	63	5	22	40	11					2508-M10x30

MTSBH Ucuna Uygunudur. / Compatiple with MTSBH Insert. / Под пластину MTSBH.

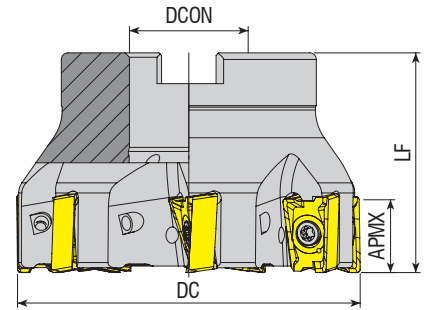

Takım Kodu Ordering Code Код для заказа	Stok Stock Наличие	Takım Ölçüleri (mm) Dimension (mm) Размеры (мм)					Kesici Uç Insert Пластина	Yedek Parçaları / Spare Parts / Запасные части			
		DC	ZEFP	DCON	LF	APMX		Sıkma Vidası Screw Зажимной винт	Tork Anahtar Torx Key Торх Ключ	Montaj Vidası Mounting Screw Монтажный винт	
AFM90-LN15T6-D050-A22-Z05-H	●	50	5	22	40	15.5	LNGU 15T6..				
AFM90-LN15T6-D063-A22-Z06-H	●	63	6	22	40	15.5					2508-M10x30
AFM90-LN15T6-D080-A27-Z07-H	●	80	7	27	50	15.5					2510-M12x35

R: Sağ / Right / Правый L: Sol / Left / Левый
● Stokta / In Stock / В наличии ○ Stokta Yok / Non Stock Item / Нет в наличии
KNMTL Ucuna Uygunudur. / Compatiple with KNMTL Insert. / Под пластину KNMTL

Sipariş Örneği/Ordering Example/Bestellbeispiel
1 ad./pcs./шт. AFM90-L01207-D040-A16-Z04-H
Kesme Hesabı : S 367 / Cutting Calculation : P 367 / Расчет режимов резания: стр. 367
Montaj Ölçüleri : S 364 / Mounting Reference : P 364 / Инструкция по установке фрез: стр. 364

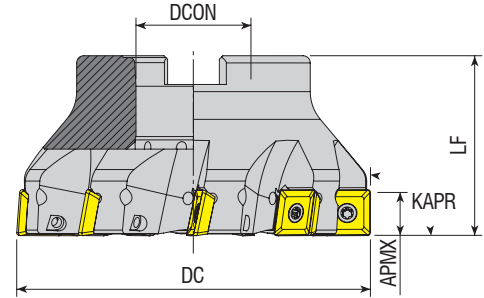

Takım Kodu Ordering Code Код для заказа	Stok Stock Наличие	Takım Ölçüleri (mm) Dimension (mm) Размеры (мм)					Kesici Uç Insert Пластина	Yedek Parçaları / Spare Parts / Запасные части		
		DC	ZEFP	DCON	LF	APMX		Sikma Vidası Screw Зажимной винт	Tork Anahtar Torx Key Торх Ключ	Montaj Vidası Mounting Screw Монтажный винт
AFM90-R290.12-D050-A22-Z04-H	●	50	4	22	40	10.7	R290-12T3..	4015-M3.5x11	80-T15	2508-M10x30
AFM90-R290.12-D063-A22-Z05-H	●	63	5	22	40	10.7				2510-M12x35
AFM90-R290.12-D080-A27-Z07-H	●	80	7	27	50	10.7				2514-M16x35
AFM90-R290.12-D100-A32-Z09-H	●	100	9	32	50	10.7				-
AFM90-R290.12-D125-B40-Z11	●	125	11	40	63	10.7				-

SNDVK Ucuna Uygunur. / Compatible with SNDVK Insert. / Под пластину SNDVK

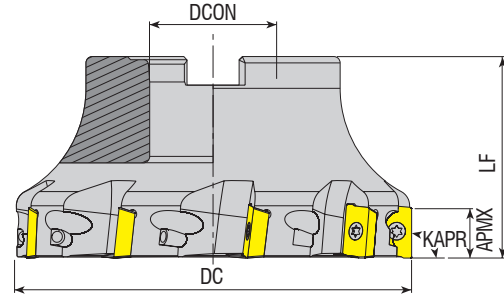

Takım Kodu Ordering Code Код для заказа	Stok Stock Наличие	Takım Ölçüleri (mm) Dimension (mm) Размеры (мм)					Kesici Uç Insert Пластина	Yedek Parçaları / Spare Parts / Запасные части		
		DC	ZEFP	DCON	LF	APMX		Sikma Vidası Screw Зажимной винт	Tork Anahtar Torx Key Торх Ключ	Montaj Vidası Mounting Screw Монтажный винт
AFM90-R390.11-D040-A16-Z05-H	●	40	5	16	40	10	R390-11T3..	3008-M2.5x6	80-T08	2506-M8x30
AFM90-R390.11-D050-A22-Z06-H	●	50	6	22	40	10				2508-M10x30
AFM90-R390.11-D063-A22-Z07-H	●	63	7	22	40	10				2510-M12x35
AFM90-R390.11-D080-A27-Z09-H	●	80	9	27	50	10				2506-M8x30
AFM90-R390.17-D040-A16-Z04-H	●	40	4	16	40	15.4	R390-1704..	4015-M3.5x11	80-T15	2508-M10x30
AFM90-R390.17-D050-A22-Z05-H	●	50	5	22	40	15.4				2510-M12x35
AFM90-R390.17-D063-A22-Z06-H	●	63	6	22	40	15.4				2514-M16x35
AFM90-R390.17-D080-A27-Z07-H	●	80	7	27	50	15.4				-
AFM90-R390.17-D100-A32-Z08-H	●	100	8	32	50	15.4				2508-M10x30
AFM90-R390.17-D125-B40-Z09	●	125	9	40	63	15.4	R390-1806..	4015-M4x11	80-T15	2510-M12x35
AFM90-R390.18-D050-A22-Z04-H	●	50	4	22	40	15.4				2514-M16x35
AFM90-R390.18-D063-A22-Z05-H	●	63	5	22	40	15.4				-
AFM90-R390.18-D080-A27-Z06-H	●	80	6	27	50	15.4				2508-M10x30
AFM90-R390.18-D100-A32-Z07-H	●	100	7	32	50	15.4	R390-1806..	4015-M4x11	80-T15	2510-M12x35
AFM90-R390.18-D125-B40-Z08	●	125	8	40	63	15.4				2514-M16x35

R: Sağ / Right / Правый L: Sol / Left / Левый

● Stokta / In Stock / В наличии ○ Stokta Yok / Non Stock Item / Нет в наличии

SNDVK Ucuna Uygunur. / Compatible with SNDVK Insert. / Под пластину SNDVK

Sipariş Örneği/Ordering Example/Bestellbeispiel

1 ad./pcs./шт. AFM90-R290.12-D050-A22-Z04-H

Kesme Hesabı : S 367 / Cutting Calculation : P 367 / Расчет режимов резания: стр. 367

Montaj Ölçüleri : S 364 / Mounting Reference : P 364 / Инструкция по установке фрез: стр. 364

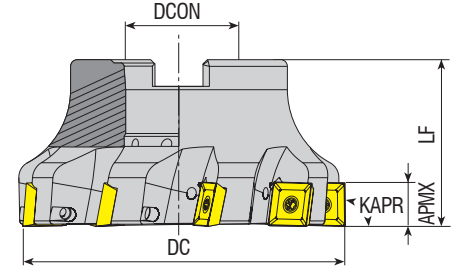

Takım Kodu Ordering Code Код для заказа	Stok Stock Наличие	Takım Ölçüleri (mm) Dimension (mm) Размеры (мм)					Kesici Uç Insert Пластина	Yedek Parçaları / Spare Parts / Запасные части		
		DC	ZEFP	DCON	LF	APMX		Sıkma Vidası Screw Зажимной винт	Tork Anahtar Torx Key Торх Ключ	Montaj Vidası Mounting Screw Монтажный винт
AFM90-490R08-D063-A22-Z06-H	●	63	6	22	40	5.5				
AFM90-490R14-D050-A22-Z04-H	●	50	4	22	40	10				
AFM90-490R14-D063-A22-Z05-H	●	63	5	22	40	10				
AFM90-490R14-D080-A27-Z07-H	●	80	7	27	50	10				
AFM90-490R14-D100-A32-Z07-H	●	100	7	32	50	10				
AFM90-490R14-D125-B40-Z08	●	125	8	40	63	10				
AFM90-490R14-D160-C40-Z12	●	160	12	40	63	10				
AFM90-490R14-D200-C60-Z16	●	200	16	60	63	10				

SNDVK Ucuna Uygundur. / Compatible with SNDVK Insert. / Под пластину SNDVK

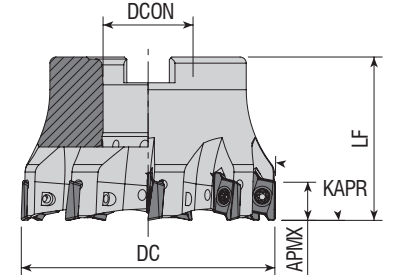

Takım Kodu Ordering Code Код для заказа	Stok Stock Наличие	Takım Ölçüleri (mm) Dimension (mm) Размеры (мм)					Kesici Uç Insert Пластина	Yedek Parçaları / Spare Parts / Запасные части		
		DC	ZEFP	DCON	LF	APMX		Sıkma Vidası Screw Зажимной винт	Tork Anahtar Torx Key Торх Ключ	Montaj Vidası Mounting Screw Монтажный винт
AFM90-RT10-D040-A16-Z06-H	●	40	6	16	40	10				
AFM90-RT10-D050-A22-Z07-H	●	50	7	22	40	10				
AFM90-RT10-D063-A22-Z09-H	●	63	9	22	40	10				

R: Sağ / Right / Правый L: Sol / Left / Левый
● Stokta / In Stock / В наличии ○ Stokta Yok / Non Stock Item / Нет в наличии
SFTY Ucuna Uygundur. / Compatible with SFTY Insert. / Под пластину SFTY

Sipariş Örneği/Ordering Example/ Bestellbeispiel
1 ad./pcs./шт. AFM90-490R08-D063-A22-Z06-H

Kesme Hesabı : S 367 / Cutting Calculation : P 367 / Расчет режимов резания: стр. 367
Montaj Ölçüleri : S 364 / Mounting Reference : P 364 / Инструкция по установке фрез: стр. 364

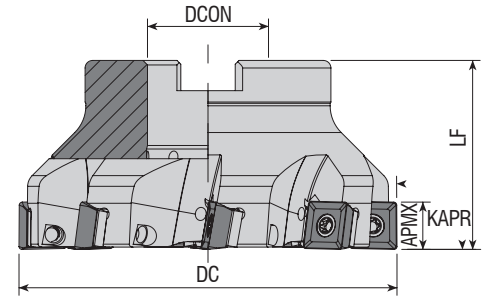

Takım Kodu Ordering Code Код для заказа	Stok Stock Наличие	Takım Ölçüleri (mm) Dimension (mm) Размеры (мм)					Kesici Uç Insert Пластина	Yedek Parçaları / Spare Parts / Запасные части					
		DC	ZEPF	DCON	LF	APMX		Altlık Screw Unterlage	Baskı Parçası Wedge Clamp Прижим	Sıkma Vidası Screw Зажимной винт	Tork Anahtar Torx Key Торх Ключ	Montaj Vidası Mounting Screw Монтажный винт	
AFM90S-SD1204-D050-A22-Z04-H	●	50	4	22	40	11	SDMT 1204..	AASD-3-0001	AAV-08-M3.5x8	4015-M3.5x12	80-T15	2408-M10x30	
AFM90S-SD1204-D063-A22-Z05-H	●	63	5	22	40	11						2508-M10x30	
AFM90S-SD1204-D080-A27-Z06-H	●	80	6	27	50	11						2510-M12x35	
AFM90S-SD1204-D100-A32-Z08-H	●	100	8	32	50	11						2514-M16x35	
AFM90S-SD1204-D125-B40-Z10	●	125	10	40	63	11						-	
AFM90S-SD1204-D160-C40-Z12	●	160	12	40	63	11						-	

DJT Ucuna Uygunudur. / Compatible with DJT Insert. / Под пластину DJT

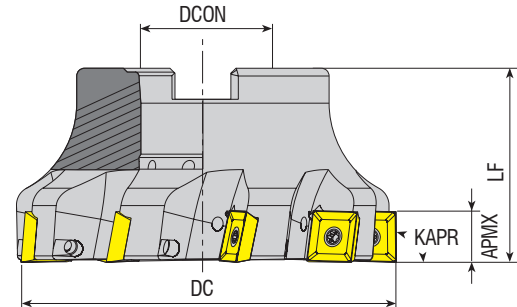

Takım Kodu Ordering Code Код для заказа	Stok Stock Наличие	Takım Ölçüleri (mm) Dimension (mm) Размеры (мм)					Kesici Uç Insert Пластина	Yedek Parçaları / Spare Parts / Запасные части		
		DC	ZEPF	DCON	LF	APMX		Sıkma Vidası Screw Зажимной винт	Tork Anahtar Torx Key Торх Ключ	Montaj Vidası Mounting Screw Монтажный винт
AFM90-SD09M4-D040-A16-Z04-H	●	40	4	16	40	9	SD.. 09M4..	4015-M3.5x11	80-T15	2406-M8x30
AFM90-SD09M4-D050-A22-Z05-H	●	50	5	22	40	9				2508-M10x30
AFM90-SD09M4-D063-A22-Z06-H	●	63	6	22	40	9				2510-M12x35
AFM90-SD09M4-D080-A27-Z07-H	●	80	7	27	50	9	SD.. 1305..	1020-M5x11	80-T20	2408-M10x30
AFM90-SD1305-D050-A22-Z04-H	●	50	4	22	40	13				2508-M10x30
AFM90-SD1305-D063-A22-Z05-H	●	63	5	22	40	13				2510-M12x35
AFM90-SD1305-D080-A27-Z06-H	●	80	6	27	50	13				2514-M16x35
AFM90-SD1305-D100-A32-Z07-H	●	100	7	32	50	13				-
AFM90-SD1305-D125-B40-Z08	●	125	8	40	63	13				-
AFM90-SD1305-D160-C40-Z10	●	160	10	40	63	13	-			

R: Sağ / Right / Правый L: Sol / Left / Левый

● Stokta / In Stock / В наличии ○ Stokta Yok / Non Stock Item / Нет в наличии

KRLY Ucuna Uygunudur. / Compatible with KRLY Insert. / Под пластину KRLY

Sipariş Örneği/Ordering Example/Bestellbeispiel

1 ad./pcs./шт. AFM90S-SD1204-D050-A22-Z04-H

Kesme Hesabı : S 367 / Cutting Calculation : P 367 / Расчет режимов резания: стр. 367

Montaj Ölçüleri : S 364 / Mounting Reference : P 364 / Инструкция по установке фрез: стр. 364

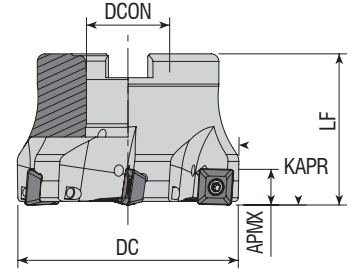

Takım Kodu Ordering Code Код для заказа	Stok Stock Наличие	Takım Ölçüleri (mm) Dimension (mm) Размеры (мм)					Kesici Uç Insert Пластина	Yedek Parçaları / Spare Parts / Запасные части		
		DC	ZEFP	DCON	LF	APMX		Sıkma Vidası Screw Зажимной винт	Tork Anahtar Torx Key Торх Ключ	Montaj Vidası Mounting Screw Монтажный винт
AFM90-SE09-D040-A16-Z04-H	●	40	4	16	40	6.7	SEET 09T3..	3008-M3x8	80-T08	2506-M8x30
AFM90-SE09-D050-A22-Z05-H	●	50	5	22	40	6.7				2508-M10x30
AFM90-SE09-D063-A22-Z06-H	●	63	6	22	40	6.7				-

ZCC Ucuna Uygunudur. / Compatible with ZCC Insert. / Под пластину HRN

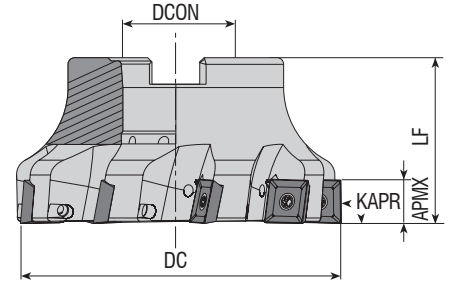

Takım Kodu Ordering Code Код для заказа	Stok Stock Наличие	Takım Ölçüleri (mm) Dimension (mm) Размеры (мм)					Kesici Uç Insert Пластина	Yedek Parçaları / Spare Parts / Запасные части		
		DC	ZEFP	DCON	LF	APMX		Sıkma Vidası Screw Зажимной винт	Tork Anahtar Torx Key Торх Ключ	Montaj Vidası Mounting Screw Монтажный винт
AFM90-SE12-D050-A22-Z04-H	●	50	4	22	40	12	SEET 1203..	4015-M3.5x11	80-T15	2508-M10x30
AFM90-SE12-D063-A22-Z05-H	●	63	5	22	40	12				2510-M12x35
AFM90-SE12-D080-A27-Z07-H	●	80	7	27	50	12				2514-M16x35
AFM90-SE12-D100-A32-Z09-H	●	100	9	32	50	12				-
AFM90-SE12-D125-B40-Z11	●	125	11	40	63	12				-

R: Sağ / Right / Правый L: Sol / Left / Левый
● Stokta / In Stock / В наличии ○ Stokta Yok / Non Stock Item / Нет в наличии
ZCC Ucuna Uygunudur. / Compatible with ZCC Insert. / Под пластину HRN

Sipariş Örneği/Ordering Example/Bestellbeispiel
1 ad./pcs./шт. AFM90-SE09-D040-A16-Z04-H

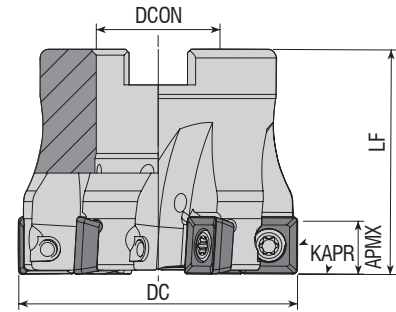

Takım Kodu Ordering Code Код для заказа	Stok Stock Наличие	Takım Ölçüleri (mm) Dimension (mm) Размеры (мм)					Kesici Uç Insert Пластина	Yedek Parçaları / Spare Parts / Запасные части		
		DC	ZEFP	DCON	LF	APMX		Sıkma Vidası Screw Зажимной винт	Tork Anahtar Torx Key Торк Ключ	Montaj Vidası Mounting Screw Монтажный винт
AFM90-SP1004-D040-A16-Z04-H	●	40	4	16	40	9.4	 SPMT 1004.. XPMT 1004.. QPMR 1004.. QPMT 1004..	 4015-M4x10	 80-T15	2506-M8x30
AFM90-SP1004-D050-A22-Z04-H	●	50	4	22	40	9.4				2508-M10x30
AFM90-SP1004-D050-A22-Z06-H	●	50	6	22	40	9.4				2510-M12x35
AFM90-SP1004-D063-A22-Z05-H	●	63	5	22	40	9.4				2514-M16x35
AFM90-SP1004-D080-A27-Z07-H	●	80	7	27	50	9.4				
AFM90-SP1004-D100-A32-Z08-H	●	100	8	32	50	9.4				

ISCR Ucuna Uygundur. / Compatiple with ISCR Insert. / Под пластину ISCR

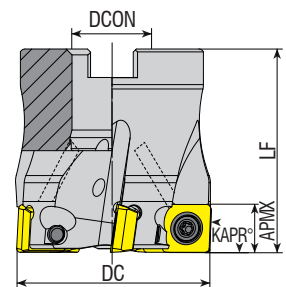

Takım Kodu Ordering Code Код для заказа	Stok Stock Наличие	Takım Ölçüleri (mm) Dimension (mm) Размеры (мм)					Kesici Uç Insert Пластина	Yedek Parçaları / Spare Parts / Запасные части		
		DC	ZEFP	DCON	LF	APMX		Sıkma Vidası Screw Зажимной винт	Tork Anahtar Torx Key Торк Ключ	Montaj Vidası Mounting Screw Монтажный винт
AFM90-SP09T3-D040-A16-Z05-H	●	40	5	16	40	8.6	 SPMT 09T3..	 3010-M3.5x9	 80-T10	2506-M8x30
AFM90-SP09T3-D050-A22-Z06-H	●	50	6	22	40	8.6				2508-M10x30
AFM90-SP09T3-D063-A22-Z07-H	●	63	7	22	40	8.6				2510-M12x35
AFM90-SP09T3-D080-A27-Z08-H	●	80	8	27	50	8.6				

R: Sağ / Right / Правый L: Sol / Left / Левый

● Stokta / In Stock / В наличии ○ Stokta Yok / Non Stock Item / Нет в наличии

SNDVK Ucuna Uygundur. / Compatiple with SNDVK Insert. / Под пластину SNDVK

Sipariş Örneği/Ordering Example/Bestellbeispiel

1 ad./pcs./шт. AFM90-SP1004-D040-A16-Z04-H

Kesme Hesabı : S 367 / Cutting Calculation : P 367 / Расчет режимов резания: стр. 367

Montaj Ölçüleri : S 364 / Mounting Reference : P 364 / Инструкция по установке фрез: стр. 364

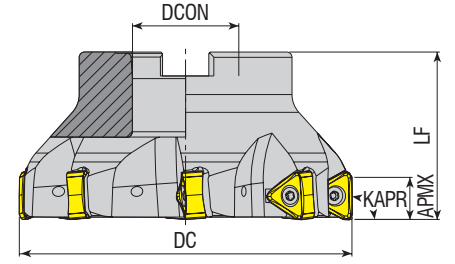

Takım Kodu Ordering Code Код для заказа	Stok Stock Наличие	Takım Ölçüleri (mm) Dimension (mm) Размеры (мм)					Kesici Uç Insert Пластина	Yedek Parçaları / Spare Parts / Запасные части		
		DC	ZEFP	DCON	LF	APMX		Sıkma Vidası Screw Зажимной винт	Tork Anahtar Torx Key Торх Ключ	Montaj Vidası Mounting Screw Монтажный винт
AFM90-TN2207-D063-A22-Z04-H	●	63	4	22	40	15	TN.X 2207..		80-T20	2508-M10x30
AFM90-TN2207-D080-A27-Z05-H	●	80	5	27	50	15				2510-M12x35
AFM90-TN2207-D100-B32-Z06	●	100	6	32	50	15				2514-M16x35
AFM90-TN2207-D125-B40-Z08	●	125	8	40	63	15				-

TGTC Ucuna Uyundur. / Compatible with TGTC Insert. / Под пластину TGTC

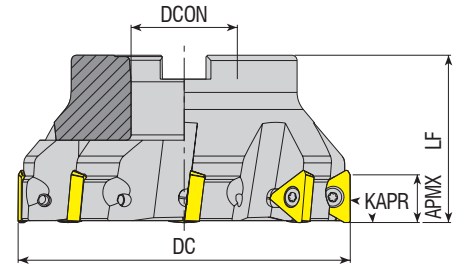

Takım Kodu Ordering Code Код для заказа	Stok Stock Наличие	Takım Ölçüleri (mm) Dimension (mm) Размеры (мм)					Kesici Uç Insert Пластина	Yedek Parçaları / Spare Parts / Запасные части		
		DC	ZEFP	DCON	LF	APMX		Sıkma Vidası Screw Зажимной винт	Tork Anahtar Torx Key Торх Ключ	Montaj Vidası Mounting Screw Монтажный винт
AFM90-TP2205-D063-A22-Z04	●	63	4	22	40	18	TPKT 2205..		80-T20	2508-M10x30
AFM90-TP2205-D080-A27-Z06	●	80	6	27	50	18				2510-M12x35
AFM90-TP2205-D100-A32-Z07	●	100	7	32	50	18				2514-M16x35
AFM90-TP2205-D125-B40-Z08	●	125	8	40	63	18				-
AFM90-TP2205-D160-C40-Z09	●	160	9	40	63	18				-
AFM90-TP2205-D200-C60-Z12	●	200	12	60	63	18				-

R: Sağ / Right / Правый L: Sol / Left / Левый
● Stokta / In Stock / В наличии ○ Stokta Yok / Non Stock Item / Нет в наличии
TGTC Ucuna Uyundur. / Compatible with TGTC Insert. / Под пластину TGTC

Sipariş Örneği/Ordering Example/ Bestellbeispiel
1 ad./pcs./шт. AFM90-TN2207-D063-A22-Z04-H

Kesme Hesabı : S 367 / Cutting Calculation : P 367 / Расчет режимов резания: стр. 367
Montaj Ölçüleri : S 364 / Mounting Reference : P 364 / Инструкция по установке фрез: стр. 364



KAPR=90°

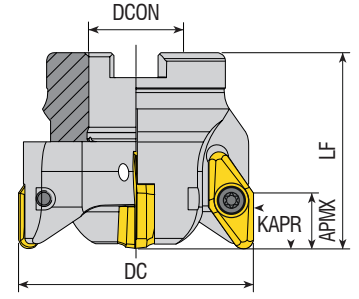

Takım Kodu Ordering Code Код для заказа	Stok Stock Наличие	Takım Ölçüleri (mm) Dimension (mm) Размеры (мм)					Kesici Uç Insert Пластина	Yedek Parçaları / Spare Parts / Запасные части					
		DC	ZEFP	DCON	LF	APMX		Sıkma Vidası Screw Зажимной винт	Tork Anahtar Torx Key Торк Ключ	Montaj Vidası Mounting Screw Монтажный винт			
AFM90-VC2205-D050-A22-Z03-H	●	50	3	22	55	15	VCKT 2205..						
AFM90-VC2205-D063-A22-Z04-H	●	63	4	22	55	15					4015-M4.5x11	80-T15	2508-M10x30
AFM90-VC2205-D066-A27-Z04-H	●	66	4	27	55	15							2510-M12x35
AFM90-VC2205-D080-A27-Z05-H	●	80	5	27	60	15							

ISO Ucuna Uygundur. / Compatible with ISO Insert. / Под пластину ISO



KAPR=90°

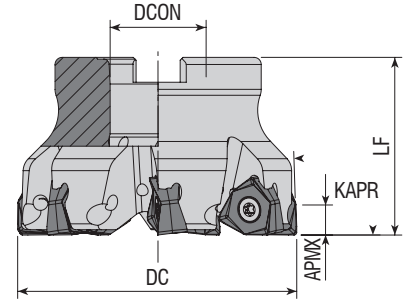

Takım Kodu Ordering Code Код для заказа	Stok Stock Наличие	Takım Ölçüleri (mm) Dimension (mm) Размеры (мм)					Kesici Uç Insert Пластина	Yedek Parçaları / Spare Parts / Запасные части					
		DC	ZEFP	DCON	LF	APMX		Sıkma Vidası Screw Зажимной винт	Tork Anahtar Torx Key Торк Ключ	Montaj Vidası Mounting Screw Монтажный винт			
AFM90-WNG04-D040-A16-Z06-H	●	40	6	16	40	4	WNGU 0403..						
AFM90-WNG04-D050-A22-Z05-H	●	50	5	22	40	4					3008-M2.5x6	80-T08	2506-M8x30
AFM90-WNG04-D050-A22-Z07-H	●	50	7	22	40	4							2508-M10x30
AFM90-WNG04-D063-A22-Z06-H	●	63	6	22	40	4							
AFM90-WNG08-D050-A22-Z05-H	●	50	5	22	40	7.5	WNGU 0806..						
AFM90-WNG08-D063-A22-Z06-H	●	63	6	22	40	7.5					4015-M4x11	80-T15	
AFM90-WNG08-D080-A27-Z07-H	●	80	7	27	50	7.5							2510-M12x35

R: Sağ / Right / Правый L: Sol / Left / Левый

● Stokta / In Stock / В наличии ○ Stokta Yok / Non Stock Item / Нет в наличии

XTC-GSC Ucuna Uygundur. / Compatible with XTC-GSC Insert. / Под пластину XTC-GSC

Sipariş Örneği/Ordering Example/Bestellbeispiel

1 ad./pcs./шт. AFM90-VC2205-D050-A22-Z03-H

Kesme Hesabı : S 367 / Cutting Calculation : P 367 / Расчет режимов резания: стр. 367

Montaj Ölçüleri : S 364 / Mounting Reference : P 364 / Инструкция по установке фрез: стр. 364

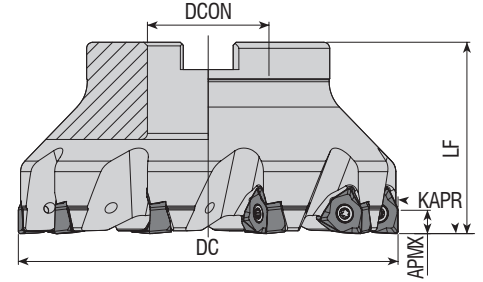

Takım Kodu Ordering Code Код для заказа	Stok Stock Наличие	Takım Ölçüleri (mm) Dimension (mm) Размеры (мм)					Kesici Uç Insert Пластина	Yedek Parçaları / Spare Parts / Запасные части		
		DC	ZEFP	DCON	LF	APMX		Sıkma Vidası Screw Зажимной винт	Tork Anahtar Torx Key Торх Ключ	Montaj Vidası Mounting Screw Монтажный винт
AFM90-WN0604Z-D040-A16-Z04-H	●	40	4	16	40	5.7	WNHU 0604..	3008-M3x8	80-T08	2506-M8x30
AFM90-WN0604Z-D050-A22-Z05-H	●	50	5	22	40	5.7				2508-M10x30
AFM90-WN0604Z-D063-A22-Z06-H	●	63	6	22	40	5.7				2510-M12x35
AFM90-WN0604Z-D080-A27-Z07-H	●	80	7	27	50	5.7				2514-M16x35
AFM90-WN0604Z-D100-A32-Z09-H	●	100	9	32	50	5.7				-
AFM90-WN0806Z-D050-A22-Z04-H	●	50	4	22	40	7.7	WNHU 0806..	4015-M4x11	80-T15	2508-M10x30
AFM90-WN0806Z-D063-A22-Z05-H	●	63	5	22	40	7.7				2510-M12x35
AFM90-WN0806Z-D080-A27-Z06-H	●	80	6	27	50	7.7				2514-M16x35
AFM90-WN0806Z-D100-A32-Z08-H	●	100	8	32	50	7.7				-
AFM90-WN0806Z-D125-B40-Z10	●	125	10	40	63	7.7				-
AFM90-WN0806Z-D160-C40-Z12	●	160	12	40	63	7.7	-	-	-	

ZCC Ucuna Uygunudur. / Compatible with ZCC Insert. / Под пластину HRN

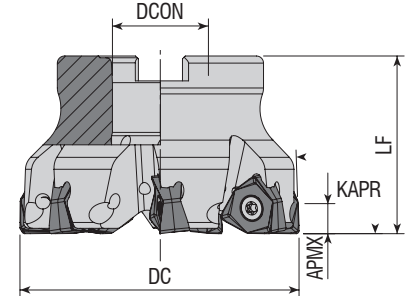

Takım Kodu Ordering Code Код для заказа	Stok Stock Наличие	Takım Ölçüleri (mm) Dimension (mm) Размеры (мм)					Kesici Uç Insert Пластина	Yedek Parçaları / Spare Parts / Запасные части		
		DC	ZEFP	DCON	LF	APMX		Sıkma Vidası Screw Зажимной винт	Tork Anahtar Torx Key Торх Ключ	Montaj Vidası Mounting Screw Монтажный винт
AFM90-WN0806-D050-A16-Z04-H	●	50	4	16	40	8	WNMX 080608	1615-M5x14	80-T15	2506-M8x30
AFM90-WN0806-D063-A22-Z05-H	●	63	5	22	40	8				2508-M10x30
AFM90-WN0806-D080-A27-Z07-H	●	80	7	27	50	8				2510-M12x35

R: Sağ / Right / Правый L: Sol / Left / Левый

● Stokta / In Stock / В наличии ○ Stokta Yok / Non Stock Item / Нет в наличии

KYCR-JD Ucuna Uygunudur. / Compatible with KYCR-JD Insert. / Под пластину KYCR-JD

Sipariş Örneği/Ordering Example/Bestellbeispiel

1 ad./pcs./шт. AFM90-WN0604Z-D040-A16-Z04-H

Kesme Hesabı : S 367 / Cutting Calculation : P 367 / Расчет режимов резания: стр. 367

Montaj Ölçüleri : S 364 / Mounting Reference : P 364 / Инструкция по установке фрез: стр. 364

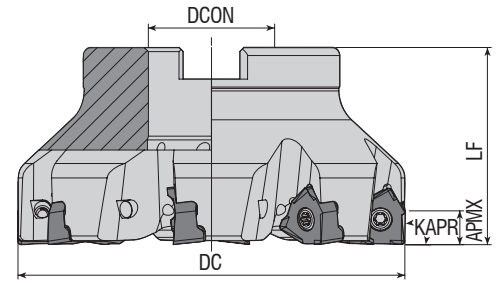

Takım Kodu Ordering Code Код для заказа	Stok Stock Наличие	Takım Ölçüleri (mm) Dimension (mm) Размеры (мм)					Kesici Uç Insert Пластина	Yedek Parçaları / Spare Parts / Запасные части					
		DC	ZEFP	DCON	LF	APMX		Sıkma Vidası Screw Зажимной винт	Tork Anahtar Torx Key Торх Ключ	Montaj Vidası Mounting Screw Монтажный винт			
AFM90-XN0403-D040-A16-Z05-H	●	40	5	16	40	4	XNEX 0403..	3008-M2.5x6	80-T08	2506-M8x30			
AFM90-XN0806-D050-A22-Z04-H	●	50	4	22	40	7.5				XNEX 0806..	4015-M4x11	80-T15	2508-M10x30
AFM90-XN0806-D063-A22-Z05-H	●	63	5	22	40	7.5							2510-M12x35
AFM90-XN0806-D080-A27-Z07-H	●	80	7	27	50	7.5							2514-M16x35
AFM90-XN0806-D100-A32-Z08-H	●	100	8	32	50	7.5							

SC Ucuna Uygunur. / Compatiple with SC Insert. / Под пластину SC

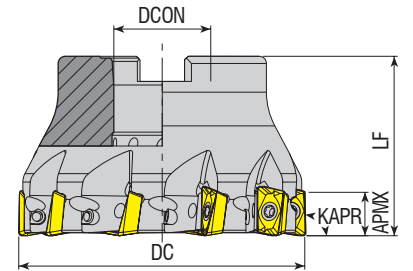

Takım Kodu Ordering Code Код для заказа	Stok Stock Наличие	Takım Ölçüleri (mm) Dimension (mm) Размеры (мм)					Kesici Uç Insert Пластина	Yedek Parçaları / Spare Parts / Запасные части			
		DC	ZEFP	DCON	LF	APMX		Sıkma Vidası Screw Зажимной винт	Tork Anahtar Torx Key Торх Ключ	Montaj Vidası Mounting Screw Монтажный винт	
AFM90-X012-D040-A16-Z05-H	●	40	5	16	40	11	XO.. 1204..	3010-M3.5x9	80-T10	2506-M8x30	
AFM90-X012-D050-A22-Z07-H	●	50	7	22	40	11				2508-M10x30	
AFM90-X012-D063-A22-Z08-H	●	63	8	22	40	11				2510-M12x35	
AFM90-X012-D080-A27-Z10-H	●	80	10	27	50	11				2514-M16x35	
AFM90-X012-D100-A32-Z12-H	●	100	12	32	50	11					

R: Sağ / Right / Правый L: Sol / Left / Левый

● Stokta / In Stock / В наличии ○ Stokta Yok / Non Stock Item / Нет в наличии

SC Ucuna Uygunur. / Compatiple with SC Insert. / Под пластину SC

Sipariş Örneği/Ordering Example/Bestellbeispiel

1 ad./pcs./шт. AFM90-XN0403-D040-A16-Z05-H

Kesme Hesabı : S 367 / Cutting Calculation : P 367 / Расчет режимов резания: стр. 367

Montaj Ölçüleri : S 364 / Mounting Reference : P 364 / Инструкция по установке фрез: стр. 364

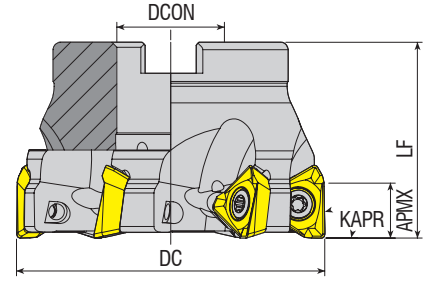

Takım Kodu Ordering Code Код для заказа	Stok Stock Наличие	Takım Ölçüleri (mm) Dimension (mm) Размеры (мм)					Kesici Uç Insert Пластина	Yedek Parçaları / Spare Parts / Запасные части		
		DC	ZEFP	DCON	LF	APMX		Sıkma Vidası Screw Зажимной винт	Tork Anahtar Torx Key Торх Ключ	Montaj Vidası Mounting Screw Монтажный винт
AFM90-3P1004-D040-A16-Z05-H	●	40	5	16	40	7	3PKT 1004..	1108-M2.5x6	80-T08	2506-M8x30
AFM90-3P1004-D050-A22-Z06-H	●	50	6	22	40	7				
AFM90-3P1505-D050-A22-Z04-H	●	50	4	22	40	11	3PKT 1505..	1115-M4x10	80-T15	2508-M10x30
AFM90-3P1505-D050-A22-Z05-H	●	50	5	22	40	11				
AFM90-3P1505-D063-A22-Z04-H	●	63	4	22	40	11				
AFM90-3P1505-D063-A22-Z06-H	●	63	6	22	40	11				
AFM90-3P1505-D080-A27-Z07-H	●	80	7	27	50	11				
AFM90-3P1505-D100-A32-Z08-H	●	100	8	32	50	11				
AFM90-3P1505-D125-B40-Z10	●	125	10	40	63	11				2510-M12x35 2514-M16x35 -

TGTC Ucuna Uygundur. / Compatible with TGTC Insert. / Под пластину TGTC

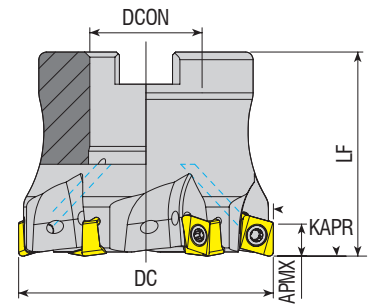

Takım Kodu Ordering Code Код для заказа	Stok Stock Наличие	Takım Ölçüleri (mm) Dimension (mm) Размеры (мм)					Kesici Uç Insert Пластина	Yedek Parçaları / Spare Parts / Запасные части		
		DC	ZEFP	DCON	LF	APMX		Sıkma Vidası Screw Зажимной винт	Tork Anahtar Torx Key Торх Ключ	Montaj Vidası Mounting Screw Монтажный винт
AFM90-4N06-D040-A16-Z05-H	●	40	5	16	40	6	4NKT 0603..	1108-M3x6.8	80-T08	2506-M8x30 2508-M10x30
AFM90-4N06-D050-A22-Z06-H	●	50	6	22	40	6				

R: Sağ / Right / Правый L: Sol / Left / Левый

● Stokta / In Stock / В наличии ○ Stokta Yok / Non Stock Item / Нет в наличии
TGTC Ucuna Uygundur. / Compatible with TGTC Insert. / Под пластину TGTC

Sipariş Örneği/Ordering Example/Bestellbeispiel
1 ad./pcs./шт. AFM90-3P1004-D040-A16-Z05-H

Kesme Hesabı : S 367 / Cutting Calculation : P 367 / Расчет режимов резания: стр. 367
Montaj Ölçüleri : S 364 / Mounting Reference : P 364 / Инструкция по установке фрез: стр. 364

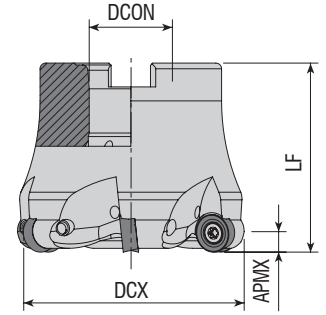

Takım Kodu Ordering Code Код для заказа	Stok Stock Наличие	Takım Ölçüleri (mm) Dimension (mm) Размеры (мм)					Kesici Uç Insert Пластина	Yedek Parçaları / Spare Parts / Запасные части			
		DCX	ZEFP	DCON	Lf	APMX		Sıkma Vidası Screw Зажимной винт	Tork Anahtar Torx Key Торх Ключ	Montaj Vidası Mounting Screw Монтажный винт	
AFMR-RC10T3-D040-A16-Z04-H	●	40	4	16	40	5	RC.. 10T3..	4015-M4x11	80-T15	2406-M8x30	
AFMR-RC10T3-D050-A22-Z05-H	●	50	5	22	50	5				2508-M10x30	
AFMR-RC10T3-D063-A22-Z06-H	●	63	6	22	50	5					

ZCC Ucuna Uygun. / Compatible with ZCC Insert. / Под пластину HRN

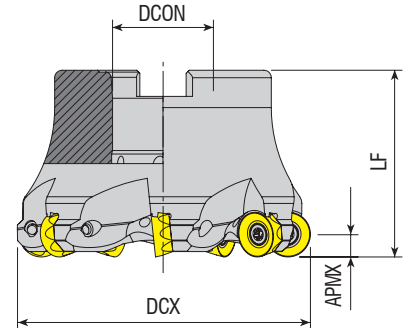

Takım Kodu Ordering Code Код для заказа	Stok Stock Наличие	Takım Ölçüleri (mm) Dimension (mm) Размеры (мм)					Kesici Uç Insert Пластина	Yedek Parçaları / Spare Parts / Запасные части			
		DCX	ZEFP	DCON	Lf	APMX		Sıkma Vidası Screw Зажимной винт	Tork Anahtar Torx Key Торх Ключ	Montaj Vidası Mounting Screw Монтажный винт	
AFMR-RC1204-D040-A16-Z04-H	●	40	4	16	40	6	RC.. 1204..	4015-M3.5x11	80-T15	2506-M8x30	
AFMR-RC1204-D050-A22-Z05-H	●	50	5	22	50	6				2508-M10x30	
AFMR-RC1204-D052-A22-Z05-H	●	52	5	22	50	6					
AFMR-RC1204-D063-A22-Z06-H	●	63	6	22	50	6					
AFMR-RC1204-D063-A27-Z06-H	●	80	6	27	50	6					
AFMR-RC1204-D080-A27-Z07-H	●	80	7	27	50	6				2510-M12x35	

R: Sağ / Right / Правый L: Sol / Left / Левый

● Stokta / In Stock / В наличии ○ Stokta Yok / Non Stock Item / Нет в наличии

SNDVK Ucuna Uygun. / Compatible with SNDVK Insert. / Под пластину SNDVK

Sipariş Örneği/Ordering Example/Bestellbeispiel
1 ad./pcs./шт. AFMR-RC10T3-D040-A16-Z04-H

Kesme Hesabı : S 367 / Cutting Calculation : P 367 / Расчет режимов резания: стр. 367

Montaj Ölçüleri : S 364 / Mounting Reference : P 364 / Инструкция по установке фрез: стр. 364

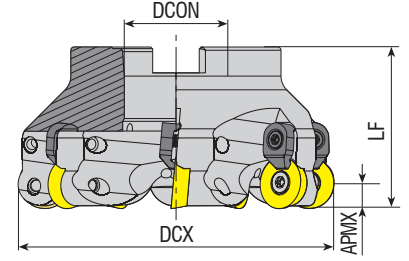

Takım Kodu Ordering Code Код для заказа	Stok Stock Наличие	Takım Ölçüleri (mm) Dimension (mm) Размеры (мм)					Kesici Uç Insert Пластина	Yedek Parçaları / Spare Parts / Запасные части				
		DCX	ZEFP	DCON	LF	APMX		Sıkma Vidası Screw Зажимной винт	Baskı Parçası Wedge Clamp Прижим	Baskı Vidası Clamp Screw Зажимной винт	Tork Anahtar Torx Key Торх Ключ	Montaj Vidası Mounting Screw Монтажный винт
AFMR-RD0702-D050-A22-Z06-H	●	50	6	22	40	3.5	RD.. 0702	3008-M2.5x6	-	-	80-T08	2407-M10x30
AFMR-RD0803-D050-A22-Z05-H	●	50	5	22	40	4	RD.. 0803	3008-M3x8	-	-	80-T08	2407-M10x30
AFMRC-RD1003-D040-A16-Z04-H	●	40	4	16	40	5	RD.. 1003					2406-M8x30
AFMRC-RD1003-D050-A22-Z05-H	●	50	5	22	50	5						2508-M10x30
AFMRC-RD1003-D052-A22-Z05	●	52	5	22	50	5						2510-M12x35
AFMRC-RD1003-D063-A22-Z06-H	●	63	6	22	50	5						2514-M16x35
AFMRC-RD1003-D080-A27-Z07-H	●	80	7	27	50	5						2514-M16x35
AFMRC-RD1003-D100-A32-Z08-H	●	100	8	32	50	5	RD.. 10T3					2508-M10x30
AFMRC-RD10T3-D050-A22-Z05-H	●	50	5	22	50	5						2508-M10x30
AFMRC-RD10T3-D063-A22-Z06-H	●	63	6	22	50	5	RD.. 12T3	4015-M3.5x11	ACK-15	4015-M3.5x11	80-T15	2406-M8x30
AFMRC-RD12T3-D040-A16-Z04-H	●	40	4	16	40	6						2508-M10x30
AFMRC-RD12T3-D050-A22-Z05-H	●	50	5	22	50	6						2510-M12x35
AFMRC-RD12T3-D052-A22-Z05-H	●	52	5	22	50	6						2514-M16x35
AFMRC-RD12T3-D063-A22-Z06-H	●	63	6	22	50	6						2514-M16x35
AFMRC-RD12T3-D080-A27-Z07-H	●	80	7	27	50	6	RD.. 1204					-
AFMRC-RD12T3-D100-A32-Z08-H	●	100	8	32	50	6						2406-M8x30
AFMRC-RD12T3-D125-B40-Z09	●	125	9	40	63	6						2508-M10x30
AFMRC-RD1204-D040-A16-Z04-H	●	40	4	16	40	6						2510-M12x35
AFMRC-RD1204-D050-A22-Z05-H	●	50	5	22	50	6						2514-M16x35
AFMRC-RD1204-D052-A22-Z05-H	●	52	5	22	50	6	RD.. 1604	4015-M4.5x11	ACK-05	4015-M4x11		2408-M10x30
AFMRC-RD1204-D063-A22-Z06-H	●	63	6	22	50	6						2508-M10x30
AFMRC-RD1204-D080-A27-Z07-H	●	80	7	27	50	6						2510-M12x35
AFMRC-RD1204-D100-A32-Z07-H	●	100	7	32	50	6						2514-M16x35
AFMRC-RD1204-D100-A32-Z08-H	●	100	8	32	50	6						2514-M16x35
AFMRC-RD1604-D050-A22-Z04-H	●	50	4	22	50	8	RD.. 1604	4015-M4.5x11	ACK-05	4015-M4x11		2408-M10x30
AFMRC-RD1604-D052-A22-Z04-H	●	52	4	22	50	8						2508-M10x30
AFMRC-RD1604-D063-A22-Z05-H	●	63	5	22	50	8						2510-M12x35
AFMRC-RD1604-D066-A22-Z05-H	●	66	5	22	50	8						2514-M16x35
AFMRC-RD1604-D066-A27-Z05-H	●	66	5	27	50	8						2514-M16x35
AFMRC-RD1604-D080-A27-Z06-H	●	80	6	27	50	8						2514-M16x35
AFMRC-RD1604-D100-A32-Z07-H	●	100	7	32	50	8						2514-M16x35
AFMRC-RD1604-D125-B40-Z07	●	125	7	40	63	8						-
AFMRC-RD1604-D160-C40-Z08	●	160	8	40	63	8						-

R: Sağ / Right / Правый L: Sol / Left / Левый

● Stokta / In Stock / В наличии ○ Stokta Yok / Non Stock Item / Нет в наличии

ISO Ucuna Uygun. / Compatible with ISO Insert. / Под пластины ISO

Sipariş Örneği/Ordering Example/Bestellbeispiel

1 ad./pcs./шт. AFMR-RD0702-D050-A22-Z06-H

Kesme Hesabı : S 367 / Cutting Calculation : P 367 / Расчет режимов резания: стр. 367

Montaj Ölçüleri : S 364 / Mounting Reference : P 364 / Инструкция по установке фрез: стр. 364

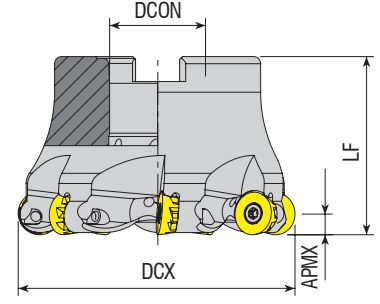

Takım Kodu Ordering Code Код для заказа	Stok Stock Наличие	Takım Ölçüleri (mm) Dimension (mm) Размеры (мм)					Kesici Uç Insert Пластина	Yedek Parçaları / Spare Parts / Запасные части			
		DCX	ZEFP	DCON	LF	APMX		Sıkma Vidası Screw Зажимной винт	Tork Anahtar Torx Key Торк Ключ	Montaj Vidası Mounting Screw Монтажный винт	
AFMR-RP10T3-D063-A22-Z06-H	●	63	6	22	40	5	RPNX 10T3..	4010-M3x8	80-T10	2508-M10x30	
AFMR-RP10T3-D080-A27-Z07-H	●	80	7	27	50	5				2510-M12x35	
AFMR-RP1204-D040-A16-Z04-H	●	40	4	16	40	6	RPNX 1204..	4015-M3.5x11	80-T15	2406-M8x30	
AFMR-RP1204-D080-A27-Z07-H	●	80	7	27	50	6				2510-M12x35	

CRTZT Ucuna Uygunur. / Compatible with CRTZT Insert. / Под пластину CRTZT

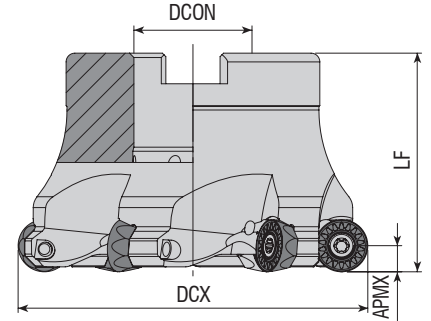

Takım Kodu Ordering Code Код для заказа	Stok Stock Наличие	Takım Ölçüleri (mm) Dimension (mm) Размеры (мм)					Kesici Uç Insert Пластина	Yedek Parçaları / Spare Parts / Запасные части			
		DCX	ZEFP	DCON	LF	APMX		Sıkma Vidası Screw Зажимной винт	Tork Anahtar Torx Key Торк Ключ	Montaj Vidası Mounting Screw Монтажный винт	
AFMR-RP1204M-D050-A22-Z04-H	●	50	4	22	50	6	RPMT 1204..	4015-M4x11	80-T15	2508-M10x30	
AFMR-RP1204M-D052-A22-Z05-H	●	52	5	22	50	6				2510-M12x35	
AFMR-RP1204M-D063-A22-Z05-H	●	63	5	22	50	6					
AFMR-RP1204M-D080-A27-Z06-H	●	80	6	27	50	6					

R: Sağ / Right / Правый L: Sol / Left / Левый

● Stokta / In Stock / В наличии ○ Stokta Yok / Non Stock Item / Нет в наличии

MTSBH Ucuna Uygunur. / Compatible with MTSBH Insert. / Под пластину MTSBH

Sipariş Örneği/Ordering Example/Bestellbeispiel
1 ad./pcs./шт. AFMR-RP10T3-D063-A22-Z06-H

Kesme Hesabı : S 367 / Cutting Calculation : P 367 / Расчет режимов резания: стр. 367

Montaj Ölçüleri : S 364 / Mounting Reference : P 364 / Инструкция по установке фрез: стр. 364

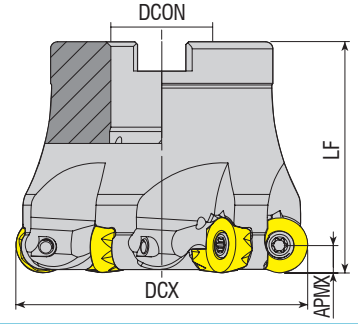

Takım Kodu Ordering Code Код для заказа	Stok Stock Наличие	Takım Ölçüleri (mm) Dimension (mm) Размеры (мм)					Kesici Uç Insert Пластина	Yedek Parçaları / Spare Parts / Запасные части		
		DCX	ZEFP	DCON	LF	APMX		Sıkma Vidası Screw Зажимной винт	Tork Anahtar Torx Key Торкс Ключ	Montaj Vidası Mounting Screw Монтажный винт
AFMR-RY10-D040-A16-Z04-H	●	40	4	16	40	5	RYMX 1004..	4015-M3.5x11	80-T15	2406-M8x30
AFMR-RY10-D040-A16-Z05-H	●	40	5	16	40	5				2506-M8x30
AFMR-RY10-D050-A22-Z05-H	●	50	5	22	50	5				2508-M10x30
AFMR-RY10-D063-A22-Z06-H	●	63	6	22	50	5				2406-M8x30
AFMR-RY12-D040-A16-Z04-H	●	40	4	16	40	6	RYMX 1205..	4015-M4x11	80-T15	2406-M8x30
AFMR-RY12-D050-A22-Z05-H	●	50	5	22	50	6				2508-M10x30
AFMR-RY12-D052-A22-Z05-H	●	52	5	22	50	6				2510-M12x35
AFMR-RY12-D063-A22-Z06-H	●	63	6	22	50	6				2514-M16x35
AFMR-RY12-D080-A27-Z06-H	●	80	6	27	50	6				
AFMR-RY12-D100-A32-Z07-H	●	100	7	32	50	6				

TGTC Ucuna Uygundur. / Compatible with TGTC Insert. / Под пластину TGTC

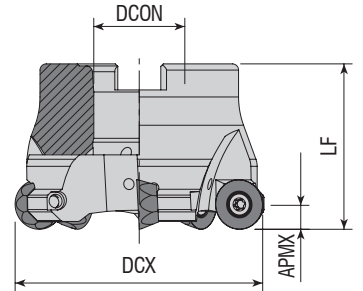

Takım Kodu Ordering Code Код для заказа	Stok Stock Наличие	Takım Ölçüleri (mm) Dimension (mm) Размеры (мм)					Kesici Uç Insert Пластина	Yedek Parçaları / Spare Parts / Запасные части		
		DCX	ZEFP	DCON	LF	APMX		Sıkma Vidası Screw Зажимной винт	Tork Anahtar Torx Key Торкс Ключ	Montaj Vidası Mounting Screw Монтажный винт
AFMR-QP10T3-D040-A16-Z04-H	●	40	4	16	40	5	QP. 10T3..	4015-M3.5x11	80-T15	2506-M8x30
AFMR-QP10T3-D050-A22-Z05-H	●	50	5	22	40	5				2407-M10x30
AFMR-QP10T3-D063-A22-Z06-H	●	63	6	22	40	5				
AFMR-QP1204-D050-A22-Z04-H	●	50	4	22	40	6	QP. 1204..	4015-M4x11		
AFMR-QP1204-D063-A22-Z05-H	●	63	5	22	40	6				

R: Sağ / Right / Правый L: Sol / Left / Левый

● Stokta / In Stock / В наличии ○ Stokta Yok / Non Stock Item / Нет в наличии

SMTM Ucuna Uygundur. / Compatible with SMTM Insert. / Под пластину SMTM

Sipariş Örneği/Ordering Example/Bestellbeispiel

1 ad./pcs./шт. AFMR-RY10-D040-A16-Z04-H

Kesme Hesabı : S 367 / Cutting Calculation : P 367 / Расчет режимов резания: стр. 367

Montaj Ölçüleri : S 364 / Mounting Reference : P 364 / Инструкция по установке фрез: стр. 364

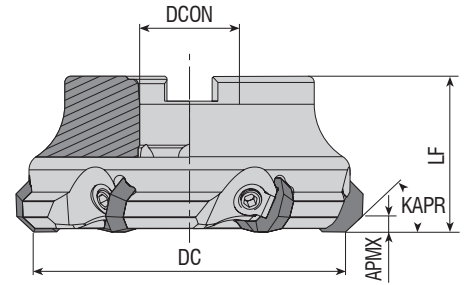

Takım Kodu Ordering Code Код для заказа	Stok Stock Наличие	Takım Ölçüleri (mm) Dimension (mm) Размеры (мм)					Kesici Uç Insert Пластина	Yedek Parçaları / Spare Parts / Запасные части				
		DC	ZEFP	DCON	LF	APMX		Baskı Parçası Wedge Clamp Прижим	Baskı Vidası Clamp Screw Зажимной винт	Anahtar Allen Key Ключ	Montaj Vidası Mounting Screw Монтажный винт	
AFM43C-OF07-D063-A22-Z04	●	63	4	22	45	5	OF.. 0704..	ACK-11	AKV-15-M8x1x20	AAL-05-4		2508-M10x30
AFM43C-OF07-D080-A27-Z05	●	80	5	27	50	5						2510-M12x35
AFM43C-OF07-D100-A32-Z06	●	100	6	32	50	5						2514-M16x35
AFM43C-OF07-D125-B40-Z08	●	125	8	40	63	5						-
AFM43C-OF07-D160-C40-Z09	●	160	9	40	63	5						-

ISO Ucuna Uygundur. / Compatible with ISO Insert. / Под пластину ISO

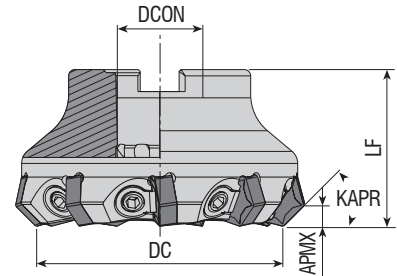

Takım Kodu Ordering Code Код для заказа	Stok Stock Наличие	Takım Ölçüleri (mm) Dimension (mm) Размеры (мм)					Kesici Uç Insert Пластина	Yedek Parçaları / Spare Parts / Запасные части				
		DC	ZEFP	DCON	LF	APMX		Baskı Parçası Wedge Clamp Прижим	Baskı Vidası Clamp Screw Зажимной винт	Anahtar Allen Key Ключ	Montaj Vidası Mounting Screw Монтажный винт	
AFM45C-HN0905-D063-A22-Z07	●	63	7	22	40	4.5	HN.. 0905..	ACK-11	AKV-15-M8x1x20	AAL-05-4		2508-M10x30
AFM45C-HN0905-D080-A27-Z09	●	80	9	27	50	4.5						2510-M12x35
AFM45C-HN0905-D100-A32-Z11	●	100	11	32	50	4.5						2514-M16x35
AFM45C-HN0905-D125-B40-Z13	●	125	13	40	63	4.5						-
AFM45CL-HN0905-D125-B40-Z10	●	125	10	40	63	4.5						-
AFM45C-HN0905-D160-C40-Z15	●	160	15	40	63	4.5	-					

R: Sağ / Right / Правый L: Sol / Left / Левый

● Stokta / In Stock / В наличии ○ Stokta Yok / Non Stock Item / Нет в наличии

WDA-KNMTL Ucuna Uygundur. / Compatible with WDA-KNMTL Insert. / Под пластину WDA-KNMTL

Sipariş Örneği/Ordering Example/Bestellbeispiel

1 ad./pcs./шт. AFM43C-OF07-D063-A22-Z04

Kesme Hesabı : S 367 / Cutting Calculation : P 367 / Расчет режимов резания: стр. 367

Montaj Ölçüleri : S 364 / Mounting Reference : P 364 / Инструкция по установке фрез: стр. 364

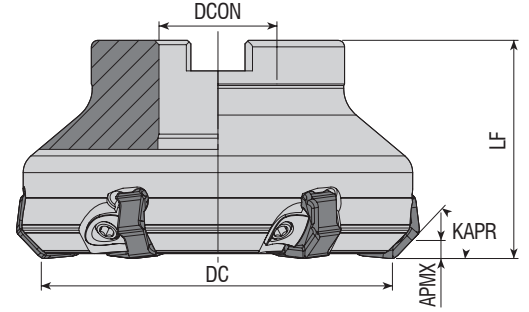

Takım Kodu Ordering Code Код для заказа	Stok Stock Наличие	Takım Ölçüleri (mm) Dimension (mm) Размеры (мм)					Kesici Uç Insert Пластина	Yedek Parçaları / Spare Parts / Запасные части			
		DC	ZEFP	DCON	LF	APMX		Baskı Parçası Wedge Clamp Прижим	Baskı Vidası Clamp Screw Зажимной винт	Anahtar Allen Key Ключ	Montaj Vidası Mounting Screw Монтажный винт
AFM45C-XN0806-D063-A22-Z05	●	63	5	22	50	4.5	XNMU 0806..	ACK-26	AKV-26-M6x0.75x20	AAL-03-03	2508-M10x30
AFM45C-XN0806-D080-A27-Z06	●	80	6	27	50	4.5					2510-M12x35
AFM45C-XN0806-D100-A32-Z08	●	100	8	32	50	4.5					2514-M16x35
AFM45C-XN0806-D125-B40-Z08	●	125	8	40	63	4.5					-
AFM45C-XN0806-D160-C40-Z10	●	160	10	40	63	4.5					-
AFM45C-XN0806-D200-C60-Z12	●	200	12	60	63	4.5					-

DJT Ucuna Uygunudur. / Compatible with DJT Insert. / Под пластину DJT

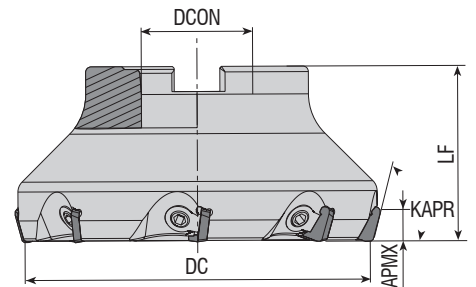

Takım Kodu Ordering Code Код для заказа	Stok Stock Наличие	Takım Ölçüleri (mm) Dimension (mm) Размеры (мм)					Kesici Uç Insert Пластина	Yedek Parçaları / Spare Parts / Запасные части			
		DC	ZEFP	DCON	LF	APMX		Baskı Parçası Wedge Clamp Прижим	Baskı Vidası Clamp Screw Зажимной винт	Anahtar Allen Key Ключ	Montaj Vidası Mounting Screw Монтажный винт
AFM75C-SP12-D050-A22-Z04	●	50	4	22	42	8	SPKN 1203..	ACK-10	AKV-22-M8x1x14	AAL-05-4	2508-M10x30
AFM75C-SP12-D063-A22-Z05	●	63	5	22	40	8					2510-M12x35
AFM75C-SP12-D080-A27-Z06	●	80	6	27	50	8					2514-M16x35
AFM75C-SP12-D100-A32-Z07	●	100	7	32	50	8					-
AFM75C-SP12-D125-B40-Z08	●	125	8	40	63	8					-
AFM75C-SP12-D160-C40-Z09	●	160	9	40	63	8					-
AFM75C-SP12-D200-C60-Z12	●	200	12	60	63	8	-				

R: Sağ / Right / Правый L: Sol / Left / Левый

● Stokta / In Stock / В наличии ○ Stokta Yok / Non Stock Item / Нет в наличии

ISO Ucuna Uygunudur. / Compatible with ISO Insert. / Под пластину ISO

Sipariş Örneği/Ordering Example/Bestellbeispiel

1 ad./pcs./шт. AFM45C-XN0806-D063-A22-Z05

Kesme Hesabı : S 367 / Cutting Calculation : P 367 / Расчет режимов резания: стр. 367

Montaj Ölçüleri : S 364 / Mounting Reference : P 364 / Инструкция по установке фрез: стр. 364

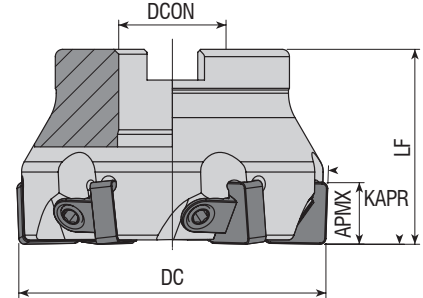

Takım Kodu Ordering Code Код для заказа	Stok Stock Наличие	Takım Ölçüleri (mm) Dimension (mm) Размеры (мм)					Kesici Uç Insert Пластина	Yedek Parçaları / Spare Parts / Запасные части			
		DC	ZEFP	DCON	LF	APMX		Baskı Parçası Wedge Clamp Прижим	Baskı Vidası Clamp Screw Зажимной винт	Anahtar Allen Key Ключ	Montaj Vidası Mounting Screw Монтажный винт
AFM88C-SN1204-D050-A22-Z05	●	50	5	22	40	11	SN.. 1204..	ACK-21	AKV-24-M6x1x1	AAL-03-3	2408-M10x30
AFM88C-SN1204-D063-A22-Z06	●	63	6	22	40	11					2510-M12x35
AFM88C-SN1204-D080-A27-Z07	●	80	7	27	50	11					2514-M16x35
AFM88C-SN1204-D100-A32-Z08	●	100	8	32	50	11					-
AFM88C-SN1204-D125-B40-Z11	●	125	11	40	63	11					-

UNIN-NT-KYCR Ucuna Uygundur. / Compatible with UNIN-NT-KYCR Insert. / Под пластину UNIN-NT-KYCR

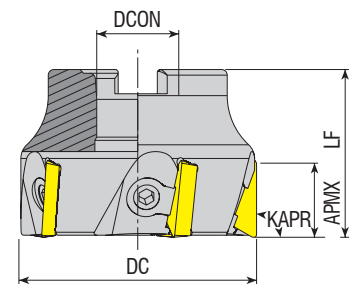

Takım Kodu Ordering Code Код для заказа	Stok Stock Наличие	Takım Ölçüleri (mm) Dimension (mm) Размеры (мм)					Kesici Uç Insert Пластина	Yedek Parçaları / Spare Parts / Запасные части			
		DC	ZEFP	DCON	LF	APMX		Baskı Parçası Wedge Clamp Прижим	Baskı Vidası Clamp Screw Зажимной винт	Anahtar Allen Key Ключ	Montaj Vidası Mounting Screw Монтажный винт
AFM90C-TP16-D050-A22-Z04	●	50	4	22	40	12	TP.. 1603..	ACK-10	AKV-22-M8x1x14 AKV-13-M8x1x16	AAL-05-4	2407-M10x30
AFM90C-TP16-D063-A22-Z06	●	63	6	22	45	12					2508-M10x30
AFM90C-TP16-D080-A27-Z07	●	80	7	27	50	12					2510-M12x35
AFM90C-TP16-D100-A32-Z08	●	100	8	32	50	12					2514-M16x35
AFM90C-TP16-D125-B40-Z08	●	125	8	40	63	12					-
AFM90C-TP22-D063-A22-Z05	●	63	5	22	45	18	TP.. 2204..	ACK-11	AKV-14-M8x1x18	AAL-05-4	2508-M10x30
AFM90C-TP22-D080-A27-Z06	●	80	6	27	50	18					2510-M12x35
AFM90C-TP22-D100-A32-Z07	●	100	7	32	50	18					2514-M16x35
AFM90C-TP22-D125-B40-Z08	●	125	8	40	63	18					-
AFM90C-TP22-D160-C40-Z09	●	160	9	40	63	18					-
AFM90C-TP22-D200-C60-Z12	●	200	12	60	63	18	-				
AFM90C-TP22-D250-C60-Z15	●	250	15	60	63	18	-				
AFM90C-TP22-D315-D60-Z18	●	315	18	60	63	18	-				

R: Sağ / Right / Правый L: Sol / Left / Левый

● Stokta / In Stock / В наличии ○ Stokta Yok / Non Stock Item / Нет в наличии

ISO Ucuna Uygundur. / Compatible with ISO Insert. / Под пластину ISO

Sipariş Örneği/Ordering Example/Bestellbeispiel

1 ad./pcs./шт. AFM88C-SN1204-D050-A22-Z05

Kesme Hesabı : S 367 / Cutting Calculation : P 367 / Расчет режимов резания: стр. 367

Montaj Ölçüleri : S 364 / Mounting Reference : P 364 / Инструкция по установке фрез: стр. 364

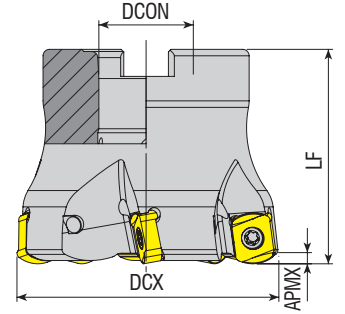

Takım Kodu Ordering Code Код для заказа	Stok Stock Наличие	Takım Ölçüleri (mm) Dimension (mm) Размеры (мм)					Kesici Uç Insert Пластина	Yedek Parçaları / Spare Parts / Запасные части		
		DCX	ZEFP	DCON	LF	APMX		Sıkma Vidası Screw Зажимной винт	Tork Anahtar Torx Key Торх Ключ	Montaj Vidası Mounting Screw Монтажный винт
AHFM-BL0603-D040-A16-Z06-H	●	40	6	16	40	1	BLMP 0603..	3008-M2.5x6	80-T08	2506-M8x30
AHFM-BL0603-D050-A22-Z07-H	●	50	7	22	40	1				
AHFM-BL0904-D040-A16-Z05-H	●	40	5	16	40	2	BLMP 0904..	3010-M3.5x9	80-T10	2508-M10x30
AHFM-BL0904-D050-A22-Z06-H	●	50	6	22	50	2				
AHFM-BL0904-D063-A22-Z05-H	●	63	5	22	50	2				
AHFM-BL0904-D063-A22-Z07-H	●	63	7	22	50	2				

TGTC Ucuna Uygunur. / Compatible with TGTC Insert. / Под пластину TGTC

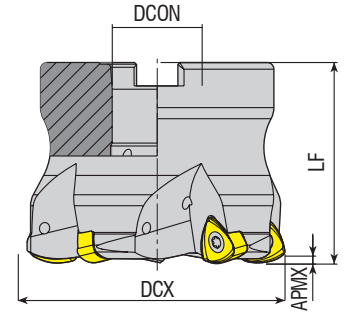

Takım Kodu Ordering Code Код для заказа	Stok Stock Наличие	Takım Ölçüleri (mm) Dimension (mm) Размеры (мм)					Kesici Uç Insert Пластина	Yedek Parçaları / Spare Parts / Запасные части		
		DCX	ZEFP	DCON	LF	APMX		Sıkma Vidası Screw Зажимной винт	Tork Anahtar Torx Key Торх Ключ	Montaj Vidası Mounting Screw Монтажный винт
AHFM-BL1205-D050-A22-Z03-H	●	50	3	22	40	2	BLMP 1205..	4015-M4x11	80-T15	2508-M10x30
AHFM-BL1205-D063-A22-Z04-H	●	63	4	22	40	2				
AHFM-BL1205-D080-A27-Z05-H	●	80	5	27	50	2				2510-M12x35

R: Sağ / Right / Правый L: Sol / Left / Левый

● Stokta / In Stock / В наличии ○ Stokta Yok / Non Stock Item / Нет в наличии
TGTC Ucuna Uygunur. / Compatible with TGTC Insert. / Под пластину TGTC

Sipariş Örneği/Ordering Example/Bestellbeispiel

1 ad./pcs./шт. AHFM-BL0603-D040-A16-Z06-H

Kesme Hesabı : S 367 / Cutting Calculation : P 367 / Расчет режимов резания: стр. 367

Montaj Ölçüleri : S 364 / Mounting Reference : P 364 / Инструкция по установке фрез: стр. 364

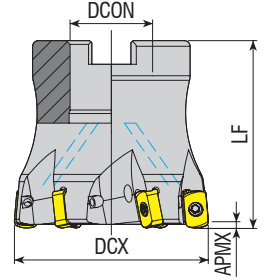

Takım Kodu Ordering Code Код для заказа	Stok Stock Наличие	Takım Ölçüleri (mm) Dimension (mm) Размеры (мм)					Kesici Uç Insert Пластина	Yedek Parçaları / Spare Parts / Запасные части						
		DCX	ZEFP	DCON	LF	APMX		Sıkma Vidası Screw Зажимной винт	Tork Anahtar Torx Key Торх Ключ	Montaj Vidası Mounting Screw Монтажный винт				
AHFM-EN1004-D050-A22-Z05-H	●	50	5	22	50	1								
AHFM-EN1004-D050-A22-Z06-H	●	50	6	22	50	1								
AHFM-EN1004-D052-A22-Z06-H	●	52	6	22	50	1					ENMU 1004..	3008-M2.5X6	80-T08	2508-M10x30
AHFM-EN1004-D063-A22-Z06-H	●	63	6	22	50	1								

DJT Ucuna Uygunudur. / Compatible with DJT Insert. / Под пластину DJT

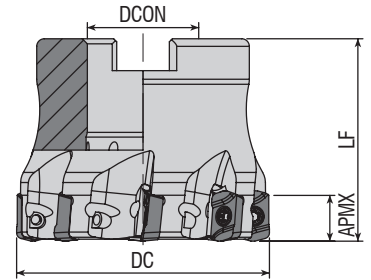

Takım Kodu Ordering Code Код для заказа	Stok Stock Наличие	Takım Ölçüleri (mm) Dimension (mm) Размеры (мм)					Kesici Uç Insert Пластина	Yedek Parçaları / Spare Parts / Запасные части			
		DC	ZEFP	DCON	LF	APMX		Sıkma Vidası Screw Зажимной винт	Tork Anahtar Torx Key Торх Ключ	Montaj Vidası Mounting Screw Монтажный винт	
AHFM-EP1003-D050-A22-Z08-H	●	50	8	22	40	1					
AHFM-EP1003-D063-A22-Z08-H	●	63	8	22	40	1					EP. 1003.. ZPMT 1003.. YPHW 1003..

R: Sağ / Right / Правый L: Sol / Left / Левый

● Stokta / In Stock / В наличии ○ Stokta Yok / Non Stock Item / Нет в наличии

DJT Ucuna Uygunudur. / Compatible with DJT Insert. / Под пластину DJT

Sipariş Örneği/Ordering Example/Bestellbeispiel

1 ad./pcs./шт. AHFM-EN1004-D050-A22-Z05-H

Kesme Hesabı : S 367 / Cutting Calculation : P 367 / Расчет режимов резания: стр. 367

Montaj Ölçüleri : S 364 / Mounting Reference : P 364 / Инструкция по установке фрез: стр. 364

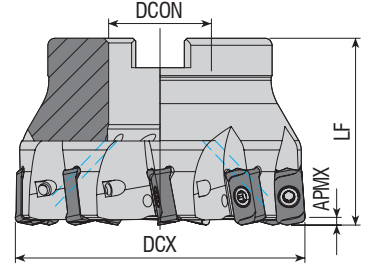

Takım Kodu Ordering Code Код для заказа	Stok Stock Наличие	Takım Ölçüleri (mm) Dimension (mm) Размеры (мм)					Kesici Uç Insert Пластина	Yedek Parçaları / Spare Parts / Запасные части				
		DCX	ZEFP	DCON	LF	APMX		Sıkma Vidası Screw Зажимной винт	Tork Anahtar Torx Key Торх Ключ	Montaj Vidası Mounting Screw Монтажный винт		
AHFM-L003-D040-A16-Z06-H	●	40	6	16	40	1	LOGU 0303..			2506-M8x30		
AHFM-L003-D050-A22-Z07-H	●	50	7	22	40	1				1108-M3x6.8	80-T08	2508-M10x30
AHFM-L003-D063-A22-Z09-H	●	63	9	22	40	1						

KYCR Ucuna Uygunur. / Compatiple with KYCR Insert. / Под пластину KYCR

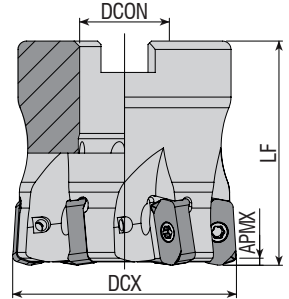

Takım Kodu Ordering Code Код для заказа	Stok Stock Наличие	Takım Ölçüleri (mm) Dimension (mm) Размеры (мм)					Kesici Uç Insert Пластина	Yedek Parçaları / Spare Parts / Запасные части				
		DCX	ZEFP	DCON	LF	APMX		Sıkma Vidası Screw Зажимной винт	Tork Anahtar Torx Key Торх Ключ	Montaj Vidası Mounting Screw Монтажный винт		
AHFM-LN0303-D040-A16-Z06-H	●	40	6	16	40	12	LNMU 0303..			2506-M8x30		
AHFM-LN0303-D050-A22-Z07-H	●	50	7	22	50	12				3008-M2.5X6	80-T08	2508-M10x30
AHFM-LN0303-D063-A22-Z09-H	●	63	9	22	50	12						

R: Sağ / Right / Правый L: Sol / Left / Левый

● Stokta / In Stock / В наличии ○ Stokta Yok / Non Stock Item / Нет в наличии

TNGYL Ucuna Uygunur. / Compatiple with TNGYL Insert. / Под пластину KYCR

Sipariş Örneği/Ordering Example/ Bestellbeispiel

1 ad./pcs./шт. AHFM-L003-D040-A16-Z06-H

Kesme Hesabı : S 367 / Cutting Calculation : P 367 / Расчет режимов резания: стр. 367

Montaj Ölçüleri : S 364 / Mounting Reference : P 364 / Инструкция по установке фрез: стр. 364

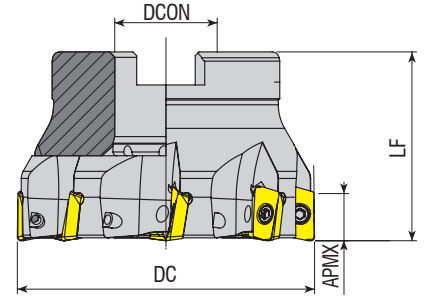

Takım Kodu Ordering Code Код для заказа	Stok Stock Наличие	Takım Ölçüleri (mm) Dimension (mm) Размеры (мм)					Kesici Uç Insert Пластина	Yedek Parçaları / Spare Parts / Запасные части			
		DC	ZEFP	DCON	LF	APMX		Sıkma Vidası Screw Зажимной винт	Tork Anahtar Torx Key Торк Ключ	Montaj Vidası Mounting Screw Монтажный винт	
AHFM-JD1003-D040-A16-Z06-H	●	40	6	16	40	9	JDMT 1003..		3008-M2.5x6		2506-M8x30
AHFM-JD1003-D063-A22-Z08-H	●	63	8	22	40	9					2508-M10x30

MTSBH Ucuna Uygunur. / Compatible with MTSBH Insert. / Под пластину MTSBH

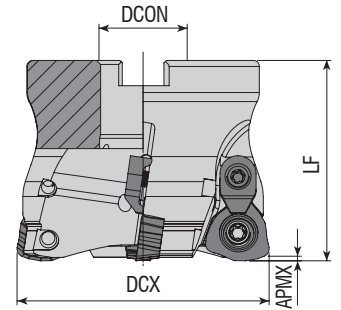

Takım Kodu Ordering Code Код для заказа	Stok Stock Наличие	Takım Ölçüleri (mm) Dimension (mm) Размеры (мм)					Kesici Uç Insert Пластина	Yedek Parçaları / Spare Parts / Запасные части				
		DCX	ZEFP	DCON	LF	APMX		Sıkma Vidası Screw Зажимной винт	Baskı Pabucu Wedge Clamp Прижим	Baskı Vidası Clamp Screw Зажимной винт	Tork Anahtar Torx Key Торк Ключ	Montaj Vidası Mounting Screw Монтажный винт
AHFMC-JD1204-D052-A22-Z03-H	●	52	3	22	50	1.5	JDMW 1204..					
AHFMC-JD1204-D052-A22-Z04-H	●	52	4	22	50	1.5						
AHFMC-JD1204-D063-A22-Z05-H	●	63	5	22	50	1.5						
AHFMC-JD1204-D080-A27-Z06-H	●	80	6	27	50	1.5						
AHFMC-JD1204-D100-A32-Z07-H	●	100	7	32	50	1.5						
AHFMC-JD1405-D052-A22-Z03-H	●	52	3	22	40	2						
AHFMC-JD1405-D063-A22-Z04-H	●	63	4	22	40	2	2508-M10x30					

R: Sağ / Right / Правый L: Sol / Left / Левый

● Stokta / In Stock / В наличии ○ Stokta Yok / Non Stock Item / Нет в наличии

MTSBH Ucuna Uygunur. / Compatible with MTSBH Insert. / Под пластину MTSBH

Sipariş Örneği/Ordering Example/Bestelbeispiel

1 ad./pcs./шт. AHFM-JD1003-D040-A16-Z06-H

Kesme Hesabı : S 367 / Cutting Calculation : P 367 / Расчет режимов резания: стр. 367

Montaj Ölçüleri : S 364 / Mounting Reference : P 364 / Инструкция по установке фрез: стр. 364

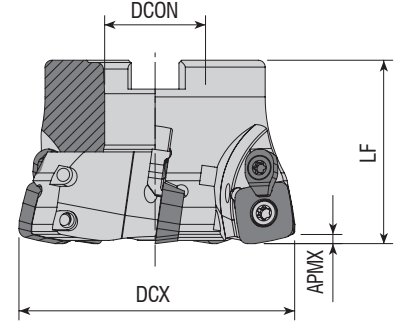

Takım Kodu Ordering Code Код для заказа	Stok Stock Наличие	Takım Ölçüleri (mm) Dimension (mm) Размеры (мм)					Kesici Uç Insert Пластина	Yedek Parçaları / Spare Parts / Запасные части				
		DCX	ZEFP	DCON	LF	APMX		Sıkma Vidası Screw Зажимной винт	Baskı Pabucu Wedge Clamp Прижим	Baskı Vidası Clamp Screw Зажимной винт	Tork Anahtar Torx Key Торх Ключ	Montaj Vidası Mounting Screw Монтажный винт
AHFMC-SD1204-D050-A22-Z04-H	●	50	4	22	40	1.8	SD.. 1204..	4015-M4x11	ACK-15	4015-M3.5x11	80-T15	2508-M10x30
AHFMC-SD1204-D063-A22-Z05-H	●	63	5	22	40	1.8						
AHFMC-SD1204-D080-A27-Z06-H	●	80	6	27	50	1.8						
AHFMC-SD1204-D100-A32-Z08-H	●	100	8	32	50	1.8						

ZCC Ucuna Uygun. / Compatible with ZCC Insert. / Под пластину HRN

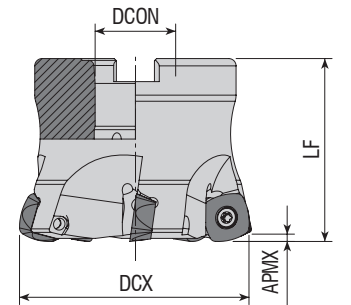
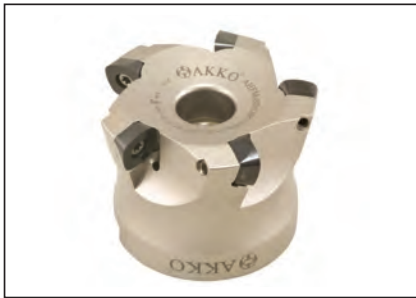

Takım Kodu Ordering Code Код для заказа	Stok Stock Наличие	Takım Ölçüleri (mm) Dimension (mm) Размеры (мм)					Kesici Uç Insert Пластина	Yedek Parçaları / Spare Parts / Запасные части		
		DCX	ZEFP	DCON	LF	APMX		Sıkma Vidası Screw Зажимной винт	Tork Anahtar Torx Key Торх Ключ	Montaj Vidası Mounting Screw Монтажный винт
AHFM-SD1205-D052-A22-Z04-H	●	52	4	22	50	2	SD.. 1205..	4015-M4x11	80-T15	2508-M10x30
AHFM-SD1205-D052-A22-Z05-H	●	52	5	22	50	2				
AHFM-SD1205-D066-A22-Z05-H	●	66	5	22	50	2				
AHFM-SD1205-D066-A22-Z06-H	●	66	6	22	50	2				
AHFM-SD1205-D080-A27-Z06-H	●	80	6	27	70	2				

R: Sağ / Right / Правый L: Sol / Left / Левый

● Stokta / In Stock / В наличии ○ Stokta Yok / Non Stock Item / Нет в наличии

HTCH Ucuna Uygun. / Compatible with HTCH Insert. / Под пластину HRN

Sipariş Örneği/Ordering Example/ Bestellbeispiel

1 ad./pcs./шт. AHFM-SD1204-D050-A22-Z04-H

Kesme Hesabı : S 367 / Cutting Calculation : P 367 / Расчет режимов резания: стр. 367

Montaj Ölçüleri : S 364 / Mounting Reference : P 364 / Инструкция по установке фрез: стр. 364

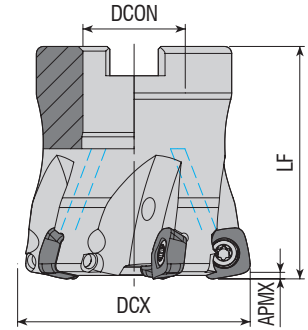

Takım Kodu Ordering Code Код для заказа	Stok Stock Наличие	Takım Ölçüleri (mm) Dimension (mm) Размеры (мм)					Kesici Uç Insert Пластина	Yedek Parçaları / Spare Parts / Запасные части		
		DCX	ZEFP	DCON	LF	APMX		Sıkma Vidası Screw Зажимной винт	Tork Anahtar Torx Key Торх Ключ	Montaj Vidası Mounting Screw Монтажный винт
AHFM-SO1004-D050-A22-Z05-H	●	50	5	22	50	1.5	SOMT 1004..	4015-M4x11	80-T15	2508-M10x30 2510-M12x35
AHFM-SO1004-D063-A22-Z06-H	●	63	6	22	50	1.5				
AHFM-SO1004-D080-A27-Z07-H	●	80	7	27	63	1.5				

KYCR Ucuna Uygunudur. / Compatible with KYCR Insert. / Под пластину KYCR

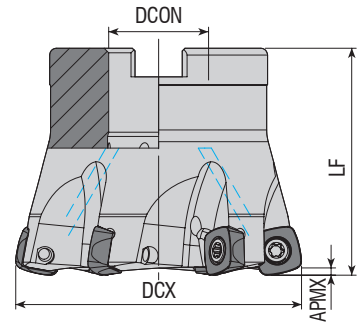

Takım Kodu Ordering Code Код для заказа	Stok Stock Наличие	Takım Ölçüleri (mm) Dimension (mm) Размеры (мм)					Kesici Uç Insert Пластина	Yedek Parçaları / Spare Parts / Запасные части		
		DCX	ZEFP	DCON	LF	APMX		Sıkma Vidası Screw Зажимной винт	Tork Anahtar Torx Key Торх Ключ	Montaj Vidası Mounting Screw Монтажный винт
AHFM-SP1004-D050-A22-Z05-H	●	50	5	22	50	1.5	SPNW 1004..	3015-M3.5x9	80-T15	2508-M10x30
AHFM-SP1004-D052-A22-Z05-H	●	52	5	22	50	1.5				
AHFM-SP1004-D063-A22-Z06-H	●	63	6	22	50	1.5				

R: Sağ / Right / Правый L: Sol / Left / Левый

● Stokta / In Stock / В наличии ○ Stokta Yok / Non Stock Item / Нет в наличии

DJT Ucuna Uygunudur. / Compatible with DJT Insert. / Под пластину DJT

Sipariş Örneği/Ordering Example/Bestellbeispiel

1 ad./pcs./шт. AHFM-SO1004-D050-A22-Z05-H

Kesme Hesabı : S 367 / Cutting Calculation : P 367 / Расчет режимов резания: стр. 367

Montaj Ölçüleri : S 364 / Mounting Reference : P 364 / Инструкция по установке фрез: стр. 364

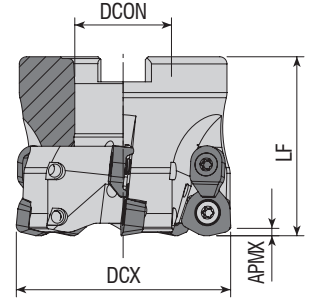

Takım Kodu Ordering Code Код для заказа	Stok Stock Наличие	Takım Ölçüleri (mm) Dimension (mm) Размеры (мм)					Kesici Uç Insert Пластина	Yedek Parçaları / Spare Parts / Запасные части				
		DCX	ZEFP	DCON	LF	APMX		Sıkma Vidası Screw Зажимной винт	Baskı Pabucu Wedge Clamp Прижим	Baskı Vidası Clamp Screw Зажимной винт	Tork Anahtar Torx Key Торх Ключ	Montaj Vidası Mounting Screw Монтажный винт
AHFMC-WD06T3D-D042-A16-Z04-H	●	42	4	16	45	1.5	WD.W 06T3..	3015-M3.5x9	ACK-15	4015-M3.5x11	80-T15	2506-M8x30
AHFMC-WD06T3D-D050-A22-Z05-H	●	50	5	22	50	1.5						
AHFMC-WD06T3D-D052-A22-Z05-H	●	52	5	22	50	1.5						
AHFMC-WD0805D-D052-A22-Z04-H	●	52	4	22	50	2	WD.W 0805..	4020-M4.5x12	ACK-19	4020-M4.5x12	80-T20	2508-M10x30
AHFMC-WD0805D-D063-A22-Z05-H	●	63	5	22	50	2						
AHFMC-WD0805D-D063-A27-Z05-H	●	63	5	27	50	2						
AHFMC-WD0805D-D066-A27-Z05-H	●	66	5	27	50	2						
AHFMC-WD0805D-D080-A27-Z05	●	80	5	27	50	2						
AHFMC-WD0805D-D100-A32-Z06	●	100	6	32	50	2						
AHFMC-WD10X6D-D125-B40-Z06	●	125	6	40	63	2.5	WD.W 10X6..					2510-M12x35
AHFMC-WD10X6D-D160-C40-Z07	●	160	7	40	63	2.5						

DJT Ucuna Uygunudur. / Compatible with DJT Insert. / Под пластину DJT

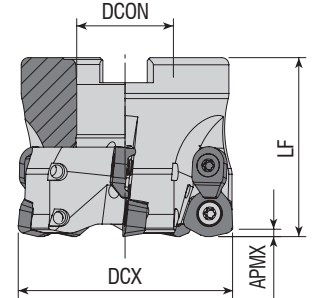

Takım Kodu Ordering Code Код для заказа	Stok Stock Наличие	Takım Ölçüleri (mm) Dimension (mm) Размеры (мм)					Kesici Uç Insert Пластина	Yedek Parçaları / Spare Parts / Запасные части				
		DCX	ZEFP	DCON	LF	APMX		Sıkma Vidası Screw Зажимной винт	Baskı Pabucu Wedge Clamp Прижим	Baskı Vidası Clamp Screw Зажимной винт	Tork Anahtar Torx Key Торх Ключ	Montaj Vidası Mounting Screw Монтажный винт
AHFMC-WD0804D-D040-A16-Z04-H	●	40	4	16	40	1.5	WDMT 0804..	4010-M3x8	ACK-15	4010-M3x8	80-T10	2506-M8x30
AHFMC-WD0804D-D050-A22-Z04-H	●	50	4	22	50	1.5						
AHFMC-WD1205-D050-A22-Z04-H	●	50	4	22	50	3	WDMT 1205..	1415-M4x11	ACK-05	4015-M4x11	80-T15	2508-M10x30
AHFMC-WD1205-D052-A22-Z04-H	●	52	4	22	50	3						
AHFMC-WD1205-D063-A22-Z05-H	●	63	5	22	50	3						
AHFMC-WD1205-D080-A27-Z06-H	●	80	6	27	63	3						

R: Sağ / Right / Правый L: Sol / Left / Левый

● Stokta / In Stock / В наличии ○ Stokta Yok / Non Stock Item / Нет в наличии

SMTM Ucuna Uygunudur. / Compatible with SMTM Insert. / Под пластину SMTM

Sipariş Örneği/Ordering Example/Bestellbeispiel

1 ad./pcs./шт. AHFMC-WD06T3D-D042-A16-Z04-H

Kesme Hesabı : S 367 / Cutting Calculation : P 367 / Расчет режимов резания: стр. 367

Montaj Ölçüleri : S 364 / Mounting Reference : P 364 / Инструкция по установке фрез: стр. 364

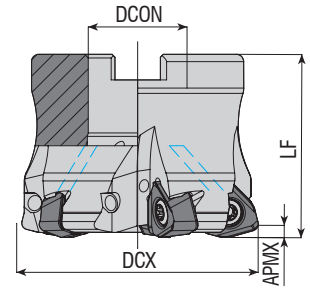

Takım Kodu Ordering Code Код для заказа	Stok Stock Наличие	Takım Ölçüleri (mm) Dimension (mm) Размеры (мм)					Kesici Uç Insert Пластина	Yedek Parçaları / Spare Parts / Запасные части			
		DCX	ZEFP	DCON	Lf	APMX		Sıkma Vidası Screw Зажимной винт	Tork Anahtar Torx Key Торх Ключ	Montaj Vidası Mounting Screw Монтажный винт	
AHFM-WN0907-D050-A22-Z04-H	●	50	4	22	50	3	WNUMU 0907..	1020-M5x14	80-T20	2508-M10x30	
AHFM-WN0907-D052-A22-Z04-H	●	52	4	22	50	3					
AHFM-WN0907-D063-A22-Z05-H	●	63	5	22	50	3					
AHFM-WN0907-D066-A27-Z05-H	●	66	5	27	50	3					
AHFM-WN0907-D080-A27-Z06-H	●	80	6	27	50	3					
AHFM-WN0907-D100-A32-Z07-H	●	100	7	32	50	3					

DJT Ucuna Uygundur. / Compatible with DJT Insert. / Под пластину DJT

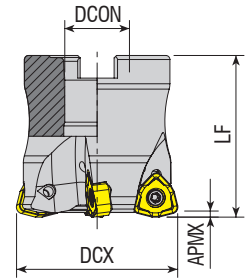

Takım Kodu Ordering Code Код для заказа	Stok Stock Наличие	Takım Ölçüleri (mm) Dimension (mm) Размеры (мм)					Kesici Uç Insert Пластина	Yedek Parçaları / Spare Parts / Запасные части			
		DCX	ZEFP	DCON	Lf	APMX		Sıkma Vidası Screw Зажимной винт	Tork Anahtar Torx Key Торх Ключ	Montaj Vidası Mounting Screw Монтажный винт	
AHFM-WN09T3-D040-A16-Z04-H	●	40	4	16	40	1.5	WNUMX 09T3..	4010-M3x8	80-T10	2506-M8x30	
AHFML-WN09T3-D040-A16-Z04-H	●	40	4	16	40	1.5					
AHFM-WN09T3-D050-A22-Z05-H	●	50	5	22	40	1.5					
AHFML-WN09T3-D050-A22-Z05-H	●	50	5	22	40	1.5					
AHFM-WN09T3-D063-A22-Z06-H	●	63	6	22	40	1.5					

R: Sağ / Right / Правый L: Sol / Left / Левый

● Stokta / In Stock / В наличии ○ Stokta Yok / Non Stock Item / Нет в наличии
KRLY Ucuna Uygundur. / Compatible with KRLY Insert. / Под пластину KRLY

Sipariş Örneği/Ordering Example/Bestellbeispiel
1 ad./pcs./шт. AHFM-WN0907-D050-A22-Z04-H

Kesme Hesabı : S 367 / Cutting Calculation : P 367 / Расчет режимов резания: стр. 367
Montaj Ölçüleri : S 364 / Mounting Reference : P 364 / Инструкция по установке фрез: стр. 364

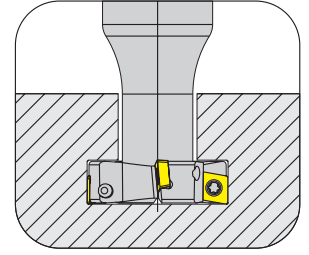
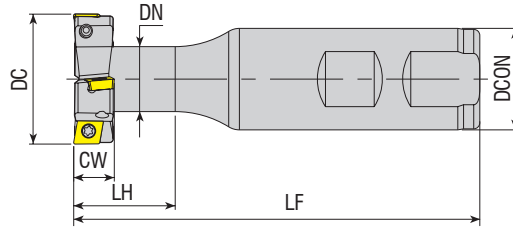

Takım Kodu
Ordering Code
Код для заказа

Stok
Stock
Наличие

ZEPF
Toplam
Total
Gesamt

Etkili
Effective
Effektiv

DC CW DCON LF DN LH

Takım Ölçüleri (mm)
Dimension (mm)
Размеры (мм)

Kesici Uç
Insert
Пластина

Yedek Parçaları / Spare Parts / Запасные части

Sıkma Vidası
Screw
Зажимной винт

Tork Anahtar
Torx Key
Торх Ключ

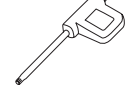

ATSM90-CC06-D17X8-W16-L85-Z02	●	2	1	17	8	16	85	10	16	CC.T 0602..	3008-M2.5x6	80-T08
ATSM90-CC06-D32X8-W25-L100-Z04	●	4	2	32	8	25	100	16	23			
ATSM90-CC06-D28X8-W20-L66-Z04	●	4	2	28	8	20	66	14	15.5			
ATSM90-CC06-D45.5X8-W25-L100-Z06	●	6	3	45.5	8	25	100	12	30			
ATSM90-CC06-D63X8-W32-L125-Z08	●	8	4	63	8	32	125	31.5	30			
ATSM90-CC06-D18X9-W16-L90-Z02	●	2	1	18	9	16	90	10	16			
ATSM90-CC06-D20X9-W16-L85-Z04	●	4	2	20	9	16	85	10	16			
ATSM90-CC06-D23X10-W20-L90-Z04	●	4	2	23	10	20	90	12	25			
ATSM90-CC06-D32X10-W25-L100-Z04	●	4	2	32	10	25	100	16	25			
ATSM90-CC06-D45X10-W32-L120-Z06	●	6	3	45	10	32	120	20	25			
ATSM90-CC06-D25X11-W25-L100-Z04	●	4	2	25	11	25	100	13	20	CC.T. 09T3..	4015-M3.5x9	80-T15
ATSM90-CC09-D30X12-W25-L100-Z04	●	4	2	30	12	25	100	16	25			
ATSM90-CC09-D32X12-W25-L100-Z02	●	2	1	32	12	25	100	16	25			
ATSM90-CC09-D32X12-W25-L100-Z04	●	4	2	32	12	25	100	16	25			
ATSM90-CC09-D32X14-W25-L100-Z04	●	4	2	32	14	25	100	16	25			
ATSM90-CC09-D37X16-W32-L120-Z04	●	4	2	37	16	32	120	17	30			
ATSM90-CC09-D40X17-W32-L120-Z04-H	●	4	2	40	17	32	120	19	30			
ATSM90-CC09-D42X17-W32-L120-Z04	●	4	2	42	17	32	120	19	30			
ATSM90-CC12-D47X20-W32-L120-Z04	●	4	2	47	20	32	120	25	45			
ATSM90-CC12-D52X21-W32-L120-Z04	●	4	2	52	21	32	120	25	45			
ATSM90-CC12-D50X22-W32-L120-Z04	●	4	2	50	22	32	120	25	45	CC.T 1204..	1020-M5x11	80-T20
ATSM90-CC12-D55X22-W32-L120-Z04	●	4	2	55	22	32	120	25	45			

R: Sağ / Right / Правый L: Sol / Left / Левый

● Stokta / In Stock / В наличии ○ Stokta Yok / Non Stock Item / Нет в наличии

Sipariş Örneği/Ordering Example/Bestellbeispiel

1 ad./pcs./шт. ATSM90-CC06-D17X8-W16-L85-Z02

Kesme Hesabı : S 367 / Cutting Calculation : P 367 / Расчет режимов резания: стр. 367



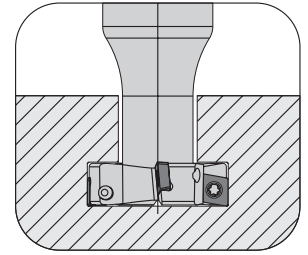
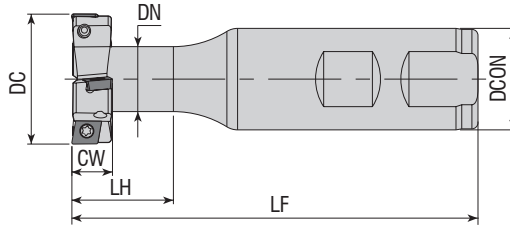

Takım Kodu
Ordering Code
Код для заказа

	Stok Stock Наличие	Takım Ölçüleri (mm) Dimension (mm) Размеры (мм)							Kesici Uç Insert Пластина	Yedek Parçaları / Spare Parts / Запасные части		
		ZEFP		DC	CW	DCON	LF	DN		LH	Sıkma Vidası Screw Зажимной винт	Tork Anahtar Torx Key Торх Ключ
		Toplam Total Gesamt	Etkili Effective Effektiv									
ATSM90-SP..05-D22.5X5-W25-L100-Z04	●	4	2	22.5	5	25	100	12	25	SPMG 050204 TGTC UCUNA UYGUNDUR. FOR TGTC INSERT. Подпластину TGTC	3006-M2x4	80-T06
ATSM90-SP..05-D30X5-W25-L100-Z04	●	4	2	30	5	25	100	10	25			
ATSM90-SPGT0502-D63X6-W32-L125-Z10	●	10	5	63	6	32	125	31	30	SPGT 050204	4015-M3.5x9	80-T15
ATSM90-SPGT0904-D32X14-W32-L120-Z04-H	●	4	2	32	14	32	120	17.5	30	SPGT 090408 ZCC UCUNA UYGUNDUR. FOR ZCC INSERT. Подпластину ZCC		
ATSM90-SPGT0904-D37X16-W32-L120-Z04-H	●	4	2	37	16	32	120	21	40	SPGT 110408	4015-M4x11	80-T07
ATSM90-SPGT0904-D42X17-W32-L120-Z04-H	●	4	2	42	17	32	120	21	40			
ATSM90-SPGT1104-D47X20-W32-L120-Z04-H	●	4	2	47	20	32	120	24	45	SPMG 060204 TGTC UCUNA UYGUNDUR. FOR TGTC INSERT. Подпластину TGTC	3007-M2.2x5	80-T07
ATSM90-SP..06-D80X7-W32-L120-Z10	●	10	5	80	7	32	120	32	30			

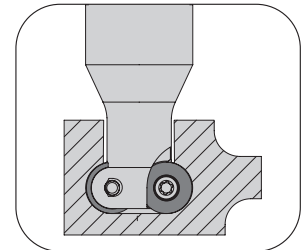
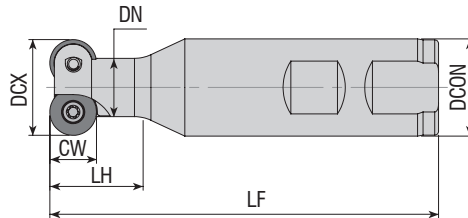

Takım Kodu
Ordering Code
Код для заказа

	Stok Stock Наличие	Takım Ölçüleri (mm) Dimension (mm) Размеры (мм)							Kesici Uç Insert Пластина	Yedek Parçaları / Spare Parts / Запасные части	
		ZEFP	DCX	CW	DCON	LF	DN	LH		Sıkma Vidası Screw Зажимной винт	Tork Anahtar Torx Key Торх Ключ
ATSMR-RD0702-D17-W16-L90-Z02	●	2	17	7	16	90	10	12	RD.. 0702	3008-M2.5x6	80-T08
ATSMR-RD0702-D25-W16-L90-Z03	●	3	25	7	16	90	15	12			
ATSMR-RD0702-D35-W25-L100-Z05	●	5	35	7	25	100	20	20	RD.. 1003	4015-M3.5x9	80-T15
ATSMR-RD1003-D21-W25-L100-Z02	●	2	21	10	25	100	12	20			
ATSMR-RD1003-D80-W32-L165-Z06-H	●	6	80	10	32	165	30	31.5	RD.. 12T3	4015-M4.5x11	80-T15
ATSMR-RD12T3-D25-W25-L100-Z02	●	2	25	12	25	100	15	24			
ATSMR-RD12T3-D80-W32-L165-Z06-H	●	6	80	12	32	165	30	31.5	RD.. 1604	4015-M4.5x11	80-T15
ATSMR-RD1604-D34-W32-L110-Z02	●	2	34	16	32	110	20	30			

R: Sağ / Right / Правый L: Sol / Left / Левый

● Stokta / In Stock / В наличии ○ Stokta Yok / Non Stock Item / Нет в наличии

ISO Ucuna Uygundur. / Compatiple with ISO Insert. / Под пластину ISO

Sipariş Örneği/Ordering Example/Bestellbeispiel

1 ad./pcs./шт. ATSM90-SP.05-D22.5X5-W25-L100-Z04

Kesme Hesabı : S 367 / Cutting Calculation : P 367 / Расчет режимов резания: стр. 367

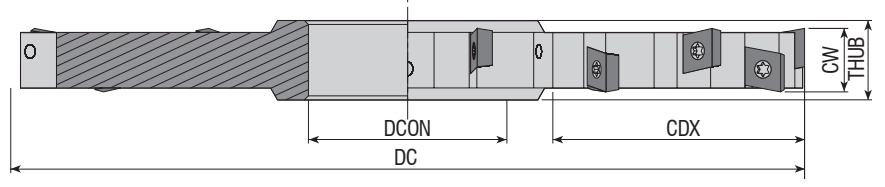

Takım Kodu Ordering Code Код для заказа	Stok Stock Наличие	Takım Ölçüleri (mm) Dimension (mm) Размеры (мм)							Kesici Uç Insert Пластина	Yedek Parçaları / Spare Parts / Запасные части		
		ZEFP		DC	CW	CDX	DCON	THUB		Sıkma Vidası Screw Зажимной винт	Tork Anahtar Torx Key Торх Ключ	
		Toplam Total Gesamt	Etkili Effective Efektiv									
ASDM-SPGT05-D80x6-d27-Z10	●	10	5	80	6	17	27	10	SPGT 050204 ZCC UCUNA UYGUNDUR. FOR ZCC INSERT. Под пластину ZCC	3006-M2x4	80-T06	
ASDM-SPGT05-D100x6-d32-Z12	●	12	6	100	6	25	32	10				
ASDM-SPGT05-D125x6-d40-Z14	●	14	7	125	6	35	40	10				
ASDM-SPGT05-D160x6-d40-Z18	●	18	9	160	6	52	40	10				
ASDM-SPGT06-D80x7-d27-Z10	●	10	5	80	7	17	27	11	SPGT 060204 ZCC UCUNA UYGUNDUR. FOR ZCC INSERT. Под пластину ZCC	3007-M2.2x5	80-T07	
ASDM-SPGT06-D100x7-d32-Z12	●	12	6	100	7	25	32	11				
ASDM-SPGT06-D125x7-d40-Z14	●	14	7	125	7	35	40	11				
ASDM-SPGT06-D160x7-d40-Z16	●	16	8	160	7	52	40	11				
ASDM-SPGT06-D200x7-d40-Z18	●	18	9	200	7	70	40	11	SPGT 07T308	3008-M2.5x6	80-T08	
ASDM-SPGT07-D100x10-d32-Z12	●	12	6	100	10	25	32	11				

R: Sağ / Right / Правый L: Sol / Left / Левый
 ● Stokta / In Stock / В наличии ○ Stokta Yok / Non Stock Item / Нет в наличии

Sipariş Örneği/Ordering Example/Bestellbeispiel
 1 ad./pcs./шт. ASDM-SPGT05-D80x6-d27-Z10
 Kesme Hesabı : S 367 / Cutting Calculation : P 367 / Расчет режимов резания: стр. 367



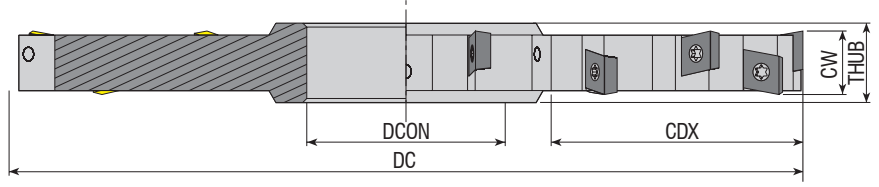

Takım Kodu
Ordering Code
Код для заказа

Stok
Stock
Наличие

Takım Ölçüleri (mm)
Dimension (mm)
Размеры (мм)

Kesici Uç
Insert
Пластина

Yedek Parçaları / Spare Parts / Запасные части

Sıkma Vidası
Screw
Зажимной винт

Tork Anahtar
Torx Key
Торх Ключ

ZEPF
Toplam
Total
Gesamt

Etkili
Effective
Effektiv

DC

CW

CDX

DCON

THUB



ASDM-CC06-D80x8-d27-Z10	●	10	5	80	8	17	27	12	CC.T 0602.. ISO UCUNA UYGUNDUR. FOR ISO INSERT. Под пластину ISO	3008-M2.5x6	80-T08
ASDM-CC06-D100x8-d32-Z12	●	12	6	100	8	25	32	12			
ASDM-CC06-D125x8-d40-Z14	●	14	7	125	8	35	40	12			
ASDM-CC06-D160x8-d40-Z16	●	16	8	160	8	52	40	12			
ASDM-CC06-D200x8-d40-Z18	●	18	9	200	8	70	40	12			
ASDM-CC06-D80x10-d27-Z10	●	10	5	80	10	17	27	14			
ASDM-CC06-D100x10-d32-Z12	●	12	6	100	10	25	32	14			
ASDM-CC06-D125x10-d40-Z14	●	14	7	125	10	35	40	14			
ASDM-CC06-D160x10-d40-Z16	●	16	8	160	10	52	40	14			
ASDM-CC06-D200x10-d40-Z18	●	18	9	200	10	70	40	14			
ASDM-CC09-D80x12-d27-Z08	●	8	4	80	12	17	27	16	CC.T 09T3.. ISO UCUNA UYGUNDUR. FOR ISO INSERT. Под пластину ISO	4015-M3.5x11	80-T15
ASDM-CC09-D100x12-d32-Z10	●	10	5	100	12	25	32	16			
ASDM-CC09-D125x12-d40-Z12	●	12	6	125	12	35	40	16			
ASDM-CC09-D160x12-d40-Z14	●	14	7	160	12	52	40	16			
ASDM-CC09-D200x12-d40-Z16	●	16	8	200	12	70	40	16			
ASDM-CC09-D80x14-d27-Z08	●	8	4	80	14	17	27	18			
ASDM-CC09-D100x14-d32-Z10	●	10	5	100	14	25	32	18			
ASDM-CC09-D125x14-d40-Z12	●	12	6	125	14	35	40	18			
ASDM-CC09-D160x14-d40-Z14	●	14	7	160	14	52	40	18			
ASDM-CC09-D200x14-d40-Z16	●	16	8	200	14	70	40	18			
ASDM-CC12-D80x16-d27-Z06	●	6	3	80	16	17	27	20	CC.T 1204.. ISO UCUNA UYGUNDUR. FOR ISO INSERT. Под пластину ISO	1020-M5x11	80-T20
ASDM-CC12-D100x16-d32-Z08	●	8	4	100	16	25	32	20			
ASDM-CC12-D125x16-d40-Z10	●	10	5	125	16	35	40	20			
ASDM-CC12-D160x16-d40-Z12	●	12	6	160	16	52	40	20			
ASDM-CC12-D200x16-d40-Z14	●	14	7	200	16	70	40	20			
ASDM-CC12-D80x18-d27-Z06	●	6	3	80	18	17	27	22			
ASDM-CC12-D100x18-d32-Z08	●	8	4	100	18	25	32	22			
ASDM-CC12-D125x18-d40-Z10	●	10	5	125	18	35	40	22			
ASDM-CC12-D160x18-d40-Z12	●	12	6	160	18	52	40	22			
ASDM-CC12-D200x18-d40-Z14	●	14	7	200	18	70	40	22			
ASDM-CC12-D250x18-d40-Z16	●	16	8	250	18	90	40	22			
ASDM-CC12-D80x20-d27-Z06	●	6	3	80	20	17	27	24			
ASDM-CC12-D100x20-d32-Z08	●	8	4	100	20	25	32	24			
ASDM-CC12-D125x20-d40-Z10	●	10	5	125	20	35	40	24			
ASDM-CC12-D160x20-d40-Z12	●	12	6	160	20	52	40	24			
ASDM-CC12-D200x20-d40-Z14	●	14	7	200	20	70	40	24			
ASDM-CC12-D250x20-d40-Z16	●	16	8	250	20	90	40	24			

R: Sağ / Right / Правый L: Sol / Left / Левый

● Stokta / In Stock / В наличии ○ Stokta Yok / Non Stock Item / Нет в наличии

Sipariş Örneği/Ordering Example/Bestellbeispiel

1 ad./pcs./шт. ASDM-CC06-D80x8-d27-Z10

Kesme Hesabı : S 367 / Cutting Calculation : P 367 / Расчет режимов резания: стр. 367

A TİP / A TYPE / A Тип

DC	DCON	DBC	KWW	L8	CBDP
40	16	-	8.4	5.6	20
50	22	-	10.4	6.3	22
63	22	-	10.4	6.3	22
80	27	-	12.4	7	25
100	32	-	14.4	8	26

B TİP / B TYPE / B Тип

DC	DCON	DBC	KWW	L8	CBDP
125	40	-	16.4	9	32

C TİP / C TYPE / C Тип

DC	DCON	DBC	KWW	L8	CBDP
160	40	66.7	16.4	9	32
200	60	101.6	25.7	14	40
250	60	101.6	25.7	14	40

D TİP / D TYPE / D Тип

DC	DCON	DBC	KWW	L8	CBDP
315	60	101.6	25.7	14	40

TAKMA UÇLU MATKAP (U-DRILL) KULLANMA KILAVUZU

Matkabınızı CNC torna tezgahına bağlamadan önce taretin merkezden kaçık olup olmadığını kontrol etmeniz gerekir. Şayet taretinizde kaçıklık varsa, takma uçlu matkabınızı kesinlikle kullanmayınız. Taretin düzeltilmesi için yapılması gereken işlemler ;

1. Taretin tutucusuna kullanacağınız takma uçlu matkabın çapında ve boyunda üzeri hassas olan silindirik bir parça bağlanır ve tezgahın X değeri sıfıra getirilir.
2. Tezgahın aynasına miknatıslı komprotör saati yerleştirilir. Saatin uç kısmı tarete bağlanmış olduğumuz parçanın üstüne temas ettirilir.
3. Aynanın üzerine bağlanmış olduğumuz miknatıslı komprotör ayna ile beraber 360 derece döndürülerek saatteki değişim oranına göre taretin sıfırlanması sağlanır.

TAKMA UÇLU MATKABINIZI CNC TORNANIZDA DAHA VERİMLİ KULLANMANIZ İÇİN GEREKLİ OLAN KESME HIZLARI ve DEVİRLERİ :

Grup No.	Malzemenin Cinsi	Malzemenin Öz.	Kesme Hızı Vc (m/dk)
1	Çok Yumuşak İş Çelikleri	C1010, Otomat vb.	220
2	İmalat Çelik ve Döküm Malz.	C1030 - 106 vb.	200
3	Takım ve İmalat Çeşitleri	CK-45, 4140, 7131 vb.	170
4	Sıcak İş ve Paslanmaz Çelikler	İmpaks vb.	150

Devir hesabı yapabilmek için önce malzemeyi seçiniz. Seçtiğiniz malzemenin kesme hızını (Vc) 1000 ile çarpıp 3.14'e bölmeliyiz. Çıkan değeri matkap çapına bölmeliyiz. **ÖRNEK** : Malzememiz takım ve imalat çeliği (3. grup), matkap çapı 25 mm kesme hızı 170 ise $170 \times 1000 = 170000 / 3.14 = 54140$, $54140 / 25 = 2166$ devir çıkar (Tezgahın İş Mili Devri). Tezgahın ilerlemesi kullanacağınız uç ile de alakalı olup 0.05 ile 0.10 arasında değişim gösterir. Kullanıcı kesici ucun kesişine göre bunu ayarlar.

İŞLEME MERKEZLERİ İÇİN İLERLEME HESABI :

Yukarıdaki hesaplamalarla bulmuş olduğunuz 2166 iş mili devrini, kesici uç ilerlemesi (mm/devir) 0.05 ile 0.10 arasındaki ilerleme seçenekleri ile çarpılır. **ÖRNEK 1** : $2166 \times 0.05 = 108$ **ÖRNEK 2** : $2116 \times 0.10 = 217$ çıkan sonuçlar 108 ve 217 işleme merkezleri için ilerleme mm/dakika hesabıdır.

Not: D4 ve üzeri takma uçlu matkaplarda tezgahın içten su verme basıncının en az 6 bar olması gerekmektedir.

USER'S GUIDE FOR AKKO U-DRILLS

Before connecting your U-Drill to CNC lathe, you have to check if the turret is eccentric from the center or not. If there is any eccentricity in your turret, never use your U-Drill;

Processes that should be done to fix the turret :

1. A cylindrical part whose surface is precision and whose length and diameter is the same with the U-Drill that you will use, should be mounted to the holder of turret and X value of the lathe should be brought to zero (0).
2. Comparator should be mounted to chuck. The end of the comparator should be contacted (touched) to the surface of the part that we mounted on the turret.
3. The comparator that we mounted on the chuck should be turned 360-degree with the chuck and turret should be zeroed by that turning according to changing rate of comparator.

CUTTING SPEED AND REVOLUTION THAT ARE NEEDED FOR USING (RUNNING) YOUR U-DRILLS MORE PRODUCTIVELY

Grup No.	Material	Material Type	Cutting Speed Vc (m/m)
1	Non-alloy steel and free cutting steel	C1010. Automat etc.	220
2	Low alloy steel and cast steel	C1030 - 106 etc.	200
3	Alloy steel and tool steel	CK-45, 4140, 7131 etc.	170
4	Hot Work Steel and Stainless Steel	Impax etc.	150

P.S. : The cutting speed may be concerned with the type of the insert that you use.

Fistly, choose the material to make calculation of revolution. You should multiply the cutting speed (Vc) of the material that you chose by 1000 and divide by 3.14. You should divide the value that you found by the diameter of U-Drill. For Example : If our material is alloy steel and tool steel (3rd group), diameter of the U-Drill is 25 mm, cutting speed is 170, we should calculate as following; $170 \times 1000 = 170000 / 3.14 = 54140$, $54140 / 25 = 2166$ rpm is the result that we found (Spindle Speed) Feed rate of the lathe is concerned with the U-Drill that you will use and changes between 0.05 and 0.10. The user sets it according to cut of cutting insert.

FEED CALCULATION FOR CENTRAL MACHINE :

2166 spindle speed, that we found as a result of above mentioned calculation, should be multiplied by cutting insert feed (mm/r) between 0.05 and 0.10 feed choisses. Example 1 : $2166 \times 0.05 = 108$

Example 2 : $2116 \times 0.10 = 217$ The results 108 and 217 are the feed mm/m calculation for central machine.

Note: Cooling water pressure of lathe must be minimum 6 bar for our D4 u-drills and u-drills longer than D4.

РУКОВОДСТВО ПО ЭКСПЛУАТАЦИИ СВЕРЕЛ

Перед началом работы на токарном станке не обходимо убедиться в расположении оси центров револьверной головки.

1. Установить позицию револьверной головки, в которую предполагается закрепить сверло и вывести по оси X в нулевое положение.
2. Обкатать индикатором часового типа посадочное отверстие резцедержателя или контрольной оправки зажатой в резцедержатель.
3. Проверните шпиндель на полный оборот. При необходимости отрегулируйте положение револьверной головки.

РЕЖИМЫ РЕЗАНИЕ

№	Материал	Марка	Скорость резания Vc (м/мин)
1	Нелегированная сталь и быстрорежущая сталь	C1010. Automat и т.д.	220
2	Низколегированная сталь и литая сталь	C1030 - 106 vb.	200
3	Инструментальная и легированная стал	CK-45, 4140, 7131 vb.	170
4	Закаленная и нержавеющая сталь	Imрах и т.д.	150

П.С.: скорость резания зависит от материала режущей пластины. Сначала выбирают скорость резания и рассчитывают обороты шпинделя по формуле $S=(1000 \times Vc)/(\pi \times \varnothing D)$, об/мин.

Например: если планируется сверление $\varnothing 25$ в легированной стали, то следует выбрать стартовую скорость резания 170 м/мин. Следовательно $S=(1000 \times 170)/(3.14 \times 25)=2166$ об/мин.

Подачу следует выбрать согласно рекомендаций производителя пластин обычно для сверла диаметром она варьируется в диапазоне $S=0,05...0,10$ мм/об.

РАСЧЕТ ПОДАЧИ:

Вторым этапом для ранее рассчитанной частоте вращения шпинделя назначается подача на оборот и рассчитывается минутная подача $F=S \times fz$, мм/мин. Пример, $F_{min}=2166 \text{ об/мин} \times 0,05 \text{ мм/об}=108,3 \text{ мм/мин}$; $F_{max}=2166 \text{ об/мин} \times 0,10 \text{ мм/об}=216,6 \text{ мм/мин}$ Примечание: при глубине сверления свыше $4D$ давление СОЖ должно превышать 6 бар.

SIKMA TORKU TAVSİYELERİ - RECOMMENDED TIGHTENING TORQUE

Рекомендуемый момент затяжки

- Takımı Sıkmadan Önce Aşağıdaki Bilgileri Okuyunuz.
Read below information before tightening the tool.
Прочтите нижеследующую информацию, прежде чем затягивать инструмент
- Vidalı Takımın Vida Ölçüsü ile Tutucunun İç Vida Ölçüsünü Sıkmadan Önce Kontrol Ediniz.
Check screw set's the screw size and together with mounting arbor inner dimension of screws.
Проверьте совпадают ли размеры резьбы фрезерной головки и оправки
- Takımı Tutucuya Sıkarken Tablodaki İlgili Değerlere Göre İşlem Yapınız.
When tightening head to an arbor, follow the related tightening torque in the table.
При затягивании фрезерной головки в оправке, следуйте значениям крутящего момента в таблице ниже

Vida Screw Резьба	Tork Torque (N.m) Крутящий момент (Н·м)
M6	8
M8	23
M10	46
M12	80
M16	90



FREZELEME İŞLEMİNDE DEVİR ve İLERLEME HESABI

Vc.	S	D	F	Z	fz	FORMÜLLER
Kesme Hızı (Uç Kutusunun Arkasından Okuyunuz)	İş Mili Devir Sayısı	Tarama Kafası Çapı	İlerleme	Tarama Kafası Ağız Sayısı	Diş Başına Düşen İlerleme Miktarı (Uç Kutusunun Arkasından Okuyunuz)	Devir Hesabı : $S=(Vc \times 1000) / (3,14 \times D)$ İlerleme Hesabı : $F=S \times Z \times fz$

Örnek : D=50 mm çapında, Z=5 ağızlı tarama kafası ile frezeleme yapacağız. Kesici uç kutusunun arkasında kesme hızı Vc=200m/dk. olarak verilmiş olsun. Tezgaha girilecek devri hesaplayalım: **Vc=200 m/dk. D=50 mm S =** Öncelikle Kesme Hızı 1000 ile çarpılır, çıkan sonuç 3,14 sayısına bölünür, buradan çıkan sonuç da tarama kafası çapına bölünür.

$S=200 \times 1000 = 200000 \rightarrow 200000/3,14=63663 \rightarrow 63663/50=1273$ devir **S=1273 dev/dakika** devri bulduktan sonra ilerlemeyi bulalım: **Z=5** ağızlı tarama kafası olsun **fz=0,12** olarak uç kutusunun arkasından okunmuş olsun F= yukarıda bulmuş olduğumuz devir sayısı ile ağız sayısı çarpılır, çıkan sonuç diş başına düşen ilerleme miktarı ile çarpılır.

$F=1273 \times 5 = 6365 \rightarrow 6365 \times 0,12 = 763$ $F=763$ mm/dakika

Tezgaha girilecek olan devir = S 1273 Tezgaha girilecek olan ilerleme : **F 763 ortalama değerdir.**

Not: Vc ve fz değerlerinin uç kutusunun arkasında verilmiş olması gerekir. Eğer bu değerler uç kutusunun üzerinde yoksa, kesici ucun katalogundan bulunuz. İşleyeceğiniz malzeme çelik ise P, paslanmaz çelik ise M, dökme demir ise K bölümünde yazılı olan Vc ve fz değerlerini okuyun.

CALCULATING SPINDLE SPEED and FEED RATE FOR MILLING PROCESS

Vc.	S	D	F	Z	fz	FORMULAS
Cutting Speed (Please read from the back- side of cutting insert box)	Spindle Revolution rpm	Milling Tool Diameter	Feed Rate	Number of Effective Tooth	Feed Per Tooth (Please Read From The Back Side of Cutting Insert Box)	Calculation of Revolution : $S=(Vc \times 1000) / (3,14 \times D)$ Feed Rate Calculation : $F=S \times Z \times fz$

For Example : We will make milling with milling tool whose diameter is D 50 mm, whose teeth number is Z=5. The spindle revolution was written as Vc=200m/mn at the back side of cutting insert box. Let's calculate the revolution that should be entered to the milling machine : Vc=200 m/mn D=50 mm
S = Firstly Cutting Speed is multiplied with 1000, the result should be divided by 3.14 , the last result should be divided by diameter of milling tool.

$S = 200 \times 1000 = 200000 \rightarrow 200000/3,14 = 63663 \rightarrow 63663/50 = 1273$ rev $S=1273$ rev / mn

After finding spindle revolution, let's find feed rate : milling tool with Z=5 teeth and we read fz=0,12 from the back side of cutting insert box.

F = Tooth number should be multiplied with revolution, the result should be multiplied with feed per tooth.

$F = 1273 \times 5 = 6365 \rightarrow 6365 \times 0,12 = 763$ $F = 763$ mm / mn

Revolution that should be entered to the milling machine = S 1273 Feed Rate that should be entered to the milling machine = F 763 average value.

P.S : The values Vc and fz has to be written at the back side of the cutting insert. If these values were not written on the cutting insert box, please find them from cutting insert catalogue. If the material that you will work is steel, please read Vc and fz values that were written on the part P, if it is stainless steel please read from the part M, if it is cast iron please read from the part K.

РАСЧЕТ СКОРОСТИ ВРАЩЕНИЯ ШПИНДЕЛЯ И ПОДАЧИ ДЛЯ ФРЕЗЕРОВАНИЯ

Vc.	S	D	F	Z	fz	Formeln
Скорость резания (Пожалуйста прочитайте на обратной стороне упаковки пластины)	Частота вращения шпинделя (мм/об*мин)	Диаметр фрезы	Скорость подачи	Число эффективных зубьев	Подача на зуб (Пожалуйста прочитайте на обратной стороне упаковки пластины)	Расчет частоты вращения шпинделя: $S=(Vc \times 1000) / (3,14 \times D)$ Расчет скорости подачи: $F=S \times Z \times fz$

Например, для фрезы $\varnothing 50$ с числом зубьев 5. Для выбранной СМП рекомендуемые Vc=200 м/мин; fz=0,12м/мин. Обороты шпинделя $S=(1000 \times Vc)/(\pi \times \varnothing D)=(1000 \times 200)/(3,1416 \times 50)=1273$ об/мин. Минутная подача $F=S \times fz \times Z=1273 \times 0,12 \times 5=763$ мм/мин.

П.С.: Более точные рекомендации по стартовым скоростям резания Vc и fz можно найти в каталоге производителя СМП. Базовые значения обычно указаны на оборотной стороне коробки СМП. Обработываемые материалы зашифрованы буквенно-цветовой маркировкой по ИСО513: P - сталь; M - нерж. стали, K-чугуны, N-цв. сплавы, S-жаропрочные стали, H - закалённые стали.

Gövde Malzemesine Göre Delik İçi Kater Uygulama Kılavuzu

Internal Boring Bars Application Guide, Related to Body Material

Рекомендации по выбору материала хвостовика резца в зависимости от вылета

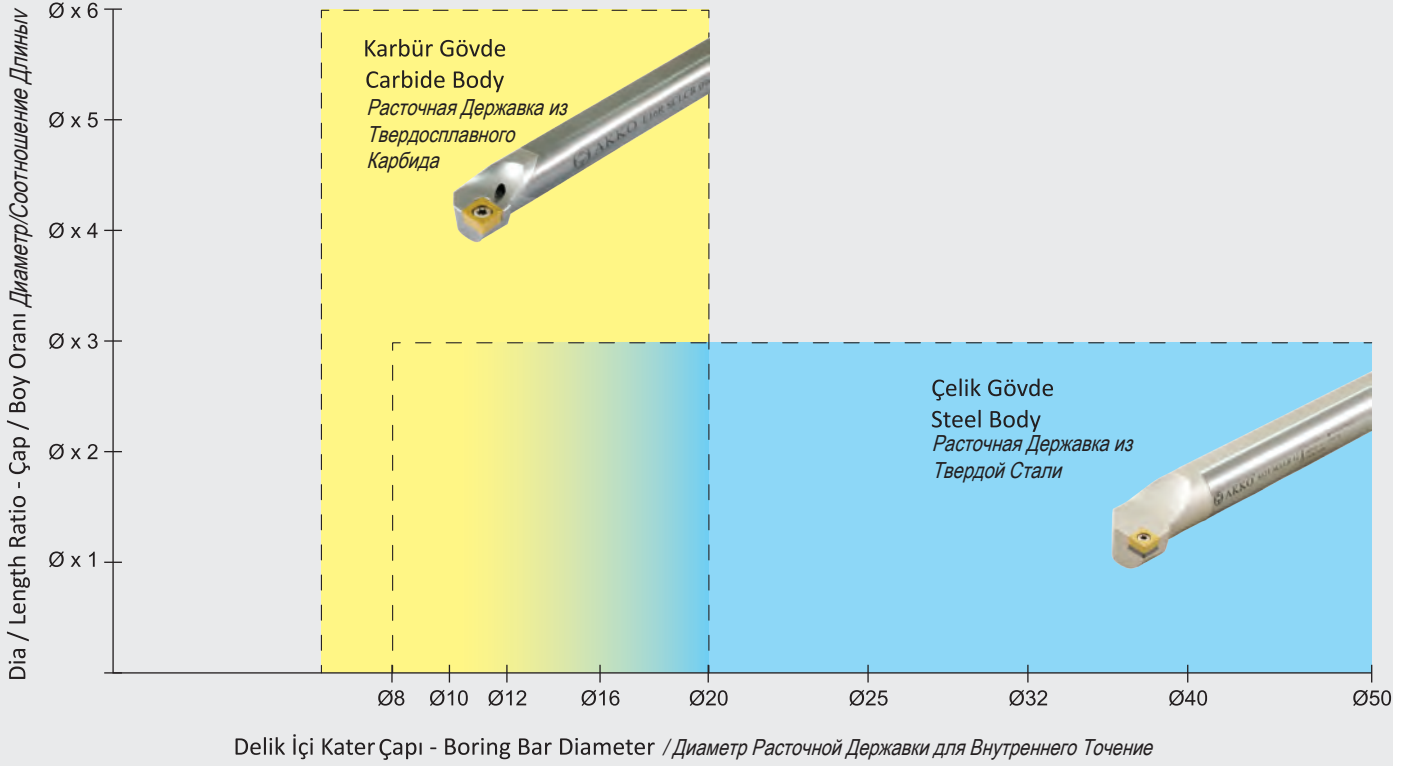

T Kanal Freze Kullanım ve Ön Hazırlama Kılavuzu

Application Guide For T-Slot Milling

Предварительная подготовка заготовки для прорезания T-образных пазов

T kanal frezelemede talaşın rahat boşaltılması için iş parçası resimde gösterildiği şekilde işlenmelidir.

Örnek: ATSM90-CC06- D32X10-W25- L100-Z04 kodlu T freze ile kanal açmadan önce, takımın boğazının çalışacağı kısmın parmak freze ile işlenmesi gerekir. Bu durumda kanalın tamamen işlenmesi çok yanlıştır. Tabanda ($0.8 \times b = 0.8 \times 10$) 8mm işlenmeden bırakılmalıdır. Bu bölgeyi T frezinin işlemesi, takımın daha sağlıklı çalışması açısından gereklidir.

İşlenen kanallarda yumuşak kesim için talaşlar uzaklaştırılmış olmalıdır.

When T slot machining steel, the workpiece must be machined as shown in the drawing to ensure smooth chip evacuation.

Example: Before slotting with the T - slot milling cutter - code ATSM90-CC06-D32X10-W25-L100-Z04,

The area of the neck of the tools to be worked and must be machined by End-Mill.

In this case, it is very wrong to machining the slot completely.

Bottom area ($0.8 \times b = 0.8 \times 10$) should be left 8 mm without machining.

This area's operation must be machined by the T - slot milling cutter which is also necessary for the healthier work of the tool holder. Slots to be machined must be free from chips for smooth machining.

При обработке T-образных пазов необходимо прорезать предварительную канавку согласно эскиза.

Пример: ATSM90-CC06-d32x10-w25-l100-z04 - грибковая фреза $\varnothing 32$ мм и шириной 10 мм.

Первоначально фрезеруют прямоугольный паз шириной равной или меньшей узкой части T-паза и глубиной равной полной глубине, либо с гарантированным перекрытием поднутрения. Максимальный припуск на грибковую фрезу не должен превышать 80% от ширины b. Для вышеуказанной фрезы допустимый припуск 8 мм.

После предварительной прорезки паза необходимо удалить стружку до начала работы грибковой фрезы.

KULLANIM İÇİN UYARI
CAUTION FOR USE
ВАЖНО ДЛЯ ИСПОЛЬЗОВАНИЯ

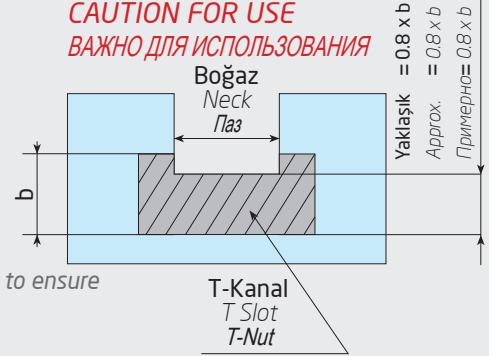

α = 5 Kat Dayanıklılık**α = 5 Times Long Life****α = В 5 раз больше устойчивости****Alfa Kaplamanın Avantajları***Alpha Coating Advantages***Преимущество Альфа покрытия**

- **Yüksek aşınma direnci**
High resistance to abrasion
Высокая стойкость к износу
- **Yüksek yüzey sertliği**
750-800 Vickers
High surface hardness
750-800 Vickers
Высокая твердость поверхности 750-800 Vickers
- **Temperlemeye karşı yüksek direnç**
High resistance to tempering
Высокая устойчивость температуры отпуска
- **Yüksek yorulma mukavemeti**
High fatigue strength
Высокая прочность от усталости
- **Yüksek çizik ve çentik direnci**
High scratch and impact resistance
Высокая устойчивость от царапин и вырезов
- **Paslanmaz olmayan çelikler için daha yüksek korozyon direnci**
Resistant to corrosion of non-stainless steel
Устойчивость от коррозии из нержавеющей стали

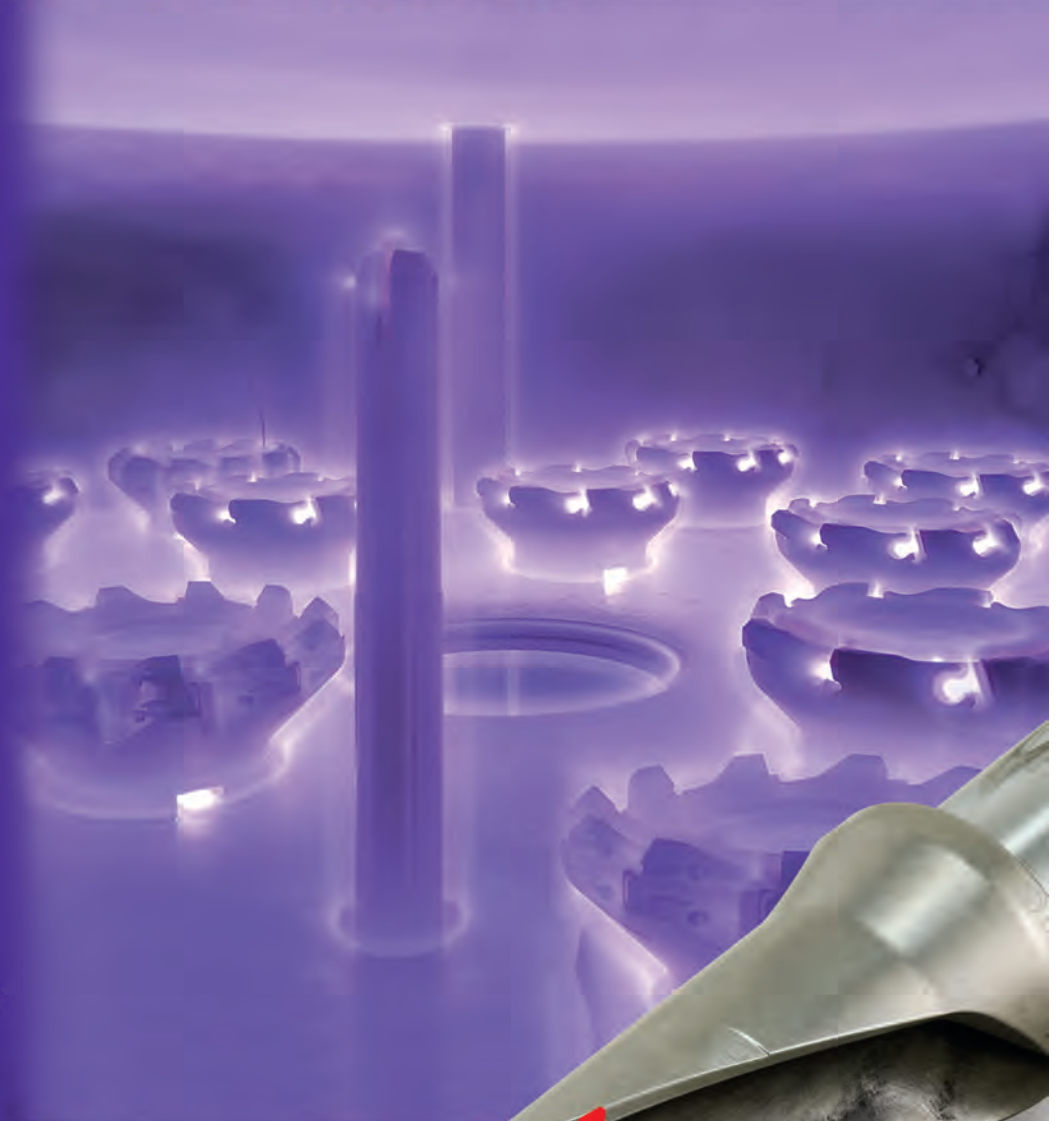

takımınız neden
daha uzun ömürlü
olmasın?...

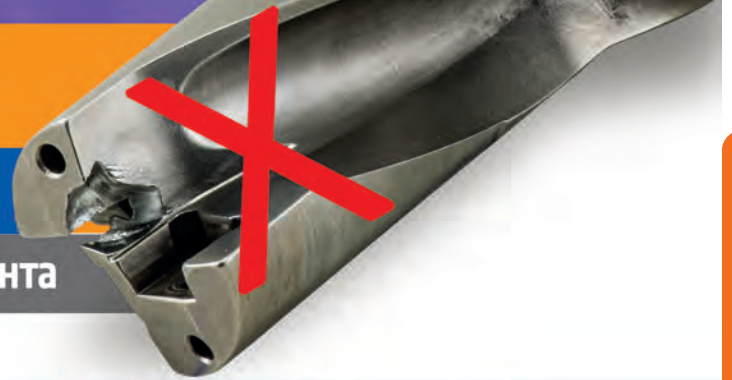
longer tool life...**Более длительный срок службы инструмента**

α Çevre Dostudur. α is friend of environment.
α Является другом окружающей среды

İnsan sağlığı açısından zararlı değildir. Is not harmful to human health.
Не вреден для здоровья человека

Gas ve diğer atıkları çevreyi kirlilemez. Gas and other wastes will not pollute the environment.
Не загрязняет окружающую среду



ALTLIKLAR / SHIMS / ОПОРНЫЕ ПЛАСТИНЫ

ÜRÜN RESMİ/PICTURE ИЗОБРАЖЕНИЕ	ÜRÜN KODU/CODE КОД	ÜRÜN DETAYI / PRODUCT DETAIL ОПИСАНИЕ	
	AATN-2-0001	S-SİSTEM için / For S-SYSTEM / S-ТИП	
	AATN-2-0002	T-M SİSTEM için / For T-M SYSTEM / T-M ТИП	
	AATN-3-0025	P-SİSTEM için / For P-SYSTEM / P-ТИП	
	AATN-3-0015	T-M-P SİSTEM için / For T-M SYSTEM / T-M-P ТИП	
	AATN-2-0020	DIŞ VİDA 16 ALTLIK / For THREADING 16 SHIM / РЕЗЬБОВАЯ ОПОРНАЯ ПЛАСТИНА 16	
	AATN-2-0004	DIŞ VİDA 22 ALTLIK / For THREADING 22 SHIM / РЕЗЬБОВАЯ ОПОРНАЯ ПЛАСТИНА 22	
	ATS-16E	DIŞ VİDA 16, DIŞ ÇAP SAĞ - DELİK İÇİ SOL ALTLIK / For THREADING SYSTEM 16 SHIM, EXTERNAL RIGHT-INTERNAL LEFT / РЕЗЬБОВАЯ ОПОРНАЯ ПЛАСТИНА 16, НАРУЖНАЯ ПРАВАЯ - ВНУТРЕННЯЯ ЛЕВАЯ	
	ATS-16I	DIŞ VİDA 16, DIŞ ÇAP SOL - DELİK İÇİ SAĞ ALTLIK / For THREADING SYSTEM 16 SHIM, EXTERNAL LEFT-INTERNAL RIGHT / РЕЗЬБОВАЯ ОПОРНАЯ ПЛАСТИНА 16, НАРУЖНАЯ ЛЕВАЯ - ВНУТРЕННЯЯ ПРАВАЯ	
	ATS-22E	DIŞ VİDA 22, DIŞ ÇAP SAĞ - DELİK İÇİ SOL ALTLIK / For THREADING SYSTEM 22 SHIM, EXTERNAL RIGHT-INTERNAL LEFT / РЕЗЬБОВАЯ ОПОРНАЯ ПЛАСТИНА 22, НАРУЖНАЯ ПРАВАЯ - ВНУТРЕННЯЯ ЛЕВАЯ	
	ATS-22I	DIŞ VİDA 22, DIŞ ÇAP SOL - DELİK İÇİ SAĞ ALTLIK / For THREADING SYSTEM 22 SHIM, EXTERNAL LEFT-INTERNAL RIGHT / РЕЗЬБОВАЯ ОПОРНАЯ ПЛАСТИНА 22, НАРУЖНАЯ ЛЕВАЯ - ВНУТРЕННЯЯ ПРАВАЯ	
	ATS-27E	DIŞ VİDA 27, DIŞ ÇAP SAĞ - DELİK İÇİ SOL ALTLIK / For THREADING SYSTEM 27 SHIM, EXTERNAL RIGHT-INTERNAL LEFT / РЕЗЬБОВАЯ ОПОРНАЯ ПЛАСТИНА 27, НАРУЖНАЯ ПРАВАЯ - ВНУТРЕННЯЯ ЛЕВАЯ	
	ATS-27I	DIŞ VİDA 27, DIŞ ÇAP SOL - DELİK İÇİ SAĞ ALTLIK / For THREADING SYSTEM 27 SHIM, EXTERNAL LEFT-INTERNAL RIGHT / РЕЗЬБОВАЯ ОПОРНАЯ ПЛАСТИНА 27, НАРУЖНАЯ ЛЕВАЯ - ВНУТРЕННЯЯ ПРАВАЯ	
	AACN-2-0001	S-SİSTEM için / For S-SYSTEM / S-ТИП	
	AACN-2-0002	T-SİSTEM için / For T-SYSTEM / T-ТИП	
	AACN-2-0003	P-SİSTEM için / For P-SYSTEM / P-ТИП	
	AACN-3-0001	T-M-P SİSTEM için / For T-M-P SYSTEM / T-M-P ТИП	
	AACN-3-0002	T-P SİSTEM için / For T-P SYSTEM / T-P ТИП	
	AACN-3-0003	T-P SİSTEM için / For T-P SYSTEM / T-P ТИП	
	AACN-3-0008	T-P SİSTEM için / For T-P SYSTEM / T-P ТИП	
	AACN-3-0003	C-SİSTEM için / For C-SYSTEM / C-ТИП	
	AAWN-2-0003	T-M-P SİSTEM için / For T-M-P SYSTEM / T-M-P ТИП	
	AAWN-3-0001	T-M-P SİSTEM için / For T-M-P SYSTEM / T-M-P ТИП	
	AAWN-SW317	T-M-P SİSTEM için / For T-M-P SYSTEM / T-M-P ТИП	
	AKS-16L	C-SİSTEM için / For C-SYSTEM / C-ТИП	
	AKS-16R	C-SİSTEM için / For C-SYSTEM / C-ТИП	
	AASD-3-0001	S-SİSTEM FREZELEME için / For S-SYSTEM MILLING / S-ТИП ПРИЖИМ ДЛЯ ФРЕЗ ПОД	
	AASE-3-0001	S-SİSTEM FREZELEME için / For S-SYSTEM MILLING / S-ТИП ПРИЖИМ ДЛЯ ФРЕЗ ПОД	
	AASN-2-0001	S-SİSTEM için / For S-SYSTEM / S-ТИП	
	AASN-2-0002	P-SİSTEM için / For P-SYSTEM / P-ТИП	
	AASN-2-0004	S-SİSTEM için / For S-SYSTEM / S-ТИП	
	AASN-3-0004	T-P SİSTEM için / For T-P SYSTEM / T-P ТИП	
	AASN-3-0004	C-SİSTEM için / For C-SYSTEM / C-ТИП	
	AASN-3-0023	T-P SİSTEM için / For T-P SYSTEM / T-P ТИП	
	AASN-3-0005	T-P SİSTEM için / For T-P SYSTEM / T-P ТИП	
	AASN-3-0020	T-P SİSTEM için / For T-P SYSTEM / T-P ТИП	
	AASN-20020	PSDNN KARTUŞ için / For PSDNN CARTRIDGE / ДЛЯ КАРТРИДЖЕЙ	
		AADN-2-0001	S-SİSTEM için / For S-SYSTEM / S-ТИП
		AADN-SD317	P-SİSTEM için / For P-SYSTEM / P-ТИП
AADN-3-0001		T-M-P SİSTEM için / For T-M-P SYSTEM / T-M-P ТИП	
AADN-2-0003		T-SİSTEM için / For T-SYSTEM / T-ТИП	
	AAVN-2-0002	S-SİSTEM için / For S-SYSTEM / S-ТИП	
	AAVN-2-0003	S-SİSTEM için / For S-SYSTEM / S-ТИП	
	AAVN-2-0003	S-SİSTEM için / For S-SYSTEM / S-ТИП	
	AARC-3-0001	C-SİSTEM için / For C-SYSTEM / C-ТИП	
	AARC-3-0002	C-SİSTEM için / For C-SYSTEM / C-ТИП	
	AARC-3-0003	C-SİSTEM için / For C-SYSTEM / C-ТИП	

BASKI PABUÇLARI / CLAMPS / ПРИЖИМ

ÜRÜN RESMİ/PICTURE BILD	ÜRÜN KODU/CODE КОД	ÜRÜN DETAYI / PRODUCT DETAIL ОПИСАНИЕ
	ATK-01	T-SİSTEM için / For T-SYSTEM / T-ТИП DNMG 11, WNMG 06, TNMG 16, CNMG 09 BASKI PABUCU / CLAMP / ПРИЖИМ
	ATK-02	T-SİSTEM için / For T-SYSTEM / T-ТИП CNMG 12, WNMG 08, TNMG 22, DNMG 15, SNMG 12 BASKI PABUCU / CLAMP / ПРИЖИМ
	ATK-03	T-SİSTEM için / For T-SYSTEM / T-ТИП VNMG 16 BASKI PABUCU / CLAMP / ПРИЖИМ
	ATK-04	T-SİSTEM için / For T-SYSTEM / T-ТИП CNMG 16, SNMG 15 BASKI PABUCU / CLAMP / ПРИЖИМ
	ATKH-01-R	T-SİSTEM için / For T-SYSTEM / T-ТИП İÇTEN SOĞUTMA KANALLI BASKI PABUCU / WITH COOLANT TOOLS / С ПОДВОДОМ СОЖ
	ATKH-02-L	T-SİSTEM için / For T-SYSTEM / T-ТИП İÇTEN SOĞUTMA KANALLI BASKI PABUCU / WITH COOLANT TOOLS / С ПОДВОДОМ СОЖ
	AMK-01	M-SİSTEM için / For M-SYSTEM / M-ТИП WNMG 06 BASKI PABUCU / CLAMP / ПРИЖИМ
	AMK-02	M-SİSTEM için / For M-SYSTEM / M-ТИП DELİK İÇİ / INTERNAL Ø20 TNMG 16, Ø25 MT-NR/L 16 BASKI PABUCU / CLAMP M-ТИП ПРИЖИМ ДЛЯ РАСТОЧНЫХ ДЕРЖАВОК Ø20, Ø25 MT-NR/L 16 ПОД TNMG 16
	AMK-03	M-SİSTEM için / For M-SYSTEM / M-ТИП DNMG 11, CNMG 12 BASKI PABUCU / CLAMP / ПРИЖИМ
	AMK-04	M-SİSTEM için / For M-SYSTEM / M-ТИП DNMG 15, TNMG 16-22 BASKI PABUCU / CLAMP / ПРИЖИМ
	AMK-05	M-SİSTEM için / For M-SYSTEM / M-ТИП WNMG 08 BASKI PABUCU / CLAMP / ПРИЖИМ
	AMK-07	M-SİSTEM için / For M-SYSTEM / M-ТИП S20R MCLNR/L BASKI PABUCU / CLAMP / ПРИЖИМ
	AMK-08	M-SİSTEM için / For M-SYSTEM / M-ТИП TNMG 22 BASKI PABUCU / CLAMP / ПРИЖИМ
	ACK-01-R	C-SİSTEM için / For C-SYSTEM / C-ТИП KNUX-R BASKI PABUCU / CLAMP / ПРИЖИМ
	ACK-02-L	C-SİSTEM için / For C-SYSTEM / C-ТИП KNUX-L BASKI PABUCU / CLAMP / ПРИЖИМ
	ACK-03	C-SİSTEM için / For C-SYSTEM / C-ТИП 154.91 DIŞ ÇAP ve DELİK İÇİ/EXTERNAL and INTERNAL/ ДЛЯ НАРУЖНЫХ И ВНУТРЕННИХ ОБРАБОТОК / ПРИЖИМ Ø25-Ø32 / PABUCU / CLAMP
	ACK-04	P-C-SİSTEM için / For P-C-SYSTEM / P-СТИП CTFPR KARTUŞ BASKI PABUCU / CARTRIDGE CLAMP / ПРИЖИМ ДЛЯ КАРТРИДЖЕЙ
	ACK-05	P-C-SİSTEM için / For P-C-SYSTEM / P-СТИП FREZELEME ve DIŞ VİDA AÇMA TAKIMLARINA GÖRE İLAVE BASKI PABUCU ADDITIONAL LITTLE CLAMP for MILLING and THREADING CLAMP P-C-ТИП ДОПОЛНИТЕЛЬНЫЙ ПРИЖИМ ДЛЯ ФРЕЗ И РЕЗЬБОВЫХ ДЕРЖАВОК
	ACK-06	C-SİSTEM için / For C-SYSTEM / C-ТИП 154.91 DELİK İÇİ / INTERNAL / İNVEN Ø16-Ø20 BASKI PABUCU / CLAMP / ПРИЖИМ
	ACK-07	C-SİSTEM için / For C-SYSTEM / C-ТИП SERAMİK CNGN, SNGN, DNGN YEDEK TAKIMI SPARE PART SET of CERAMIC CNGN, SNGN, DNGN C-ТИП ЗАПАСНОЙ КОМПЛЕКТ ПОД КЕРАМИЧЕСКУЮ ПЛАСТИНУ CNGN, SNGN, DNGN
	ACK-08	C-SİSTEM için / For C-SYSTEM / C-ТИП SERAMİK TNGN, YEDEK TAKIMI SPARE PART SET of CERAMIC TNGN C-ТИП ЗАПАСНОЙ КОМПЛЕКТ ПОД КЕРАМИЧЕСКУЮ ПЛАСТИНУ TNGN
	ACK-09	P-SİSTEM için / For P-SYSTEM / P-ТИП CNMG 16-19, SNMG 15-19 İLAVE BÜYÜK BASKI PABUCU ADDITIONAL BIG CLAMP / P-ТИП ДОПОЛНИТЕЛЬНЫЙ БОЛЬШОЙ ПРИЖИМ ПОД CNMG 16-19, SNMG 15-19
	ACK-10	C-SİSTEM FREZELEME için / For C-SYSTEM MILLING C-ТИП ПРИЖИМ ДЛЯ ФРЕЗ ПОД SPKN 12, Ø50-Ø63 TRKN 16 BASKI PABUCU / CLAMP / ПРИЖИМ (M8x8)
	ACK-11	C-SİSTEM FREZELEME için / For C-SYSTEM MILLING C-ТИП ПРИЖИМ ДЛЯ ФРЕЗ ПОД Ø80-Ø100 TRKN 16-TRKN 22, OFKR 07, HNMX 09 BASKI PABUCU / CLAMP / ПРИЖИМ (M8x10)
	ACK-12	C-SİSTEM için / For C-SYSTEM / C-ТИП CTSPR KARTUŞ BASKI PABUCU / CARTRIDGE CLAMP / ПРИЖИМ ДЛЯ КАРТРИДЖЕЙ
	ACK-15	S-SİSTEM FREZELEME için / For S-SYSTEM MILLING S-ТИП ПРИЖИМ ДЛЯ ФРЕЗ ПОД RD.. 10-12 BASKI PABUCU / CLAMP / ПРИЖИМ
	ACK-19	S-SİSTEM FREZELEME için / For S-SYSTEM MILLING S-ТИП ПРИЖИМ ДЛЯ ФРЕЗ ПОД WD0805D BASKI PABUCU / CLAMP / ПРИЖИМ
	ACK-21	C-SİSTEM için / For C-SYSTEM / C-ТИП SN.. 1204.. BASKI PABUCU / CLAMP / ПРИЖИМ
	ACK-23	C-SİSTEM için / For C-SYSTEM / C-ТИП SERAMİK DNGN 11, YEDEK TAKIMI SPARE PART SET of CERAMIC DNGN 11 C-ТИП ЗАПАСНОЙ КОМПЛЕКТ ПОД КЕРАМИЧЕСКИЕ ПЛАСТИНЫ DNGN 11
	ACK-24	S-SİSTEM FREZELEME için / For S-SYSTEM MILLING S-ТИП ПРИЖИМ ДЛЯ ФРЕЗ ПОД XD0806D BASKI PABUCU / CLAMP / ПРИЖИМ
	ACK-26	C-SİSTEM için / For C-SYSTEM / C-ТИП XNMU 0806.. BASKI PABUCU / CLAMP / ПРИЖИМ
	ACK-27	C-SİSTEM için / For C-SYSTEM / C-ТИП RCGX 06 BASKI PABUCU / CLAMP / ПРИЖИМ
	ACK-28	C-SİSTEM için / For C-SYSTEM / C-ТИП RCGX 09 BASKI PABUCU / CLAMP / ПРИЖИМ
	ACK-29	C-SİSTEM için / For C-SYSTEM / C-ТИП RCGX 12 BASKI PABUCU / CLAMP / ПРИЖИМ

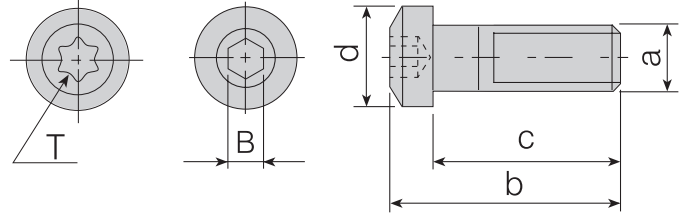

BASKI PABUÇ VIDALARI / CLAMP SCREWS / ВИНТЫ ДЛЯ ПРИЖИМОВ

Takım Kodu Ordering Code Код для заказа	a (M)	b	c	d	B(T)	Ürün Detayı / Product Detail / Описание
AKV-01-M5X22	M5x0.8	25.1	22	11	3	T-SİSTEM için / For T-SYSTEM / Т-ТИП DNMG 11, WNMG 06, TNMG 16
AKV-02-M6X22	M6x1.0	25.3	22	11	3	T-SİSTEM için / For T-SYSTEM / Т-ТИП CNMG 12, WNMG 08, TNMG 22, DNMG 15, SNMG 12, VNMG 16
						M-SİSTEM için / For M-SYSTEM / М-ТИП TNMG 16, TNMG 22
AKV-03-M6X22	M6x1.0	25.3	22	10	3	KANAL KATERİ için / For EXTERNAL GROOVING 2mm Dış Çap Kanal Kater Vidası / External Grooving Tools Screw
						ДЛЯ КАНАВЧОЧНЫХ ДЕРЖАВОК 2мм Державка для обработки наружных канавок с подводом СОЖ
AKV-04-M5X17	M5x0.8	20	17	8.5	3	M-SİSTEM için / For M-SYSTEM / М-ТИП WNMG 08
AKV-05-M6X25	M6x1.0	29.5	25	13.8	4	M-SİSTEM için / For M-SYSTEM / М-ТИП S20R MT-NR/L 16, S20R-S25S MWLNR/L 06, S25S MDUNR/L 11-Dış Çap / External / AUßEN MWLNR 06
AKV-06-M6X20	M6x1.0	26.5	20	10.6	4	T-SİSTEM için / For T-SYSTEM / Т-ТИП Eski Ürün Vidası / Old Products Screws / Винт устаревшей конструкции CNMG 16, SNMG 15
AKV-07-M6X22	M6x1.0	23.5	22	8.5	3	C-SİSTEM için / For C-SYSTEM / С-ТИП KNUX 16
AKV-10-M6X14	M6x1.0	16	14	8.8	4	C-SİSTEM için / For C-SYSTEM / С-ТИП ADKT-154.91, AIKT-154.91-R/L-32
AKV-11-M8X29	M8X1.25	33.6	29	11	4	C-SİSTEM için / For C-SYSTEM / С-ТИП AIKT-154.91-R/L-16, AIKT-154.91-R/L-20, AIKT-154.91-R/L-25
AKV-17-M5X15	M5X0.8	18	15	8.55	3	C-SİSTEM için / For C-SYSTEM / С-ТИП TNGN 16, CNGN 12, DNGN 15, SNGN 12
AKV-19-M7X25	M7X1.0	29.6	25	14	4	M-SİSTEM için / For M-SYSTEM / М-ТИП S16P MWLNR/L 06
AKV-20-M6X19	M6x1.0	22	19	11	3	T-SİSTEM için / For T-SYSTEM / Т-ТИП Yeni / New / Новинка CNMG 16, SNMG 15
AKV-21-M6X18	M6x1.0	20	18	8.5	3	M-SİSTEM için / For M-SYSTEM / М-ТИП S25S MDUNR/L 15
AKV-23-M4X10	M4x0.7	12.2	10	7.4	15	C-SİSTEM için / For C-SYSTEM / С-ТИП AIKT-154.91-R/L-25
AKV-27-M6X20	M6x1.0	23.3	20	10	3	KARTUŞ için / For CARTRIDGE / ДЛЯ КАРТРИДЖЕЙ MONTAJ VIDASI / MOUNTING SCREW / МОНТАЖНЫЙ ВИНТ
AKV-30-M6X22	M6x1.0	25.3	22	11	3	M-SİSTEM için / For M-SYSTEM / М-ТИП S25S MWLNR/L 08
AKV-33-M6X22	M6x1.0	25.3	22	9.5	3	T-SİSTEM için / For T-SYSTEM / Т-ТИП Baskı Pabucu / Wedge Clamp / Прижим

SOĞUTMA NOZULU / COOLANT NOZZLE / ПРИЖИМ С ПОДВОДОМ СОЖ

Ürün Resmi Product Picture Изображение	Ürün Kodu Product Code / Код	Ürün Detayı / Product Detail / Описание
	AN-01	SOĞUTMA NOZULU / Coolant Nozzle / Прижим С Подводом Сож SOĞUTMA NOZULU / Coolant Nozzle / Прижим С Подводом Сож

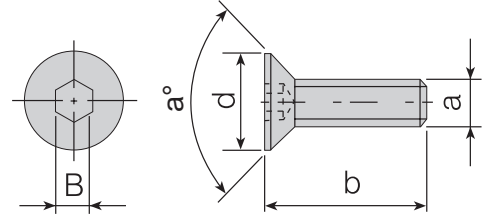

Takım Kodu Ordering Code Код для заказа	ALTLIK VIDALARI / SHIM SCREWS / ВИНТ ОПОРНОЙ ПЛАСТИНЫ					Ürün Detayı / Product Detail / Описание
	a (M)	b	d	B	a°	
AAV-01-M3x10	M3X0.5	10	5.9	2	90°	T-SİSTEM için / For T-SYSTEM / Т-ТИП / WNMG 06, KNUX 16
AAV-02-M5X12	M5X0.8	12	7	3	56°	T-SİSTEM için / For T-SYSTEM / Т-ТИП / CNMG 12, WNMG 08, TNMG 22, DNMG 15, SNMG 12
AAV-05-M6X15	M6X1.0	15	9	4	60°	T-SİSTEM için / For T-SYSTEM / Т-ТИП / CNMG 16, SNMG 15
AKV-12-M5X12	M5X0.8	12	7.8	3	90°	C-SİSTEM için / For C-SYSTEM / С-ТИП / CTSPR Baskı Pabuç Vidası / Clamp Screw / Зажимной винт
AKV-16-M6X16	M6X1.0	16	10	4	76°	C-SİSTEM için / For C-SYSTEM / С-ТИП / CTFPR 13CS 16 Baskı Pabuç Vidası / Clamp Screw / Зажимной винт
AAV-13-M5X8	M5X0.8	8	7	3	56°	T-SİSTEM için / For T-SYSTEM / Т-ТИП / S25S TSKNR/L 12, S25S TCLNR/L 12, S25S TWLNR/L 08, S25S TDUNR/L 15
AAV-14-M5X14	M5X0.8	14	8.8	3	45°	ADCR için / For ADCR / FÜR ADCR / ADCR Montaj Vidası / Mounting Screw / ADCR Монтажный винт

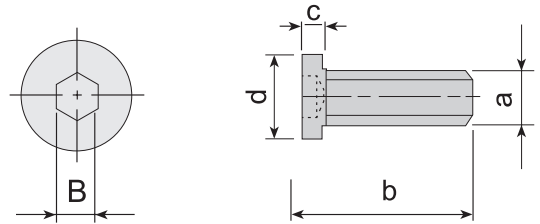

Takım Kodu Ordering Code Код для заказа	ALTLIK VIDALARI / SHIM SCREWS / ВИНТ ОПОРНОЙ ПЛАСТИНЫ					Ürün Detayı / Product Detail / Описание
	a (M)	b	c	d	B	
AAV-03-M5X12	M5X0.8	12	1.4	6	3	T-SİSTEM için / For T-SYSTEM / Т-ТИП / TNMG 16 C-SİSTEM için / For C-SYSTEM / С-ТИП / TNGN 16
AAV-04-M5X12	M5X0.8	12	1.2	6.5	3	T-SİSTEM için / For T-SYSTEM / Т-ТИП / VNMG 16, DNMG 11, CNMG 09
AAV-09-M5X9	M5X0.8	9	1.4	6	3	T-SİSTEM için / For T-SYSTEM / Т-ТИП / S25S TCLNR/L 09, S25S TDUNR/L 11, S25S TDQNR/L 11

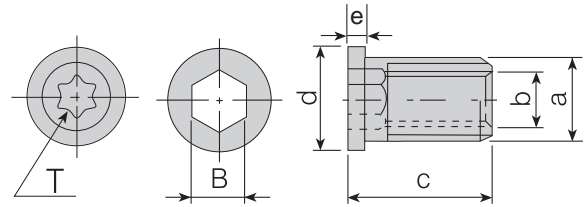

Takım Kodu Ordering Code Код для заказа	BUKSE VIDALAR / BUKSE SCREWS / ВИНТ ОПОРНОЙ ПЛАСТИНЫ						Ürün Detayı / Product Detail / Описание
	a (M)	b	c	d	B(T)	e	
AAV-06-M3.5X11	M5x0.5	M3.5x0.6	11.3	6	3.5	1.2	S-SİSTEM için / For S-SYSTEM / S-ТИП / CCMT 09, DCMT 11, VBMT 16, VCMT 16, TCMT 16, SCMT 09, 16 ER/L, 16 IR/L
AAV-07-M4.5X13	M6X0.75	M4.5X0.75	13	7.5	4.5	1.6	S-SİSTEM için / For S-SYSTEM / S-ТИП / CCMT 12, SCMT 12, 22 ER/L, 22 IR/L
AAV-08-M3.5X8	M5X0.5	M3.5x0.6	8	6	20	1.2	S-SİSTEM için / For S-SYSTEM / S-ТИП / Ø25 DCMT 11, Ø25-Ø32 CCMT 09, Ø25 TCMT 16, S25S-S32T SVJBR/L 16,
AAV-10-M4.5X8	M6X0.75	M4.5X0.75	8	7.5	4.5	1.05	S-SİSTEM için / For S-SYSTEM / S-ТИП / Ø25-Ø32 CCMT 12, Ø25-Ø32 SCMT 12, SSDCN 1616 H12, SSSCR/L 1616 H12, SIR/L S25R 22
AAV-16-M3.5X8	M5X0.5	M3.5x0.6	8	6	20	1.1	S-SİSTEM için / For S-SYSTEM / S-ТИП / SEMT 13

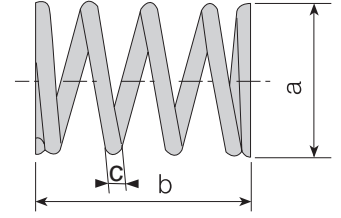
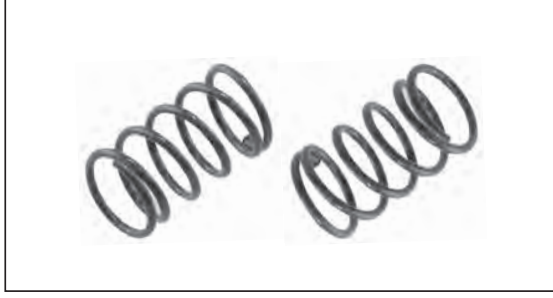

BASKI YAYI / CLAMP SPRING / ПРУЖИНЫ					
Takım Kodu Ordering Code Код для заказа	a	b	c	Ürün Detayı / Product Detail / Описание	
AKY-01	7.7	11.2	0.9	T-SİSTEM için / For T-SYSTEM / Т-ТИП	CNMG 12, WNMG 08, TNMG 22, DNMG 15, SNMG 12, VNMG 16
AKY-02	8.5	13.5	0.7	C-SİSTEM için / For C-SYSTEM / С-ТИП	KNUX 16

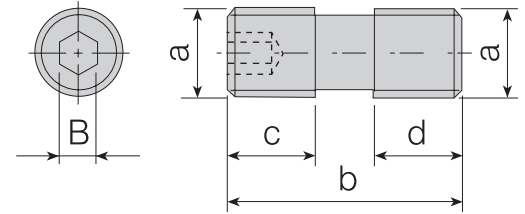

BASKI PABUÇ VİDALARI / CLAMP SCREWS / ВИНТ ДЛЯ ОПОРНОЙ ПЛАСТИНЫ							
Takım Kodu Ordering Code Код для заказа	a (M)	b	c	d	B	Ürün Detayı / Product Detail / Описание	
AKV-13-M8X1X16	M8x1.0	16	6.8	6.8	4	C-SİSTEM FREZELEME için / MILLING For C- SYSTEM / С-ТИП	SPKN 12, Ø63 TPKN 16
AKV-14-M8X1X18	M8x1.0	18	8	8	4	C-SİSTEM FREZELEME için / MILLING For C- SYSTEM / С-ТИП	Ø80-Ø100 TPKN 16, Ø63-Ø315 TPKN 22
AKV-15-M8X1X20	M8x1.0	20	8.5	8.5	4	C-SİSTEM FREZELEME için / MILLING For C- SYSTEM / С-ТИП	OFKR 07, HNMX 09
AKV-18-M5X14	M5X0.8	15	5	6.8	2.5	C-SİSTEM FREZELEME için / MILLING For C- SYSTEM / С-ТИП	SN19
AKV-22-M8X1X14	M8x1.0	14	6.8	4.8	4	C-SİSTEM FREZELEME için / MILLING For C- SYSTEM / С-ТИП	Ø50 TPKN 16
AKV-24-M6X1X18	M6x1.0	18	7.5	7.5	3	C-SİSTEM FREZELEME için / MILLING For C- SYSTEM / С-ТИП	SN.. 1204
AKV-26-M6X0.75X20	M6x0.75	20	8.5	8.5	3	C-SİSTEM FREZELEME için / MILLING For C- SYSTEM / С-ТИП	AFM45C-XN0806
AKV-28-M10x1.5x43	M10x1.5	43	18	18	5	WNMU 0907.. Ø50 MONTAJ VIDASI / MOUNTING SCREW / Монтажный винт	WNMU 0907.. Ø50

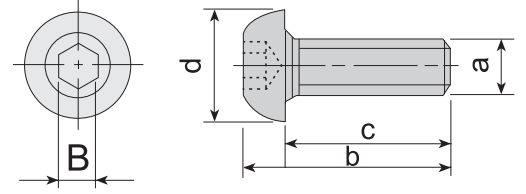

KANAL KATER ve MANTAR VİDALAR / GROOVING TOOL and CLAMP SCREWS / ЗАЖИМНОЙ ВИДН

Takım Kodu Ordering Code Код для заказа	a (M)	b	c	d	B	Ürün Detayı / Product Detail / Описание
1904-M8X1X20	M8X1.0	25.9	20	11.3	4	S-SİSTEM için / For S-SYSTEM / S-ТИП RCMT 32 Sıkma Vidası / Clamp Screw / Зажимной Винт
2004-M8X1X20	M8X1.0	25.9	20	11.4	4	KANAL KATERİ için / For EXTERNAL GROOVING / FÜR TMG-16, TMG-22 BOHRSTANGE Kanal Kater Vidası / External Grooving Tools Screw / Державка для обработки наружных канавок с подводом СОЖ
2004-M8X20	M8X1.25	30	25	25	4	KANAL KATERİ için / For EXTERNAL GROOVING / FÜR TMG-16, TMG-22 BOHRSTANGE Eski Kanal Kater Vidası / Old External Grooving Tools Screw Alte / Schraube für Stechhalter
AKV-08-M6X12	M6x1.0	17	12	14.3	4	C-SİSTEM FREZELEME için / MILLING For C-SYSTEM / C-SYSTEM FÜR FRÄSER Baskı ve Sıkma Vidası, Mantar Vida / Clamp Screw / Зажимной Винт
AKV-09-M8X18	M8X1.0	24	18	17.2	5	C-SİSTEM FREZELEME için / MILLING For C-SYSTEM / C-SYSTEM FÜR FRÄSER Baskı ve Sıkma Vidası, Mantar Vida / Clamp Screw / Зажимной Винт

LEVYELER / LEVERS / РЫЧАГИ

Ürün Resmi Product Picture Изображение	Ürün Kodu Product Code / КОД	Ürün Detayı / Product Detail / Описание
	APL-01	P-SİSTEM için / For P-SYSTEM / P-ТИП CNMG 09, DNMG 11, SNMG 09, TNMG 16, WNMG 06 LEVYESİ / LEVER / РЫЧАГИ
	APL-02	P-SİSTEM için / For P-SYSTEM / P-ТИП CNMG 12, SNMG 12, TNMG 22, WNMG 08 LEVYESİ / LEVER / РЫЧАГИ
	APL-03	P-SİSTEM için / For P-SYSTEM / P-ТИП DNMG 15 LEVYESİ / LEVER / РЫЧАГИ
	APL-04	P-SİSTEM için / For P-SYSTEM / P-ТИП CNMG 16, SNMG 15 LEVYESİ / LEVER / РЫЧАГИ
	APL-05	P-SİSTEM için / For P-SYSTEM / P-ТИП CNMG 19, SNMG 19 LEVYESİ / LEVER / РЫЧАГИ
	APL-06	P-SİSTEM için / For P-SYSTEM / P-ТИП CNMG 25, SNMG 25 LEVYESİ / LEVER / РЫЧАГИ
	APL-07	P-SİSTEM için / For P-SYSTEM / P-ТИП S16P PCLNR/L 09 LEVYESİ / LEVER / РЫЧАГИ
	APL-08	P-SİSTEM için / For P-SYSTEM / P-ТИП S16P PTUNR/L 16 LEVYESİ / LEVER / РЫЧАГИ
	APL-11	P-SİSTEM için / For P-SYSTEM / P-ТИП TNMG 11 LEVYESİ / LEVER / РЫЧАГИ

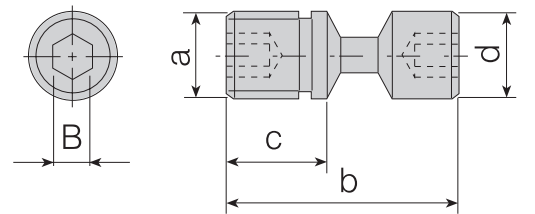

LEVYE VİDALARI / LEVER SCREWS / ФУТОРКА (ВИНТ ОПОРНОЙ ПЛАСТИН)

Takım Kodu Ordering Code Код для заказа	a (M)	b	c	d	B	Ürün Detayı / Product Detail / Описание
ALV-01-M6X14	M6x1.0	14	10	5.85	2.5	P-SİSTEM için / For P-SYSTEM / P-ТИП S20R PCLNR/L 09, S20R PDUNR/L 11, S20R PDQNR/L 11, S20R PVLNR/L 06, S20R PTUNR/L 16
ALV-02-M6X17	M6x1.0	17	10	5.85	2.5	P-SİSTEM için / For P-SYSTEM / P-ТИП CNMG 09, DNMG 11, SNMG 09, TNMG 16, WNMG 06
ALV-03-M8X19	M8X1.0	19.8	11	7.9	3	P-SİSTEM için / For P-SYSTEM / P-ТИП CNMG 12, SNMG 12, TNMG 22, WNMG 08, DNMG 15
ALV-04-M8X22	M8X1.0	21.5	13	7.75	3	P-SİSTEM için / For P-SYSTEM / P-ТИП CNMG 16, SNMG 15
ALV-05-M10X27	M10X1.0	27.5	15	9.9	4	P-SİSTEM için / For P-SYSTEM / P-ТИП CNMG 19, SNMG 19
ALV-06-M12X36	M12X1.0	36	20	12	5	P-SİSTEM için / For P-SYSTEM / P-ТИП CNMG 25, SNMG 25
ALV-07-M6X13	M6X0.1	12.6	6.5	5.9	2.5	P-SİSTEM için / For P-SYSTEM / P-ТИП S16P PCLNR/L 09, S16P PTUNR/L 16
ALV-08-M8X16	M8X1.0	16	10	7.9	3	P-SİSTEM için / For P-SYSTEM / P-ТИП S25S PCLNR/L 12, S25S PDUNR/L 15, S25S PSKNR/L 12
ALV-10-M5X10	M5x0.8	10	4.6	4.9	2.5	P-SİSTEM için / For P-SYSTEM / P-ТИП TNMG 11,

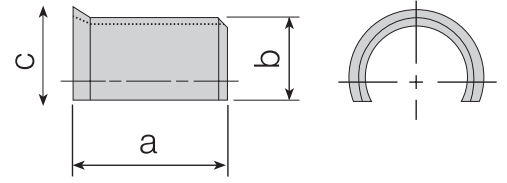

ALTLIK YAYLARI / SHIM SPRINGS / ВТУЛКА РЫЧАГА

Takım Kodu Ordering Code Код для заказа	a	b	c	Ürün Detayı / Product Detail / Описание	
				Ürün Detayı / Product Detail / Описание	Ürün Detayı / Product Detail / Описание
AAV-01	5.6	4.9	6	P-SİSTEM için / For P-SYSTEM / P-ТИП	CNMG 09 ,DNMG 11, SNMG 09, TNMG 16, WNMG 06
AAV-02	6	6.9	7.9	P-SİSTEM için / For P-SYSTEM / P-ТИП	CNMG 12, SNMG 12, TNMG 22, WNMG 08, DNMG 15
AAV-03	8.9	8	9.5	P-SİSTEM için / For P-SYSTEM / P-ТИП	CNMG 16, SNMG 15
AAV-04	11	9.8	10.7	P-SİSTEM için / For P-SYSTEM / P-ТИП	CNMG 19, SNMG 19
AAV-05	12	13	15	P-SİSTEM için / For P-SYSTEM / P-ТИП	CNMG 25, SNMG 25
AAV-07	5.6	4.9	6	P-SİSTEM için / For P-SYSTEM / P-ТИП	CNMG 09, TNMG 16

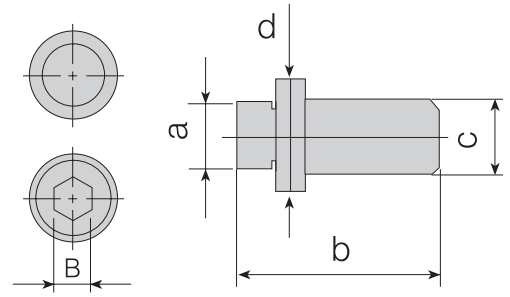
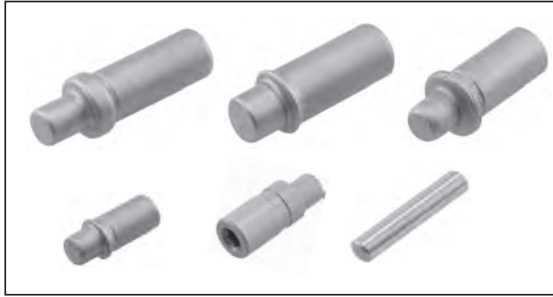

PİMLER / PINS / ШТИФТЫ

Takım Kodu Ordering Code Код для заказа	a	b	c	d	B	Ürün Detayı / Product Detail / Описание	
						Ürün Detayı / Product Detail / Описание	Ürün Detayı / Product Detail / Описание
APM-01	3.55	18	5	6	-	M-SİSTEM için / For M-SYSTEM / M-ТИП	Delik İçi / Internal / Для Внутренних Обработок Ø32-Ø40 TNMG 16 / Dış Çap / External / Для Наружных Обработок TNMG 16
APM-02	5	18	6	7.3	-	M-SİSTEM için / For M-SYSTEM / M-ТИП	TNMG 22, WNMG 08
APM-03	3.5	12	5	6.5	-	M-SİSTEM için / For M-SYSTEM / M-ТИП	S20R MTFNR/L 16, S20R MT-NR/L 16, S20R MTUNR/L 16, S20R MTQNR/L 16, S20R MDUNR/L 11
APM-04	5	15	6	7.3	-	M-SİSTEM için / For M-SYSTEM / M-ТИП	S32T MCLNR/L 12, DNMG 15, S25S MWLNR/L 08
APM-05	5	11.5	6.5	6.5	3	M-SİSTEM için / For M-SYSTEM / M-ТИП	MSYNR 11.5CS 12 Kartuş için / for Cartridge / Для картриджа
APM-06	3	15.7	-	-	-	C-SİSTEM için / For C-SYSTEM / C-ТИП	154.91
APM-07	3.5	11.5	6.5	6.5	3	M-SİSTEM için / For M-SYSTEM / M-ТИП	S20R ET-NR 16
APM-08	3.5	12	5	5.4	-	M-SİSTEM için / For M-SYSTEM / M-ТИП	S25S MWLNR/L 06, Dış Çap / External / Для Наружных Обработок
APM-09	3.5	10	5	5.4	-	M-SİSTEM için / For M-SYSTEM / M-ТИП	S16P MWLNR/L 06
APM-10	3.5	11	5	5.4	-	M-SİSTEM için / For M-SYSTEM / M-ТИП	S20R MWLNR/L 06
APM-11	3.5	11	5	6.5	-	M-SİSTEM için / For M-SYSTEM / M-ТИП	S20R MTQNR/L 16
APM-12	5	12	6	7.3	-	M-SİSTEM için / For M-SYSTEM / M-ТИП	S20R MCLNR/L 12, S25S MCLNR/L 12-Z
APM-13	5	14	6	7.3	-	M-SİSTEM için / For M-SYSTEM / M-ТИП	S25S MCLNR/L 12
APM-14	3.55	15	5	6	-	M-SİSTEM için / For M-SYSTEM / M-ТИП	S25S MTFNR/L 16, S25S MT-NR/L 16, S25S MTUNR/L 16, S25S MTQNR/L 16
APM-15	4.40	16	6.40	6.40	3	M-SİSTEM için / For M-SYSTEM / M-ТИП	MSYNR 16CS 12 Kartuş için / for Cartridge / Для картриджа

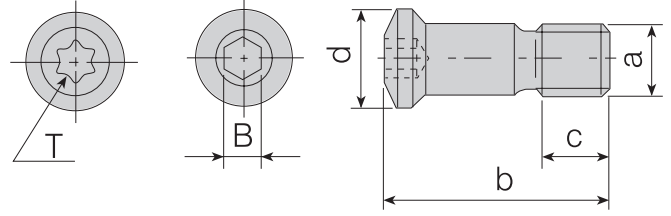

KÜRESEL FİNİŞ VİDALARI / BALL NOSE SCREWS / ВИНТЫ С ПРОТОЧКОЙ

Takım Kodu Ordering Code Код для заказа	a (M)	b	c	d	B(T)	Ürün Detayı / Product Detail / Описание	
1208-M3x7	M3x0.5	6.9	2.7	4.1	8	KÜRESEL FREZE VİDASI / BALL NOSE SCREW / ВИНТ С ПРОТОЧКОЙ	P3208
1215-M4X0.5X9	M4X0.5	8.6	3.2	5.75	15	KÜRESEL FREZE VİDASI / BALL NOSE SCREW / ВИНТ С ПРОТОЧКОЙ	P3210-ROHX 12
1220-M5X0.5X9	M5X0.5	9.6	3.4	6.8	20	KÜRESEL FREZE VİDASI / BALL NOSE SCREW / ВИНТ С ПРОТОЧКОЙ	P3212
1220-M5X0.5X12	M5X0.5	12.9	4.4	7.4	20	KÜRESEL FREZE VİDASI / BALL NOSE SCREW / ВИНТ С ПРОТОЧКОЙ	P3216-ROHX 16
1220-M5X0.5X15	M5X0.5	16.4	6	7.8	20	KÜRESEL FREZE VİDASI / BALL NOSE SCREW / ВИНТ С ПРОТОЧКОЙ	P3220-ROHX 20
1220-M6X0.75X20	M6X0.75	20	6	9.4	20	KÜRESEL FREZE VİDASI / BALL NOSE SCREW / ВИНТ С ПРОТОЧКОЙ	P3225
1204-M8X0.75X26	M8X0.75	26	7.5	12	4	KÜRESEL FREZE VİDASI / BALL NOSE SCREW / ВИНТ С ПРОТОЧКОЙ	P3232
1210-M3.5X9.6	M3.5X0.6	9.6	4	4.7	10	KÜRESEL FREZE VİDASI / BALL NOSE SCREW / ВИНТ С ПРОТОЧКОЙ	BNM 12
1215-M4X13.5	M4X0.7	13.5	5	5.8	15	KÜRESEL FREZE VİDASI / BALL NOSE SCREW / ВИНТ С ПРОТОЧКОЙ	BNM 16

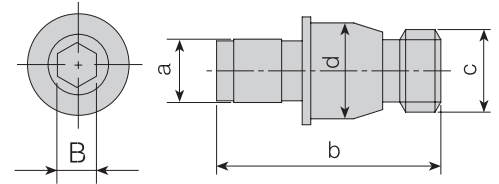
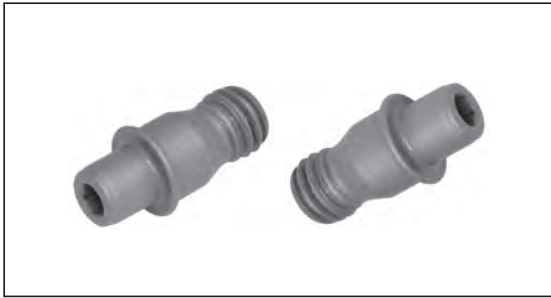

EKSANTRİK VİDA / ECCENTRIC SCREW / ВИНТ С ЭКСЦЕНТРИКОМ

Takım Kodu Ordering Code Код для заказа	a	b	c	d	B	Ürün Detayı / Product Detail / Описание	
AEV-01-M6x16	4.85	16	M6x1.0	6.5	2.5	Eksantrik Vida / Eccentric Screw / Эксцентричный винт	PSDNN Kartuş için / for Cartridge / Для картриджа

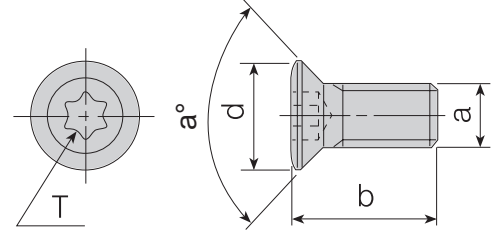

TORK VİDALARI / TORX SCREWS / ВИНТЫ TORX

Takım Kodu Ordering Code Код для заказа	a (M)	b	T	d	a°	Ürün Detayı / Product Detail / Описание	
4006-M1.6x3.2	M1.6X0.35	3.2	6	2.5	60	S-SİSTEM için / For S-SYSTEM / S-ТИП	TORK VİDA / TORX SCREW / ВИНТЫ TORX
3006-M1.8x4	M1.8X0.35	4	6	2.45	60	S-SİSTEM için / For S-SYSTEM / S-ТИП	TORK VİDA / TORX SCREW / ВИНТЫ TORX
3006-M2x3.1	M2X0.4	3.1	6	2.7	60	S-SİSTEM için / For S-SYSTEM / S-ТИП	TORK VİDA / TORX SCREW / ВИНТЫ TORX
3006-M2x3.3	M2X0.4	3.3	6	2.7	60	S-SİSTEM için / For S-SYSTEM / S-ТИП	TORK VİDA / TORX SCREW / ВИНТЫ TORX
3006-M2X3.6	M2X0.4	3.6	6	2.7	60	S-SİSTEM için / For S-SYSTEM / S-ТИП	TORK VİDA / TORX SCREW / ВИНТЫ TORX
3006-M2x4	M2X0.4	4.3	6	2.7	60	S-SİSTEM için / For S-SYSTEM / S-ТИП	TORK VİDA / TORX SCREW / ВИНТЫ TORX
4006-M2x5	M2X0.4	5	6	3	55	S-SİSTEM için / For S-SYSTEM / S-ТИП	TORK VİDA / TORX SCREW / ВИНТЫ TORX
3007-M2.2x5	M2.2X0.45	5.2	7	3.15	60	S-SİSTEM için / For S-SYSTEM / S-ТИП	TORK VİDA / TORX SCREW / ВИНТЫ TORX
4006-M2.2x5	M2.2X0.45	5	6	2.8	55	S-SİSTEM için / For S-SYSTEM / S-ТИП	TORK VİDA / TORX SCREW / ВИНТЫ TORX
1008-M2.5x5	M2.5X0.45	5.5	8	3.5	45	S-SİSTEM için / For S-SYSTEM / S-ТИП	TORK VİDA / TORX SCREW / ВИНТЫ TORX
1008-M2.5x7	M2.5X0.45	7	8	3.6	45	S-SİSTEM için / For S-SYSTEM / S-ТИП	TORK VİDA / TORX SCREW / ВИНТЫ TORX
1108-M2.5x6	M2.5X0.45	6	8	3.9	R	S-SİSTEM için / For S-SYSTEM / S-ТИП	TORK VİDA / TORX SCREW / ВИНТЫ TORX
3008-M2.5x5	M2.5X0.45	5	8	3.5	60	S-SİSTEM için / For S-SYSTEM / S-ТИП	TORK VİDA / TORX SCREW / ВИНТЫ TORX
3008-M2.5x6	M2.5X0.45	6	8	3.5	60	S-SİSTEM için / For S-SYSTEM / S-ТИП	TORK VİDA / TORX SCREW / ВИНТЫ TORX
3008-M2.5X8	M2.5X0.45	8	8	3.5	50	S-SİSTEM için / For S-SYSTEM / S-ТИП	TORK VİDA / TORX SCREW / ВИНТЫ TORX
4008-M2.5x4	M2.5X0.45	4	8	3.5	45	S-SİSTEM için / For S-SYSTEM / S-ТИП	TORK VİDA / TORX SCREW / ВИНТЫ TORX
4008-M2.5x4.5	M2.5X0.45	4.5	8	3.5	45	S-SİSTEM için / For S-SYSTEM / S-ТИП	TORK VİDA / TORX SCREW / ВИНТЫ TORX
4008-M2.5x6	M2.5X0.45	5.8	8	3.5	45	S-SİSTEM için / For S-SYSTEM / S-ТИП	TORK VİDA / TORX SCREW / ВИНТЫ TORX
4008-M2.5x6.5	M2.5X0.45	6.5	8	4	60	S-SİSTEM için / For S-SYSTEM / S-ТИП	TORK VİDA / TORX SCREW / ВИНТЫ TORX
4108-M2.5x6.5	M2.5X0.45	6.5	8	3.5	50	S-SİSTEM için / For S-SYSTEM / S-ТИП	TORK VİDA / TORX SCREW / ВИНТЫ TORX
4108-M2.5x8	M2.5X0.45	8	8	3.5	50	S-SİSTEM için / For S-SYSTEM / S-ТИП	TORK VİDA / TORX SCREW / ВИНТЫ TORX
1008-M3x6	M3X0.5	6	8	4	60	S-SİSTEM için / For S-SYSTEM / S-ТИП	TORK VİDA / TORX SCREW / ВИНТЫ TORX
1008-M3x8	M3X0.5	8	8	3.9	60	S-SİSTEM için / For S-SYSTEM / S-ТИП	TORK VİDA / TORX SCREW / ВИНТЫ TORX
1108-M3x6.8	M3X0.5	6.8	8	4	60	S-SİSTEM için / For S-SYSTEM / S-ТИП	TORK VİDA / TORX SCREW / ВИНТЫ TORX
3008-M3x6	M3X0.5	6	8	4	45	S-SİSTEM için / For S-SYSTEM / S-ТИП	TORK VİDA / TORX SCREW / ВИНТЫ TORX
3008-M3x7	M3X0.5	7	8	4	55	S-SİSTEM için / For S-SYSTEM / S-ТИП	TORK VİDA / TORX SCREW / ВИНТЫ TORX
3008-M3x8	M3X0.5	8	8	4	45	S-SİSTEM için / For S-SYSTEM / S-ТИП	TORK VİDA / TORX SCREW / ВИНТЫ TORX
3108-M3x6	M3X0.5	6	8	3.8	60	S-SİSTEM için / For S-SYSTEM / S-ТИП	TORK VİDA / TORX SCREW / ВИНТЫ TORX
4008-M3x8	M3X0.5	8	8	4	60	S-SİSTEM için / For S-SYSTEM / S-ТИП	TORK VİDA / TORX SCREW / ВИНТЫ TORX
4010-M3x6	M3X0.5	6	10	4.2	45	S-SİSTEM için / For S-SYSTEM / S-ТИП	TORK VİDA / TORX SCREW / ВИНТЫ TORX
4010-M3x8	M3X0.5	8	10	4.2	45	S-SİSTEM için / For S-SYSTEM / S-ТИП	TORK VİDA / TORX SCREW / ВИНТЫ TORX
1015-M3.5x9	M3.5X0.6	9	15	5.3	60	S-SİSTEM için / For S-SYSTEM / S-ТИП	TORK VİDA / TORX SCREW / ВИНТЫ TORX
1015-M3.5x11	M3.5X0.6	11.1	15	5.3	60	S-SİSTEM için / For S-SYSTEM / S-ТИП	TORK VİDA / TORX SCREW / ВИНТЫ TORX
1015-M3.5x14	M3.5X0.6	14	15	5.3	66	S-SİSTEM için / For S-SYSTEM / S-ТИП	TORK VİDA / TORX SCREW / ВИНТЫ TORX
1015-M3.5x16	M3.5X0.6	16	15	5.3	55	S-SİSTEM için / For S-SYSTEM / S-ТИП	TORK VİDA / TORX SCREW / ВИНТЫ TORX
1315-M3.5x11	M3.5X0.6	10.6	15	7.9	-	S-SİSTEM için / For S-SYSTEM / S-ТИП	TORK VİDA / TORX SCREW / ВИНТЫ TORX
1510-M3.5x7	M3.5X0.6	7.1	10	5.1	55	S-SİSTEM için / For S-SYSTEM / S-ТИП	TORK VİDA / TORX SCREW / ВИНТЫ TORX
1510-M3.5x9	M3.5X0.6	9.1	10	5	55	S-SİSTEM için / For S-SYSTEM / S-ТИП	TORK VİDA / TORX SCREW / ВИНТЫ TORX
1615-M3.5x10	M3.5X0.6	10	15	5.8	60	S-SİSTEM için / For S-SYSTEM / S-ТИП	TORK VİDA / TORX SCREW / ВИНТЫ TORX
1615-M3.5x11	M3.5X0.6	11	15	5.8	60	S-SİSTEM için / For S-SYSTEM / S-ТИП	TORK VİDA / TORX SCREW / ВИНТЫ TORX
1615-M3.5x15	M3.5X0.6	15	15	5.8	60	S-SİSTEM için / For S-SYSTEM / S-ТИП	TORK VİDA / TORX SCREW / ВИНТЫ TORX
3010-M3.5x7	M3.5X0.6	7	10	5	55	S-SİSTEM için / For S-SYSTEM / S-ТИП	TORK VİDA / TORX SCREW / ВИНТЫ TORX
3010-M3.5x9	M3.5X0.6	9	10	5	55	S-SİSTEM için / For S-SYSTEM / S-ТИП	TORK VİDA / TORX SCREW / ВИНТЫ TORX
3015-M3.5x9	M3.5X0.6	8.8	15	5.4	60	S-SİSTEM için / For S-SYSTEM / S-ТИП	TORK VİDA / TORX SCREW / ВИНТЫ TORX
4015-M3.5x8	M3.5X0.6	7.9	15	5.3	55	S-SİSTEM için / For S-SYSTEM / S-ТИП	TORK VİDA / TORX SCREW / ВИНТЫ TORX
4015-M3.5x9	M3.5X0.6	8.7	15	5.3	60	S-SİSTEM için / For S-SYSTEM / S-ТИП	TORK VİDA / TORX SCREW / ВИНТЫ TORX
4015-M3.5x10	M3.5X0.6	9.8	15	5.3	60	S-SİSTEM için / For S-SYSTEM / S-ТИП	TORK VİDA / TORX SCREW / ВИНТЫ TORX

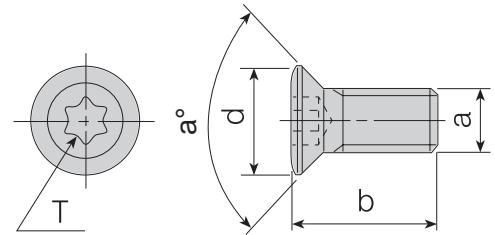

TORK VİDALARI / TORX SCREWS / ВИНТЫ TORX

Таким Kodu Ordering Code Код для заказа	a (M)	b	T	d	a°	Ürün Detayı / Product Detail / Описание	
4015-M3.5x11	M3.5X0.6	10.7	15	5.3	60	S-SİSTEM için / For S-SYSTEM / S-ТИП	TORK VİDA / TORX SCREW / ВИНТЫ TORX
4015-M3.5x12	M3.5X0.6	12	15	5.3	60	S-SİSTEM için / For S-SYSTEM / S-ТИП	TORK VİDA / TORX SCREW / ВИНТЫ TORX
4015-M3.5x14	M3.5X0.6	13.7	15	5.3	60	S-SİSTEM için / For S-SYSTEM / S-ТИП	TORK VİDA / TORX SCREW / ВИНТЫ TORX
1015-M4x8	M4X0.7	8	15	6.8	R	S-SİSTEM için / For S-SYSTEM / S-ТИП	TORK VİDA / TORX SCREW / ВИНТЫ TORX
1015-M4x9	M4X0.7	9	15	6.8	R	S-SİSTEM için / For S-SYSTEM / S-ТИП	TORK VİDA / TORX SCREW / ВИНТЫ TORX
1515-M4x9	M4X0.7	9	15	5.7	50	S-SİSTEM için / For S-SYSTEM / S-ТИП	TORK VİDA / TORX SCREW / ВИНТЫ TORX
1015-M4x11	M4X0.7	10.8	15	6.8	R	S-SİSTEM için / For S-SYSTEM / S-ТИП	TORK VİDA / TORX SCREW / ВИНТЫ TORX
1115-M4x10	M4X0.7	10	15	5.9	R	S-SİSTEM için / For S-SYSTEM / S-ТИП	TORK VİDA / TORX SCREW / ВИНТЫ TORX
1315-M4x11	M4X0.7	11.1	15	5	45	S-SİSTEM için / For S-SYSTEM / S-ТИП	TORK VİDA / TORX SCREW / ВИНТЫ TORX
1415-M4x11	M4X0.7	11	15	5.6	50	S-SİSTEM için / For S-SYSTEM / S-ТИП	TORK VİDA / TORX SCREW / ВИНТЫ TORX
1515-M4x11	M4X0.7	11.1	15	5.6	50	S-SİSTEM için / For S-SYSTEM / S-ТИП	TORK VİDA / TORX SCREW / ВИНТЫ TORX
1615-M4x11	M4X0.7	11.1	15	6	50	S-SİSTEM için / For S-SYSTEM / S-ТИП	TORK VİDA / TORX SCREW / ВИНТЫ TORX
3015-M4x9	M4X0.7	9	15	5.6	50	S-SİSTEM için / For S-SYSTEM / S-ТИП	TORK VİDA / TORX SCREW / ВИНТЫ TORX
3015-M4x11	M4X0.7	11	15	5.6	50	S-SİSTEM için / For S-SYSTEM / S-ТИП	TORK VİDA / TORX SCREW / ВИНТЫ TORX
4015-M4X8	M4X0.7	8	15	5.6	50	S-SİSTEM için / For S-SYSTEM / S-ТИП	TORK VİDA / TORX SCREW / ВИНТЫ TORX
4015-M4x9	M4X0.7	9	15	5.6	50	S-SİSTEM için / For S-SYSTEM / S-ТИП	TORK VİDA / TORX SCREW / ВИНТЫ TORX
4015-M4x10	M4X0.7	10	15	5.6	50	S-SİSTEM için / For S-SYSTEM / S-ТИП	TORK VİDA / TORX SCREW / ВИНТЫ TORX
4015-M4x11	M4X0.7	11	15	5.6	50	S-SİSTEM için / For S-SYSTEM / S-ТИП	TORK VİDA / TORX SCREW / ВИНТЫ TORX
4015-M4x12	M4X0.7	12	15	5.7	50	S-SİSTEM için / For S-SYSTEM / S-ТИП	TORK VİDA / TORX SCREW / ВИНТЫ TORX
4115-M4x12	M4X0.7	12	15	5.6	55	S-SİSTEM için / For S-SYSTEM / S-ТИП	TORK VİDA / TORX SCREW / ВИНТЫ TORX
4515-M4x8	M4X0.7	8	15	5.1	50	S-SİSTEM için / For S-SYSTEM / S-ТИП	TORK VİDA / TORX SCREW / ВИНТЫ TORX
4515-M4x11	M4X0.7	11	15	5.1	50	S-SİSTEM için / For S-SYSTEM / S-ТИП	TORK VİDA / TORX SCREW / ВИНТЫ TORX
4615-M4x11	M4X0.7	11	15	6	50	S-SİSTEM için / For S-SYSTEM / S-ТИП	TORK VİDA / TORX SCREW / ВИНТЫ TORX
1015-M4.5x12	M4.5X0.75	12	15	6.6	50	S-SİSTEM için / For S-SYSTEM / S-ТИП	TORK VİDA / TORX SCREW / ВИНТЫ TORX
1020-M4.5x14	M4.5X0.75	14	20	6.5	45	S-SİSTEM için / For S-SYSTEM / S-ТИП	TORK VİDA / TORX SCREW / ВИНТЫ TORX
1020-M4.5x16	M4.5X0.75	16	20	6.5	45	S-SİSTEM için / For S-SYSTEM / S-ТИП	TORK VİDA / TORX SCREW / ВИНТЫ TORX
1120-M4.5x12	M4.5X0.75	12.1	20	7.9	R	S-SİSTEM için / For S-SYSTEM / S-ТИП	TORK VİDA / TORX SCREW / ВИНТЫ TORX
1515-M4.5x11	M4.5X0.75	11	15	6.4	45	S-SİSTEM için / For S-SYSTEM / S-ТИП	TORK VİDA / TORX SCREW / ВИНТЫ TORX
4015-M4.5x11	M4.5X0.75	11	15	6.4	45	S-SİSTEM için / For S-SYSTEM / S-ТИП	TORK VİDA / TORX SCREW / ВИНТЫ TORX
4020-M4.5x10	M4.5X0.75	10	20	6.5	55	S-SİSTEM için / For S-SYSTEM / S-ТИП	TORK VİDA / TORX SCREW / ВИНТЫ TORX
4020-M4.5x12	M4.5X0.75	12	20	6.5	55	S-SİSTEM için / For S-SYSTEM / S-ТИП	TORK VİDA / TORX SCREW / ВИНТЫ TORX
1020-M5x7.5	M5X0.8	7.5	20	6.5	50	S-SİSTEM için / For S-SYSTEM / S-ТИП	TORK VİDA / TORX SCREW / ВИНТЫ TORX
1020-M5x11	M5X0.8	11	20	6.6	50	S-SİSTEM için / For S-SYSTEM / S-ТИП	TORK VİDA / TORX SCREW / ВИНТЫ TORX
1020-M5x14	M5X0.8	14.1	20	6.8	50	S-SİSTEM için / For S-SYSTEM / S-ТИП	TORK VİDA / TORX SCREW / ВИНТЫ TORX
1120-M5x13	M5X0.8	13	20	7	R	S-SİSTEM için / For S-SYSTEM / S-ТИП	TORK VİDA / TORX SCREW / ВИНТЫ TORX
1615-M5x14	M5X0.8	14	15	7.3	50	S-SİSTEM için / For S-SYSTEM / S-ТИП	TORK VİDA / TORX SCREW / ВИНТЫ TORX
1620-M5x18	M5X0.8	18	20	8.15	50	S-SİSTEM için / For S-SYSTEM / S-ТИП	TORK VİDA / TORX SCREW / ВИНТЫ TORX
1620-M5x22	M5X0.8	22	20	8.15	50	S-SİSTEM için / For S-SYSTEM / S-ТИП	TORK VİDA / TORX SCREW / ВИНТЫ TORX
4420-M5x14	M5X0.8	14	20	6.6	60	S-SİSTEM için / For S-SYSTEM / S-ТИП	TORK VİDA / TORX SCREW / ВИНТЫ TORX
1020-M6x16	M6X1.0	16	20	8.5	50	S-SİSTEM için / For S-SYSTEM / S-ТИП	TORK VİDA / TORX SCREW / ВИНТЫ TORX
1420-M6x16	M6X1.0	16	20	7.6	50	S-SİSTEM için / For S-SYSTEM / S-ТИП	TORK VİDA / TORX SCREW / ВИНТЫ TORX
1520-M6x16	M6X1.0	16	20	8.2	50	S-SİSTEM için / For S-SYSTEM / S-ТИП	TORK VİDA / TORX SCREW / ВИНТЫ TORX
1710-U5-40x12.2	UNC 5-40	12.2	10	5.6	60	S-SİSTEM için / For S-SYSTEM / S-ТИП	TORK VİDA / TORX SCREW / ВИНТЫ TORX
1720-U8-32x10	UNC 8-32	10	20	7.5	60	S-SİSTEM için / For S-SYSTEM / S-ТИП	TORK VİDA / TORX SCREW / ВИНТЫ TORX
1720-U8-32x15	UNC 8-32	15	20	7.5	60	S-SİSTEM için / For S-SYSTEM / S-ТИП	TORK VİDA / TORX SCREW / ВИНТЫ TORX
1707-U4-48x6	UNF 4-48	6	7	3.27	60	S-SİSTEM için / For S-SYSTEM / S-ТИП	TORK VİDA / TORX SCREW / ВИНТЫ TORX
1707-U4-48x6.5	UNF 4-48	6.5	7	3.27	60	S-SİSTEM için / For S-SYSTEM / S-ТИП	TORK VİDA / TORX SCREW / ВИНТЫ TORX
1707-U4-48x8.2	UNF 4-48	8.2	7	3.27	60	S-SİSTEM için / For S-SYSTEM / S-ТИП	TORK VİDA / TORX SCREW / ВИНТЫ TORX

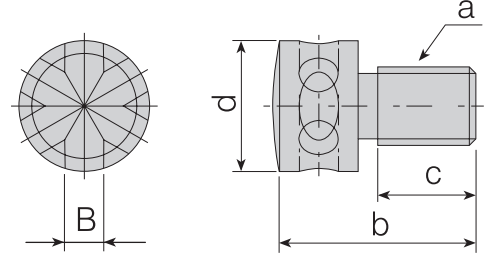

EKSENEL AYAR VIDALARI / AXIAL ADJUSTING SCREWS / ОСЕВОЙ РЕГУЛИРОВОЧНЫЙ ВИНТ

Takım Kodu Ordering Code Код для заказа	a (M)	b	c	d	B	Ürün Detayı / Product Detail / Описание
2600-M4x9.5	M4X0.5	5.5	4	4	1.5	Kartuş için / for Cartridge / Для картриджа Eksenel Ayar Vida / Axial Adjust Screw / Осевой регулировочный винт
2600-M5x13	M5x0.5	12.8	7	8.7	2.5	Kartuş için / for Cartridge / Для картриджа Eksenel Ayar Vida / Axial Adjust Screw / Осевой регулировочный винт
2600-M6x18	M6x1.0	18.2	9	10	3.5	Kartuş için / for Cartridge / Для картриджа Eksenel Ayar Vida / Axial Adjust Screw / Осевой регулировочный винт

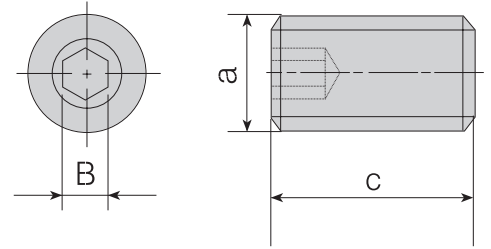
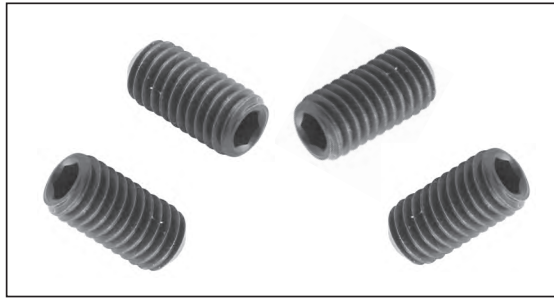

RADYAL AYAR VIDALARI / RADIAL ADJUSTING SCREWS / РЕГУЛИРОВОЧНЫЙ ВИНТ

Takım Kodu Ordering Code Код для заказа	a (M)	c	B	Ürün Detayı / Product Detail / Описание
2715-M3x4	M3x0.5	4	1.5	KABA BARA için / for ROUGH BORING HEADS РЕГУЛИРОВОЧНЫЙ ВИНТ РАСТОЧНОЙ ГОЛОВКИ KABA BARA KARTUŞU için / for ROUGH BORING HEADS CARTRIDGE
2715-M3x5	M3x0.5	5	1.5	РЕГУЛИРОВОЧНЫЙ ВИНТ РАСТОЧНОЙ ГОЛОВКИ KABA BARA KARTUŞU için / for ROUGH BORING HEADS CARTRIDGE
2715-M3x8	M3x0.5	8	1.5	РЕГУЛИРОВОЧНЫЙ ВИНТ РАСТОЧНОЙ ГОЛОВКИ KABA BARA KARTUŞU için / for ROUGH BORING HEADS CARTRIDGE
2702-M4x4	M4x0.7	4	2	KARTUŞ için / for CARTRIDGE / КАРТРИДЖИ РЕГУЛИРОВОЧНЫЙ ВИНТ РАСТОЧНОЙ ГОЛОВКИ
2702-M4x10	M4x0.7	10	2	KARTUŞ için / for CARTRIDGE / КАРТРИДЖИ РЕГУЛИРОВОЧНЫЙ ВИНТ РАСТОЧНОЙ ГОЛОВКИ
2702-M4x12	M4x0.7	12	2	KABA BARA için / for ROUGH BORING HEADS KABA BARA KARTUŞU için / for ROUGH BORING HEADS CARTRIDGE
2725-M5x6	M5x0.8	5	2.5	РЕГУЛИРОВОЧНЫЙ ВИНТ РАСТОЧНОЙ ГОЛОВКИ KARTUŞ için / for CARTRIDGE / КАРТРИДЖИ
2725-M5x10	M5x0.8	10	2.5	KARTUŞ için / for CARTRIDGE / КАРТРИДЖИ РЕГУЛИРОВОЧНЫЙ ВИНТ РАСТОЧНОЙ ГОЛОВКИ
2725-M5x12	M5x0.8	12	2.5	KABA BARA için / for ROUGH BORING HEADS KABA BARA KARTUŞU için / for ROUGH BORING HEADS CARTRIDGE
2725-M5x14	M5x0.8	14	2.5	РЕГУЛИРОВОЧНЫЙ ВИНТ РАСТОЧНОЙ ГОЛОВКИ KABA BARA KARTUŞU için / for ROUGH BORING HEADS CARTRIDGE
2703-M6x16	M6x1	16	3	KABA BARA için / for ROUGH BORING HEADS KABA BARA KARTUŞU için / for ROUGH BORING HEADS CARTRIDGE
2704-M8x25	M8x1.25	25.9	4	KABA BARA için / for ROUGH BORING HEADS KABA BARA KARTUŞU için / for ROUGH BORING HEADS CARTRIDGE
2704-M8x1x5	M8x1	5	4	İÇTEN SOĞUTMA KANALLI TAKIMLAR için / for COOLANT TOOLS / С ПОДВОДОМ СОЖ JET TAKIMLAR için / For JET TOOLS / Для Державок с подводом СОЖ
2705-G1/8x5.5	G1/8	5.5	5	İÇTEN SOĞUTMA KANALLI TAKIMLAR için / for COOLANT TOOLS / С ПОДВОДОМ СОЖ JET TAKIMLAR için / For JET TOOLS / Для Державок с подводом СОЖ

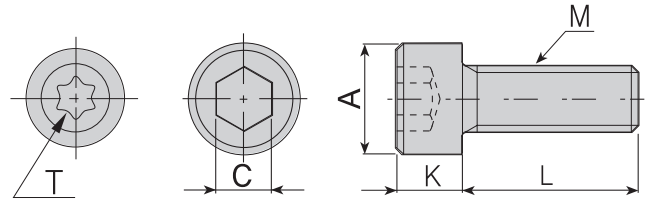

İNBUS CİVATALAR / INBUS SCREWS / ВИНТЫ С ПОТАЙНОЙ ГОЛОВКОЙ

Takım Kodu Ordering Code Код для заказа	M	A	C	K	L	Ürün Detayı / Product Detail / Описание	
						Ürün Detayı / Product Detail / Описание	Ürün Detayı / Product Detail / Описание
2503-M4x10	M4x0.7	6.85	3	4	10	KANAL KATER VİDASI / SOME GROOVING TOOLS SCREW	ДЛЯ НЕКОТОРЫХ КАНАВОЧНЫХ ДЕРЖАВОК
2525-M3X14	M3X0.5	5.4	2.5	2.9	14	BARA KARTUŞU için SIKMA VİDASI / for BORING HEADS CARTRIDGE SCREW	ВИНТ ДЛЯ КАРТРИДЖЕЙ РАСТОЧНЫХ ГОЛОВОК
2503-M4X20	M4x0.7	7	3	3.9	20	BARA KARTUŞU için SIKMA VİDASI / for BORING HEADS CARTRIDGE SCREW	ВИНТ ДЛЯ КАРТРИДЖЕЙ РАСТОЧНЫХ ГОЛОВОК
2503-M4X12	M4x0.7	6.85	3	4	12	KANAL KATER VİDASI / SOME GROOVING TOOLS SCREW	ДЛЯ НЕКОТОРЫХ КАНАВОЧНЫХ ДЕРЖАВОК
2503-M4X15	M4x0.7	6.85	3	4	15	BARA KARTUŞU için SIKMA VİDASI / for BORING HEADS CARTRIDGE SCREW	ВИНТ ДЛЯ КАРТРИДЖЕЙ РАСТОЧНЫХ ГОЛОВОК
2504-M5X16	M5X0.8	8.5	4	5	16	KANAL KATER VİDASI / SOME GROOVING TOOLS SCREW	ДЛЯ НЕКОТОРЫХ КАНАВОЧНЫХ ДЕРЖАВОК
2504-M5X12	M5X0.8	8.5	4	5	12	KANAL KATER VİDASI / SOME GROOVING TOOLS SCREW	ДЛЯ НЕКОТОРЫХ КАНАВОЧНЫХ ДЕРЖАВОК
2504-M5X25	M5X0.8	8.5	4	5	25	BARA KARTUŞU için SIKMA VİDASI / for BORING HEADS CARTRIDGE SCREW	ВИНТ ДЛЯ КАРТРИДЖЕЙ РАСТОЧНЫХ ГОЛОВОК
2505-M6X16	M6X1	9.9	5	6	16	KANAL KATER VİDASI / SOME GROOVING TOOLS SCREW	ДЛЯ НЕКОТОРЫХ КАНАВОЧНЫХ ДЕРЖАВОК
2505-M6X20	M6X1	9.9	5	6	20	KANAL KATER VİDASI / SOME GROOVING TOOLS SCREW	ДЛЯ НЕКОТОРЫХ КАНАВОЧНЫХ ДЕРЖАВОК
2505-M6X25	M6X1	9.9	5	6	25	BLOK BASKI PABUÇ VİDASI / for BLOCK CLAMP SCREW	ВИНТ ДЛЯ ПРИЖИМА БЛОКОВ
2505-M6X30	M6X1	9.9	5	6	30	BARA KARTUŞU için SIKMA VİDASI / for BORING HEADS CARTRIDGE SCREW	ВИНТ ДЛЯ КАРТРИДЖЕЙ РАСТОЧНЫХ ГОЛОВОК
2306-M8X37	M8X1.25	13	6	6.4	31.5	MONTAJ VİDASI (KAFASI KÜÇÜK) / MOUNTING SCREW (SMALL HEAD)	МОНТАЖНЫЙ ВИНТ (МАЛЕНЬКАЯ ГОЛОВКА)
2405-M8X30	M8X1.25	13	5	5	30	A16 MONTAJ VİDASI (KAFASI KÜÇÜK) / MOUNTING SCREW (SMALL HEAD)	МОНТАЖНЫЙ ВИНТ (МАЛЕНЬКАЯ ГОЛОВКА)
2506-M8X20	M8X1.25	13	6	7.9	20	KARTUŞ MONTAJ VİDASI / CARTRIDGE MOUNTING SCREW	МОНТАЖНЫЙ ВИНТ ДЛЯ КАРТРИДЖА
2506-M8X30	M8X1.25	13	6	7.9	30	A16 MONTAJ VİDASI / MOUNTING SCREW	МОНТАЖНЫЙ ВИНТ (МАЛЕНЬКАЯ ГОЛОВКА)
2506-M8X35	M8X1.25	13	6	7.9	35	BARA KARTUŞU için SIKMA VİDASI / for BORING HEADS CARTRIDGE SCREW	ВИНТ ДЛЯ КАРТРИДЖЕЙ РАСТОЧНЫХ ГОЛОВОК
2406-M8X30	M8X1.25	12	6	7.9	30	A16 MONTAJ VİDASI / MOUNTING SCREW	МОНТАЖНЫЙ ВИНТ (МАЛЕНЬКАЯ ГОЛОВКА)
2407-M10X30	M10X1.5	16	7	6	30	A16 MONTAJ VİDASI / MOUNTING SCREW	МОНТАЖНЫЙ ВИНТ (МАЛЕНЬКАЯ ГОЛОВКА)
2408-M10X30	M10X1.5	13	8	10	30	A22 MONTAJ VİDASI / MOUNTING SCREW	МОНТАЖНЫЙ ВИНТ (МАЛЕНЬКАЯ ГОЛОВКА)
2508-M10X30	M10X1.5	16	8	10	30	A22 MONTAJ VİDASI / MOUNTING SCREW	МОНТАЖНЫЙ ВИНТ (МАЛЕНЬКАЯ ГОЛОВКА)
2508-M10X40	M10X1.5	16	8	10	40	BARA KARTUŞU için SIKMA VİDASI / for BORING HEADS CARTRIDGE SCREWS	ВИНТ ДЛЯ КАРТРИДЖЕЙ РАСТОЧНЫХ ГОЛОВОК
2408-M12X35	M12X1.75	18	8	7	35	A27 MONTAJ VİDASI / MOUNTING SCREW	МОНТАЖНЫЙ ВИНТ (МАЛЕНЬКАЯ ГОЛОВКА)
2510-M12X35	M12X1.75	18	10	12	35	A27 MONTAJ VİDASI / MOUNTING SCREW	МОНТАЖНЫЙ ВИНТ (МАЛЕНЬКАЯ ГОЛОВКА)
2514-M16X35	M16X2.0	23.7	14	16	35	A32 MONTAJ VİDASI / MOUNTING SCREW	МОНТАЖНЫЙ ВИНТ (МАЛЕНЬКАЯ ГОЛОВКА)
AAV-11-U5-40x4.5	UNC 5-40	5.4	T10	2.8	4.5	16 ER/L, 16 IR/L ALTLIK VİDASI / SHIM SCREW	Винт опорной пластины
AAV-12-U8-32x5.5	UNC 8-32	6.7	T20	3.8	5.5	22 ER/L, 22 IR/L ALTLIK VİDASI / SHIM SCREW	Винт опорной пластины
AAV-15-M5x5.7	M5X0.8	8.5	T20	3.15	5.7	27 ER/L, 27 IR/L ALTLIK VİDASI / SHIM SCREW	Винт опорной пластины

SEKMAN / RING / КОЛЬЦО

Ürün Resmi Product Picture Изображение	Ürün Kodu Product Code / Код	Ürün Detayı / Product Detail / Описание	
		ACS-01	C-SİSTEM için / For C-SYSTEM / C-ТИП
AS-01		T-M-SİSTEM için / For T-M-SYSTEM / T-M ТИП	AKV-30-M6x22 SEKMANI / КОЛЬЦО
AS-02		T SİSTEM için / For T SYSTEM / TТИП	AKV-19-M7x25 SEKMANI / КОЛЬЦО

ORING / ORING / КОЛЬЦО

Ürün Resmi Product Picture Изображение	ORING / ORING / КОЛЬЦО		
	Ürün Kodu Product Code / Код	Ürün Detayı / Product Detail / Описание	
	AOR-01	P-SİSTEM için / For P-SYSTEM / P-ТИП	
	AXR-01	T-P SİSTEM için / For T-P SYSTEM / T-P-ТИП	

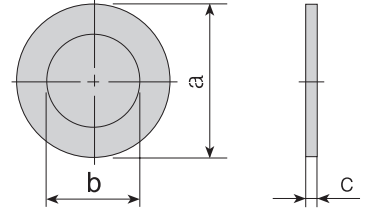
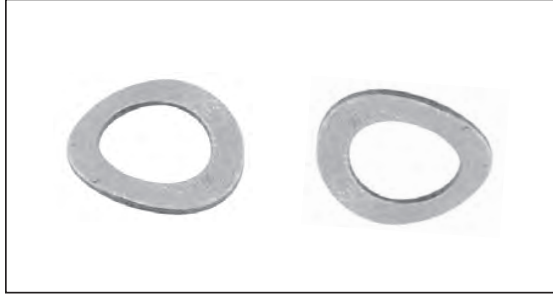

BASKI VE ALTLIK VİDASI PULU / STAMP / ШАЙБА

Takım Kodu Ordering Code Код для заказа	a	b	c	Ürün Detayı / Product Detail / Описание	
				PUL/STAMP/ШАЙБА	BASKI PULU / STAMP / ШАЙБА
ABPL-01	10.5	6.2	0.5	PUL/STAMP/ШАЙБА	BASKI PULU / STAMP / ШАЙБА
ABPL-02	12.75	7.1	0.45	PUL/STAMP/ШАЙБА	BASKI PULU / STAMP / ШАЙБА
ABPL-03	5.3	3.2	0.5	PUL/STAMP/ШАЙБА	TER - TIR 16 ER/EL - IR/İL ALTLIK VİDA PULU / SHIM SCREW RING / ВИНТ ОПОРНОЙ ПЛАСТИНЫ
ABPL-04	6.9	4.2	0.5	PUL/STAMP/ШАЙБА	TER - TIR 22 ER/EL - IR/İL ALTLIK VİDA PULU / SHIM SCREW RING / ВИНТ ОПОРНОЙ ПЛАСТИНЫ
ABPL-05	8.5	5	0.5	PUL/STAMP/ШАЙБА	TER - TIR 27 ER/EL - IR/İL ALTLIK VİDA PULU / SHIM SCREW RING / ВИНТ ОПОРНОЙ ПЛАСТИНЫ

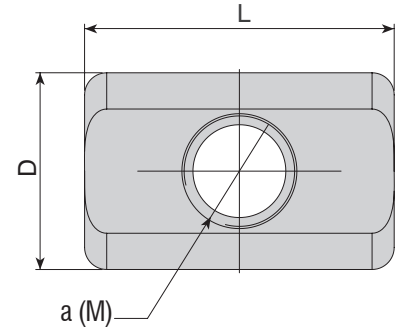

BARA PABUÇLARI / BORING HEADS CARTRIDGE / КАРТРИДЖЕЙ РАСТОЧНЫХ ГОЛОВОК

Takım Kodu Ordering Code Код для заказа	a (M)	D	L	Ürün Detayı / Product Detail / Описание	
				KABA BARA için / for ROUGH BORING HEADS / ДЛЯ ЧЕРНОВЫХ РАСТОЧНЫХ ГОЛОВОК	ABHR-D16x42-W16-L90
ABKS-D16	M3x0.5	4.9	6	KABA BARA için / for ROUGH BORING HEADS / ДЛЯ ЧЕРНОВЫХ РАСТОЧНЫХ ГОЛОВОК	ABHR-D16x42-W16-L90
ABKS-D20	M4x0.7	5.9	9	ABA BARA için / for ROUGH BORING HEADS / ДЛЯ ЧЕРНОВЫХ РАСТОЧНЫХ ГОЛОВОК	ABHR-D20x50-W20-L100
ABKS-D25	M4x0.7	5.9	12	KABA BARA için / for ROUGH BORING HEADS / ДЛЯ ЧЕРНОВЫХ РАСТОЧНЫХ ГОЛОВОК	ABHR-D25x60-W20-L110
ABKS-D32	M5x0.8	8.9	14	KABA BARA için / for ROUGH BORING HEADS / ДЛЯ ЧЕРНОВЫХ РАСТОЧНЫХ ГОЛОВОК	ABHR-D32x64-W25-L120
ABKS-D40	M6x1	10.9	18	KABA BARA için / for ROUGH BORING HEADS / ДЛЯ ЧЕРНОВЫХ РАСТОЧНЫХ ГОЛОВОК	ABHR-D40x80-W32-L140
ABKS-D50	M8x1.25	13.9	28	KABA BARA için / for ROUGH BORING HEADS / ДЛЯ ЧЕРНОВЫХ РАСТОЧНЫХ ГОЛОВОК	ABHR-D50x100-W32-L160
ABKS-D63	M10x1.5	15.9	35	KABA BARA için / for ROUGH BORING HEADS / ДЛЯ ЧЕРНОВЫХ РАСТОЧНЫХ ГОЛОВОК	ABHR-D63x80-W32-L140, ABHR-D63x130-W40-L200
ABKS-D80	M12x1.75	17.9	45	KABA BARA için / for ROUGH BORING HEADS / ДЛЯ ЧЕРНОВЫХ РАСТОЧНЫХ ГОЛОВОК	ABHR-D80x140-W40-L210, ABHR-D80x140-W40-L210-B



Ürün Resmi Product Picture Изображение	KESME ve KANAL LAMA AÇMA BLOK PABUÇLARI / BLOCKS FOR PARTING AND DEEP GROOVING BLADES CLAMPS ПРИЖИМ БЛОКА СМЕННОГО ЛЕЗВИЯ ДЛЯ ОТРЕЗКИ И ОБРАБОТКИ ГЛУБОКИХ КАНАВОК		
	Ürün Kodu Product Code / Код	Ürün Detayı / Product Detail / Описание	
	ABK-01	LAMA BLOĞU için / For BLADE BLOCK / ДЛЯ БЛОКА СМЕННОГО ЛЕЗВИЯ	ALBU-20-26 BASKI PABUCU / CLAMP / Прижим
	ABK-02	LAMA BLOĞU için / For BLADE BLOCK / ДЛЯ БЛОКА СМЕННОГО ЛЕЗВИЯ	ALBU-25-26 BASKI PABUCU / CLAMP / Прижим
	ABK-03	LAMA BLOĞU için / For BLADE BLOCK / ДЛЯ БЛОКА СМЕННОГО ЛЕЗВИЯ	ALBU-20-32 BASKI PABUCU / CLAMP / Прижим
	ABK-04	LAMA BLOĞU için / For BLADE BLOCK / ДЛЯ БЛОКА СМЕННОГО ЛЕЗВИЯ	ALBU-25-32, ALBU-32-32 BASKI PABUCU / CLAMP / Прижим

Ürün Resmi Product Picture Изображение	LAMA ANAHTARI / BLADE KEY / КЛЮЧ ДЛЯ ОТРЕЗНОГО НОЖА	
	Ürün Kodu Product Code / Код	Ürün Detayı / Product Detail / Описание
	ALA-01	AKL LAMA ANAHTARI / for BLADE KEY / КЛЮЧ ДЛЯ ОТРЕЗНОГО НОЖА
	ALA-02	AKL LAMA ANAHTARI / for BLADE KEY / КЛЮЧ ДЛЯ ОТРЕЗНОГО НОЖА

Ürün Resmi Product Picture Изображение	ALYAN ANAHTARLARI / ALLEN KEYS / ШЕСТИГРАННЫЕ КЛЮЧИ		
	Ürün Kodu Product Code / Код	Ürün Detayı / Product Detail / Описание	
	AAL-01-2	2 mm	ALYAN ANAHTARI / ALLEN KEYS / ШЕСТИГРАННЫЕ КЛЮЧИ
	AAL-02-2.5	2.5 mm	ALYAN ANAHTARI / ALLEN KEYS / ШЕСТИГРАННЫЕ КЛЮЧИ
	AAL-03-3	3 mm	ALYAN ANAHTARI / ALLEN KEYS / ШЕСТИГРАННЫЕ КЛЮЧИ
	AAL-05-4	4 mm	ALYAN ANAHTARI / ALLEN KEYS / ШЕСТИГРАННЫЕ КЛЮЧИ
	AAL-07-5	5 mm	ALYAN ANAHTARI / ALLEN KEYS / ШЕСТИГРАННЫЕ КЛЮЧИ
	AAL-08-6	6 mm	ALYAN ANAHTARI / ALLEN KEYS / ШЕСТИГРАННЫЕ КЛЮЧИ
	AAL-09-1.5	1.5 mm	ALYAN ANAHTARI / ALLEN KEYS / ШЕСТИГРАННЫЕ КЛЮЧИ
	AAL-11-8	8 mm	ALYAN ANAHTARI / ALLEN KEYS / ШЕСТИГРАННЫЕ КЛЮЧИ
	AAL-12-10	10 mm	ALYAN ANAHTARI / ALLEN KEYS / ШЕСТИГРАННЫЕ КЛЮЧИ

Ürün Resmi Product Picture Изображение	TORK ANAHTARLARI / TORX KEYS / Торх Ключ	
	Ürün Kodu Product Code / Код	Ürün Detayı / Product Detail / Описание
	80-T06	T06 TORK ANAHTARI / TORX KEY / Торх Ключ
	80-T07	T07 TORK ANAHTARI / TORX KEY / Торх Ключ
	80-T08	T08 TORK ANAHTARI / TORX KEY / Торх Ключ
	80-T10	T10 TORK ANAHTARI / TORX KEY / Торх Ключ
	80-T15	T15 TORK ANAHTARI / TORX KEY / Торх Ключ
	80-T20	T20 TORK ANAHTARI / TORX KEY / Торх Ключ
	81-T15	T15 T-TİP TORK ANAHTARI / T-TYPE TORX KEY / T-TYP-Tорх Ключ
	81-T20	T20 T-TİP TORK ANAHTARI / T-TYPE TORX KEY / T-TYP-Tорх Ключ

KOD / CODE	AÇIKLAMA / DESCRIPTION	СОДЕРЖАНИЕ	S.N. / P.N. СТР.
A/PTFNR/L ..	Boring Bars	Расточных Державок	108
A/SCLCR/L ..	Boring Bars SET	Наборы Расточных Державок	127
A/SDUCR/L ..	Boring Bars SET	Наборы Расточных Державок	128
AAKT-IG-R/L ..	Face External Grooving Tool Holders	Державки для Обработки Торцевых Канавок	179
AAKT-KG-R/L ..	Face External Grooving Tool Holders	Державки для Обработки Торцевых Канавок	178
AAKT-K-R/L ..	Face External Grooving Tool Holders	Державки для Обработки Торцевых Канавок	177
AAKT-ZCC2-R/L ..	Face External Grooving Tool Holders	Державки для Обработки Торцевых Канавок	178
AAUT-T20-R/L	Corner Reliefs Grooving Toolholders	Используйте резы серии AAUT-T20R...	16
ABHR ..	Adjustable Rough Boring Heads	Регулируемые Расточные Головки для Чернового Точения	237
ABHRS ..	Adjustable Rough Boring Heads Body	Корпус Регулируемой Расточной Головки для Чернового Точения	238
ABT-B4..	Broaching Toolholders	Долбяки с СМП	18
ACBM ..	Countersink Open Milling Tools	Зенковка для Отверстий	245
ACM ..	Chamfering End Mills	Концевые Фрезы Для Снятия Фаски (Зенковки)	243
ACM45-SP..	Chamfering End Mills	Концевые Фрезы Для Снятия Фаски (Зенковки)	244
ACPBT-..	Pipe Beveling Tools	Торцевочная Головка для Цилиндрических Заготовок	147
ADCR	Drill Chamfering Ring Tools	Кольца для Снятия Фаски	228
ADKT-123-R/L ..	External Grooving Tool Holders	Державки для Обработки Наружных Канавок	165
ADKT-151.22-R/L ..	External Grooving Tool Holders	Державки для Обработки Наружных Канавок	166
ADKT-151.23-R/L ..	External Grooving Tool Holders	Державки для Обработки Наружных Канавок	166
ADKT-154.91-R/L ..	External Grooving Tool Holders	Державки для Обработки Наружных Канавок	167
ADKT-ARN-R/L ..	External Grooving Tool Holders	Державки для Обработки Наружных Канавок	167
ADKT-CD-R/L ..	External Grooving Tool Holders	Державки для Обработки Наружных Канавок	172
ADKT-GP-R/L ..	External Grooving Tool Holders	Державки для Обработки Наружных Канавок	171
ADKT-H22-R/L ..	External Grooving Tool Holders	Державки для Обработки Наружных Канавок	170
ADKT-HK-R/L ..	External Grooving Tool Holders	Державки для Обработки Наружных Канавок	161
ADKT-H-R/L ..	External Grooving Tool Holders	Державки для Обработки Наружных Канавок	160
ADKT-HS223-R/L ..	External Grooving Tool Holders	Державки для Обработки Наружных Канавок	160
ADKT-IDC-R/L ..	External Grooving Tool Holders	Державки для Обработки Наружных Канавок	164
ADKT-IGI-R/L ..	External Grooving Tool Holders	Державки для Обработки Наружных Канавок	164
ADKT-IG-R/L ..	External Grooving Tool Holders	Державки для Обработки Наружных Канавок	164
ADKT-IGTN-R/L ..	External Grooving Tool Holders	Державки для Обработки Наружных Канавок	164
ADKT-I-R/L ..	External Grooving Tool Holders	Державки для Обработки Наружных Канавок	164
ADKT-I-R/L ..S	External Grooving (Swiss Type) Tool Holders	Державки для Обработки Наружных Канавок для Токарных Станков Швейцарского Типа	174
ADKT-ITG-R/L ..	External Grooving Tool Holders	Державки для Обработки Наружных Канавок	163
ADKT-KG-R/L ..	External Grooving Tool Holders	Державки для Обработки Наружных Канавок	159
ADKT-KG-R/L ..S	External Grooving (Swiss Type) Tool Holders	Державки для Обработки Наружных Канавок для Токарных Станков Швейцарского Типа	175
ADKT-KM-R/L ..	External Grooving Tool Holders	Державки для Обработки Наружных Канавок	163
ADKT-K-R/L ..	External Grooving Tool Holders	Державки для Обработки Наружных Канавок	158
ADKT-K-R/L ..-H	External Grooving Tool Holders With Coolant Tools	Externe Nutwerkzeughalter Mit Kühlwerkzeug	185
ADKT-K-R/L ..S	External Grooving (Swiss Type) Tool Holders	Державки для Обработки Наружных Канавок для Токарных Станков Швейцарского Типа	175
ADKT-LGC-R/L ..	External Grooving Tool Holders	Державки для Обработки Наружных Канавок	169
ADKT-RD-R/L ..	External Grooving Tool Holders	Державки для Обработки Наружных Канавок	169
ADKT-RD-R/L ..-S	External Grooving (Swiss Type) Tool Holders	Державки для Обработки Наружных Канавок для Токарных Станков Швейцарского Типа	173

KOD / CODE	AÇIKLAMA / DESCRIPTION	СОДЕРЖАНИЕ	S.N. / P.N. СТР.
ADKT-SGC-R/L ..	External Grooving Tool Holders	Державки для Обработки Наружных Канавок	160
ADKT-SWC-R/L ..	External Grooving Tool Holders	Державки для Обработки Наружных Канавок	172
ADKT-T12P-R/L	Poly-V Grooving Toolholders	POLY-V Инструмент для обработки канавок под клиновые ремни	12
ADKT-TD-R/L ..	External Grooving Tool Holders	Державки для Обработки Наружных Канавок	168
ADKT-TD-R/L ..S	External Grooving (Swiss Type) Tool Holders	Корпус Регулируемой Расточной Головки для Чернового Точения	173
ADKT-TD-R/L...H	External Grooving Tool Holders With Coolant Tools	Externe Nutwerkzeughalter Mit Kühlwerkzeug	185
ADKT-TG-R/L ..	External Grooving Tool Holders	Державки для Обработки Наружных Канавок	170
ADKT-TG-R/L ..-S	External Grooving (Swiss Type) Tool Holders	Корпус Регулируемой Расточной Головки для Чернового Точения	176
ADKT-WGX..-R/L ..	External Grooving Tool Holders	Державки для Обработки Наружных Канавок	171
ADKT-WGX..-R/L ..S	External Grooving (Swiss Type) Tool Holders	Корпус Регулируемой Расточной Головки для Чернового Точения	176
ADKT-ZCC1-R/L ..	External Grooving Tool Holders	Державки для Обработки Наружных Канавок	161
ADKT-ZCC2-R/L ..	External Grooving Tool Holders	Державки для Обработки Наружных Канавок	162
ADKT-ZCC2-R/L ..S	External Grooving (Swiss Type) Tool Holders	Корпус Регулируемой Расточной Головки для Чернового Точения	174
AEKR/L ..	Economic Cutting Tools	MULTI TOOL - Сверление	234
AEM90-3P..	End Mills	Концевые Фрезы	270
AEM90-3P..	Modular End Mills	Сменные Фрезерные Головки (Крепление под Резьбу)	291
AEM90-4N..	End Mills	Концевые Фрезы	271
AEM90-AD..	End Mills	Концевые Фрезы	246-247-248
AEM90-AD..	Modular End Mills	Сменные Фрезерные Головки (Крепление под Резьбу)	286
AEM90-AN..	End Mills	Концевые Фрезы	248-249
AEM90-AO..	End Mills	Концевые Фрезы	255
AEM90-AO..	Modular End Mills	Сменные Фрезерные Головки (Крепление под Резьбу)	285
AEM90-AP..	End Mills	Концевые Фрезы	250-251-252-253-254-255
AEM90-AP..	Modular End Mills	Сменные Фрезерные Головки (Крепление под Резьбу)	287
AEM90-AX..	End Mills	Концевые Фрезы	256-257
AEM90-AX..	Modular End Mills	Сменные Фрезерные Головки (Крепление под Резьбу)	286
AEM90-AZ..	End Mills	Концевые Фрезы	258
AEM90-BD..	End Mills	Концевые Фрезы	259
AEM90-BD..-H	Modular End Mills (Screw Type Tools)	Сменные Фрезерные Головки (Крепление под Резьбу)	288
AEM90-DC..	Modular End Mills	Сменные Фрезерные Головки (Крепление под Резьбу)	288
AEM90-ED..	End Mills	Концевые Фрезы	260
AEM90-LN..	End Mills	Концевые Фрезы	260-261-262
AEM90-R390..	End Mills	Концевые Фрезы	262
AEM90-R390..	Modular End Mills	Сменные Фрезерные Головки (Крепление под Резьбу)	289
AEM90-RT..	End Mills	Концевые Фрезы	263
AEM90-RT..	Modular End Mills	Сменные Фрезерные Головки (Крепление под Резьбу)	289
AEM90-SE..	End Mills	Концевые Фрезы	264
AEM90-SO..	End Mills	Концевые Фрезы	264
AEM90-SPGT..	End Mills	Концевые Фрезы	265
AEM90-TNG..	End Mills	Концевые Фрезы	265
AEM90-TNG..-H	Modular End Mills (Screw Type Tools)	Сменные Фрезерные Головки (Крепление под Резьбу)	290
AEM90-VC2205..-H	End Mills	Концевые Фрезы	266

KOD / CODE	AÇIKLAMA / DESCRIPTION	СОДЕРЖАНИЕ	SN. / PN. СТР.	KOD / CODE	AÇIKLAMA / DESCRIPTION	СОДЕРЖАНИЕ	SN. / PN. СТР.
AEM90-WN..	End Mills	Концевые Фрезы	267	AFM90-3P..	Face Milling	Торцевые Фрезы	346
AEM90-WN..	Modular End Mills	Сменные Фрезерные Головки (Крепление под Резьбу)	290	AFM90-490..	Face Milling	Торцевые Фрезы	338
AEM90-WNG.. -H	End Mills	Концевые Фрезы	266	AFM90-4N..	Face Milling	Торцевые Фрезы	346
AEM90-XC..	End Mills	Концевые Фрезы	268	AFM90-AD..	Face Milling	Торцевые Фрезы	324-325
AEM90-XD..	End Mills	Концевые Фрезы	267	AFM90-AN..	Face Milling	Торцевые Фрезы	327-328-329
AEM90-XN..	End Mills	Концевые Фрезы	269	AFM90-AO..	Face Milling	Торцевые Фрезы	329
AEM90-XO..	End Mills	Концевые Фрезы	268	AFM90-AP..	Face Milling	Торцевые Фрезы	330-331
AEM90-ZC..	End Mills	Концевые Фрезы	269	AFM90-AX..	Face Milling	Торцевые Фрезы	331
AEM90-ZP..	End Mills	Концевые Фрезы	270	AFM90-BD..	Face Milling	Торцевые Фрезы	332
AEM95(C)-XD..	Modular End Mills	Сменные Фрезерные Головки (Крепление под Резьбу)	291	AFM90C-TP..	Face Milling	Торцевые Фрезы	353
AEMR(C)-RD..	Face and Copy End Mills	Концевые Радиусные Фрезы	271	AFM90-LO..	Face Milling	Торцевые Фрезы	335-336
AEMR-QP..	Face and Copy Mills	Концевые Радиусные Фрезы	274	AFM90-R290..	Face Milling	Торцевые Фрезы	337
AEMR-QP..	Modular End Mills	Сменные Фрезерные Головки (Крепление под Резьбу)	295	AFM90-R390..	Face Milling	Торцевые Фрезы	337
AEMR-RC..	Modular End Mills	Сменные Фрезерные Головки (Крепление под Резьбу)	292	AFM90-RT..	Face Milling	Торцевые Фрезы	338
AEMR-RD..	Face and Copy Mills	Концевые Радиусные Фрезы	273	AFM90-SE..	Face Milling	Торцевые Фрезы	340
AEMR-RD..	Modular End Mills	Сменные Фрезерные Головки (Крепление под Резьбу)	294	AFM90-SP..	Face Milling	Торцевые Фрезы	341
AEMR-RP..	Face and Copy Mills	Концевые Радиусные Фрезы	271-272	AFM90-TN..	Face Milling	Торцевые Фрезы	342
AEMR-RP..	Modular End Mills	Сменные Фрезерные Головки (Крепление под Резьбу)	292-293	AFM90-TP..	Face Milling	Торцевые Фрезы	342
AEMR-RY..	Face and Copy End Mills	Концевые Радиусные Фрезы	272	AFM90-VC2205.. -H	Face Milling	Торцевые Фрезы	343
AEMR-RY..	Modular End Mills	Сменные Фрезерные Головки (Крепление под Резьбу)	293	AFM90-WN..	Face Milling	Торцевые Фрезы	344
AET	Eccentric Adaptor For U-Drill	Эксцентриский Адаптер для Сверл	230	AFM90-WNG0.. -H	Face Milling	Торцевые Фрезы	343
AFM42C-XD..	Face Milling	Торцевые Фрезы	312	AFM90-XN..	Face Milling	Торцевые Фрезы	345
AFM43(C)-OD..	Face Milling	Торцевые Фрезы	312-313	AFM90-XO..	Face Milling	Торцевые Фрезы	345
AFM43(C)-OF..	Face Milling	Торцевые Фрезы	313-351	AFMR(C)-RD..	Face and Copy Milling	Торцевые и Копировальные Фрезы	348
AFM43-ON..	Face Milling	Торцевые Фрезы	314	AFMR-QP..	Face and Copy Milling	Торцевые и Копировальные Фрезы	350
AFM44-ON..	Face Milling	Торцевые Фрезы	314	AFMR-RC..	Face and Copy Milling	Торцевые и Копировальные Фрезы	347
AFM45(L)-HN..	Face Milling	Торцевые Фрезы	315	AFMR-RP..	Face and Copy Milling	Торцевые и Копировальные Фрезы	349
AFM45(L)-SE..	Face Milling	Торцевые Фрезы	316-317	AFMR-RY..	Face and Copy Milling	Торцевые и Копировальные Фрезы	350
AFM45(S)-SE	Face Milling	Торцевые Фрезы	316	AHFM(C)-JD..	High Feed Milling Tools	Высокопроизводительные Торцевые Фрезы	357
AFM45C(L)-HN..	Face Milling	Торцевые Фрезы	351	AHFM(C)-SD..	High Feed End Mills	Высокопроизводительные Концевые Фрезы	280
AFM45C(L)-SN..	Face Milling	Торцевые Фрезы	317-318-319	AHFM(C)-SD..	High Feed Milling Tools	Высокопроизводительные Торцевые Фрезы	358
AFM45C-ON..	Face Milling	Торцевые Фрезы	320	AHFM(C)-SD..	Modular High Feed End Mills	Hochvorschubeinschraubfräser	300
AFM45C-XN..	Face Milling	Торцевые Фрезы	352	AHFM(C)-WD..	High Feed End Mills	Высокопроизводительные Концевые Фрезы	283-284
AFM45-NN..	Face Milling	Торцевые Фрезы	315	AHFM(C)-WD..	High Feed Milling Tools	Высокопроизводительные Торцевые Фрезы	360
AFM45-ON..	Face Milling	Торцевые Фрезы	319	AHFM(L)-WN..	High Feed Milling Tools	Высокопроизводительные Торцевые Фрезы	361
AFM45-SA..	Face Milling	Торцевые Фрезы	318	AHFM-BL..	High Feed End Mills	Высокопроизводительные Концевые Фрезы	276
AFM45-XN..	Face Milling	Торцевые Фрезы	320	AHFM-BL..	High Feed Milling Tools	Высокопроизводительные Торцевые Фрезы	354
AFM66-PN..	Face Milling	Торцевые Фрезы	321	AHFM-BL..	Modular High Feed End Mills	Высокопроизводительные Сменные Фрезерные Головки	295
AFM67-PN..	Face Milling	Торцевые Фрезы	321	AHFM-BN..	High Feed End Mills	Высокопроизводительные Концевые Фрезы	274
AFM75-AP..	Face Milling	Торцевые Фрезы	322	AHFMC-JD..	High Feed End Mills	Высокопроизводительные Концевые Фрезы	276
AFM75C-SP..	Face Milling	Торцевые Фрезы	352	AHFMC-JD..	Modular High Feed End Mills	Высокопроизводительные Торцевые Фрезы	299
AFM75-XO..	Face Milling	Торцевые Фрезы	322	AHFMC-WD..	Modular High Feed End Mills	Высокопроизводительные Торцевые Фрезы	302-303
AFM88C-SN..	Face Milling	Торцевые Фрезы	323-324-325-353	AHFM-ED..	Modular High Feed End Mills	Высокопроизводительные Торцевые Фрезы	296
AFM88-SN..	Face Milling	Торцевые Фрезы	321	AHFM-EN..	High Feed End Mills	Высокопроизводительные Концевые Фрезы	277
AFM89-SN..	Face Milling	Торцевые Фрезы	325	AHFM-EN..	High Feed Milling Tools	Высокопроизводительные Торцевые Фрезы	355
AFM90(L)-LN..	Face Milling	Торцевые Фрезы	332-333-334-335-336	AHFM-EN..	Modular High Feed End Mills	Высокопроизводительные Сменные Фрезерные Головки	297
AFM90(S)-SD..	Face Milling	Торцевые Фрезы	339	AHFM-EO..	High Feed End Mills	Высокопроизводительные Концевые Фрезы	275
				AHFM-EP..	High Feed End Mills	Высокопроизводительные Концевые Фрезы	275

KOD / CODE	AÇIKLAMA / DESCRIPTION	СОДЕРЖАНИЕ	S.N. / P.N. СТР.	KOD / CODE	AÇIKLAMA / DESCRIPTION	СОДЕРЖАНИЕ	S.N. / P.N. СТР.
AHFM-EP..	High Feed Milling Tools	Высокопроизводительные Торцевые Фрезы	355	AKL-123 ..	Blades	Ножи	182
AHFM-EP..	Modular High Feed End Mills	Высокопроизводительные Торцевые Фрезы	296	AKL-I ..	Blades	Ножи	181
AHFM-JD..	High Feed Milling Tools	Высокопроизводительные Торцевые Фрезы	278	AKL-SGC ..	Blades	Ножи	180
AHFM-JD..	Modular High Feed End Mills	Высокопроизводительные Торцевые Фрезы	299	AKL-TD ..	Blades	Ножи	181
AHFM-LN..	High Feed End Mills	Высокопроизводительные Концевые Фрезы	278	AKSR ..	Adjustable Rough Boring Heads Cartridge	Картриджи Регулируемой Расточной Головки для Чернового Точения	239
AHFM-LN..	Modular High Feed End Mills	Высокопроизводительные Торцевые Фрезы	298	ALBU ..	Blocks For Blades	Блоки к Сменным Ножам	182
AHFM-LN0303.. -H	Modular End Mills	Сменные Фрезерные Головки (Крепление под Резьбу)	276	ALKT-ZCC2-R/L ..	Face External Grooving Tool Holders	Державки для Обработки Торцевых Канавок	180
AHFM-LN0303.. -H	Modular (Screw Type) Highfeed End Mills	Сменные Фрезерные Головки (Крепление под Резьбу)	296	APMR-BNM..	Ball Nose End Mills	Сферические Концевые Фрезы	304
AHFM-LN0303.. -H	High Feed Milling Tools	Высокопроизводительные Торцевые Фрезы	356	APMR-BNM.. -H	Modular (Screw Type) End Mills	S-Тип Сменные Сферические Фрезерные Головки (Крепление Под Резьбу)	306
AHFM-LO..	High Feed End Mills	Высокопроизводительные Концевые Фрезы	279	APMR-P32..	Ball Nose End Mills	Сферические Концевые Фрезы	305
AHFM-LO..	High Feed Milling Tools	Высокопроизводительные Торцевые Фрезы	356	APMR-P32..	Ball Nose Modular End Mills	Сферические Фрезерные Головки (Крепление под Резьбу)	306
AHFM-LO..	Modular High Feed End Mills	Высокопроизводительные Торцевые Фрезы	298	APMR-RO..	Ball Nose End Mills	Сферические Концевые Фрезы	304
AHFM-LP..	High Feed End Mills	Высокопроизводительные Концевые Фрезы	280	APMR-SWB..	Ball Nose Modular End Mills	Сферические Фрезерные Головки (Крепление под Резьбу)	307
AHFM-SO..	High Feed End Mills	Высокопроизводительные Концевые Фрезы	281	APMR-XP..	Ball Nose End Mills	Сферические Концевые Фрезы	305
AHFM-SO..	High Feed Milling Tools	Высокопроизводительные Концевые Фрезы	359	APMR-XP..	Ball Nose Modular End Mills	Сферические Фрезерные Головки (Крепление под Резьбу)	307
AHFM-SO..	Modular High Feed End Mills	Высокопроизводительные Торцевые Фрезы	300-301	ASDM-CC..	Disc Milling	Дисковые Трехсторонние Фрезы	365
AHFM-SP..	High Feed End Mills	Высокопроизводительные Концевые Фрезы	281	ASDM-SPGT..	Disc Milling	Дисковые Трехсторонние Фрезы	364
AHFM-SP..	High Feed Milling Tools	Высокопроизводительные Концевые Фрезы	359	ASTB-..	Swiss Easy Change Tools	Swiss Easy Change Tools	87
AHFM-SP..	Modular High Feed End Mills	Высокопроизводительные Торцевые Фрезы	302	ATM..	Thread Milling Tools	Резьбонарезные Фрезы	308
AHFM-WN..	High Feed End Mills	Высокопроизводительные Концевые Фрезы	284	ATM60..	Thread Milling Tools	Резьбонарезные Фрезы	309
AHFM-WN..	Modular High Feed End Mills	Высокопроизводительные Торцевые Фрезы	303	ATSM90-CC..	T Slot Milling	T-Образные Фрезы	362
AHFM-WO..	High Feed End Mills	Высокопроизводительные Концевые Фрезы	285	ATSM90-SP..	T Slot Milling	T-Образные Фрезы	363
AHFM-YO..	High Feed End Mills	Высокопроизводительные Концевые Фрезы	283	ATSMR-RD..	T Slot Milling	T-Образные Фрезы	363
AHFM-YP..	High Feed End Mills	Высокопроизводительные Концевые Фрезы	282	ATTB ..	Anti Vibration Tool	Антивибрационная Державка	131
AHFM-YP..	Modular High Feed End Mills	Высокопроизводительные Концевые Фрезы	301	ATTC ..	Anti Vibration Tool	Антивибрационная Державка	134
AHM ..	Helix Chamfer Milling Tools	Спиральные Фрезы для Снятия Фаски	244	ATTC- .. SCLCR/L ..	Anti Vibration Tool	Антивибрационная Державка	132
AHM90-AP..	Helix End Mills	Спиральная Концевая Фреза (Кукрузная Фреза)	310	ATTC- .. SDUCR/L ..	Anti Vibration Tool	Антивибрационная Державка	132
AHM90-AP1204.. -H	Helix End Mills	Спиральная Концевая Фреза (Кукрузная Фреза)	310	ATTC- .. SVUCR/L ..	Anti Vibration Tool	Антивибрационная Державка	133
AIKT-123-R/L ..	Internal Grooving Tool Holders	Державки для Обработки Внутренних Канавок	190	ATTC- .. TCLNR/L ..	Anti Vibration Tool	Антивибрационная Державка	134
AIKT-154.91-R/L ..	Internal Grooving Tool Holders	Державки для Обработки Внутренних Канавок	190	ATTC- .. TDUNR/L ..	Anti Vibration Tool	Антивибрационная Державка	133
AIKT-GP-R/L ..	Internal Grooving Tool Holders	Державки для Обработки Внутренних Канавок	194	ATUM .. xD2 KDR ..	U-Drill	Сверла	221
AIKT-HK-R/L ..	Internal Grooving Tool Holders	Державки для Обработки Внутренних Канавок	189	ATUM .. xD2 SP ..	U-Drill	Сверла	209-210
AIKT-H-R/L ..	Internal Grooving Tool Holders	Державки для Обработки Внутренних Канавок	188	ATUM .. xD2 SPGT ..	U-Drill	Сверла	215
AIKT-HS223-R/L ..	Internal Grooving Tool Holders	Державки для Обработки Внутренних Канавок	189	ATUM .. xD2 WCM ..	U-Drill	Сверла	202-203
AIKT-IGE-R/L ..	Internal Grooving Tool Holders	Державки для Обработки Внутренних Канавок	192	ATUM .. xD3 KDR ..	U-Drill	Сверла	222
AIKT-IGI-R/L ..	Internal Grooving Tool Holders	Державки для Обработки Внутренних Канавок	192	ATUM .. xD3 SO ..	U-Drill	Сверла	219
AIKT-IG-R/L ..	Internal Grooving Tool Holders	Державки для Обработки Внутренних Канавок	193	ATUM .. xD3 SP ..	U-Drill	Сверла	211-212
AIKT-I-R/L ..	Internal Grooving Tool Holders	Державки для Обработки Внутренних Канавок	193	ATUM .. xD3 SPGT ..	U-Drill	Сверла	216-217
AIKT-ITG-R/L ..	Internal Grooving Tool Holders	Державки для Обработки Внутренних Канавок	194	ATUM .. xD3 WCM ..	U-Drill	Сверла	204-205
AIKT-KG-R/L ..	Internal Grooving Tool Holders	Державки для Обработки Внутренних Канавок	188	ATUM .. xD4 KDR ..	U-Drill	Сверла	221
AIKT-KM-R/L ..	Internal Grooving Tool Holders	Державки для Обработки Внутренних Канавок	189	ATUM .. xD4 SO ..	U-Drill	Сверла	220
AIKT-K-R/L ..	Internal Grooving Tool Holders	Державки для Обработки Внутренних Канавок	187	ATUM .. xD4 SP ..	U-Drill	Сверла	214
AIKT-MB..	Mini Grooving Tool	Мини Державка Для Обработки Внутренних Канавок	197	ATUM .. xD4 SPGT ..	U-Drill	Сверла	218
AIKT-QC.-R/L ..	Internal Grooving Tool Holders	Державки для Обработки Внутренних Канавок	195	ATUM .. xD4 WCM ..	U-Drill	Сверла	206-207
AIKT-RD-R/L ..	Internal Grooving Tool Holders	Державки для Обработки Внутренних Канавок	191	ATUM .. xD5 SP ..	U-Drill	Сверла	214
AIKT-SGC-R ..	Internal Grooving Tool Holders	Державки для Обработки Внутренних Канавок	196	ATUM .. xD5 WCM ..	U-Drill	Сверла	208
AIKT-TD-R/L ..	Internal Grooving Tool Holders	Державки для Обработки Внутренних Канавок	191	ATUM xD2 SOMT ..	U-Drill	Сверла	223
AIKT-TG-R/L ..	Internal Grooving Tool Holders	Державки для Обработки Внутренних Канавок	195	ATUM xD3 880 ..	U-Drill	Сверла	227
AIKT-ZCC2-R/L ..	Internal Grooving Tool Holders	Державки для Обработки Внутренних Канавок	196				
AKCR ..	Adjustable Rough Boring Heads Cartridge	Картриджи Регулируемой Расточной Головки для Чернового Точения	239				

KOD / CODE	AÇIKLAMA / DESCRIPTION	СОДЕРЖАНИЕ	S.N. / P.N. СТР.	KOD / CODE	AÇIKLAMA / DESCRIPTION	СОДЕРЖАНИЕ	S.N. / P.N. СТР.
ATUM xD3 SOMT ..	U-Drill	Сверла	224	PSDNN ..	External Tool Holders	Державки для Наружного Точения	55
ATUM xD4 SOMT ..	U-Drill	Сверла	225	PSKNR/L ..	Cartridge	Картриджи	144
ATUM xD5 SOMT ..	U-Drill	Сверла	226	PSKNR/L ..	External Tool Holders	Державки для Наружного Точения	55
ATW-..	Whirling Toolholders	Инструмент для вихревого резьбофрезерования	27	PSKNR/L ..	Internal Tool Holders	Расточные Державки	108
AVTT..	Screwed Tool Holders	Оправки для Сменных Головок	308	PSRNR/L ..	Cartridge	Картриджи	145
B11..	Valve Seat Inserts	Инструмент для Обработки Вкладышей Седла Клапана	24-25	PSSNR/L ..	External Tool Holders	Державки для Наружного Точения	56
B41.. - B42..	Broaching Inserts	Долбяки с СМП	18-19-20	PTFNR/L ..	Cartridge	Картриджи	145
CCLNR/L ..	External Tool Holders	Державки для Наружного Точения	65	PTFNR/L ..	External Tool Holders	Державки для Наружного Точения	56
CDJNR/L ..	External Tool Holders	Державки для Наружного Точения	65	PTGNR/L ..	External Tool Holders	Державки для Наружного Точения	57
CDNNN ..	External Tool Holders	Державки для Наружного Точения	66	PTJNR/L ..	External Tool Holders	Державки для Наружного Точения	57
CKJNR/L ..	External Tool Holders	Державки для Наружного Точения	64	PTTNR/L ..	External Tool Holders	Державки для Наружного Точения	58
CKUNR/L ..	Internal Tool Holders	Расточные Державки	98	PTUNR/L ..	Internal Tool Holders	Расточные Державки	109
CRDCN ..	External Tool Holders	Державки для Наружного Точения	66	PWLNRL/L ..	External Tool Holders	Державки для Наружного Точения	58
CRDCR/L ..	External Tool Holders	Державки для Наружного Точения	67	PWLNRL/L ..	Internal Tool Holders	Расточные Державки	110
CSDNN ..	External Tool Holders	Державки для Наружного Точения	67	PWLNRL/L ..-H	External Turning Toolholders With Coolant Tools	Державка для обработки наружных канавок с подводом СОЖ	61
CSKNR/L ..	External Tool Holders	Державки для Наружного Точения	68	S/SCLCR/L ..	Boring Bars SET	Наборы Расточных Державок	127
CSRNR/L ..	External Tool Holders	Державки для Наружного Точения	68	S/SDUCR/L ..	Boring Bars SET	Наборы Расточных Державок	128
CSSNR/L ..	External Tool Holders	Державки для Наружного Точения	69	SCACR/L ..	Engine Overhaul Cartridge	Хонингованные Картриджи	139
CTJNR/L ..	External Tool Holders	Державки для Наружного Точения	69	SCACR/L ..	External Tool Holders	Державки для Наружного Точения	71
E/SCLCR/L ..	Boring Bars SET	Наборы Расточных Державок	127	SCACR/L ..-S	External Tool Holders Swiss Type	Державки для Наружного Точения Swiss Type	83
E/SDUCR/L ..	Boring Bars SET	Наборы Расточных Державок	128	SCFCR/L	Spare Parts Of Cartridge	Запасные части für Kasette	146
E/STFCR/L ..	Boring Bars	Расточных Державок	126	SCFCR/L ..	Cartridge	Картриджи	141
E/STUPR/L ..	Boring Bars	Расточных Державок	126	SCFCR/L ..	Internal Tool Holders	Расточные Державки	113
MCLNR/L ..	Internal Tool Holders	Расточные Державки	100	SCLCR/L ..	Boring Bars With Carbide Shank	Расточная державка из Твердосплавного Карбида	125
MDUNR/L ..	Internal Tool Holders	Расточные Державки	100	SCLCR/L ..	External Tool Holders	Державки для Наружного Точения	71
MTENN ..	External Tool Holders	Державки для Наружного Точения	49	SCLCR/L ..	Internal Tool Holders	Расточные Державки	112
MTFNR/L ..	Internal Tool Holders	Расточные Державки	101	SCLCR/L ..-S	External Tool Holders Swiss Type	Державки для Наружного Точения Swiss Type	84
MTJNR/L ..	External Tool Holders	Державки для Наружного Точения	49	SCMCN ..	Engine Overhaul Cartridge	Хонингованные Картриджи	140
MT-NR/L ..	Internal Tool Holders	Расточные Державки	101	SCMCN ..	External Tool Holders	Державки для Наружного Точения	72
MTQNR/L ..	Internal Tool Holders	Расточные Державки	102	SCSCR/L	Spare Parts Of Cartridge	Запасные части für Kasette	146
MTUNR/L ..	Internal Tool Holders	Расточные Державки	102	SCSCR/L ..	Cartridge	Картриджи	142
MWLNRL/L ..	External Tool Holders	Державки для Наружного Точения	50	SDACR/L ..-S	External Tool Holders Swiss Type	Державки для Наружного Точения Swiss Type	84
MWLNRL/L ..	Internal Tool Holders	Расточные Державки	103	SD-CR/L ..	Internal Tool Holders	Расточные Державки	113
MWMNN ..	External Tool Holders	Державки для Наружного Точения	50	SDHCR/L ..	External Tool Holders	Державки для Наружного Точения	72
PCBNR/L ..	External Tool Holders	Державки для Наружного Точения	52	SDJCR/L ..	External Tool Holders	Державки для Наружного Точения	73
PCLNR/L ..	External Tool Holders	Державки для Наружного Точения	52	SDJCR/L ..	Sec Tools	Sec Tools	88
PCLNR/L ..	Internal Tool Holders	Расточные Державки	105	SDJCR/L ..-S	External Tool Holders Swiss Type	Державки для Наружного Точения Swiss Type	85
PCLNR/L.. -H	External Turning Toolholders With Coolant Tools	Державки для Наружного Точения с подводом СОЖ	60	SDJCR/L..	Swiss Easy Change Tools	Swiss Easy Change Tools	88
PCMNN ..	External Tool Holders	Державки для Наружного Точения	53	SDNCN ..	External Tool Holders	Державки для Наружного Точения	73
PDJNR/L ..	External Tool Holders	Державки для Наружного Точения	53	SDPCR/L ..	Internal Tool Holders	Расточные Державки	114
PDJNR/L .. -H	External Turning Toolholders With Coolant Tools	Державки для Наружного Точения с подводом СОЖ	60	SDQCR/L ..	Internal Tool Holders	Расточные Державки	114
PDNNN ..	External Tool Holders	Державки для Наружного Точения	54	SDUCR/L ..	Boring Bars With Carbide Shank	Bohrstangen mit Hartmetallschaft	125
PDNNN-H	External Turning Toolholders With Coolant Tools	Державки для Наружного Точения с подводом СОЖ	61	SDUCR/L ..	Internal Tool Holders	Расточные Державки	115
PDQNR/L ..	Internal Tool Holders	Расточные Державки	106	SDXCR/L ..	Internal Tool Holders	Расточные Державки	116
PDUNR/L ..	Internal Tool Holders	Расточные Державки	107	SER/L ..	External Threading Tool Holders	Державка для Нарезания Наружной Резьбы	150
PDXNR/L ..	Internal Tool Holders	Расточные Державки	106	SER/L ..	Sec Tools	Sec Tools	89
PSBNR/L ..	External Tool Holders	Державки для Наружного Точения	54	SIR/L ..	Internal Threading Tool Holders	Державка для Нарезания Внутренней Резьбы	151
PSDNN ..	Cartridge	Картриджи	146				

KOD / CODE	AÇIKLAMA / DESCRIPTION	СОДЕРЖАНИЕ	S.N. / P.N. СТР.	KOD / CODE	AÇIKLAMA / DESCRIPTION	СОДЕРЖАНИЕ	S.N. / P.N. СТР.
SRDCN ..	External Tool Holders	Державки для Наружного Точения	74	SVXBR/L ..	Internal Tool Holders	Расточные Державки	123
SRDCR/L ..	External Tool Holders	Державки для Наружного Точения	75	SWLCR ..	Internal Tool Holders	Расточные Державки	124
SRGCR/L ..	External Tool Holders	Державки для Наружного Точения	75	SWUBR ..	Internal Tool Holders	Расточные Державки	124
SRGCR/L ..	Internal Tool Holders	Расточные Державки	117	T09..	Whirling Inserts	Gewindewirbelplatte	28-29
SRHCR/L ..	External Tool Holders	Державки для Наружного Точения	76	T12.10	Poly-V Grooving Inserts	Poly-V Riemennuten	12
SRSCN..	Engine Overhaul Cartridge	Motorüberholungskassette	140	T20	Corner Reliefs Grooving Inserts	Eckreliefs Einstechplatten	16
SRXCR/L ..	External Tool Holders	Державки для Наружного Точения	76	TCBNR/L ..	External Tool Holders	Державки для Наружного Точения	35
SSDCN ..	External Tool Holders	Державки для Наружного Точения	77	TCKNR/L ..	External Tool Holders	Державки для Наружного Точения	35
SSKCR/L ..	Cartridge	Картриджи	142	TCLNR/L ..	External Tool Holders	Державки для Наружного Точения	36
SSSCR/L ..	External Tool Holders	Державки для Наружного Точения	77	TCLNR/L ..	Internal Tool Holders	Расточные Державки	94
SSSCR/L ..	Internal Tool Holders	Расточные Державки	117	TCLNR/L .. -H	External Turning Toolholders With Coolant Tools	Державки для Наружного Точения с подводом СОЖ	45
STCCN ..	External Tool Holders	Державки для Наружного Точения	79	TCMNN ..	External Tool Holders	Державки для Наружного Точения	36
ST-CR/L ..	Internal Tool Holders	Расточные Державки	118	TCZNN ..	External Tool Holders	Державки для Наружного Точения	37
STFCR/L	Spare Parts Of Cartridge	Запасные части für Kassette	146	TDHNR/L ..	External Tool Holders	Державки для Наружного Точения	37
STFCR/L ..	Cartridge	Картриджи	143	TDJNR/L ..	External Tool Holders	Державки для Наружного Точения	38
STFCR/L ..	External Tool Holders	Державки для Наружного Точения	78	TDJNR/L .. -H	External Turning Toolholders With Coolant Tools	Державки для Наружного Точения с подводом СОЖ	45
STFCR/L ..	Internal Tool Holders	Расточные Державки	118	TDNNN ..	External Tool Holders	Державки для Наружного Точения	38
STGCR/L ..	External Tool Holders	Державки для Наружного Точения	78	TDNNN-H	External Turning Toolholders With Coolant Tools	Державки для Наружного Точения с подводом СОЖ	46
STGCR/L ..-S	External Tool Holders Swiss Type	Державки для Наружного Точения Swiss Type	85	TD-NR/L ..	Internal Tool Holders	Расточные Державки	94
STJCR/L ..	External Tool Holders	Державки для Наружного Точения	79	TDQNR/L ..	Internal Tool Holders	Расточные Державки	95
STSCR/L	Spare Parts Of Cartridge	Запасные части für Kassette	146	TDUNR/L ..	Internal Tool Holders	Расточные Державки	95
STSCR/L ..	Cartridge	Картриджи	143	TER/L ..	External Threading Tool Holders	Державка для Нарезания Наружной Резьбы	152
STTCR/L	Spare Parts Of Cartridge	Запасные части für Kassette	146	TER/L ..	Sec Tools	Sec Tools	89
STTCR/L ..	Cartridge	Картриджи	144	TIR/L ..	Internal Threading Tool Holders	Державка для Нарезания Внутренней Резьбы	153
STUCR/L ..	External Tool Holders	Державки для Наружного Точения	80	TSDNN ..	External Tool Holders	Державки для Наружного Точения	39
STUCR/L ..	Internal Tool Holders	Расточные Державки	119	TSKNR/L ..	External Tool Holders	Державки для Наружного Точения	39
STUPR/L ..	Internal Tool Holders	Расточные Державки	120	TSKNR/L ..	Internal Tool Holders	Расточные Державки	96
STXCR/L ..	Engine Overhaul Cartridge	Motorüberholungskassette	141	TSSNR/L ..	External Tool Holders	Державки для Наружного Точения	40
SVACR/L ..-S	External Tool Holders Swiss Type	Державки для Наружного Точения Swiss Type	86	TTENN ..	External Tool Holders	Державки для Наружного Точения	40
SVHBR/L ..	External Tool Holders	Державки для Наружного Точения	80	TTGNR/L ..	External Tool Holders	Державки для Наружного Точения	41
SVHCR/L ..	External Tool Holders	Державки для Наружного Точения	81	TTJNR/L ..	External Tool Holders	Державки для Наружного Точения	41
SVJBR/L ..	External Tool Holders	Державки для Наружного Точения	81	TT-NR/L ..	Internal Tool Holders	Расточные Державки	96
SVJBR/L ..	Internal Tool Holders	Расточные Державки	120	TTUNR/L ..	Internal Tool Holders	Расточные Державки	97
SVJBR/L ..-S	External Tool Holders Swiss Type	Державки для Наружного Точения Swiss Type	86	TVHNR/L ..	External Tool Holders	Державки для Наружного Точения	42
SVJCR/L	Swiss Easy Change Tools	Swiss Easy Change Tools	88	TVJNR/L ..	External Tool Holders	Державки для Наружного Точения	42
SVJCR/L ..	External Tool Holders	Державки для Наружного Точения	82	TVUNR/L ..	Internal Tool Holders	Расточные Державки	97
SVJCR/L ..	Internal Tool Holders	Расточные Державки	123	TVVNN ..	External Tool Holders	Державки для Наружного Точения	43
SVJCR/L ..	Sec Tools	Sec Tools	88	TWLNR/L ..	External Tool Holders	Державки для Наружного Точения	43
SVJCR/L ..-S	External Tool Holders Swiss Type	Державки для Наружного Точения Swiss Type	87	TWLNR/L ..	Internal Tool Holders	Расточные Державки	98
SVQBR/L ..	Internal Tool Holders	Расточные Державки	121	TWLNR/L .. -H	External Turning Toolholders With Coolant Tools	Державки для Наружного Точения с подводом СОЖ	46
SVQCR/L ..	Internal Tool Holders	Расточные Державки	121	VST-B11..	Valve Seat Toolholders	Инструмент для Обработки Вкладышей Седла Клапана	23-24
SVUBR/L ..	Internal Tool Holders	Расточные Державки	122				
SVUCR/L ..	Internal Tool Holders	Расточные Державки	122				
SVVBN ..	External Tool Holders	Державки для Наружного Точения	82				
SVVCN ..	External Tool Holders	Державки для Наружного Точения	83				

KOD / CODE	AÇIKLAMA / DESCRIPTION	СОДЕРЖАНИЕ	S.N. / P.N. СТР.
AACN-..	Spare Parts	Запасные части	372
AADN-..	Spare Parts	Запасные части	372
AAL-..	Spare Parts	Запасные части	385
AARC-..	Spare Parts	Запасные части	372
AASD-..	Spare Parts	Запасные части	372
AASE-..	Spare Parts	Запасные части	372
AASN-..	Spare Parts	Запасные части	372
AATN-..	Spare Parts	Запасные части	372
AAV-..	Spare Parts	Запасные части	375-383
AAVN-..	Spare Parts	Запасные части	372
AAWN-..	Spare Parts	Запасные части	372
AAW-..	Spare Parts	Запасные части	378
ABK-..	Spare Parts	Запасные части	385
ABKS-..	Spare Parts	Запасные части	384
ABPL-..	Spare Parts	Запасные части	384
ACK-..	Spare Parts	Запасные части	373
ACS-..	Spare Parts	Запасные части	383
AEV-..	Spare Parts	Запасные части	379
AKS-..	Spare Parts	Запасные части	372
AKV-..	Spare Parts	Запасные части	374-375-376-377
AKY-..	Spare Parts	Запасные части	376
ALA-..	Spare Parts	Запасные части	385
ALV-..	Spare Parts	Запасные части	377
AMK-..	Spare Parts	Запасные части	373
AN-01..	Spare Parts	Запасные части	374
AOR-01	Spare Parts	Запасные части	384
APL-..	Spare Parts	Запасные части	377
APM-..	Spare Parts	Запасные части	378
AS-01	Spare Parts	Запасные части	383
ATK-..	Spare Parts	Запасные части	373
ATKH-..	Spare Parts	Запасные части	373
ATS-..	Spare Parts	Запасные части	372
AXR-01	Spare Parts	Запасные части	384
1008-..	Spare Parts	Запасные части	380
1015-..	Spare Parts	Запасные части	380-381
1020-..	Spare Parts	Запасные части	379
1108-..	Spare Parts	Запасные части	380
1120-..	Spare Parts	Запасные части	381
1204-..	Spare Parts	Запасные части	379
1208-..	Spare Parts	Запасные части	379
1210-..	Spare Parts	Запасные части	379
1215-..	Spare Parts	Запасные части	379
1220-..	Spare Parts	Запасные части	379
1315-..	Spare Parts	Запасные части	380-381
1415-..	Spare Parts	Запасные части	379
1420-..	Spare Parts	Запасные части	381
1510-..	Spare Parts	Запасные части	380
1515-..	Spare Parts	Запасные части	381
1520-..	Spare Parts	Запасные части	381

KOD / CODE	AÇIKLAMA / DESCRIPTION	СОДЕРЖАНИЕ	S.N. / P.N. СТР.
1615-..	Spare Parts	Запасные части	380-381
1620-..	Spare Parts	Запасные части	381
1707-..	Spare Parts	Запасные части	381
1710-..	Spare Parts	Запасные части	381
1720-..	Spare Parts	Запасные части	379
1904-..	Spare Parts	Запасные части	377
2004-..	Spare Parts	Запасные части	377
2306-..	Spare Parts	Запасные части	383
2405-..	Spare Parts	Запасные части	383
2406-..	Spare Parts	Запасные части	383
2407-..	Spare Parts	Запасные части	383
2408-..	Spare Parts	Запасные части	383
2503-..	Spare Parts	Запасные части	383
2504-..	Spare Parts	Запасные части	383
2505-..	Spare Parts	Запасные части	383
2506-..	Spare Parts	Запасные части	383
2508-..	Spare Parts	Запасные части	381
2510-..	Spare Parts	Запасные части	383
2514-..	Spare Parts	Запасные части	383
2525-..	Spare Parts	Запасные части	383
2600-..	Spare Parts	Запасные части	382
2702-..	Spare Parts	Запасные части	382
2703-..	Spare Parts	Запасные части	382
2704-..	Spare Parts	Запасные части	382
2705-..	Spare Parts	Запасные части	382
2715-..	Spare Parts	Запасные части	382
2725-..	Spare Parts	Запасные части	382
3006-..	Spare Parts	Запасные части	380
3007-..	Spare Parts	Запасные части	380
3008-..	Spare Parts	Запасные части	380
3010-..	Spare Parts	Запасные части	380
3015-..	Spare Parts	Запасные части	380-381
3108-..	Spare Parts	Запасные части	380
4006-..	Spare Parts	Запасные части	380
4008-..	Spare Parts	Запасные части	380
4010-..	Spare Parts	Запасные части	380
4015-..	Spare Parts	Запасные части	380-381
4020-..	Spare Parts	Запасные части	381
4108-..	Spare Parts	Запасные части	380
4115-..	Spare Parts	Запасные части	381
4420-..	Spare Parts	Запасные части	381
4515-..	Spare Parts	Запасные части	381
4615-..	Spare Parts	Запасные части	381
80-..	Spare Parts	Запасные части	385
81-..	Spare Parts	Запасные части	385



konusulan
the spoken kalite...
quality...



www.ako.com.tr



konusulan
the spoken kalite...
quality...







Konya Organize Sanayi Bölgesi
Işıktepe Sk. No:6 P.K. 42250
Selçuklu / KONYA / TÜRKİYE

Tel : +90 332 239 17 57 (pbx)
Fax : +90 332 239 17 52
GPS: 37.973262 N / 32.604158 E

www.akkо.com.tr
akkо@akkо.com.tr
export@akkо.com.tr



    /akkо.com.tr

Yenilikler için bizi takip edin!
Follow us for news!
Für Neuheiten bitte uns folgen