

HIGH PRECISION MACHINING TOOLS

GENERAL CATALOGUE **E**

SOLID
CARBIDE
TOOLS



COMPANY PROFILE

HPMT Industries Sdn Bhd, the leading producer of cutting tools in South-East Asia, with over 40 years of experience in tool design and manufacturing.

With the latest production machinery and in house R&D facilities, HPMT is progressively developing new tools to serve the ever demanding industrial market.

We are committed to design high-quality products manufactured with state-of the art technology to deliver high performance in every application. We work together with customers from various industries as their machining tools partner to identify the right tools for their applications or design customized tools to suit every customer's manufacturing environment: mould & die, automotive, electronics, oil & gas, aerospace, medical and more.



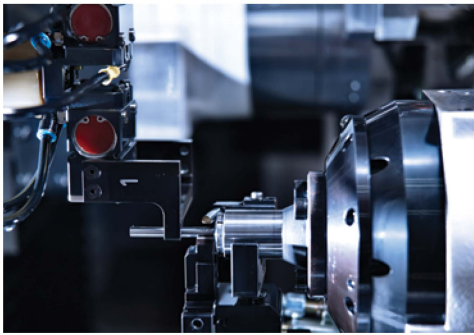

STEP

1

SEARCH BY

Option 1 MATERIAL DIRECTORY

Search by material to be cut

		ENDMILLS														BALLNOSE						DRILL														
Please select the material.		ALL LINE	EZ LINE	SE 30	NTICo-30	OPTIMUM	SE 45	SE 45X	NTICo-45	SE 60	SE 60X	TRIP	SE 70	SE 80	TE 45	PLUNG	THREAD	DR 30	DR 45	BN 60	BN 60X	DMPC	BN GR	NC Spot	DR ALU	EZ LINE	DR	DR VA	DR-S	DR Mini	DR-LX	DR 85 SS	DR 60	SE 45		
		Non Ferrous Metals	1.50 HRC	1.50 HRC	1.45 HRC	1.45 HRC	1.50 HRC	1.50 HRC	1.50 HRC	1.50 HRC	1.50 HRC	1.50 HRC	1.50 HRC	1.50 HRC	1.45 HRC	1.45 HRC	1.50 HRC	1.50 HRC	1.50 HRC	1.50 HRC	1.50 HRC	1.50 HRC	1.50 HRC	1.50 HRC	1.50 HRC	1.50 HRC	1.50 HRC	1.50 HRC	1.50 HRC	1.50 HRC	1.50 HRC	1.50 HRC	1.50 HRC	1.50 HRC		
ALU1	Aluminum wrought alloy, Si < 9%	✓	✓	✓	✓	✓	✓	✓	✓	✓	✓	✓	✓	✓	✓	✓	✓	✓	✓	✓	✓	✓	✓	✓	✓	✓	✓	✓	✓	✓	✓	✓	✓	✓	✓	
ALU2	Aluminum cast alloy, Si > 9%	✓	✓	✓	✓	✓	✓	✓	✓	✓	✓	✓	✓	✓	✓	✓	✓	✓	✓	✓	✓	✓	✓	✓	✓	✓	✓	✓	✓	✓	✓	✓	✓	✓	✓	
COP1	Copper alloy	✓	✓	✓	✓	✓	✓	✓	✓	✓	✓	✓	✓	✓	✓	✓	✓	✓	✓	✓	✓	✓	✓	✓	✓	✓	✓	✓	✓	✓	✓	✓	✓	✓	✓	
CAST1	Grey cast iron	✓	✓	✓	✓	✓	✓	✓	✓	✓	✓	✓	✓	✓	✓	✓	✓	✓	✓	✓	✓	✓	✓	✓	✓	✓	✓	✓	✓	✓	✓	✓	✓	✓	✓	✓
CAST2	Ductile cast iron	✓	✓	✓	✓	✓	✓	✓	✓	✓	✓	✓	✓	✓	✓	✓	✓	✓	✓	✓	✓	✓	✓	✓	✓	✓	✓	✓	✓	✓	✓	✓	✓	✓	✓	✓
STEEL1	Carbon steel	✓	✓	✓	✓	✓	✓	✓	✓	✓	✓	✓	✓	✓	✓	✓	✓	✓	✓	✓	✓	✓	✓	✓	✓	✓	✓	✓	✓	✓	✓	✓	✓	✓	✓	✓
STEEL2	Alloy steel	✓	✓	✓	✓	✓	✓	✓	✓	✓	✓	✓	✓	✓	✓	✓	✓	✓	✓	✓	✓	✓	✓	✓	✓	✓	✓	✓	✓	✓	✓	✓	✓	✓	✓	✓
STEEL3	Prehardened steel, 35 ± HRC - 45	✓	✓	✓	✓	✓	✓	✓	✓	✓	✓	✓	✓	✓	✓	✓	✓	✓	✓	✓	✓	✓	✓	✓	✓	✓	✓	✓	✓	✓	✓	✓	✓	✓	✓	✓

Option 2 INDEX BY SERIES

Search by Series Name / Diameter / Geometry

Index by Series										Index by Series																								
EDP Number	Type	Type	Type	Type	Type	Type	Type	Type	Type	Application	P	M	P	M	S	H	D	Temp	Other	Working Material	P	M	P	M	S	H	D	Temp	Other	Working Material				
788	AL SE	1	25°	UC	Carbon steel	Alloy steel	Prehardened steel, 35 ± HRC - 45	Stainless steel, high machinability	Stainless steel, low machinability	Grey cast iron	Ductile cast iron	Aluminum wrought alloy, Si < 9%	Aluminum cast alloy, Si > 9%	Copper alloy	Titanium alloy	Nickel alloy	Coal alloy	Inconel alloy, 45 ± HRC - 50	Inconel alloy, 1.50 HRC	Thermoplastics	Drillable	High alloy / B	44	44	44	44	44	44	44	44	44			
924	AL SE, Flute Polished	1	25°	UC	Carbon steel	Alloy steel	Prehardened steel, 35 ± HRC - 45	Stainless steel, high machinability	Stainless steel, low machinability	Grey cast iron	Ductile cast iron	Aluminum wrought alloy, Si < 9%	Aluminum cast alloy, Si > 9%	Copper alloy	Titanium alloy	Nickel alloy	Coal alloy	Inconel alloy, 45 ± HRC - 50	Inconel alloy, 1.50 HRC	Thermoplastics	Drillable	High alloy / B	44	44	44	44	44	44	44	44	44	44	44	
040	AL SE	2	40°	UC	Carbon steel	Alloy steel	Prehardened steel, 35 ± HRC - 45	Stainless steel, high machinability	Stainless steel, low machinability	Grey cast iron	Ductile cast iron	Aluminum wrought alloy, Si < 9%	Aluminum cast alloy, Si > 9%	Copper alloy	Titanium alloy	Nickel alloy	Coal alloy	Inconel alloy, 45 ± HRC - 50	Inconel alloy, 1.50 HRC	Thermoplastics	Drillable	High alloy / B	44	44	44	44	44	44	44	44	44	44	44	44
301	AL SE	2	50°	UC	Carbon steel	Alloy steel	Prehardened steel, 35 ± HRC - 45	Stainless steel, high machinability	Stainless steel, low machinability	Grey cast iron	Ductile cast iron	Aluminum wrought alloy, Si < 9%	Aluminum cast alloy, Si > 9%	Copper alloy	Titanium alloy	Nickel alloy	Coal alloy	Inconel alloy, 45 ± HRC - 50	Inconel alloy, 1.50 HRC	Thermoplastics	Drillable	High alloy / B	44	44	44	44	44	44	44	44	44	44	44	44

Option 3 INDEX BY EDP

Search by EDP

Index by EDP			Index by EDP		
EDP No	Description	Page	EDP No	Description	Page
186	SE 45 Long	203	851	SE 45	181
202	SE 45 Extra-Long	204	855	SE 45 Long	182
301	AL SE	46	859	SE 45 Extra-Long	183
303	AL SE	51	862	SE 45	184

STEP
2

SMALL INDEX

Index - Alu Line, For Non Ferrous Metal



Suitable for Material Groups
 Adapté pour les matériaux
 适用于材料
 Geeignet für die Materialgruppen
 Adatto per il materiale

N **O**

EDP Number	Type	No. Z	Helix Angle	Coating	Performance	Page Number
788	AL SE	1	25°	UC	G	44
924	AL SE, Flute Polished	1	25°	UC	G	44

STEP
3

PRODUCT SELECTION PAGE





EZ LINE - ENDMILL SE 30 NITICO 30 OPTIMUM

Order Number	Dimension (mm)					Normal	UC	Order Number	Dimension (mm)					Flute Polished
	D	I1	I2	L	d2 (h6)				D	I1	I2	L	d2 (h6)	
788 0200	2	10		40	2	•	924 0200	2	10		40	2	•	
788 0300	3	12		40	3	•	924 0300	3	12		40	3	•	
788 0400	4	15		50	4	•	924 0400	4	15		50	4	•	

STEP
4

CUTTING PARAMETER



ALU LINE - ENDMILL SE 30 NITICO 30 OPTIMUM

AL SE Single Flute Endmills, 1 Flute - 788, 924



Slotting	N				O			
	Wrought Aluminium		Cast Aluminium		Copper alloy		Thermoplastic	
Properties	Si < 9%		Si ≥ 9%		-		-	
Cutting depth, ap	1.00 x D		1.00 x D		1.00 x D		1.00 x D	
Cutting Width, ae	1.00 x D		1.00 x D		1.00 x D		1.00 x D	
D	Vc		Fz		Vc		Fz	
2	290		0.022		250		0.018	
3			0.038				0.013	
4			0.063				0.023	
5			0.081				0.039	
6			0.101				0.051	
8			0.139				0.064	
10			0.179				0.088	
12			0.221				0.114	
					160		0.142	
							270	
							0.020	
							0.035	
							0.058	
							0.076	
							0.095	
							0.129	
							0.166	
							0.210	

A4Q / A4R



BN 60X BALLNOSE CUTTERS / WITH RECESS, 2 FLUTES ①

- VHM BN 60X Standard Radiusschafffräser, 2 Zähne
- Frese sferiche BN 60X, 2 taglienti
- Fraises BN 60X Standard, à bout hémisphérique, 2 dents
- 整体硬质合金 BN 60X 系列 2刃球头铣刀

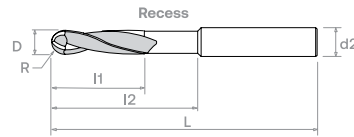
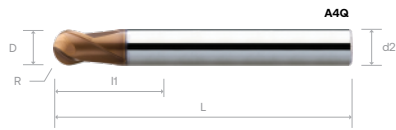

BN 30
BN 45
BN 60
BN 60X
DM70 - BN 70
BN GR

Order Number	Dimension (mm)							B0909	Order Number	Dimension (mm)							B0909
	D	R	I1	I2	L	d2 (h6)				D	R	I1	I2	L	d2 (h6)		
A4Q 0050 ②	0.5	0.25	0.5		50	4	°		A4R 0050 ③	0.5	0.25	0.5		50	4		
A4Q 0060	0.6	0.3	0.6		50	4	•		A4R 0060	0.6	0.3	0.6		50	4		
A4Q 0080	0.8	0.4	0.8		50	4	•		A4R 0080	0.8	0.4	0.8		50	4		
A4Q 0100	1	0.5	1		50	4	•		A4R 0100	1	0.5	1	4	50	4	°	
A4Q 0150	1.5	0.75	1.5		50	4	•		A4R 0150	1.5	0.75	1.5	6	50	4	°	
A4Q 0200	2	1	2		50	4	•		A4R 0200	2	1	2	8	50	4	•	
A4Q 0250	2.5	1.25	2.5		50	4	•		A4R 0250	2.5	1.25	2.5	10	50	4	°	
A4Q 0300 050 04					50	4	°		A4R 0300 050 04				14	50	4	°	
A4Q 0300 050 06	3	1.5	3		50	6	•		A4R 0300 050 06	3	1.5	3	14	50	6	•	
A4Q 0400 050 06	4	2	4		50	6	•		A4R 0400 050 06	4	2	4	20	50	6	•	
A4Q 0500 050 06	5	2.5	5		50	6	•		A4R 0500 050 06	5	2.5	5	20	50	6	°	
A4Q 0600 050					50	6	•		A4R 0600 050				20	50	6	°	
A4Q 0600 060	6	3	6		60	6	•		A4R 0600 060	6	3	6	30	60	6	•	
A4Q 0800	8	4	8		64	8	•		A4R 0800	8	4	8	30	64	8	•	
A4Q 1000	10	5	10		70	10	•		A4R 1000	10	5	10	32	70	10	°	
A4Q 1200	12	6	12		75	12	•		A4R 1200	12	6	12	38	75	12	°	
A4Q 1600	16	8	16		90	16	•		A4R 1600	16	8	16	46	90	16	°	
A4Q 1800	18	9	18		100	18	°		A4R 1800	18	9	18	53	100	18	°	
A4Q 2000	20	10	20		100	20	°		A4R 2000	20	10	20	58	100	20	°	

Diameter (mm)	Radius Tolerance
R ≤ 2.5	+0.005
2.5 ≤ R ≤ 6	+0.010
6 < R	+0.015

Material Group | Material-Gruppe | Groupe Matière | Gruppo Materiali | 材质主类

Cutting Parameter

N01
N02
N03
K01
K02
P01
P02
P03
M01
M02
S01
S02
S03
H01
H02
O01
O02
415

Please define the style **1** you want to use.

Then please state catalogue number for the selected coating for tools without recess **2** or for tools with recess **3** and the diameter / EDP No. (please always state the data mentioned in diameter line) you want to order.

Example based on page 413:

BN 60X Ballnose Cutters, 2 Flutes, Ø 20mm

Without Recess - A4Q 2000

With Recess - A4R 2000



WIE BESTELLEN

Bitte wählen Sie die Ausführung **1** die Sie benutzen möchten.

Danach geben Sie bitte die Katalog-Nummer für die ausgewählte Beschichtung für Werkzeuge ohne Freistellung **2** oder für Werkzeuge mit Freistellung **3** und die Abmessung / EDV-Nr.

Beispiel gemäß Seite 413:

VHM BN 60X Standard Radiusschaftfräser, 2 Zähne, Ø 20mm

Mit Freistellung - A4Q 2000

Ohne Freistellung - A4R 2000



COMMENT COMMANDER

Prière de sélectionner l'exécution **1** que vous aimeriez employer.

Après veuillez s.v.p. indiquer le numéro de référence pour le revêtement choisi pour l'outil sans dégagement **2** ou outil avec dégagement **3** ainsi que le diamètre / CODE usine.

Exemple suivant page 413:

Frese sferiche BN 60X, 2 taglienti, Ø 20mm

Con riduzione gambo - A4Q 2000

Senza riduzione gambo - A4R 2000



COME ORDINARE

Selezionate p.f. la tipologia **1** che desiderate impiegare.

Dopo indicate il numero di catalogo per il rivestimento scelto per l'utensile senza riduzione del gambo **2** o con riduzione del gambo **3** come pure il diametro / Codice EDP.

Esempio basato sulla pagina 413:

Fraises BN 60X Standard, à bout hémisphérique, 2 dents, Ø 20mm

a vec dégagement - A4Q 2000

sans dégagement - A4R 2000



定货指南

首先确定您需要的型号 **1**

然后根据样本选择您需要订购刀具的涂层,带RC **2** 或不带RC **3** 以及直径/编号。

例如第413页:

整体硬质合金 BN 60X 系列 2刀球头铣刀, Ø 20mm

有带颈位 - A4Q 2000

有没带颈位 - A4R 2000

Table of Content



Solid Carbide Tools



VHM Zerspanungs-werkzeuge



Outils de coupe en carbure monobloc



Utensili in metallo duro integrale













钨钢刀具

Page

Index	Index	Index	Indice	索引	17
Square Endmills	Schaftfräser	Fraises	Frese cilindriche	铣刀	
Alu Line	Alu Line	Alu Line	Alu Line	Alu Line	43
EZ Line - Endmill for materials ≤ 35 HRC	EZ Line - Schaftfräser für Materialien ≤ 35 HRC	EZ Line - Fraises pour matières ≤ 35 HRC	EZ Line - Frese cilindriche per materiali ≤ 35 HRC	EZ Line - 铣刀 可用于 ≤ 35 HRC 以下之材料	84
SE 30 for materials ≤ 35 HRC	SE 30 für Materialien ≤ 35 HRC	SE 30 pour matières ≤ 35 HRC	SE 30 per materiali ≤ 35 HRC	SE 30 可用于 ≤ 35 HRC 以下之材料	90
NiTiCo 30 for materials ≤ 45 HRC	NiTiCo 30 für Materialien ≤ 45 HRC	NiTiCo 30 pour matières ≤ 45 HRC	NiTiCo 30 per materiali ≤ 45 HRC	NiTiCo 30 可用于 ≤ 45 HRC 以下之材料	109
Optimum for materials ≤ 45 HRC	Optimum für Materialien ≤ 45 HRC	Optimum pour matières ≤ 45 HRC	Optimum per materiali ≤ 45 HRC	Optimum 可用于 ≤ 45 HRC 以下之材料	161
SE 45 for materials 36 - 50 HRC	SE 45 für Materialien 36 - 50 HRC	SE 45 pour matières 36 - 50 HRC	SE 45 per materiali 36 - 50 HRC	SE 45 可用于 36 - 50 HRC 以下之材料	175
SE 45X for materials ≤ 52 HRC	SE 45X für Materialien ≤ 52 HRC	SE 45X pour matières ≤ 52 HRC	SE 45X per materiali ≤ 52 HRC	SE 45X 可用于 ≤ 52 HRC 以下之材料	231
NiTiCo 45 for materials 36 - 52 HRC	NiTiCo 45 für Materialien 36 - 52 HRC	NiTiCo 45 pour matières 36 - 52 HRC	NiTiCo 45 per materiali 36 - 52 HRC	NiTiCo 45 可用于 36 - 52 HRC 以下之材料	238
SE 60 for materials 53 - 68 HRC	SE 60 für Materialien 53 - 68 HRC	SE 60 pour matières 53 - 68 HRC	SE 60 per materiali 53 - 68 HRC	SE 60 可用于 53 - 68 HRC 以下之材料	249
SE 60X for materials 40 - 60 HRC	SE 60X für Materialien 40 - 60 HRC	SE 60X pour matières 40 - 60 HRC	SE 60X per materiali 40 - 60 HRC	SE 60X 可用于 40 - 60 HRC 以下之材料	268
DM 70 (SE 70) for materials 50 - 70 HRC	DM 70 (SE 70) für Materialien 50 - 70 HRC	DM 70 (SE 70) pour matières 50 - 70 HRC	DM 70 (SE 70) per materiali 50 - 70 HRC	DM 70 (SE 70) 可用于 50 - 70 HRC 以下之材料	289
SE GR for milling graphite	SE GR für Graphitbearbeitung	SE GR pour usinage de graphite	SE GR per fresatura in grafite	SE GR 用于石墨加工	326
TE 45 = Die-Sinking Cutters for materials ≤ 45 HRC	TE 45 = Gesenkfräser für Materialien ≤ 45 HRC	TE 45 = Fraises coniques pour matrices pour matières ≤ 45 HRC	TE 45 = Frese coniche per stampi per materiali ≤ 45 HRC	TE 45 = 凹模铣刀 可用于 ≤ 45 HRC 以下之材料	334
Plunge-Mill for materials ≤ 45 HRC	Plunge-Mill für Materialien ≤ 45 HRC	Plunge-Mill pour matières ≤ 45 HRC	Plunge-Mill per materiali ≤ 45 HRC	Plunge-Mill 可用于 ≤ 45 HRC 以下之材料	347
Thread Mill	Thread Mill	Thread Mill	Thread Mill	Thread Mill	351

Table of Content

 Solid Carbide Tools	 VHM Zerspanungs-werkzeuge	 Outils de coupe en carbure monobloc	 Utensili in metallo duro integrale	 钨钢刀具	Page
Ballnose	Radiusschafffräser	Fraises à bout hémisphérique	Frese cilindriche a raggio	球头铣刀	
BN 30 for materials ≤ 35 HRC	BN 30 für Materialien ≤ 35 HRC	BN 30 pour matières ≤ 35 HRC	BN 30 per materiali ≤ 35 HRC	BN 30 可用于 ≤ 35 HRC 以下之材料	356
BN 45 for materials 36 - 50 HRC	BN 45 für Materialien 36 - 50 HRC	BN 45 pour matières 36 - 50 HRC	BN 45 per materiali 36 - 50 HRC	BN 45 可用于 36 - 50 HRC 以下之材料	366
BN 60 for materials 53 - 68 HRC	BN 60 für Materialien 53-68 HRC	BN 60 pour matières 53 - 68 HRC	BN 60 per materiali 53 - 68 HRC	BN 60 可用于 53 - 68 HRC 以下之材料	396
BN 60X for materials 40 - 60 HRC	BN 60X für Materialien 40 - 60 HRC	BN 60X pour matières 40 - 60 HRC	BN 60X per materiali 40 - 60 HRC	BN 60X 可用于 40 - 60 HRC 以下之材料	409
DM 70 (BN 70) for materials 50 - 70 HRC	DM 70 (BN 70) für Materialien 50 - 70 HRC	DM 70 (BN 70) pour matières 50 - 70 HRC	DM 70 (BN 70) per materiali 50 - 70 HRC	DM 70 (BN 70) 可用于 50 - 70 HRC 以下之材料	418
BN GR for milling graphite	BN GR für Graphitbearbeitung	BN GR pour usinage de graphite	BN GR per fresatura in grafite	BN GR 用于石墨加工	435
Drills	Spiralbohrer	Forets hélicoïdaux	Punte elicoidali	钻头	441
RE = Reamers	RE = Reibahlen	RE = alésoirs	RE = alesatori	RE = 铰刀	500
Special	Sonderwerkzeuge	Outils spéciaux	Utensili speciali	特殊工具	508
					522
Icons	Symbole	Symboles	Simboli	图标	524

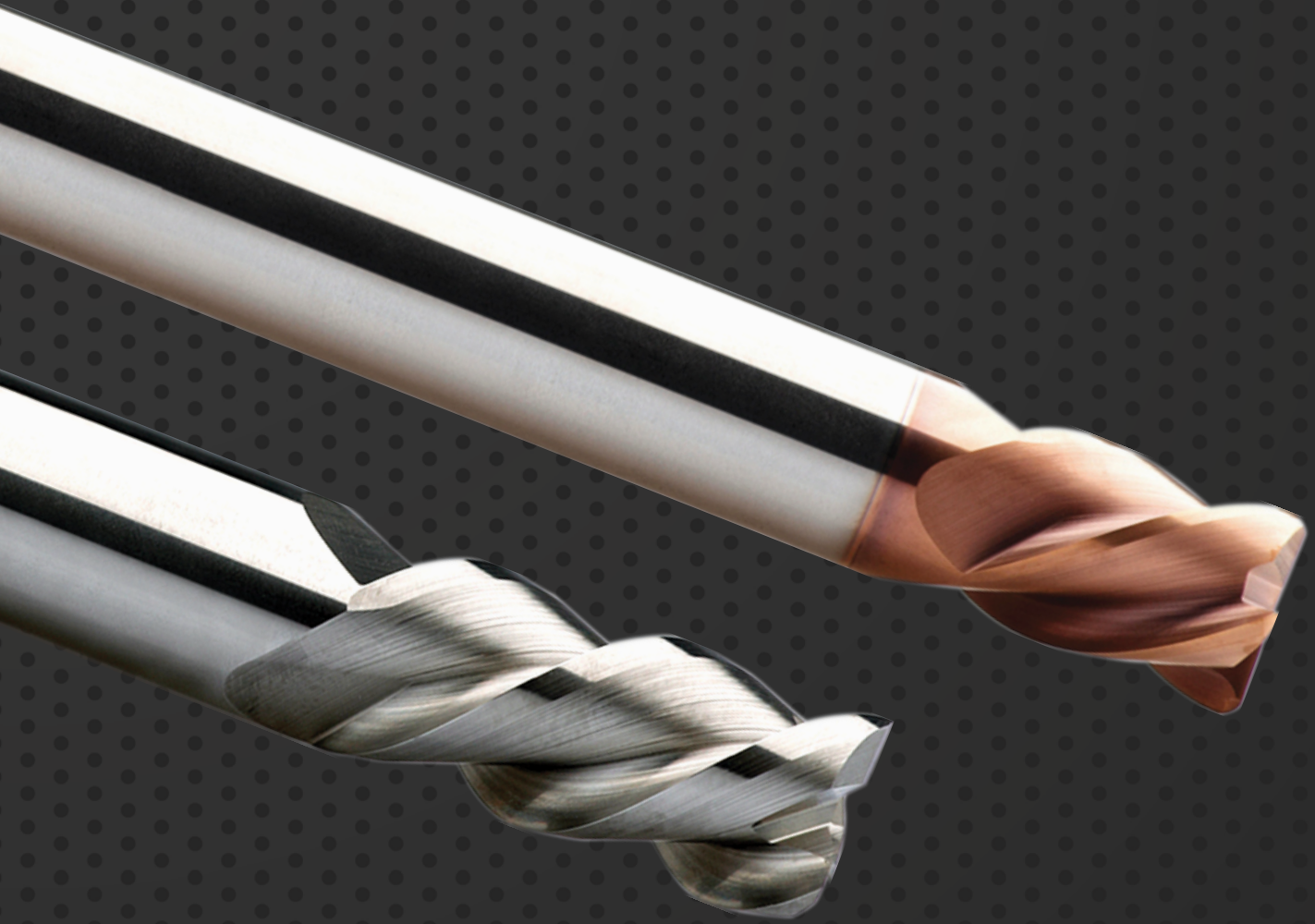

MATERIAL DIRECTORY

ENDMILLS



Please select the material.

		ALU LINE	EZ LINE - ENDMILL	SE 30	NITiCo 30	OPTIMUM	SE 45	SE 45X	NITiCo 45	SE 60	SE 60X	DM70 - SE 70	SE GR	TE 45	PLUNGE-MILL	
		Non Ferrous Metal	≤ 35 HRC	≤ 35 HRC	≤ 45 HRC	≤ 45 HRC	36 - 50 HRC	≤ 52 HRC	36 - 52 HRC	53 - 68 HRC	40 - 60 HRC	50 - 70 HRC	Thermo-plastic & Graphite	≤ 45 HRC	≤ 45 HRC	
N01	Aluminium wrought alloy, Si < 9%	▼	▽	▽		ALL-ROUND OPERATION										
N02	Aluminium cast alloy, Si ≥ 9%	▼	▽	▽												
N03	Copper alloy	▼	▽	▽												
K01	Grey cast iron		▽	▽	▼											▼
K02	Ductile cast iron		▽	▽	▽			▽		▼					▼	
P01	Carbon steel		▽	▽	▼				▼							▼
P02	Alloy steel				▼				▼							▼
P03	Prehardened steel, 35 ≤ HRC < 45							▽	▼	▼		▽			▼	▼
M01	Stainless steel, high machinability		▽		▼											
M02	Stainless steel, low machinability		▽					▽		▼						
S01	Titanium alloy				▼											
S02	Nickel alloy				▽		▽		▼							
S03	Cobalt alloy				▼											
H01	Hardened steel, 45 ≤ HRC < 52						▼	▼		▽	▽	▼		▼		
H02	Hardened steel, ≥ 52HRC									▽	▼	▼				
O01	Thermoplastics	▼														
O02	Graphite												▼			
		17	19	19	19	21	21	27	27	27	29	29	29	31	31	

▼ First Choice

▽ Second Choice

	BALLNOSE						DRILL										
--	----------	--	--	--	--	--	-------	--	--	--	--	--	--	--	--	--	--



THREAD MILL	BN 30	BN 45	BN 60	BN 60X	DM70 - BN 70	BN GR	NC Spot	DR ALU	EZ LINE - DRILL	DR NITiCo	DR VA	DR-S	DR Mini	DR-LX	DR 45 SB	DR 60	RE 45
THREAD MILL	≤ 35 HRC	36 - 50 HRC	53 - 68 HRC	40 - 60 HRC	50 - 70 HRC	Thermo-plastic & Graphite	≤ 35 HRC	Non Ferrous Metal	≤ 35 HRC	≤ 35 HRC	≤ 45 HRC	≤ 45 HRC	≤ 45 HRC	≤ 45 HRC	≤ 45 HRC	≤ 68 HRC	≤ 45 HRC

▼	▽						▼	▼	▼			ALL-ROUND DRILLING	▼	DEEP HOLE DRILLING			▼		
▼	▽						▼	▼	▼						▼				▼
▼	▽						▼	▼	▼						▼				▼
▼	▽	▽					▼	▼	▼						▼				▼
▼	▽	▼					▼	▼	▽						▼				▼
▼	▽	▼					▼	▼	▽						▼				▼
▼	▽	▽					▼	▼	▽						▼				▼
▼	▽	▽		▼			▼	▼	▽						▼				▼
▼	▽	▼					▼	▼	▽						▼				▼
▼	▽	▼					▼	▼	▽						▼				▼
▼	▽	▼					▼	▼	▽				▼				▼		
▼	▽	▼					▼	▼	▽				▼				▼		
▼	▽	▼					▼	▼	▽				▼				▼		
▼	▽	▼					▼	▼	▽				▼				▼		
▼	▽	▼					▼	▼	▽				▼				▼		
▼	▽	▼					▼	▼	▽				▼				▼		
▼	▽	▼					▼	▼	▽				▼				▼		
▼	▽	▼					▼	▼	▽				▼				▼		
▼	▽	▼					▼	▼	▽				▼				▼		
▼	▽	▼				▼	▼	▼	▽				▼				▼		
▼	▽	▼	▽		▼		▼	▼	▽				▼			▼	▼		
▼	▽	▼	▽		▼		▼	▼	▽				▼			▼	▼		
▼	▽	▼	▽		▼		▼	▼	▽				▼			▼	▼		

31	31	33	35	35	35	35	35	35	35	35	35	37	37	37	37	37	37
----	----	----	----	----	----	----	----	----	----	----	----	----	----	----	----	----	----

 **Deutsch**
 **Français**
 **Italiano**
 **中文**

	Materialgruppen	Groupes matière	Gruppi materiali	材质主料
N01	Aluminiumlegierungen, Si < 9%	Alliages d'aluminium, Si < 9%	Leghe di alluminio, Si < 9%	锻造铝合金, Si < 9%
N02	Aluminiumguss, Si ≥ 9%	Avec, Si ≥ 9%	Con, Si ≥ 9%	铣铸造铝合金, Si ≥ 9%
N03	Kupferlegierungen	Cuivres non alliés	Rame senza leghe	铜合金
K01	Grauguss	Gris Fontes	Grigio Ghise	灰色铸铁
K02	Gusseisen	Ductile Fontes	Duttile Ghise	球墨铸铁铸铁
P01	Kohlenstoffstähle	Carbone Aciers	Carbonio Acciai	碳钢材或铸钢
P02	Stahllegierungen	Alliages Aciers	leghe Acciai	合金钢材或铸钢
P03	Vorgehärtete Stähle, 35 ≤ HRC ≤ 45	Préchauffé Aciers, 35 ≤ HRC ≤ 45	Prehardened Acciai, 35 ≤ HRC ≤ 45	预硬化钢材或铸钢, 35 ≤ HRC ≤ 45
M01	Rostfreie Stähle <35 HRC	Aciers inoxydables, Usinabilité élevée	Acciai inossidabili, Elevata Lavorabilità	不锈钢, 沃斯田铁系, 高机械加工性
M02	Rostfreie Stähle ≥35 HRC	Aciers inoxydables, Faible usinabilité	Acciai inossidabili, Bassa ILavorabilità	不锈钢, 沃斯田铁系, 低机械机加工性
S01	Titanlegierungen	Alliages de titane jusqu'à	Leghe di titanio fino	钛合金
S02	Nickellegierungen	Alliages de Ni	Leghe al Ni	镍、钴基
S03	Kobaltlegierungen	Alliages de Co	Leghe al Co	镍、金钢
H01	Gehärtete Stähle, 45 ≤ HRC < 52	Aciers trempés, 45 ≤ HRC < 52	Acciai temperati, 45 ≤ HRC < 52	预硬钢, 洛氏硬度, 45 ≤ HRC < 52
H02	Gehärtete Stähle, ≥ 52 HRC	Aciers trempés, ≥ 52 HRC	Acciai temperati, ≥ 52 HRC	预硬钢, 洛氏硬度, ≥ 52 HRC
O01	Thermoplaste	Thermoplastiques	Termoplastici	热塑性塑料 (无纤维)
O02	Grafit	Graphite	Grafite	石墨

EDP No	Description	Page
186	SE 45 Long	203
202	SE 45 Extra-Long	204
301	AL SE	46
303	AL SE	51
311	SE 45R Torus	207
398	MG Mini 1/4 Corner	104
485	BN 45	376
543	SE 45X DP NEW	236
583	TE 45 0.5° inclination	336
587	TE 45 1.0° inclination	337
591	TE 45 1.5° inclination	338
595	TE 45 2.0° inclination	339
599	TE 45 2.5° inclination	340
603	TE 45 3.0° inclination	341
607	TE 45 4.0° inclination	342
611	TE 45 5.0° inclination	343
615	TE 45 7.0° inclination	344
618	TE 45 10.0° inclination	345
621	RE 45 SHORT	502
623	RE 45 L.H. / R.H. SHORT	503
625	RE 45 R.H. DIN 212	504
627	RE 45 L.H. / R.H. DIN 212	505
629	RE 45 HIGH L.H. / R.H. DIN 212	506
630	SE 45 Short Flute	200
635	SE 45X DP NEW	235
662	DR NC 60°	443
664	DR NC 90°	444
666	DR NC 120°	445
750	SE GR	328
752	SE GR Miniature Long Neck	329
753	SE GR Miniature Long Neck	330
754	BN GR	437
756	BN GR Long Neck	438
786	SE 45R Long Reach Long	211
788	AL SE	44
798	SE 30	93
800	SE 30	94
806	SE 30 Long	95
810	SE 30 Extra-Long	96
813	SE 45R Long Reach Long	212
815	SE 60X	280
816	SE 30	97
818	SE 30	98
821	DR 60 - 5 x Ø	497
823	DR 60 - 3 x Ø	498
824	SE 30 Long	99
828	SE 30 Extra-Long	100
834	SE 30 Multi Propose 60°	101
836	SE 30 Multi Propose 90°	102
838	SE 30 Multi Propose 120°	103

EDP No	Description	Page
851	SE 45	181
855	SE 45 Long	182
859	SE 45 Extra-Long	183
862	SE 45	184
863	SE 45	184
866	SE 45 Long	185
867	SE 45 Long	185
870	SE 45 Extra-Long	186
871	SE 45 Extra-Long	186
883	SE 45 Mini	189
885	SE 45 Miniature Long Neck	190
886	SE 45	201
887	SE 45X DP NEW	235
889	SE 45 Long	203
891	SE 45 Extra-Long	204
893	SE 45 Short Flute	199
895	SE 45 Long Reach Long	205
897	SE 45 Long Reach Long	205
899	SE 45 Long Reach Extra-Long	206
901	SE 45 Long Reach Extra-Long	206
904	SE 45R Torus	207
906	SE 45R Long Reach Long	211
907	SE 45R Long Reach Long	212
908	SE 45R Long Reach Extra-Long	214
909	SE 45R Long Reach Extra-Long	215
918	OPTIMUM DP	165
919	OPTIMUM DP Torus NEW	169
923	BN 30	360
924	AL SE, Flute Polished	44
925	BN 30 Long	361
927	BN 30 Extra-Long	362
929	BN 45	370
931	BN 45 Long	373
933	BN 45 Extra-Long	374
935	BN 45 Mini	380
937	BN 45 Miniature Long Neck	382
940	BN 45	375
941	BN 45	375
942	BN 45 Long	377
943	BN 45 Long	377
944	BN 45 Extra-Long	378
945	BN 45 Extra-Long	379
949	NiTiCo 30 DP/DH	130
951	NiTiCo 30 DP	119
953	DR NC 60°	443
955	DR NC 90°	444
957	DR NC 120°	445
972	NiTiCo 30 DP, Weldon	119
981	OPTIMUM DP NEW	165
991	OPTIMUM DP Torus NEW	169

EDP No	Description	Page
A01	SE 45 Mini	189
A03	SE 45 Miniature Long Neck	190
A04	SE 45	201
A05	SE 45	201
A06	SE 45X DP NEW	235
A07	SE 45X DP NEW	235
A09	SE 45 Long	203
A11	SE 45 Extra-Long	204
A14	SE 45 Short Flute	199
A15	SE 45 Short Flute	199
A18	SE 45 Long Reach Long	205
A19	SE 45 Long Reach Long	205
A22	SE 45 Long Reach Extra-Long	206
A23	SE 45 Long Reach Extra-Long	206
A25	SE 45R Taper Neck	198
A26	SE 45R Torus	208
A28	SE 45R Long Reach Long	211
A29	SE 45R Long Reach Long	212
A30	SE 45R Long Reach Extra-Long	214
A31	SE 45R Long Reach Extra-Long	214
A32	SE 45R Long Reach Extra-Long	215
A33	SE 45R Long Reach Extra-Long	215
A34	SE 60 Short Flute	259
A36	SE 60 Long	253
A37	SE 60 Extra-Long	254
A38	SE 60 Long Reach Long	255
A39	SE 60 Long Reach Long	255
A40	SE 60 Long Reach Extra-Long	256
A41	SE 60 Long Reach Extra-Long	256
A44	SE 60 Multiflute Long	257
A45	SE 60 Multiflute Long	257
A46	SE 60 Multiflute Extra-Long	258
A47	SE 60 Multiflute Extra-Long	258
A48	SE 60R Short Flute	260
A49	SE 60R Short Flute	260
A51	SE 60 Long Reach Long	261
A52	SE 60 Long Reach Long	261
A53	SE 60 Long Reach Extra-Long	262
A54	SE 60 Long Reach Extra-Long	262
A55	SE 60 Mini	263
A57	BN 45	375
A58	BN 45	375
A59	BN 45 Long	377
A60	BN 45 Long	377
A61	BN 45 Extra-Long	378
A62	BN 45 Extra-Long	379
A63	BN 45 Mini	380
A65	BN 45 Miniature Long Neck	381
A71	BN 60 Long	401
A72	BN 60 Long	401

EDP No	Description	Page
A73	BN 60 Extra-Long	402
A74	BN 60 Extra-Long	402
A75	BN 60 Miniature	403
A76	BN 45 Miniature Long Neck	382
A77	BN 60 Taper Neck	404
A78	BN 45 Taper Neck	384
A79	SE 45R Miniature Long Neck Torus	193
A89	SE 45 Multiflute	217
A90	SE 45 Multiflute Long	218
A91	SE 45 Multiflute Extra-Long	219
A94	SE 45 Multiflute	217
A95	SE 45 Multiflute Long	218
A96	SE 45 Multiflute Extra-Long	219
A98	SE 60X	280
A99	SE 45R Long Reach Long	211
A1B	SE 45R Long Reach Long	212
A1L	BN 60	400
A1R	NiTiCo 30 DP/DH	132
A1T	NiTiCo 30 DP/DH, Weldon	133
A4F	SE 60X Fin-Mill Taper Neck	276
A4G	SE 60X Fin-Mill Torus Miniature Long Neck	274
A4Q	BN 60X	413
A4R	BN 60X	413
A4S	BN 60X Miniature Long Neck	414
A5D	SE 70 Miniature Long Neck NEW	302
A5E	SE 70 Miniature Long Neck NEW	304
A5F	SE 70 NEW	295
A5G	SE 70R Miniature Torus Long Neck NEW	307 / 308
A5H	SE 70R Torus NEW	298
A5J	SE 70R Torus NEW	298
A5M	SE 70 NEW	295
A5Q	BN 70 NEW	424
A5R	BN 70 NEW	424
A5S	BN 70 Miniature Long Neck NEW	427
B30	SE 45R Torus	187
B31	SE 45	201
B32	SE 45R Long Reach Extra-Long	214
B33	SE 45R Long Reach Extra-Long	215
B37	TE 45 0.5° inclination	336
B38	TE 45 1.0° inclination	337
B39	TE 45 1.5° inclination	338
B40	TE 45 2.0° inclination	339
B41	TE 45 2.5° inclination	340
B42	TE 45 3.0° inclination	341
B43	TE 45 4.0° inclination	342
B44	TE 45 5.0° inclination	343
B45	TE 45 7.0° inclination	344
B46	TE 45 10.0° inclination	345
B59	SE 45R Torus	187
B66	SE 45R Miniature Long Neck Torus	193

EDP No	Description	Page
B71	SE 45 Multiflute	217
B73	SE 45 Multiflute Long	218
B78	SE 45 Multiflute Extra-Long	219
B82	BN 45	372
B85	BN GR Extra-Long	439
C14	SE 45 Multiflute	217
C15	SE 45 Multiflute Long	218
C16	SE 45 Multiflute Extra-Long	219
C30	NiTiCo 30	112
C31	NiTiCo 30	113
C36	BN 45	370
C42	NiTiCo 30, Weldon	114
C43	NiTiCo 30, Weldon	115
C44	NiTiCo 30, Weldon	116
C45	AL SE DP Torus	57
C46	NiTiCo 30 DP	120
C47	NiTiCo 30 Roughing	136
C48	NiTiCo 30 DP/DH	132
C49	NiTiCo 30 DP/DH, Weldon	130
C50	NiTiCo 30 DP/DH	133
C51	AL SE DP Torus, Weldon	57
C52	NiTiCo 30 DP, Weldon	120
C64	NiTiCo 30 Roughing, Weldon	136
C73	DR VA OF - 3 x Ø	464
C76	EZ DP/DH	NEW 87
C77	DR VA OF - 5 x Ø	465
D07	DR NiTiCo OF - 3 x Ø	459
D08	DR NiTiCo OF - 5 x Ø	460
D09	DR ALU OF - 3 x Ø	449
D10	DR ALU OF - 5 x Ø	450
F33	DR 45 SB OF - 8 x Ø	493
F38	BN 45	NEW 371
G10	PLUNGE-MILL	349
G12	PLUNGE-MILL	349
G38	NiTiCo 45 DP Roughing	245
G41	NiTiCo 45 DP Roughing	245
G44	NiTiCo 45 DP Roughing, Weldon	245
G47	NiTiCo 45 DP Roughing, Weldon	245
G49	AL SE	45
G50	AL SE	50
G51	AL SE Long	53
G52	AL SE Torus, Edge Protection, Flute Polished	47
G53	AL SE Torus, Edge Protection, Flute Polished	47
G56	AL SE Long Torus, Edge Protection, Flute Polished	48
G57	AL SE Long Torus, Edge Protection, Flute Polished	48
G68	AL SE Miniature Long Neck	68
G69	AL SE DP, Edge Protection	54
G70	AL SE DP, Edge Protection	54
G71	AL SE Reduced Shank	49
G72	AL SE DP Torus Roughing	55

EDP No	Description	Page
G73	AL SE DP Torus Roughing	55
G74	AL BN	70
G75	AL BN	70
G76	AL BN Miniature Long Neck	71
G78	SE 60X Fin-Mill Torus	272
G80	SE 60X Fin-Mill Torus	272
G82	SE 60X Fin-Mill Torus Long	273
G84	SE 60X Fin-Mill Torus Long	273
G86	SE 60X Sweep-Mill	283
G87	NiTiCo 30 Miniature Long Neck	137
G88	NiTiCo 30 Miniature Long Neck	141
H03	DR MINI - 5 x Ø, 8x Ø, 12 x Ø, 15x Ø, 20x Ø, 25x Ø, 30x Ø	479
H15	Thread Mill M, With Internal Oil Hole	354
H17	Thread Mill MF, With Internal Oil Hole	354
H19	Thread Mill M, Without Internal Oil Hole	353
H21	Thread Mill MF, Without Internal Oil Hole	353
H38	NiTiCo 30 DP/DH Long	135
H39	NiTiCo 30 DP/DH Long, Weldon	135
H56	NiTiCo 30 Miniature Long Neck	139
H86	SE GR Torus Miniature Long Neck	332
H98	NiTiCo 30 DP/DH, Weldon	134
J01	NiTiCo 30 DP/DH, Weldon	134
J86	SE GR Torus Miniature Long Neck	331
J89	NiTiCo 30 DH	122
J90	NiTiCo 30 DH, Weldon	122
J92	NiTiCo 30 DH Long	123
J93	NiTiCo 30 DH Long, Weldon	123
J97	NiTiCo 30 DP/DH Long	135
J98	NiTiCo 30 DP/DH Long, Weldon	135
K30	AL SE DP	52
K31	AL SE DP	52
K38	OPTIMUM R-LIKE DP	166
K47	OPTIMUM R-LIKE DP, Weldon	166
K52	OPTIMUM R-LIKE DP	166
K53	OPTIMUM R-LIKE DP, Weldon	166
K60	XQ Alu DP/DH/DF	NEW 60
K61	XQ Alu DP/DH/DF Chip Breaker	NEW 61
K62	XQ Alu Torus DP/DH/DF	NEW 64
K63	XQ Alu Torus DP/DH/DF, Chip Breaker	NEW 65
K65	NiTiCo 30 DH Internal Oil Hole, Weldon, Recess	NEW 126
K67	NiTiCo 30 DH Long Internal Oil Hole, Weldon, Recess	NEW 127
K70	NiTiCo 30 DP/DH Internal Oil Hole, Weldon, Recess	NEW 131
K73	SE 70 DH Multiflutes Torus	NEW 313
K76	SE 70 DH Multiflutes	NEW 316
K77	SE 70 DH Multiflutes	NEW 316
K78	NiTiCo 30 DP/DH, Weldon	NEW 131
K88	XQ Alu Long DP/DH/DF	NEW 66
K89	XQ Alu Long DP/DH/DF, Chip Breaker	NEW 67
K92	NiTiCo 45 DP/DH	NEW 242
K93	NiTiCo 45 DP/DH	NEW 242

Index by Series



EDP Number	Type Typ Type Tipo 系列			N° Z	Helix Angle	Coating	Recess
788	Alu Line Non Ferrous Metal		AL SE	1	25°	UC	
924			AL SE, Flute Polished	1	25°	UC	
G49			AL SE	2	40°	UC	
301			AL SE	2	50°	UC	
G52			AL SE Torus, Edge Protection, Flute Polished	2	30°	UC	
G53			AL SE Torus, Edge Protection, Flute Polished	2	30°	UC	•
G56			AL SE Long Torus, Edge Protection, Flute Polished	2	30°	UC	
G57			AL SE Long Torus, Edge Protection, Flute Polished	2	30°	UC	•
G71			AL SE Reduced Shank	2	30°	UC	
G50			AL SE	3	40°	UC	
303			AL SE	3	50°	UC	
K30			AL SE DP	3	40°	UC	
K31			AL SE DP	3	40°	H2600	
G51			AL SE Long	3	40°	UC	
G69			AL SE DP, Edge Protection	3	30°	UC	
G70			AL SE DP, Edge Protection	3	30°	UC	
G72			AL SE DP Torus Roughing	3	40°	UC	
G73			AL SE DP Torus Roughing	3	40°	UC	•
S42			AL SE DP	4	40°	UC	
C45			AL SE DP Torus	4	40°	UC	
C51			AL SE DP Torus, Weldon	4	40°	UC	
K60		NEW	XQ Alu DP/DH/DF	4	a° ≠ b°	UC	•
K61		NEW	XQ Alu DP/DH/DF Chip Breaker	4	a° ≠ b°	UC	•
K62		NEW	XQ Alu Torus DP/DH/DF	4	a° ≠ b°	UC	•
K63		NEW	XQ Alu Torus DP/DH/DF, Chip Breaker	4	a° ≠ b°	UC	•
K88		NEW	XQ Alu Long DP/DH/DF	4	a° ≠ b°	UC	•
K89		NEW	XQ Alu Long DP/DH/DF, Chip Breaker	4	a° ≠ b°	UC	•
G68			AL SE Miniature Long Neck	2	40°	UC	
G74			AL BN	2	30°	UC	
G75			AL BN	2	30°	UC	•
G76			AL BN Miniature Long Neck	2	30°	UC	

Application				Working Material																Page / Seite / 页			
				P			M		K		N			S			H		O				
				P01	P02	P03	M01	M02	K01	K02	N01	N02	N03	S01	S02	S03	H01	H02	O01		O02		
				Carbon steel	Alloy steel	Prehardened steel, 35 ≤ HRC < 45	Stainless steel, high machinability	Stainless steel, low machinability	Grey cast iron	Ductile cast iron	Aluminum wrought alloy, Si < 9%	Aluminum cast alloy, Si ≥ 9%	Copper alloy	Titanium alloy	Nickel alloy	Cobalt alloy	Hardened steel, 45 ≤ HRC < 52	Hardened steel, ≥ 52 HRC	Thermoplastics	Graphite			
•											•	•	•							•		44	
•											•	•	•								•		44
•	•										•	•	•								•		45
•	•										•	•	•								•		46
•	•										•	•	•								•		47
•	•										•	•	•								•		47
•											•	•	•								•		48
•											•	•	•								•		48
•	•										•	•	•								•		49
•	•										•	•	•								•		50
•	•										•	•	•								•		51
•	•										•	•	•								•		52
•	•										•	•	•								•		52
•											•	•	•								•		53
•	•										•	•	•								•		54
•	•										•	•	•								•		54
•	•										•	•	•								•		55
•	•										•	•	•								•		55
•	•										•	•	•								•		56
•	•										•	•	•								•		57
•	•										•	•	•								•		57
•	•										•	•	•								•		60
•	•										•	•	•								•		61
•	•										•	•	•								•		64
•	•										•	•	•								•		65
•											•	•	•								•		66
•											•	•	•								•		67
•											•	•	•								•		68
											•	•	•								•		70
											•	•	•								•		70
											•	•	•								•		71

Index by Series

EDP Number	Type Typ Type Tipo 系列				N° Z	Helix Angle	Coating	Recess	
C76	EZ ENDMILLS	NEW		EZ DP/DH	4	a° ≠ b°	G6110		
798	SE 30 ≤ 35 HRC			SE 30	2	30°	B0819		
800				SE 30	3	30°	B0819		
806				SE 30 Long	4	30°	B0819		
810				SE 30 Extra-Long	4	30°	B0819		
816				SE 30	2	40°	B0819		
818				SE 30	3	40°	B0819		
824				SE 30 Long	4	40°	B0819		
828				SE 30 Extra-Long	4	40°	B0819		
834				SE 30 Multi Propose 60°	2	40°	B0819		
836				SE 30 Multi Propose 90°	2	40°	B0819		
838				SE 30 Multi Propose 120°	2	40°	B0819		
398				MG Mini 1/4 Corner	4	-	B0819		
C30		NiTiCo 30 ≤ 45 HRC			NiTiCo 30	2	30°	G6110	
C31					NiTiCo 30	3	30°	G6110	
C42				NiTiCo 30, Weldon	2	30°	G6110		
C43				NiTiCo 30, Weldon	3	30°	G6110		
C44				NiTiCo 30, Weldon	4	30°	G6110		
951				NiTiCo 30 DP	4	40°	G6110		
972				NiTiCo 30 DP, Weldon	4	40°	G6110		
C46				NiTiCo 30 DP	4	40°	G6110		
C52				NiTiCo 30 DP, Weldon	4	40°	G6110		
J89				NiTiCo 30 DH	5	a° ≠ b°	G6110		
J90				NiTiCo 30 DH, Weldon	5	a° ≠ b°	G6110		
J92				NiTiCo 30 DH Long	5	a° ≠ b°	G6110		
J93				NiTiCo 30 DH Long, Weldon	5	a° ≠ b°	G6110		
K65	NEW			NiTiCo 30 DH Standard Internal Oil Hole, Weldon, Recess	5	a° ≠ b°	G6110	•	
K67	NEW			NiTiCo 30 DH Long Internal Oil Hole, Weldon, Recess	5	a° ≠ b°	G6110	•	
949	NEW			NiTiCo 30 DP/DH	4	a° ≠ b°	G6110		
C49	NEW			NiTiCo 30 DP/DH, Weldon	4	a° ≠ b°	G6110		
K78	NEW		NiTiCo 30 DP/DH, Weldon	4	a° ≠ b°	G6110	•		

Application				Working Material																Page / Seite / 页		
				P			M		K		N			S			H		O			
				P01	P02	P03	M01	M02	K01	K02	N01	N02	N03	S01	S02	S03	H01	H02	O01		O02	
				Carbon steel	Alloy steel	Prehardened steel, 35 ≤ HRC < 45	Stainless steel, high machinability	Stainless steel, low machinability	Grey cast iron	Ductile cast iron	Aluminum wrought alloy, Si < 9%	Aluminum cast alloy, Si ≥ 9%	Copper alloy	Titanium alloy	Nickel alloy	Cobalt alloy	Hardened steel, 45 ≤ HRC < 52	Hardened steel, ≥ 52 HRC	Thermoplastics	Graphite		
•	•			○			○	○	○	○	○	○										87
•	•			○					○		○	○										93
•	•			○					○		○	○										94
•				○					○		○	○										95
•				○					○		○	○										96
•	•			○					○		○	○										97
•	•			○					○		○	○										98
•				○					○		○	○										99
•				○					○		○	○										100
	Chamfering			○					○		○	○										101
	Chamfering			○					○		○	○										102
	Chamfering			○					○		○	○										103
•				○					○		○	○										104
•	•			•	•		•		•	○				•	○	•						112
•	•			•	•		•		•	○				•	○	•						113
•	•			•	•		•		•	○				•	○	•						114
•	•			•	•		•		•	○				•	○	•						115
•	•			•	•		•		•	○				•	○	•						116
•	•			•	•		•		•	○				•	○	•						119
•	•			•	•		•		•	○				•	○	•						119
•	•			•	•		•		•	○				•	○	•						120
•	•			•	•		•		•	○				•	○	•						120
•		•		•	•		•		•	○				•	○	•						122
•		•		•	•		•		•	○				•	○	•						122
•		•		•	•		•		•	○				•	○	•						123
•		•		•	•		•		•	○				•	○	•						123
•		•		•	•		•		•	○				•	○	•						126
•		•		•	•		•		•	○				•	○	•						127
•		•		•	•		•		•	○				•	○	•						130
•		•		•	•		•		•	○				•	○	•						130
•		•		•	•		•		•	○				•	○	•						131

Index by Series

EDP Number	Type Typ Type Tipo 系列				N° Z	Helix Angle	Coating	Recess	
K70	NiTiCo 30 ≤ 45 HRC	NEW		NiTiCo 30 DP/DH Internal Oil Hole, Weldon, Recess	4	a° ≠ b°	G6110	•	
C48				NiTiCo 30 DP/DH	4	a° ≠ b°	G6110		
H98		NEW		NiTiCo 30 DP/DH, Weldon	4	a° ≠ b°	G6110	•	
C50				NiTiCo 30 DP/DH	4	a° ≠ b°	G6110		
J01		NEW		NiTiCo 30 DP/DH, Weldon	4	a° ≠ b°	G6110	•	
A1R				NiTiCo 30 DP/DH	4	a° ≠ b°	B0909		
A1T				NiTiCo 30 DP/DH, Weldon	4	a° ≠ b°	B0909		
H38				NiTiCo 30 DP/DH Long	4	a° ≠ b°	G6110	•	
H39				NiTiCo 30 DP/DH Long, Weldon	4	a° ≠ b°	G6110	•	
J97				NiTiCo 30 DP/DH Long	4	a° ≠ b°	G6110		
J98				NiTiCo 30 DP/DH Long, Weldon	4	a° ≠ b°	G6110		
C47				NiTiCo 30 Roughing	4	40°	G6110		
C64				NiTiCo 30 Roughing, Weldon	4	40°	G6110		
G87				NiTiCo 30 Miniature Long Neck	4	40°	G6110		
G88				NiTiCo 30 Miniature Long Neck	4	30°	G6110		
H56				NiTiCo 30 Miniature Long Neck	4	40°	G6110		
918		Optimum ≤ 45 HRC			OPTIMUM DP	4	40°	G6110	
981			NEW		OPTIMUM DP	4	40°	G6110	•
K38					OPTIMUM R-LIKE DP	4	40°	G6110	
K52					OPTIMUM R-LIKE DP	4	40°	G6110	•
K47				OPTIMUM R-LIKE DP, Weldon	4	40°	G6110		
K53				OPTIMUM R-LIKE DP, Weldon	4	40°	G6110	•	
919	NEW			OPTIMUM DP Torus	4	40°	G6110		
991	NEW			OPTIMUM DP Torus	4	40°	G6110	•	
851	SE 45 36 - 50 HRC			SE 45	4	30°	B0819		
855				SE 45 Long	4	30°	B0819		
859				SE 45 Extra-Long	4	30°	B0819		
862				SE 45	4	40°	G6110		
863				SE 45	4	40°	B0819		
866				SE 45 Long	4	40°	G6110		
867				SE 45 Long	4	40°	B0819		

Application				Working Material																Page / Seite / 页		
				P			M		K		N			S			H		O			
				P01	P02	P03	M01	M02	K01	K02	N01	N02	N03	S01	S02	S03	H01	H02	O01		O02	
				Carbon steel	Alloy steel	Prehardened steel, 35 ≤ HRC < 45	Stainless steel, high machinability	Stainless steel, low machinability	Grey cast iron	Ductile cast iron	Aluminum wrought alloy, Si < 9%	Aluminum cast alloy, Si ≥ 9%	Copper alloy	Titanium alloy	Nickel alloy	Cobalt alloy	Hardened steel, 45 ≤ HRC < 52	Hardened steel, ≥ 52 HRC	Thermoplastics	Graphite		
•		•		•	•	•	•	•	•	•				•	•	•						131
•	•			•	•	•	•	•	•	•				•	•	•						132
•	•			•	•	•	•	•	•	•				•	•	•						134
•	•			•	•	•	•	•	•	•				•	•	•						133
•	•			•	•	•	•	•	•	•				•	•	•						134
•	•			•	•	•	•	•	•	•				•	•	•						132
•	•			•	•	•	•	•	•	•				•	•	•						133
•				•	•	•	•	•	•	•				•	•	•						135
•				•	•	•	•	•	•	•				•	•	•						135
•				•	•	•	•	•	•	•				•	•	•						135
•	•			•	•	•	•	•	•	•				•	•	•						136
•	•			•	•	•	•	•	•	•				•	•	•						136
	•			•	•	•	•	•	•	•				•	•	•						137
	Profiling			•	•	•	•	•	•	•				•	•	•						141
	•			•	•	•	•	•	•	•				•	•	•						139
•	•	•	•	•	•	•	•	•	•	•	•	•	•	•	•	•						165
•	•	•	•	•	•	•	•	•	•	•	•	•	•	•	•	•						165
•	•	•	•	•	•	•	•	•	•	•	•	•	•	•	•	•						166
•	•	•	•	•	•	•	•	•	•	•	•	•	•	•	•	•						166
•	•	•	•	•	•	•	•	•	•	•	•	•	•	•	•	•						166
•	•	•	•	•	•	•	•	•	•	•	•	•	•	•	•	•						166
•	•	•	•	•	•	•	•	•	•	•	•	•	•	•	•	•						169
•	•	•	•	•	•	•	•	•	•	•	•	•	•	•	•	•						169
•	•					•	•	•	•	•				•	•	•						181
•						•	•	•	•	•				•	•	•						182
•						•	•	•	•	•				•	•	•						183
•	•					•	•	•	•	•				•	•	•						184
•	•					•	•	•	•	•				•	•	•						184
•	•					•	•	•	•	•				•	•	•						185
•	•					•	•	•	•	•				•	•	•						185

Index by Series



EDP Number	Type Typ Type Tipo 系列			N° Z	Helix Angle	Coating	Recess
870	SE 45 36 - 50 HRC		SE 45 Extra-Long	4	40°	G6110	
871			SE 45 Extra-Long	4	40°	B0819	
B30			SE 45R Torus	4	40°	B0819	
B59			SE 45R Torus	4	40°	B0819	
883			SE 45 Mini	2	40°	B0819	
A01			SE 45 Mini	2	40°	B0909	
885			SE 45 Miniature Long Neck	2	40°	B0819	
A03			SE 45 Miniature Long Neck	2	40°	B0909	
B66			SE 45R Miniature Long Neck Torus	2	40°	B0819	
A79			SE 45R Miniature Long Neck Torus	2	40°	B0909	
A25			SE 45R Taper Neck	2	40°	B0909	
630			SE 45 Short Flute	3	40°	B0819	•
893			SE 45 Short Flute	3	40°	B0819	
A14			SE 45 Short Flute	3	40°	B0909	
A15			SE 45 Short Flute	3	40°	B0909	•
886			SE 45	2	40°	B0819	
B31			SE 45	2	40°	B0819	•
A04			SE 45	2	40°	B0909	
A05			SE 45	2	40°	B0909	•
186			SE 45 Long	4	40°	G6110	
889			SE 45 Long	4	40°	B0819	
A09			SE 45 Long	4	40°	B0909	
202			SE 45 Extra-Long	4	40°	G6110	
891			SE 45 Extra-Long	4	40°	B0819	
A11			SE 45 Extra-Long	4	40°	B0909	
895			SE 45 Long Reach Long	4	40°	B0819	
897			SE 45 Long Reach Long	4	40°	B0819	•
A18			SE 45 Long Reach Long	4	40°	B0909	
A19			SE 45 Long Reach Long	4	40°	B0909	•
899			SE 45 Long Reach Extra-Long	4	40°	B0819	
901		SE 45 Long Reach Extra-Long	4	40°	B0819	•	





Application				Working Material																Page / Seite / 页		
				P			M		K		N			S			H		O			
				P01	P02	P03	M01	M02	K01	K02	N01	N02	N03	S01	S02	S03	H01	H02	O01		O02	
				Carbon steel	Alloy steel	Prehardened steel, 35 ≤ HRC < 45	Stainless steel, high machinability	Stainless steel, low machinability	Grey cast iron	Ductile cast iron	Aluminum wrought alloy, Si < 9%	Aluminum cast alloy, Si ≥ 9%	Copper alloy	Titanium alloy	Nickel alloy	Cobalt alloy	Hardened steel, 45 ≤ HRC < 52	Hardened steel, ≥ 52 HRC	Thermoplastics	Graphite		
•						○	○	○								○	•					186
•						○	○	○								○	•					186
•	•					○	○	○								○	•					187
•	•					○	○	○								○	•					187
						○	○	○								○	•					189
						○	○	○								○	•					189
						○	○	○								○	•					190
						○	○	○								○	•					190
						○	○	○								○	•					193
						○	○	○								○	•					193
						○	○	○								○	•					198
•	•					○	○	○								○	•					199
•	•					○	○	○								○	•					199
•	•					○	○	○								○	•					199
•	•					○	○	○								○	•					199
•						○	○	○								○	•					201
						○	○	○								○	•					201
						○	○	○								○	•					201
						○	○	○								○	•					201
•						○	○	○								○	•					203
•						○	○	○								○	•					203
•						○	○	○								○	•					203
•						○	○	○								○	•					204
•						○	○	○								○	•					204
•						○	○	○								○	•					204
•						○	○	○								○	•					205
•						○	○	○								○	•					205
•						○	○	○								○	•					205
•						○	○	○								○	•					205
•						○	○	○								○	•					206
•						○	○	○								○	•					206

Index by Series



EDP Number	Type Typ Type Tipo 系列			N° Z	Helix Angle	Coating	Recess
A22	SE 45 36 - 50 HRC		SE 45 Long Reach Extra-Long	4	40°	B0909	
A23			SE 45 Long Reach Extra-Long	4	40°	B0909	•
311			SE 45R Torus	4	40°	G6110	
904			SE 45R Torus	4	40°	B0819	
A26			SE 45R Torus	4	40°	B0909	
786			SE 45R Long Reach Long	2	40°	B0819	•
906			SE 45R Long Reach Long	2	40°	B0819	
A28			SE 45R Long Reach Long	2	40°	B0909	
A99			SE 45R Long Reach Long	2	40°	B0909	•
813			SE 45R Long Reach Long	4	40°	B0819	•
907			SE 45R Long Reach Long	4	40°	B0819	
A1B			SE 45R Long Reach Long	4	40°	B0909	•
A29			SE 45R Long Reach Long	4	40°	B0909	
908			SE 45R Long Reach Extra-Long	2	40°	B0819	
B32			SE 45R Long Reach Extra-Long	2	40°	B0819	•
A30			SE 45R Long Reach Extra-Long	2	40°	B0909	
A31			SE 45R Long Reach Extra-Long	2	40°	B0909	•
909			SE 45R Long Reach Extra-Long	4	40°	B0819	
B33			SE 45R Long Reach Extra-Long	4	40°	B0819	
A32			SE 45R Long Reach Extra-Long	4	40°	B0909	
A33			SE 45R Long Reach Extra-Long	4	40°	B0909	•
B71			SE 45 Multiflute	6/8	50°	B0819	
C14			SE 45 Multiflute	6/8	50°	B0819	•
A89			SE 45 Multiflute	6/8	50°	B0909	
A94			SE 45 Multiflute	6/8	50°	B0909	•
B73			SE 45 Multiflute Long	6/8	50°	B0819	
C15			SE 45 Multiflute Long	6/8	50°	B0819	•
A90			SE 45 Multiflute Long	6/8	50°	B0909	
A95			SE 45 Multiflute Long	6/8	50°	B0909	•
B78			SE 45 Multiflute Extra-Long	6/8	50°	B0819	
C16		SE 45 Multiflute Extra-Long	6/8	50°	B0819	•	

Index by Series

Application				Working Material																Page / Seite / 页		
				P			M		K		N			S			H		O			
				P01	P02	P03	M01	M02	K01	K02	N01	N02	N03	S01	S02	S03	H01	H02	O01		O02	
				Carbon steel	Alloy steel	Prehardened steel, 35 ≤ HRC < 45	Stainless steel, high machinability	Stainless steel, low machinability	Grey cast iron	Ductile cast iron	Aluminum wrought alloy, Si < 9%	Aluminum cast alloy, Si ≥ 9%	Copper alloy	Titanium alloy	Nickel alloy	Cobalt alloy	Hardened steel, 45 ≤ HRC < 52	Hardened steel, ≥ 52 HRC	Thermoplastics	Graphite		
•						○	○		○							○		•				206
•						○	○		○							○		•				206
•	•					○	○		○							○		•				207
•	•					○	○		○							○		•				207
•	•					○	○		○							○		•				208
•	•					○	○		○							○		•				211
•	•					○	○		○							○		•				211
•	•					○	○		○							○		•				211
•	•					○	○		○							○		•				211
•	•					○	○		○							○		•				212
•	•					○	○		○							○		•				212
•	•					○	○		○							○		•				212
•	•					○	○		○							○		•				212
•	•					○	○		○							○		•				212
•	•					○	○		○							○		•				214
•	•					○	○		○							○		•				214
•	•					○	○		○							○		•				214
•	•					○	○		○							○		•				214
•	•					○	○		○							○		•				214
•	•					○	○		○							○		•				215
•	•					○	○		○							○		•				215
•	•					○	○		○							○		•				215
•	•					○	○		○							○		•				215
•						○	○		○							○		•				217
•						○	○		○							○		•				217
•						○	○		○							○		•				217
•						○	○		○							○		•				217
•						○	○		○							○		•				218
•						○	○		○							○		•				218
•						○	○		○							○		•				218
•						○	○		○							○		•				218
•						○	○		○							○		•				219
•						○	○		○							○		•				219

Index by Series

EDP Number	Type Typ Type Tipo 系列			N° Z	Helix Angle	Coating	Recess
A91	SE 45 36 - 50 HRC		SE 45 Multiflute Extra-Long	6/8	50°	B0909	
A96			SE 45 Multiflute Extra-Long	6/8	50°	B0909	•
887	SE 45X ≤ 52 HRC		SE 45X DP	4	40°	B0819	
543			SE 45X DP	4	40°	G6110	
635			SE 45X DP	4	40°	B0819	•
A06			SE 45X DP	4	40°	B0909	
A07			SE 45X DP	4	40°	B0909	•
K92	NiTiCo 45 36 - 52 HRC		NiTiCo 45 DP/DH	4	a° ≠ b°	G6110	
K93			NiTiCo 45 DP/DH	4	a° ≠ b°	G6110	•
K94			NiTiCo 45 DP/DH, Weldon	4	a° ≠ b°	G6110	
K95			NiTiCo 45 DP/DH, Weldon	4	a° ≠ b°	G6110	•
K96			NiTiCo 45 DP/DH Torus	4	a° ≠ b°	G6110	
K97			NiTiCo 45 DP/DH Torus	4	a° ≠ b°	G6110	•
K98			NiTiCo 45 DP/DH Torus, Weldon	4	a° ≠ b°	G6110	
K99			NiTiCo 45 DP/DH Torus, Weldon	4	a° ≠ b°	G6110	•
G38			NiTiCo 45 DP Roughing	4	40°	G6110	
G41			NiTiCo 45 DP Roughing	4	40°	G6110	•
G44		NiTiCo 45 DP Roughing, Weldon	4	40°	G6110		
G47		NiTiCo 45 DP Roughing, Weldon	4	40°	G6110	•	
A36	SE 60 53 - 68 HRC		SE 60 Long	4	40°	B0909	
A37			SE 60 Extra-Long	4	40°	B0909	
A38			SE 60 Long Reach Long	4	40°	B0909	
A39			SE 60 Long Reach Long	4	40°	B0909	•
A40			SE 60 Long Reach Extra-Long	4	40°	B0909	
A41			SE 60 Long Reach Extra-Long	4	40°	B0909	•
A44			SE 60 Multiflute Long	6/8	50°	B0909	
A45			SE 60 Multiflute Long	6/8	50°	B0909	•
A46			SE 60 Multiflute Extra-Long	6/8	50°	B0909	
A47			SE 60 Multiflute Extra-Long	6/8	50°	B0909	•
A34			SE 60 Short Flute	4	45°	B0909	
A48			SE 60R Short Flute	4	45°	B0909	

Application				Working Material																Page / Seite / 页		
				P			M		K		N			S			H		O			
				P01	P02	P03	M01	M02	K01	K02	N01	N02	N03	S01	S02	S03	H01	H02	O01		O02	
				Carbon steel	Alloy steel	Prehardened steel, 35 ≤ HRC < 45	Stainless steel, high machinability	Stainless steel, low machinability	Grey cast iron	Ductile cast iron	Aluminum wrought alloy, Si < 9%	Aluminum cast alloy, Si ≥ 9%	Copper alloy	Titanium alloy	Nickel alloy	Cobalt alloy	Hardened steel, 45 ≤ HRC < 52	Hardened steel, ≥ 52 HRC	Thermoplastics	Graphite		
•						○	○		○							○		•				219
•						○	○		○							○		•				219
•				•	•	•												•				235
•				•	•	•												•				236
•				•	•	•												•				235
•				•	•	•												•				235
•	•					•	•		•								•					242
•	•					•	•		•								•					242
•	•					•	•		•								•					242
•	•					•	•		•								•					242
•	•					•	•		•								•					243
•	•					•	•		•								•					243
•	•					•	•		•								•					243
•	•					•	•		•								•					243
•						•	•		•								•					245
•						•	•		•								•					245
•						•	•		•								•					245
•						•	•		•								•					245
•																	○	○				253
•																	○	○				254
•																	○	○				255
•																	○	○				255
•																	○	○				256
•																	○	○				256
•																	○	○				257
•																	○	○				257
•																	○	○				258
•																	○	○				258
•																	○	○				259
•																	○	○				260

Index by Series



EDP Number	Type Typ Type Tipo 系列			N° Z	Helix Angle	Coating	Recess
A49	SE 60 53 - 68 HRC		SE 60R Short Flute	4	45°	B0909	•
A51			SE 60R Long Reach Long	4	40°	B0909	
A52			SE 60R Long Reach Long	4	40°	B0909	•
A53			SE 60R Long Reach Extra-Long	4	40°	B0909	
A54			SE 60R Long Reach Extra-Long	4	40°	B0909	•
A55			SE 60 Mini	2	40°	B0909	
G78	SE 60X 40 - 60 HRC		SE 60X Fin-Mill Torus	4/6	25°	B0909	
G80			SE 60X Fin-Mill Torus	4/6	25°	B0909	•
G82			SE 60X Fin-Mill Torus Long	4/6	25°	B0909	
G84			SE 60X Fin-Mill Torus Long	4/6	25°	B0909	•
A4G			SE 60X Fin-Mill Torus Miniature Long Neck	2/4	25°	B0909	
A4F			SE 60X Fin-Mill Taper Neck	4	25°	B0909	
815			SE 60X	4	25°	G6110	•
A98			SE 60X	4	25°	B0909	•
G86			SE 60X Sweep-Mill	4/6	3°	B0909	•
A5F			SE 70	4	43°	B0909+	
A5M		SE 70	4	43°	B0909+	•	
A5H		SE 70R Torus	4	30°	B0909+		
A5J		SE 70R Torus	4	30°	B0909+	•	
A5D		SE 70 Miniature Long Neck	2	30°	B0909+		
A5E		SE 70 Miniature Long Neck	4	30°	B0909+		
A5G		SE 70R Miniature Torus Long Neck	2/4	30°	B0909+		
K73		SE 70 DH Multiflutes Torus	6/7	a° ≠ b°	B0909		
K76		SE 70 DH Multiflutes	6/7	a° ≠ b°	B0909	•	
K77		SE 70 DH Multiflutes	6/7	a° ≠ b°	B0909	•	
750	SE GR Thermoplastic & Graphite		SE GR	4	40°	DCT01	
752			SE GR Miniature Long Neck	2	40°	DCT01	
753			SE GR Miniature Long Neck	4	40°	DCT01	
H86			SE GR Torus Miniature Long Neck	4	40°	DCT01	
J86			SE GR Torus Miniature Long Neck	2	40°	DCT01	

Application				Working Material																Page / Seite / 页			
				P			M		K		N			S			H		O				
				P01	P02	P03	M01	M02	K01	K02	N01	N02	N03	S01	S02	S03	H01	H02	O01		O02		
				Carbon steel	Alloy steel	Prehardened steel, 35 ≤ HRC < 45	Stainless steel, high machinability	Stainless steel, low machinability	Grey cast iron	Ductile cast iron	Aluminum wrought alloy, Si < 9%	Aluminum cast alloy, Si ≥ 9%	Copper alloy	Titanium alloy	Nickel alloy	Cobalt alloy	Hardened steel, 45 ≤ HRC < 52	Hardened steel, ≥ 52 HRC	Thermoplastics	Graphite			
•																	○	○				260	
•																		○	○				261
•																		○	○				261
•																		○	○				262
•																		○	○				262
	•																	○	○				263
		Face Milling				○												○	●				272
		Face Milling				○												○	●				272
		Face Milling				○												○	●				273
		Face Milling				○												○	●				273
	•					○												○	●				274
	•					○												○	●				278
		Roughing & Finishing				○												○	●				280
		Roughing & Finishing				○												○	●				280
		Face Milling				○												○	●				283
•																		●	●				295
•																		●	●				295
•																		●	●				298
•																		●	●				298
	•																	●	●				302
	•																	●	●				304
	•																	●	●				307 / 308
•																		●	●				313
•																		●	●				316
•																		●	●				316
•	•																					●	328
•																						●	329
•																						●	330
•																						●	332
•																						●	331

EDP Number	Type Typ Type Tipo 系列				N° Z	Helix Angle	Coating	Recess
583	TE 45 ≤ 45 HRC		TE 45 0.5° inclination		3/4	40°	UC	
B37			TE 45 0.5° inclination		3/4	40°	B0819	
587			TE 45 1.0° inclination		3/4	40°	UC	
B38			TE 45 1.0° inclination		3/4	40°	B0819	
591			TE 45 1.5° inclination		3/4	40°	UC	
B39			TE 45 1.5° inclination		3/4	40°	B0819	
595			TE 45 2.0° inclination		3/4	40°	UC	
B40			TE 45 2.0° inclination		3/4	40°	B0819	
599			TE 45 2.5° inclination		3/4	40°	UC	
B41			TE 45 2.5° inclination		3/4	40°	B0819	
603			TE 45 3.0° inclination		3/4	40°	UC	
B42			TE 45 3.0° inclination		3/4	40°	B0819	
607			TE 45 4.0° inclination		3/4	40°	UC	
B43			TE 45 4.0° inclination		3/4	40°	B0819	
611			TE 45 5.0° inclination		3/4	40°	UC	
B44			TE 45 5.0° inclination		3/4	40°	B0819	
615			TE 45 7.0° inclination		3/4	40°	UC	
B45			TE 45 7.0° inclination		3/4	40°	B0819	
618		TE 45 10.0° inclination		3	40°	UC		
B46		TE 45 10.0° inclination		3	40°	B0819		
G10	PLUNGE-MILL ≤ 45 HRC		PLUNGE-MILL		4	45°	G6110	
G12			PLUNGE-MILL		4	45°	G6110	•
H15	THREAD MILL		Thread Mill M, With Internal Oil Hole		3/4/5	30°	G6110	
H17			Thread Mill MF, With Internal Oil Hole		3/4/5	30°	G6110	
H19			Thread Mill M, Without Internal Oil Hole		3/4/5	30°	G6110	
H21			Thread Mill MF, Without Internal Oil Hole		3/4/5	30°	G6110	
923	BN 30 ≤ 35 HRC		BN 30		2	30°	B0819	
925			BN 30 Long		2	30°	B0819	
927			BN 30 Extra-Long		2	30°	B0819	

Application				Working Material																Page / Seite / 页		
				P			M		K		N			S			H		O			
				P01	P02	P03	M01	M02	K01	K02	N01	N02	N03	S01	S02	S03	H01	H02	O01		O02	
				Carbon steel	Alloy steel	Prehardened steel, 35 ≤ HRC < 45	Stainless steel, high machinability	Stainless steel, low machinability	Grey cast iron	Ductile cast iron	Aluminum wrought alloy, Si < 9%	Aluminum cast alloy, Si ≥ 9%	Copper alloy	Titanium alloy	Nickel alloy	Cobalt alloy	Hardened steel, 45 ≤ HRC < 52	Hardened steel, ≥ 52 HRC	Thermoplastics	Graphite		
•						•				•							•					336
•						•				•							•					336
•						•				•							•					337
•						•				•							•					337
•						•				•							•					338
•						•				•							•					338
•						•				•							•					339
•						•				•							•					339
•						•				•							•					340
•						•				•							•					340
•						•				•							•					341
•						•				•							•					341
•						•				•							•					342
•						•				•							•					342
•						•				•							•					343
•						•				•							•					343
•						•				•							•					344
•						•				•							•					344
•						•				•							•					345
•						•				•							•					345
•			•	•	•					•												349
•			•	•	•					•												349
						•	•	•	•	•	•	•	•	•	•	•						354
						•	•	•	•	•	•	•	•	•	•	•						354
						•	•	•	•	•	•	•	•	•	•	•						353
						•	•	•	•	•	•	•	•	•	•	•						353
						•	•	○	•	○	•	○	○	•		○				○		360
						•	•	○	•	○	•	○	○	•		○				○		361
						•	•	○	•	○	•	○	○	•		○				○		362

Index by Series

EDP Number	Type Typ Type Tipo 系列			N° Z	Helix Angle	Coating	Recess
929			BN 45	2	30°	B0819	
C36			BN 45	2	30°	G6110	
F38			BN 45	2	30°	B0819	•
B82			BN 45	4	30°	B0819	
931			BN 45 Long	2	30°	B0819	
933			BN 45 Extra-Long	2	30°	B0819	
940			BN 45	2	30°	B0819	
941			BN 45	2	30°	B0819	•
A57			BN 45	2	30°	B0909	
A58			BN 45	2	30°	B0909	•
485			BN 45	4	30°	G6110	
942			BN 45 Long	2	30°	B0819	
943	BN 45 36 -50 HRC		BN 45 Long	2	30°	B0819	•
A59			BN 45 Long	2	30°	B0909	
A60			BN 45 Long	2	30°	B0909	•
944			BN 45 Extra-Long	2	30°	B0819	
945			BN 45 Extra-Long	2	30°	B0819	•
A61			BN 45 Extra-Long	2	30°	B0909	
A62			BN 45 Extra-Long	2	30°	B0909	•
935			BN 45 Mini	2	30°	B0819	
A63			BN 45 Mini	2	30°	B0909	
A65			BN 45 Miniature Long Neck	2	30°	B0909	
937			BN 45 Miniature Long Neck	2	30°	B0819	
A76			BN 45 Miniature Long Neck	2	30°	B0909	
A78			BN 45 Taper Neck	2	30°	B0909	

Application				Working Material																Page / Seite / 页	
				P			M		K		N			S			H		O		
				P01	P02	P03	M01	M02	K01	K02	N01	N02	N03	S01	S02	S03	H01	H02	O01		O02
				Carbon steel	Alloy steel	Prehardened steel, 35 ≤ HRC < 45	Stainless steel, high machinability	Stainless steel, low machinability	Grey cast iron	Ductile cast iron	Aluminum wrought alloy, Si < 9%	Aluminum cast alloy, Si ≥ 9%	Copper alloy	Titanium alloy	Nickel alloy	Cobalt alloy	Hardened steel, 45 ≤ HRC < 52	Hardened steel, ≥ 52 HRC	Thermoplastics	Graphite	
Roughing & Finishing				○	○	●	○	●	○	●					○	●	●	○			370
Roughing & Finishing				○	○	●	○	●	○	●					○	●	●	○			370
Roughing & Finishing				○	○	●	○	●	○	●					○	●	●	○			371
Roughing & Finishing				○	○	●	○	●	○	●					○	●	●	○			372
Roughing & Finishing				○	○	●	○	●	○	●					○	●	●	○			373
Roughing & Finishing				○	○	●	○	●	○	●					○	●	●	○			374
Roughing & Finishing				○	○	●	○	●	○	●					○	●	●	○			375
Roughing & Finishing				○	○	●	○	●	○	●					○	●	●	○			375
Roughing & Finishing				○	○	●	○	●	○	●					○	●	●	○			375
Roughing & Finishing				○	○	●	○	●	○	●					○	●	●	○			375
Roughing & Finishing				○	○	●	○	●	○	●					○	●	●	○			375
Roughing & Finishing				○	○	●	○	●	○	●					○	●	●	○			377
Roughing & Finishing				○	○	●	○	●	○	●					○	●	●	○			377
Roughing & Finishing				○	○	●	○	●	○	●					○	●	●	○			377
Roughing & Finishing				○	○	●	○	●	○	●					○	●	●	○			377
Roughing & Finishing				○	○	●	○	●	○	●					○	●	●	○			378
Roughing & Finishing				○	○	●	○	●	○	●					○	●	●	○			379
Roughing & Finishing				○	○	●	○	●	○	●					○	●	●	○			378
Roughing & Finishing				○	○	●	○	●	○	●					○	●	●	○			379
Roughing & Finishing				○	○	●	○	●	○	●					○	●	●	○			380
Roughing & Finishing				○	○	●	○	●	○	●					○	●	●	○			380
Profiling				○	○	●	○	●	○	●					○	●	●	○			381
Profiling				○	○	●	○	●	○	●					○	●	●	○			382
Profiling				○	○	●	○	●	○	●					○	●	●	○			382
Profiling				○	○	●	○	●	○	●					○	●	●	○			384

Index by Series

EDP Number	Type Typ Type Tipo 系列			N° Z	Helix Angle	Coating	Recess
A1L	BN 60 53 - 68 HRC		BN 60	4	30°	B0909	
A71			BN 60 Long	2	30°	B0909	
A72			BN 60 Long	2	30°	B0909	•
A73			BN 60 Extra-Long	2	30°	B0909	
A74			BN 60 Extra-Long	2	30°	B0909	•
A75			BN 60 Miniature	2	30°	B0909	
A77			BN 60 Taper Neck	2	30°	B0909	
A4Q	BN 60X 40 - 60 HRC		BN 60X	2	30°	B0909	
A4R			BN 60X	2	30°	B0909	•
A4S			BN 60X Miniature Long Neck	2	30°	B0909	
A5Q	DM70 (BN 70) 50 - 70 HRC		BN 70	2	30°	B0909+	
A5R			BN 70	2	30°	B0909+	•
A5S			BN 70 Miniature Long Neck	2	30°	B0909+	
754	BN GR Thermoplastic & Graphite		BN GR	2	30°	DCT01	
756			BN GR Long Neck	2	30°	DCT01	
B85			BN GR Extra-Long	2	30°	DCT01	
666	NC SPOT ≤ 35 HRC		DR NC 120°	2	30°	UC	
957			DR NC 120°	2	30°	B0819	
662			DR NC 60°	2	30°	UC	
953			DR NC 60°	2	30°	B0819	
664			DR NC 90°	2	30°	UC	
955			DR NC 90°	2	30°	B0819	
D09	DR ALU Non Ferrous Metal		DR ALU OF - 3 x Ø	2	30°	UC	
D10			DR ALU OF - 5 x Ø	2	30°	UC	
W16	EZ DRILL ≤ 35 HRC		EZ Drill - 3 x Ø	2	30°	T8090	
W17			EZ Drill - 5 x Ø	2	30°	T8090	
D07	DR NiTiCo ≤ 35 HRC		DR NiTiCo OF - 3 x Ø	2	30°	T8090	
D08			DR NiTiCo OF - 5 x Ø	2	30°	T8090	
C73	DR VA ≤ 45 HRC		DR VA OF - 3 x Ø	2	30°	T8090	
C77			DR VA OF - 5 x Ø	2	30°	T8090	

Application				Working Material																Page / Seite / 页	
				P			M		K		N			S			H		O		
				P01	P02	P03	M01	M02	K01	K02	N01	N02	N03	S01	S02	S03	H01	H02	O01		O02
				Carbon steel	Alloy steel	Prehardened steel, 35 ≤ HRC < 45	Stainless steel, high machinability	Stainless steel, low machinability	Grey cast iron	Ductile cast iron	Aluminum wrought alloy, Si < 9%	Aluminum cast alloy, Si ≥ 9%	Copper alloy	Titanium alloy	Nickel alloy	Cobalt alloy	Hardened steel, 45 ≤ HRC < 52	Hardened steel, ≥ 52 HRC	Thermoplastics	Graphite	
Roughing & Finishing																	○	○			400
Roughing & Finishing																	○	○			401
Roughing & Finishing																	○	○			401
Roughing & Finishing																	○	○			402
Roughing & Finishing																	○	○			402
Profiling																	○	○			403
Profiling																	○	○			404
Roughing & Finishing			●														●	●			413
Roughing & Finishing			●														●	●			413
Profiling			●														●	●			414
Roughing & Finishing																	●	●			424
Roughing & Finishing																	●	●			424
Profiling																	●	●			427
Roughing & Finishing																				●	437
Roughing & Finishing																				●	438
Roughing & Finishing																				●	439
Spotting	●	●	●	●	●	●	●	●	●	●	●	●	●	●	●	●			○	○	445
Spotting	●	●	●	●	●	●	●	●	●	●	●	●	●	●	●	●			○	○	445
Spotting	●	●	●	●	●	●	●	●	●	●	●	●	●	●	●	●			○	○	443
Spotting	●	●	●	●	●	●	●	●	●	●	●	●	●	●	●	●			○	○	443
Spotting	●	●	●	●	●	●	●	●	●	●	●	●	●	●	●	●			○	○	444
Spotting	●	●	●	●	●	●	●	●	●	●	●	●	●	●	●	●			○	○	444
Spotting								●	●	●									○		449
Drilling	○	○	○					○	○	●	●	●							○		450
Drilling	○	○	○					○	○	●	●	●							○		454
Drilling										●	●	●							○		456
Drilling				○	○								●		○						459
Drilling				○	○								●		○						460
Drilling			○	●	●								○	●							464
Drilling			○	●	●								○	●							465

EDP Number	Type Typ Type Tipo 系列			N° Z	Helix Angle	Coating	Recess
W08	DR-S ≤ 45 HRC		DR-S - 3 x Ø	2	30°	T8090	
W09			DR-S - 5 x Ø	2	30°	T8090	
W10			DR-S OF - 3 x Ø	2	30°	T8090	
W11			DR-S OF - 5 x Ø	2	30°	T8090	
H03	DR MINI ≤ 45 HRC		DR MINI OF - 5 x Ø, 8x Ø, 12 x Ø, 15x Ø, 20x Ø, 25x Ø, 30x Ø	2	30°	T8090	
W05	DR-LX ≤ 45 HRC		DR-LX OF - 12 x Ø, 15x Ø, 20x Ø, 25x Ø, 30x Ø	2	30°	T8090	
F33	DR 45 SB ≤ 45 HRC		DR 45 SB L OF - 8 x Ø	2	30°	T8090	
821	DR 60 ≤ 60 HRC		DR 60 - 5 x Ø	2	15°	D0120	
823			DR 60 - 3 x Ø	2	15°	D0120	
621	RE 45 ≤ 45 HRC		RE 45 SHORT	4/6	-	UC	
623			RE 45 L.H. / R.H. SHORT	4/6	12°	UC	
625			RE 45 R.H. DIN 212	4/6	-	UC	
627			RE 45 L.H. / R.H. DIN 212	4/6	12°	UC	
629			RE 45 HIGH L.H. / R.H. DIN 212	3/4/6	60°	UC	

Application				Working Material																Page / Seite / 页		
				P			M		K		N			S			H		O			
				P01	P02	P03	M01	M02	K01	K02	N01	N02	N03	S01	S02	S03	H01	H02	O01		O02	
				Carbon steel	Alloy steel	Prehardened steel, 35 ≤ HRC < 45	Stainless steel, high machinability	Stainless steel, low machinability	Grey cast iron	Ductile cast iron	Aluminum wrought alloy, Si < 9%	Aluminum cast alloy, Si ≥ 9%	Copper alloy	Titanium alloy	Nickel alloy	Cobalt alloy	Hardened steel, 45 ≤ HRC < 52	Hardened steel, ≥ 52 HRC	Thermoplastics	Graphite		
Drilling				•	•	•	○	○	•	•	○	○	○	•	•							469
Drilling				•	•	•	○	○	•	•	○	○	○	•	•							470
Drilling				•	•	•	○	○	•	•	○	○	○	•	•							471
Drilling				•	•	•	○	○	•	•	○	○	○	•	•							472
Drilling				•	•	•	•	•	•	•	•	•	•	•	•							479
Drilling				•	•	•	•	•	•	•	•	•	•	•	•							485
Drilling				•	•	•	○	○	•	•				•	•							493
Drilling																	•	•				497
Drilling																	•	•				498
Reaming				•	•	•	•	○	•	•	•	•	•	○	○							502
Reaming				•	•	•	•	○	•	•	•	•	•	○	○							503
Reaming				•	•	•	•	○	•	•	•	•	•	○	○							504
Reaming				•	•	•	•	○	•	•	•	•	•	○	○							505
Reaming				•	•	•	•	○	•	•	•	•	•	○	○							506



No	EDP	Series	Description	Page Number
1	303	ALU LINE	AL SE	51
2	K30	ALU LINE	AL SE DP	52
3	K31	ALU LINE	AL SE DP	52
4	S42	ALU LINE	AL SE DP	56
5	G52	ALU LINE	AL SE Torus,Edge Protection, Flute Polished	47
6	924	ALU LINE	AL SE, Flute Polished	44
7	K61	ALU LINE	XQ Alu DP/DH/DF Chip Breaker	61
8	867	SE 45	SE 45 Long	185
9	897	SE 45	SE 45 Long Reach - Long	205
10	885	SE 45	SE 45 Miniature Long Neck	190
11	A79	SE 45	SE 45R Torus Miniature Long Neck	193
12	904	SE 45	SE 45R Torus	207
13	A26	SE 45	SE 45R Torus	208
14	635	SE 45X	SE 45X DP	235
15	A06	SE 45X	SE 45X DP	235
16	A53	SE 60	SE 60R Long Reach - Extra-Long	262
17	A52	SE 60	SE 60R Long Reach - Long	261
18	A49	SE 60	SE 60R Recess	260
19	A4G	SE 60X	SE 60X Fin-Mill Torus Miniature Long Neck	274
20	G86	SE 60X	SE 60X Sweep-Mill	283
21	750	SE GR	SE GR	328
22	918	OPTIMUM	Optimum Line DP	165
23	K38	OPTIMUM	Optimum Line R-LIKE DP	166
24	J89	NiTiCo 30	NiTiCo 30 DH	122
25	J92	NiTiCo 30	NiTiCo 30 DH Long	123
26	K67	NiTiCo 30	NiTiCo 30 DH Long Internal Oil Hole, Weldon, Recess	127
27	K65	NiTiCo 30	NiTiCo 30 DH Standard Internal Oil Hole, Weldon, Recess	126
28	951	NiTiCo 30	NiTiCo 30 DP	119
29	C46	NiTiCo 30	NiTiCo 30 DP Torus	120
30	949	NiTiCo 30	NiTiCo 30 DP/DH	130
31	C48	NiTiCo 30	NiTiCo 30 DP/DH	132
32	C47	NiTiCo 30	NiTiCo 30 Roughing	136
33	C64	NiTiCo 30	NiTiCo 30 Roughing, Weldon	136
34	A59	BN 45	BN 45 Long	377
35	937	BN 45	BN 45 Miniature Long Neck	382
36	929	BN 45	BN 45	370
37	A57	BN 45	BN 45	375
38	A4S	BN 60X	BN 60X Miniature Long Neck	414
39	756	BN GR	BN GR Long Neck	438
40	F33	DR 45 SB	DR 45 SB OF - 8 x Ø	493
41	H03	DR MINI	DR MINI OF - 5 x Ø, 8x Ø, 12 x Ø, 15x Ø, 20x Ø, 25x Ø, 30x Ø	479
42	955	DR NC	DR NC 90°	444
43	C77	DR VA	DR VA OF - 5 x Ø	465
44	W05	DR-LX	DR-LX OF - 12 x Ø, 15x Ø, 20x Ø, 25x Ø, 30x Ø	485
45	W08	DR-S	DR-S - 3 x Ø	469
46	W10	DR-S	DR-S OF - 3 x Ø	471
47	W09	DR-S	DR-S - 5 x Ø	470
48	W11	DR-S	DR-S OF - 5 x Ø	472

Obsoleted Listing



EDP No	Coating	Description	Alternative
644	UC	DR 30 - 3 x Ø	W16
729	UC	DR 30 - 5 x Ø	W17
802	B0819	SE 30 Standard	C76
820	B0819	SE 30 Standard	C76
958	B0819	DR 30 ~ DIN 6539 - 3 x Ø	W16
960	B0819	DR 30 - 5 x Ø	W17
965	B0819	DR 45 - DIN 6537K - 3 x Ø	W16 / W08
967	B0819	DR 45 - DIN 6537L - 5 x Ø	W11
A35	B0909	SE 60 Standard	A5F
A42	B0909	SE 60 Multiflute	K77
A43	B0909	SE 60 Multiflute	K76
A50	B0909	SE 60 Standard	A5H
A56	B0909	SE 60 Miniature Long Neck	A5D / A5E
A66	B0909	BN 45 Miniature Long Neck	A76
A69	B0909	BN 60 Standard	A5Q
A70	B0909	BN 60 Standard	A5R
A80	B0909	SE 60 Miniature Long Neck	A5G
B47	B0819	DR 45 - DIN 6537L - 5 x Ø	W09
B48	B0819	DR 45 - DIN 6537K - 3 x Ø	W16 / W08
C32	G6110	NiTiCo 30	C76
G14	G6110	NiTiCo 45 DP	K92
G15	B0909	NiTiCo 45 DP	K92
G17	G6110	NiTiCo 45 DP	K93
G18	B0909	NiTiCo 45 DP	K93
G20	G6110	NiTiCo 45 DP Weldon	K94
G21	B0909	NiTiCo 45 DP Weldon	K94
G23	G6110	NiTiCo 45 DP Weldon	K95
G24	B0909	NiTiCo 45 DP Weldon	K95
G26	G6110	NiTiCo 45 DP Torus	K96
G27	B0909	NiTiCo 45 DP Torus	K96
G29	G6110	NiTiCo 45 DP Torus	K97
G30	B0909	NiTiCo 45 DP Torus	K97
G32	G6110	NiTiCo 45 DP Torus Weldon	K98
G33	B0909	NiTiCo 45 DP Torus Weldon	K98
G35	G6110	NiTiCo 45 DP Torus Weldon	K99
G36	B0909	NiTiCo 45 DP Torus Weldon	K99
G39	G6110	NiTiCo 45 DP Roughing	G38
G42	G6110	NiTiCo 45 DP Roughing, Recess	G41
G45	G6110	NiTiCo 45 DP Roughing, Weldon	G44
G48	G6110	NiTiCo 45 DP Roughing, Weldon, Recess	G47
F32	D0120	DR 45 SB L OF - 8 x Ø	F33

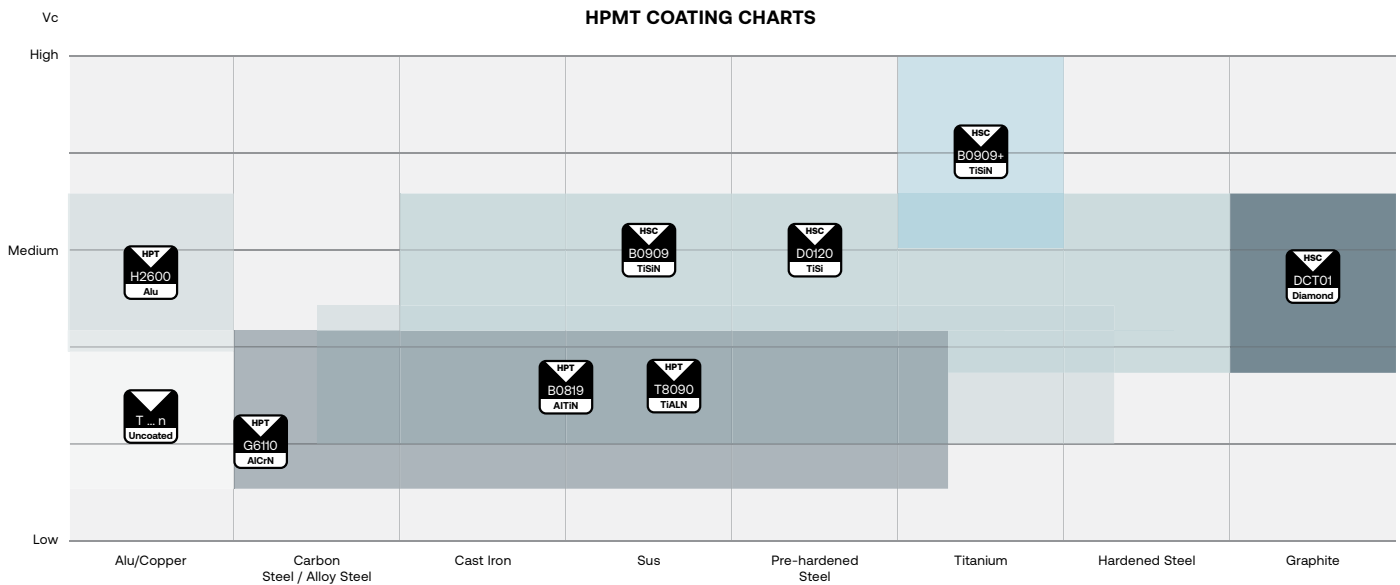

Coatings

Type of Coating	Coating Material	Hardness	Application Area	Coating Colour
	Uncoated	-/-	-/-	-/-
	AlTiN (Monolayer)	(HV 0.05) 3,300	Suitable for medium and high speed, wet and dry machining and good for machining steel with hardness up to HRC 52.	 Blue-Black
	TiSi Based (Multilayer)	(HV 0.05) 3,600	Suitable for high speed (wet/dry) and hard machining for difficult materials above HRC 52. Suitable for high speed machining with hardened steels above HRC 60	 Copper
	AlTiSiN Based (Multilayer)	3,800	Suitable for high speed (dry) and hard machining for difficult material above HRC 50. Suitable for high speed machining with hardened steels above HRC60. Vc & Vf = +30%	 Copper to Brown
	AlCrN (Monolayer)	(HV 0.05) 3,200	Suitable for low to medium speed, wet and dry machining and good for machining steel with hardness and high temperature alloy up to HRC 52.	 Blue-Grey
	Diamond (Monolayer)	(GPA) 40-90	Suitable for machining graphite and composite reinforced plastic fiber glass (CRP) (e.g. graphite electrodes, crucibles, boats)	 Dark Grey
	Alu	2,600	Suitable for aluminium.	 Barley
	TiSi Based (Multilayer)	(HV 0.05) 3,600	Suitable for high performance drilling in difficult machining material.	 Copper
	TiAlN (Multilayer)	(HV 0.05) 3,300	Suitable for low and medium cutting speed under wet machining.	 Blue-Black

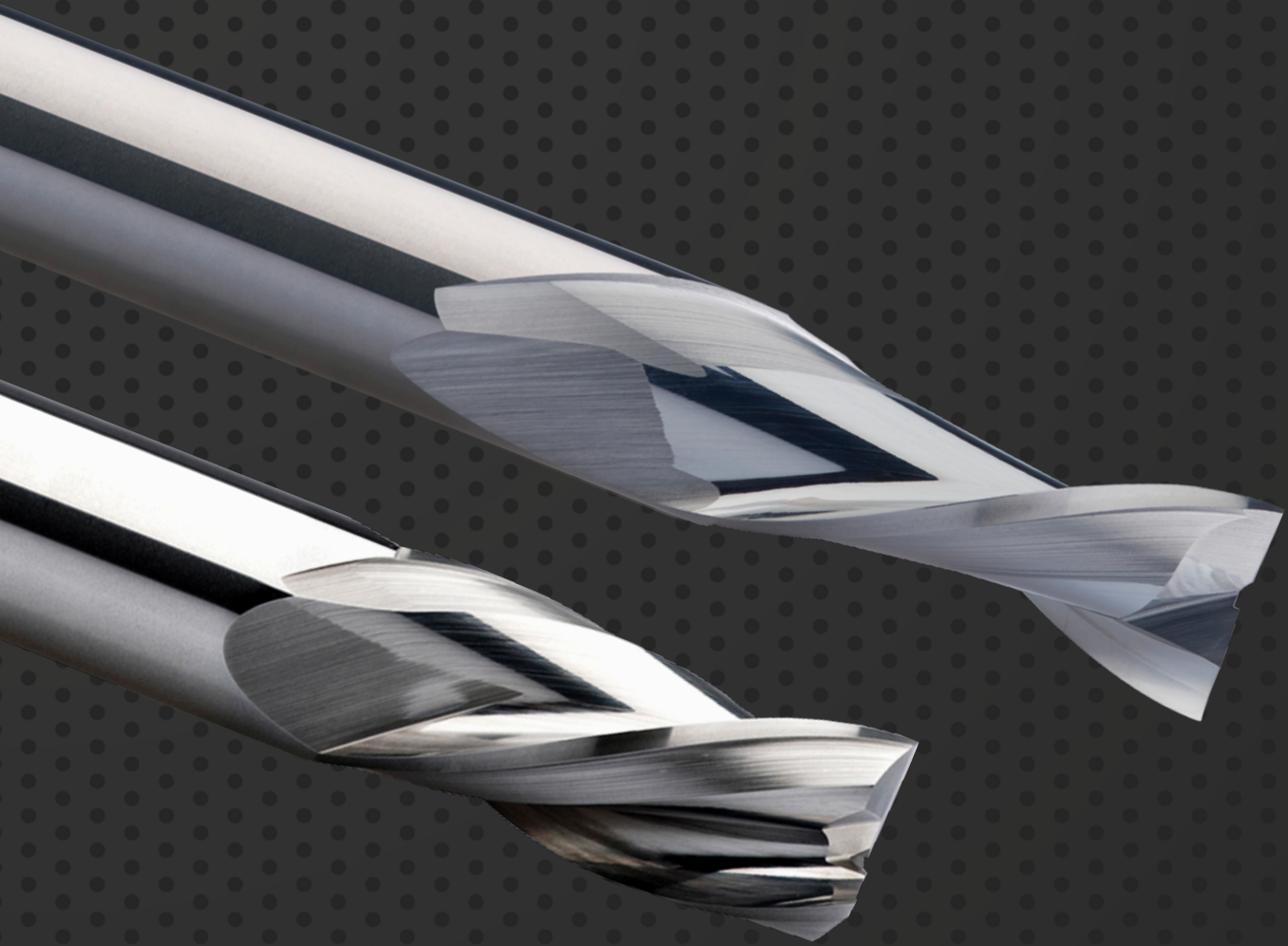

ENDMILLS

ALU LINE

Wide range of carbide endmills





Index - Alu Line, For Non Ferrous Metal

Suitable for Material Groups
 Adapté pour les matériaux
 适用于材料
 Geeignet für die Materialgruppen
 Adatto per il materiale

N **O**

EDP Number	Type	No. Z	Helix Angle	Coating	Performance	Page Number
788	AL SE	1	25°	UC	G	44
924	AL SE, Flute Polished	1	25°	UC	G	44
G49	AL SE	2	40°	UC	G	45
301	AL SE	2	50°	UC	P	46
G52	AL SE Torus, Edge Protection, Flute Polished	2	30°	UC	P	47
G53	AL SE Torus, Edge Protection, Flute Polished, Recess	2	30°	UC	P	47
G56	AL SE Long Torus, Edge Protection, Flute Polished	2	30°	UC	P	48
G57	AL SE Long Torus, Edge Protection, Flute Polished, Recess	2	30°	UC	P	48
G71	AL SE Reduced Shank	2	30°	UC	P	49
G50	AL SE	3	40°	UC	G	50
303	AL SE DP	3	50°	UC	G	51
K30	AL SE DP	3	40°	UC	G	52
K31	AL SE Long	3	40°	H2600	G	52
G51	AL SE	3	40°	UC	P	53
G69	AL SE DP, Edge Protection, Flute Polished	3	30°	UC	P	54
G70	AL SE DP, Edge Protection	3	30°	UC	P	54
G72	AL SE DP Torus Roughing	3	40°	UC	P	55
G73	AL SE DP Torus Roughing, Recess	3	40°	UC	P	55
S42	AL SE DP	4	40°	UC	P	56
C45	AL SE DP Torus	4	40°	UC	P	57
C51	AL SE DP Torus, Weldon	4	40°	UC	P	57
NEW K60	XQ Alu DP/DH/DF, Recess	4	a° ≠ b°	UC	P	60
NEW K61	XQ Alu DP/DH/DF, Recess, Chip Breaker	4	a° ≠ b°	UC	P	61
NEW K62	XQ Alu Torus DP/DH/DF, Recess	4	a° ≠ b°	UC	P	64
NEW K63	XQ Alu Torus DP/DH/DF, Recess, Chip Breaker	4	a° ≠ b°	UC	P	65
NEW K88	XQ Alu Long DP/DH/DF	4	a° ≠ b°	UC	P	66
NEW K89	XQ Alu Long DP/DH/DF, Chip Breaker	4	a° ≠ b°	UC	P	67
G68	AL SE Miniature Long Neck	2	40°	UC	G	68
G74	AL BN	2	30°	UC	G	70
G75	AL BN, Recess	2	30°	UC	G	70
G76	AL BN Miniature Long Neck	2	30°	UC	G	71

AL SE SINGLE FLUTE ENDMILLS

-  VHM AL SE Einzahn Fräser
-  Frese AL SE, 1 tagliente
-  Fraises AL SE à une dent
-  整体硬质合金 AL SE 系列 单刃平底铣刀

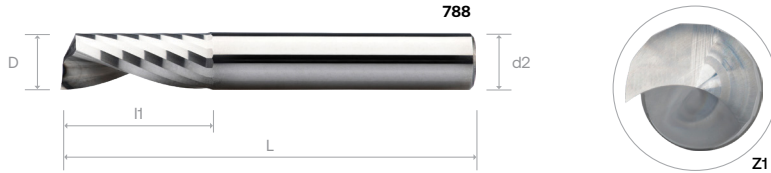

Order Number	Dimension (mm)					Normal		Order Number	Dimension (mm)					Flute Polished	
	D	I1	I2	L	d2 (h6)	UC	D		I1	I2	L	d2 (h6)	UC		
788 0200 *	2	10		40	2	•	924 0200 *	2	10		40	2	•		
788 0300 *	3	12		40	3	•	924 0300 *	3	12		40	3	•		
788 0400	4	15		50	4	•	924 0400	4	15		50	4	•		
788 0500	5	16		50	5	•	924 0500	5	16		50	5	•		
788 0600	6	20		60	6	•	924 0600	6	20		60	6	•		
788 0800	8	22		63	8	•	924 0800	8	22		63	8	•		
788 1000	10	25		72	10	•	924 1000	10	25		72	10	•		
788 1200	12	30		83	12	•	924 1200	12	30		83	12	•		

* - DIN 6535

ALU LINE
 EZ LINE - ENDMILL
 SE 30
 NITICO 30
 OPTIMUM
 SE 45
 SE 45X
 NITICO 45
 SE 60
 SE 60X
 DN70 - SE 70
 SE GR
 TE 45
 PLUNGE -MILL
 THREAD MILL

Material Group | Material-Gruppe | Groupe Matière | Gruppo Materiali | 材质主类

Cutting Parameter

N01	N02	N03	K01	K02	P01	P02	P03	M01	M02	S01	S02	S03	H01	H02	O01	O02	72
-----	-----	-----	-----	-----	-----	-----	-----	-----	-----	-----	-----	-----	-----	-----	-----	-----	----

AL SE ENDMILLS, 2 FLUTES

- VHM AL SE Fräser, 2 Zähne
- Frese AL SE, 2 taglienti
- Fraises AL SE - 2 dents
- 整体硬质合金 AL SE 系列 2刃平底铣刀

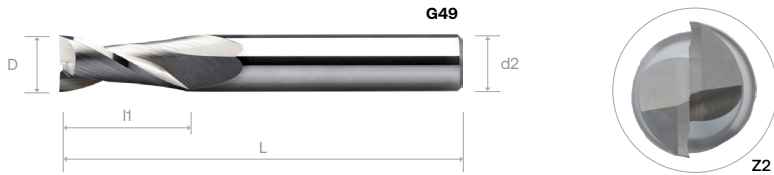

Order Number	Dimension (mm)					UC
	D	L1	L2	L	d2 (h6)	
G49 0100 040 04	1	3		40	4	•
G49 0150 040 04 *	1.5	4.5		40	4	◦
G49 0200 040 04	2	6.5		40	4	◦
G49 0250 040 04 *	2.5	6.5		40	4	◦
G49 0300	3	9		40	3	•
G49 0300 050 06				50	6	•
G49 0400	4	12		50	4	•
G49 0400 050 06				50	6	•
G49 0500 050 06				50	6	◦
G49 0600 050	6	16		50	6	•
G49 0600 060		20		60	6	•
G49 0800	8	20		64	8	◦
G49 1000 070	10		22		70	10
G49 1000 075		31		75	10	◦
G49 1200	12	25		75	12	•
G49 1400	14	32		90	14	◦
G49 1600				90	16	◦
G49 2000	20	38		100	20	◦

* - DIN 6535

Ø mm	Tol. µm
01 - 2.9	-0 / -20
3.0 - 6.0	-0 / -25
6.0 - 30.0	-0 / -30

Material Group | Material-Gruppe | Groupe Matière | Gruppo Materiali | 材质主类

Cutting Parameter

N01	N02	N03	K01	K02	P01	P02	P03	M01	M02	S01	S02	S03	H01	H02	O01	O02	72 - 73
-----	-----	-----	-----	-----	-----	-----	-----	-----	-----	-----	-----	-----	-----	-----	-----	-----	---------

AL SE ENDMILLS, 2 FLUTES

- VHM AL SE Fräser, 2 Zähne
- Frese AL SE, 2 taglienti
- Fraises AL SE - 2 dents
- 整体硬质合金 AL SE 系列 2刃平底铣刀

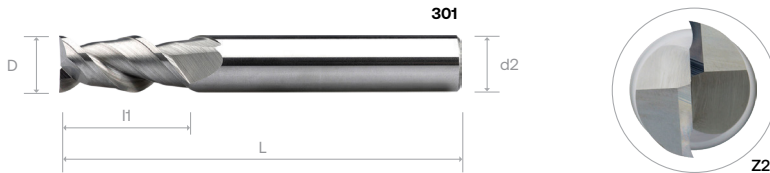

Order Number	Dimension (mm)					UC
	D	I1	I2	L	d2 (h6)	
301 0100 040 03	1	3		40	3	•
301 0100 040 04				40	4	•
301 0150 040 03	1.5	4.5		40	3	•
301 0150 040 04 *				40	4	•
301 0200 040 03	2	6.5		40	3	•
301 0200 040 04 *				40	4	•
301 0250 040 03				40	3	•
301 0250 040 04	2.5			40	4	◦
301 0300	3	9		40	3	•
301 0300 050 06				50	6	•
301 0400	4	12		50	4	•
301 0400 050 06				50	6	•
301 0500	5	15		50	5	•
301 0500 050 06				50	6	•
301 0600 050	6	16		50	6	•
301 0600 060			60	6	•	
301 0800	8	20		64	8	•
301 1000 070	10	22		70	10	•
301 1000 075				75	10	•
301 1200	12	25		75	12	◦
301 1400	14	32		90	14	•
301 1600	16			90	16	•
301 1800	18	38		100	18	•
301 2000	20			100	20	◦

* - DIN 6535

CNC Repeatability
 Ø1 - Ø3 within 10µm
 Ø4 - Ø8 within 15µm
 ≥ Ø10 within 20µm

Material Group | Material-Gruppe | Groupe Matière | Gruppo Materiali | 材质主类



Cutting Parameter

73

ALU LINE
 EZ LINE - ENDMILL
 SE 30
 NITICO 30
 OPTIMUM
 SE 45
 SE 45X
 NITICO 45
 SE 60
 SE 60X
 DN70 - SE 70
 SE GR
 TE 45
 PLUNGE -MILL
 THREAD MILL

AL SE ENDMILLS, EDGE PROTECTION, FLUTE POLISHED, 2 FLUTES

- VHM AL SE Torusfräser, 2 Zähne
- Frese toroidali AL SE, 2 taglienti
- Fraises AL SE toriques - 2 dents
- 整体硬质合金 AL SE 系列 2刃刀尖保护铣刀

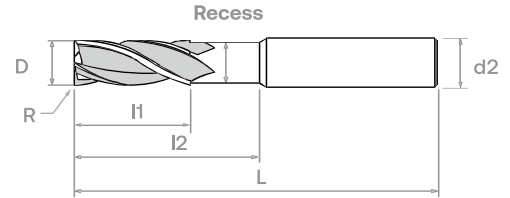
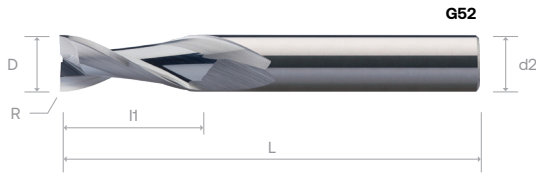

Order Number	Dimension (mm)								Normal	Order Number	Dimension (mm)								Flute Polished
	D	l1	l2	d3	L	d2 (h6)	R	UC			D	l1	l2	d3	L	d2 (h6)	R	UC	
G52 0200	2	6.5		2.8	40	4	0.1	•	G53 0200	2	6.5		2.8	40	4	0.1			
G52 0200 050 06				2.8	50	6	0.1	•	G53 0200 050 06				2.8	50	6	0.1			
G52 0300	3	9		2.8	40	3	0.1	•	G53 0300	3	9	15	2.8	40	3	0.1	•		
G52 0300 050 06				2.8	50	6	0.1	•	G53 0300 050 06				2.8	50	6	0.1	•		
G52 0400	4	12		3.7	50	4	0.1	•	G53 0400	4	12	20	3.7	50	4	0.1	•		
G52 0400 050 06 06		6		3.7	50	6	0.1	•	G53 0400 050 06 06		6	12	3.7	50	6	0.1	•		
G52 0400 050 06		12		3.7	50	6	0.1	•	G53 0400 050 06		12	20	3.7	50	6	0.1	•		
G52 0500 050 06	5	15		4.6	50	6	0.1	•	G53 0500 050 06	5	15	20	4.6	50	6	0.1	•		
G52 0600 060 09	6	9		5.5	60	6	0.1	•	G53 0600 060 09	6	9	18	5.5	60	6	0.1	◦		
G52 0600 060		20	5.5	60	6	0.1	•	G53 0600 060	20		30	5.5	60	6	0.1	•			
G52 0800 12	8	12		7.4	64	8	0.1	•	G53 0800 12	8	12	24	7.4	64	8	0.1	•		
G52 0800		20		7.4	64	8	0.1	•	G53 0800		20	30	7.4	64	8	0.1	◦		
G52 1000 15	10	15		9.2	75	10	0.1	•	G53 1000 15	10	15	32	9.2	75	10	0.1	•		
G52 1000		22		9.2	75	10	0.1	•	G53 1000		22	32	9.2	75	10	0.1	◦		
G52 1200 18	12	18		11	75	12	0.1	•	G53 1200 18	12	18	37	11	75	12	0.1	•		
G52 1200		25		11	75	12	0.1	•	G53 1200		25	37	11	75	12	0.1	•		
G52 1400	14	32		13	90	14	0.1	•	G53 1400	14	32	44	13	90	14	0.1	◦		
G52 1600 24	16	24		15	90	16	0.1	•	G53 1600 24		16	24	40	15	90	16	0.1	•	
G52 1600		32	15	90	16	0.1	•	G53 1600	32	46		15	90	16	0.1	•			
G52 2000	20	38		19	100	20	0.1	•	G53 2000	20	38	60	19	100	20	0.1	◦		

* - DIN 6535

CNC Repeatability

- Ø1 - Ø3 within 10µm
- Ø4 - Ø8 within 15µm
- ≥ Ø10 within 20µm

Material Group | Material-Gruppe | Groupe Matière | Gruppo Materiali | 材质主类

Cutting Parameter

N01	N02	N03	K01	K02	P01	P02	P03	M01	M02	S01	S02	S03	H01	H02	O01	O02	72 - 73
-----	-----	-----	-----	-----	-----	-----	-----	-----	-----	-----	-----	-----	-----	-----	-----	-----	---------

AL SE LONG TORUS ENDMILLS, EDGE PROTECTION, FLUTE POLISHED, 2 FLUTES

- VHM AL SE Torusfräser, 2 Zähne
- Frese toroidali lunghe AL SE, 2 taglienti
- Fraises AL SE toriques longues - 2 dents
- 整体硬质合金 AL SE 系列 2刃长型刀尖保护铣刀

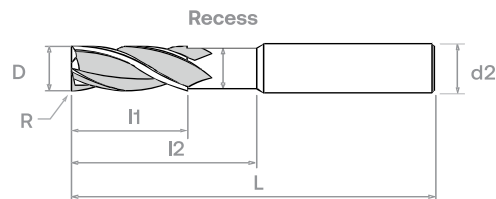
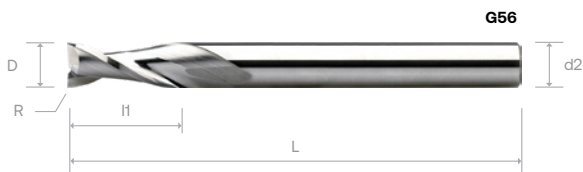

Order Number	Dimension (mm)								Normal
	D	l1	l2	d3	L	d2 (h6)	R	UC	
G56 0600	6	16		5.5	80	6	0.1	•	
G56 0800	8	20		7.4	80	8	0.1	•	
G56 1000	10	22		9.2	100	10	0.1	•	
G56 1200	12	25		11	100	12	0.1	◦	
G56 1400	14	32		13	125	14	0.1	•	
G56 1600	16		15	125	16	0.1	◦		
G56 2000	20	38		19	125	20	0.1	◦	

Order Number	Dimension (mm)								Flute Polished
	D	l1	l2	d3	L	d2 (h6)	R	UC	
G57 0600	6	16	40	5.5	80	6	0.1	•	
G57 0800	8	20	40	7.4	80	8	0.1	•	
G57 1000	10	22	60	9.2	100	10	0.1	•	
G57 1200	12	25	60	11	100	12	0.1	◦	
G57 1400	14	32	75	13	125	14	0.1	◦	
G57 1600	16		75	15	125	16	0.1	•	
G57 2000	20	38	75	19	125	20	0.1	•	

Material Group | Material-Gruppe | Groupe Matière | Gruppo Materiali | 材质主类



CNC Repeatability

Ø1 - Ø3 within 10µm
 Ø4 - Ø8 within 15µm
 ≥ Ø10 within 20µm

Cutting Parameter

73

AL SE REDUCED SHANK ENDMILLS, 2 FLUTES

- VHM AL SE Fräser, 2 Zähne
- Frese AL SE, con gambo ridotto, 2 taglienti
- Fraises AL SE - 2 dents
- 整体硬质合金 AL SE 系列 2 刃刀尖保护铣刀

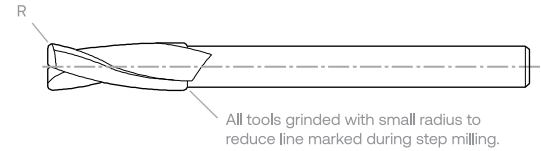
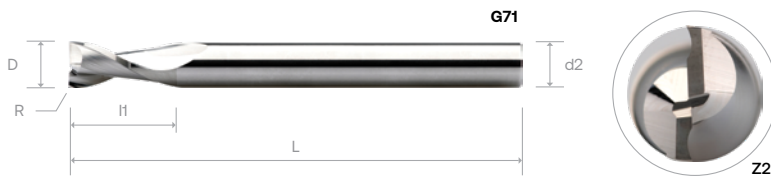

Order Number	Dimension (mm)						UC
	D	I1	I2	L	d2 (h6)	R	
G71 0320 075	3.2	4		75	3	0.1	•
G71 0420 075	4.2	5		75	4	0.1	•
G71 0520 075	5.2	6		75	5	0.1	•
G71 0620 075	6.2	8		75	6	0.1	•
G71 0620 100	6.2	8		100	6	0.1	•
G71 0820 075	8.2	10		75	8	0.1	◦
G71 0820 100	8.2	10		100	8	0.1	◦
G71 1030 100	10.3	14		100	10	0.1	•
G71 1030 125	10.3	14		125	10	0.1	•
G71 1230 100	12.3	16		100	12	0.1	◦
G71 1230 125	12.3	16		125	12	0.1	•
G71 1630 125	16.3	20		125	16	0.1	•
G71 2030 125	20.3	25		125	20	0.1	◦

CNC Repeatability	
Ø1 - Ø3	within 10µm
Ø4 - Ø8	within 15µm
≥ Ø10	within 20µm

Material Group | Material-Gruppe | Groupe Matière | Gruppo Materiali | 材质主类

Cutting Parameter

N01	N02	N03	K01	K02	P01	P02	P03	M01	M02	S01	S02	S03	H01	H02	O01	O02	72 - 73
-----	-----	-----	-----	-----	-----	-----	-----	-----	-----	-----	-----	-----	-----	-----	-----	-----	---------

AL SE ENDMILLS, 3 FLUTES

- VHM AL SE Fräser, 3 Zähne
- Frese AL SE, 3 taglienti
- Fraises AL SE - 3 dents
- 整体硬质合金 AL SE 系列 3刃平底铣刀

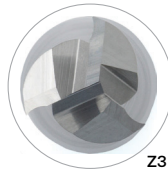
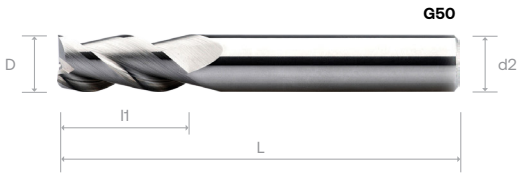

Order Number	Dimension (mm)					UC
	D	I1	I2	L	d2 (h6)	
G50 0100 040 04	1	3		40	4	◦
G50 0150 040 04 *	1.5	4.5		40	4	◦
G50 0200 040 04	2	6.5		40	4	•
G50 0250 040 04 *	2.5			40	4	•
G50 0300	3	9		40	3	•
G50 0300 050 06				50	6	•
G50 0400	4	12		50	4	•
G50 0400 050 06				50	6	•
G50 0500 050 06	5	15		50	6	•
G50 0600 050	6	16		50	6	•
G50 0600 060				60	6	•
G50 0800	8	20		64	8	•
G50 1000 070	10	22		70	10	•
G50 1000 075				75	10	•
G50 1200	12	25		75	12	◦
G50 1400	14	32		90	14	◦
G50 1600	16			90	16	◦
G50 2000	20	38		100	20	•

* - DIN 6535

Ø mm	Tol. µm
0.1 ~ 2.9	-0 / -20
3.0 ~ 6.0	-0 / -25
6.0 ~ 30.0	-0 / -30

Material Group | Material-Gruppe | Groupe Matière | Gruppo Materiali | 材质主类



Cutting Parameter

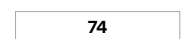

AL SE ENDMILLS, 3 FLUTES

- VHM AL SE Fräser, 3 Zähne
- Frese AL SE, 3 taglienti
- Fraises AL SE - 3 dents
- 整体硬质合金 AL SE 系列 3刃平底铣刀

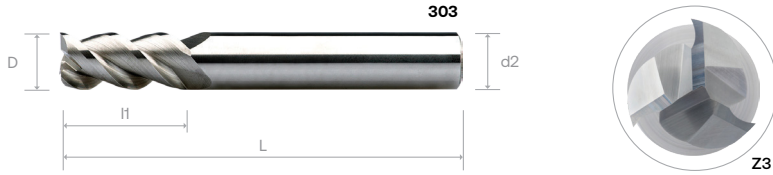

Order Number	Dimension (mm)					UC
	D	l1	l2	L	d2 (h6)	
303 0100 040 03	1	3		40	3	•
303 0100 040 04				40	4	•
303 0150 040 03	15	4.5		40	3	•
303 0150 040 04 *				40	4	•
303 0200 040 03 *	2	6.5		40	3	•
303 0200 040 04 *				40	4	•
303 0250 040 03	2.5			40	3	•
303 0250 040 04				40	4	•
303 0300	3	9		40	3	•
303 0300 050 06				50	6	•
303 0400	4	12		50	4	•
303 0400 050 06				50	6	•
303 0500	5	15		50	5	•
303 0500 050 06				50	6	•
303 0600 050	6	16		50	6	•
303 0600 060				60	6	•
303 0800	8	20		64	8	•
303 1000 070	10	22		70	10	•
303 1000 075				75	10	•
303 1200	12	25		75	12	•
303 1400	14	32		90	14	•
303 1600	16			90	16	•
303 1800	18	38		100	18	•
303 2000	20			100	20	•

* - DIN 6535

CNC Repeatability
Ø1 - Ø3 within 10µm
Ø4 - Ø8 within 15µm
≥ Ø10 within 20µm

Material Group | Material-Gruppe | Groupe Matière | Gruppo Materiali | 材质主类

Cutting Parameter

N01	N02	N03	K01	K02	P01	P02	P03	M01	M02	S01	S02	S03	H01	H02	O01	O02	74
-----	-----	-----	-----	-----	-----	-----	-----	-----	-----	-----	-----	-----	-----	-----	-----	-----	----

AL SE DP ENDMILLS, 3 FLUTES

- VHM AL SE DP Fräser, 3 Zähne
- Frese AL SE DP in metallo duro integrale, 3 taglienti
- Fraises AL SE DP - 3 dents
- 整体硬质合金 AL SE DP 系列 3刃平底铣刀

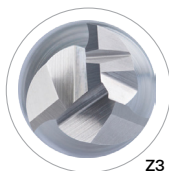
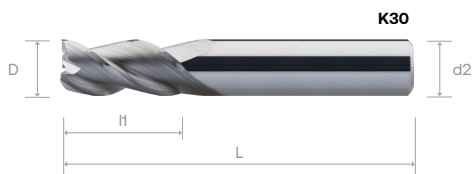
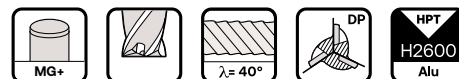

Order Number	Dimension (mm)					UC	Order Number	Dimension (mm)					H2600
	D	I1	I2	L	d2 (h6)			D	I1	I2	L	d2 (h6)	
K30 0100 040 04	1	3		40	4	•	K31 0100 040 04	1	3		40	4	•
K30 0150 040 04 *	1.5	4.5		40	4	•	K31 0150 040 04 *	1.5	4.5		40	4	•
K30 0200 040 04	2	6.5		40	4	•	K31 0200 040 04	2	6.5		40	4	•
K30 0250 040 04 *	2.5			40	4	•	K31 0250 040 04 *	2.5			40	4	•
K30 0300	3	9		40	3	•	K31 0300	3	9		40	3	•
K30 0300 050 06				50	6	•	K31 0300 050 06				50	6	•
K30 0400	4	12		50	4	•	K31 0400	4	12		50	4	•
K30 0400 050 06				50	6	•	K31 0400 050 06				50	6	•
K30 0500 050 06	5	15		50	6	•	K31 0500 050 06	5	15		50	6	•
K30 0600 050	6	16		50	6	•	K31 0600 050	6	16		50	6	•
K30 0600 060				60	6	•	K31 0600 060				60	6	•
K30 0800	8	20		64	8	•	K31 0800	8	20		64	8	•
K30 1000 070	10	22		70	10	•	K31 1000 070	10	22		70	10	•
K30 1000 075			31		75	10	•		K31 1000 075		31		75
K30 1200	12	25		75	12	•	K31 1200	12	25		75	12	•
K30 1600	16	32		90	16	•	K31 1600	16	32		90	16	•

* - DIN 6535

ALU LINE
EZ LINE - ENDMILL
SE 30
NITICO 30
OPTIMUM
SE 45
SE 45X
NITICO 45
SE 60
SE 60X
DN70 - SE 70
SE GR
TE 45
PLUNGE -MILL
THREAD MILL

Ø mm	Tol. µm
0.1 ~ 2.9	-0 / -20
3.0 ~ 6.0	-0 / -25
6.0 ~ 30.0	-0 / -30

Material Group | Material-Gruppe | Groupe Matière | Gruppo Materiali | 材质主类

N01
N02
N03
K01
K02
P01
P02
P03
M01
M02
S01
S02
S03
H01
H02
O01
O02

Cutting Parameter

74

AL SE LONG ENDMILLS, 3 FLUTES

- VHM AL SE Fräser, lang, 3 Zähne
- Frese lunghe AL SE, 3 taglienti
- Fraises AL SE longues - 3 dents
- 整体硬质合金 AL SE 系列 3刃长型平底铣刀



Order Number	Dimension (mm)					UC
	D	I1	I2	L	d2 (h6)	
G51 0300	3	19		60	3	•
G51 0300 075 06				75	6	•
G51 0400	4			60	4	•
G51 0400 075 06				75	6	•
G51 0500	5			75	6	•
G51 0600 075	6			31	75	6
G51 0600 100		38	100	6	•	
G51 0800 075	8	31	75	8	•	
G51 0800 100		41	100	8	•	
G51 1000 100	10	50	100	10	•	
G51 1000 125		57	125	10	•	
G51 1200 100	12	50	100	12	•	
G51 1200 150		75	150	12	•	
G51 1400	14	57		125	14	•
G51 1600	16			125	16	•

Ø mm	Tol. µm
0.1 - 2.9	-0 / -20
3.0 - 6.0	-0 / -25
6.0 - 30.0	-0 / -30

Material Group | Material-Gruppe | Groupe Matière | Gruppo Materiali | 材质主类

Cutting Parameter

N01	N02	N03	K01	K02	P01	P02	P03	M01	M02	S01	S02	S03	H01	H02	O01	O02	75
-----	-----	-----	-----	-----	-----	-----	-----	-----	-----	-----	-----	-----	-----	-----	-----	-----	----

AL SE DP ENDMILLS, EDGE PROTECTION, 2 FLUTES

- VHM AL SE Standard Torusfräser, 3 Zähne
- Frese toroidali AL SE, con passo differenziale, 2 taglienti
- Fraises AL SE DP - 2 dents
- 整体硬质合金 AL SE DP 系列 3刃刀尖保护铣刀



Order Number	Dimension (mm)							Flute Polished	UC	Order Number	Dimension (mm)							Normal
	D	I1	I2	L	d2 (h6)	R	UC				D	I1	I2	L	d2 (h6)	R	UC	
G69 0200	2	6.5		40	4	0.1	°		G70 0200	2	6.5		40	4	0.1	°		
G69 0200 050 06				50	6	0.1	°		G70 0200 050 06				50	6	0.1	•		
G69 0300	3	9		40	3	0.1	°		G70 0300	3	9		40	3	0.1	•		
G69 0300 050 06				50	6	0.1	•		G70 0300 050 06				50	6	0.1	•		
G69 0400	4	12		50	4	0.1	°		G70 0400	4	12		50	4	0.1	°		
G69 0400 050 06				50	6	0.1	•		G70 0400 050 06				50	6	0.1	•		
G69 0500 050 06	5	15		50	6	0.1	°		G70 0500 050 06	5	15		50	6	0.1	°		
G69 0600 060	6	20		60	6	0.1	°		G70 0600 060	6	20		60	6	0.1	•		
G69 0800	8			64	8	0.1	°		G70 0800	8				64	8	0.1	•	
G69 1000	10	22		75	10	0.1	•		G70 1000	10	22		75	10	0.1	•		
G69 1200	12	25		75	12	0.1	•		G70 1200	12	25		75	12	0.1	•		
G69 1400	14	32		90	14	0.1	•		G70 1400	14	32		90	14	0.1	•		
G69 1600	16			90	16	0.1	•		G70 1600	16				90	16	0.1	°	

ALU LINE
 EZ LINE - ENDMILL
 SE 30
 NITICO 30
 OPTIMUM
 SE 45
 SE 45X
 NITICO 45
 SE 60
 SE 60X
 DN70 - SE 70
 SE GR
 TE 45
 PLUNGE -MILL
 THREAD MILL

CNC Repeatability
 Ø1 - Ø3 within 10µm
 Ø4 - Ø8 within 15µm
 ≥ Ø10 within 20µm

Material Group | Material-Gruppe | Groupe Matière | Gruppo Materiali | 材质主类

N01	N02	N03	K01	K02	P01	P02	P03	M01	M02	S01	S02	S03	H01	H02	O01	O02
-----	-----	-----	-----	-----	-----	-----	-----	-----	-----	-----	-----	-----	-----	-----	-----	-----

Cutting Parameter

74

AL SE DP TORUS ROUGHING ENDMILLS, 3 FLUTES

- VHM AL SE DP Torus Schruppfräser, 3 Zähne
- Frese toroidali per sgrossare AL SE, con passo differenziale, 3 taglienti
- Fraises ébauches AL SE DP toriques 3 dents
- 整体硬质合金 AL SE DP 系列 3刃粗加工圆鼻铣刀

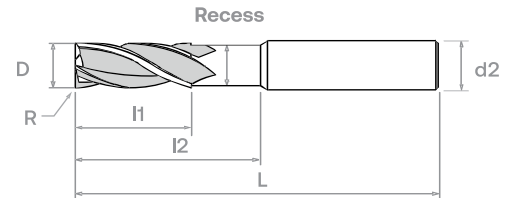
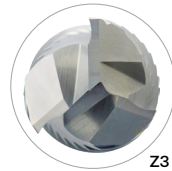
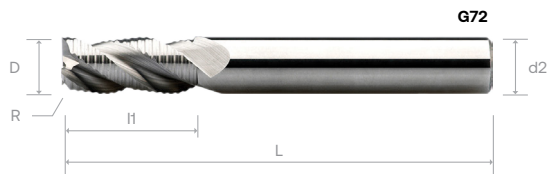

Order Number	Dimension (mm)								UC	Order Number <small>DIN 6535</small>	Dimension (mm)								UC
	D	I1	I2	d3	L	d2 (h6)	R	D			I1	I2	d3	L	d2 (h6)	R			
G72 0600	6	13		5.5	60	6	0.1	•	G73 0600 *	6	13	24	5.5	60	6	0.1	•		
G72 0600 075				5.5	75	6	0.1	◦	G73 0600 075				40	5.5	75	6	0.1	•	
G72 0800	8	20		7.4	64	8	0.1	◦	G73 0800 *	8	20	28	7.4	64	8	0.1	•		
G72 0800 075				7.4	75	8	0.1	•	G73 0800 075				40	7.4	75	8	0.1	•	
G72 1000 075	10	22		9.2	75	10	0.1	•	G73 1000 075	10	22	35	9.2	75	10	0.1	•		
G72 1000 100				9.2	100	10	0.1	•	G73 1000 100				60	9.2	100	10	0.1	•	
G72 1200 075	12	26		11	75	12	0.12	•	G73 1200 075	12	26	40	11	75	12	0.12	•		
G72 1200 100				11	100	12	0.12	•	G73 1200 100				60	11	100	12	0.12	◦	
G72 1600 090	16	32		15	90	16	0.16	•	G73 1600 090 *	16	32	40	15	90	16	0.16	•		
G72 1600 125				15	125	16	0.16	◦	G73 1600 125 *				75	15	125	16	0.16	◦	
G72 2000 100	20	40		19	100	20	0.2	◦	G73 2000 100 *	20	40	50	19	100	20	0.2	◦		
G72 2000 150				19	150	20	0.2	◦	G73 2000 150 *				100	19	150	20	0.2	◦	

* - DIN 6535

Material Group | Material-Gruppe | Groupe Matière | Gruppo Materiali | 材质主类

Cutting Parameter

N01	N02	N03	K01	K02	P01	P02	P03	M01	M02	S01	S02	S03	H01	H02	O01	O02	76
-----	-----	-----	-----	-----	-----	-----	-----	-----	-----	-----	-----	-----	-----	-----	-----	-----	----

AL SE DP ENDMILLS, 4 FLUTES

- VHM AL SE DP Standard Fräser, 4 Zähne
- Frese AL SE, con passo differenziale, 4 taglienti
- Fraises AL SE DP - 4 dents
- 整体硬质合金 AL SE DP 系列 4刃平底铣刀

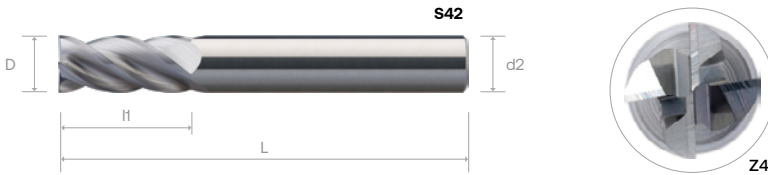

Order Number	Dimension (mm)					UC
	D	l1	l2	L	d2 (h6)	
S42 0300 057 06	3	9		57	6	•
S42 0400 057 06	4	12		57	6	•
S42 0500 057 06	5	13		57	6	•
S42 0600 057	6			57	6	•
S42 0800 064	8	20		64	8	•
S42 1000 072	10	22		72	10	•
S42 1200 083	12	26		83	12	•
S42 1400 090	14	32		90	14	•
S42 1600 092	16			92	16	•
S42 2000 104	20	38		104	20	•

CNC Repeatability
Ø1 - Ø3 within 10µm
Ø4 - Ø8 within 15µm
≥ Ø10 within 20µm

Material Group | Material-Gruppe | Groupe Matière | Gruppo Materiali | 材质主类

N01
N02
N03
K01
K02
P01
P02
P03
M01
M02
S01
S02
S03
H01
H02
O01
O02

Cutting Parameter

75

ALU LINE
 EZ LINE - ENDMILL
 SE 30
 NITICO 30
 OPTIMUM
 SE 45
 SE 45X
 NITICO 45
 SE 60
 SE 60X
 DN70 - SE70
 SE GR
 TE 45
 PLUNGE -MILL
 THREAD MILL

AL SE DP TORUS ENDMILLS, 4 FLUTES

- VHM AL SE DP Torusfräser, 4 Zähne
- Frese toroidali AL SE, con passo differenziale, raggio di protezione, 4 taglianti
- Fraises AL SE DP toriques à pas décalés 4 dents
- 整体硬质合金 AL SE DP 系列 4刃圆鼻铣刀



Order Number	Dimension (mm)							HA	Order Number	Dimension (mm)							HB
	D	I1	I2	L	d2 (h6)	R	UC			D	I1	I2	L	d2 (h6)	R	UC	
C45 0300 057 0600 030	3	9		57	6	0.3	•	C51 0300 057 0600 030	3	9		57	6	0.3	•		
C45 0300 057 0600 050				57	6	0.5	◦	C51 0300 057 0600 050				57	6	0.5	◦		
C45 0400 057 0600 030				57	6	0.3	•	C51 0400 057 0600 030				57	6	0.3	◦		
C45 0400 057 0600 050	4	12		57	6	0.5	•	C51 0400 057 0600 050	4	12		57	6	0.5	◦		
C45 0500 057 0600 030				57	6	0.3	◦	C51 0500 057 0600 030				57	6	0.3	◦		
C45 0500 057 0600 050				57	6	0.5	◦	C51 0500 057 0600 050				57	6	0.5	◦		
C45 0600 057 0600 030	5	15		57	6	0.3	•	C51 0600 057 0600 030	5	15		57	6	0.3	◦		
C45 0600 057 0600 050				57	6	0.5	◦	C51 0600 057 0600 050				57	6	0.5	◦		
C45 0600 057 0600 100				57	6	1	•	C51 0600 057 0600 100				57	6	1	◦		
C45 0800 064 0800 030	6	16		64	8	0.3	•	C51 0800 064 0800 030	6	16		64	8	0.3	◦		
C45 0800 064 0800 050				64	8	0.5	•	C51 0800 064 0800 050				64	8	0.5	◦		
C45 0800 064 0800 100				64	8	1	•	C51 0800 064 0800 100				64	8	1	◦		
C45 0800 064 0800 150	8	20		64	8	0.3	•	C51 0800 064 0800 150	8	20		64	8	0.3	◦		
C45 0800 064 0800 200				64	8	0.5	•	C51 0800 064 0800 200				64	8	0.5	◦		
C45 0800 064 0800 250				64	8	1	•	C51 0800 064 0800 250				64	8	1	◦		
C45 1000 072 1000 030	10	22		72	10	0.3	•	C51 1000 072 1000 030	10	22		72	10	0.3	◦		
C45 1000 072 1000 050				72	10	0.5	•	C51 1000 072 1000 050				72	10	0.5	◦		
C45 1000 072 1000 100				72	10	1	•	C51 1000 072 1000 100				72	10	1	◦		
C45 1200 083 1200 030	12	26		83	12	0.3	•	C51 1200 083 1200 030	12	26		83	12	0.3	◦		
C45 1200 083 1200 050				83	12	0.5	•	C51 1200 083 1200 050				83	12	0.5	◦		
C45 1200 083 1200 100				83	12	1	•	C51 1200 083 1200 100				83	12	1	◦		
C45 1200 083 1200 200	14	32		83	12	2	•	C51 1200 083 1200 200	14	32		83	12	2	◦		
C45 1200 083 1200 250				83	12	2.5	◦	C51 1200 083 1200 250				83	12	2.5	◦		
C45 1200 083 1200 300				83	12	3	•	C51 1200 083 1200 300				83	12	3	◦		
C45 1400 083 1400 050	14	32		83	14	0.5	•	C51 1400 083 1400 050	14	32		83	14	0.5	◦		
C45 1400 083 1400 100				83	14	1	◦	C51 1400 083 1400 100				83	14	1	◦		
C45 1400 083 1400 150				83	14	1.5	◦	C51 1400 083 1400 150				83	14	1.5	◦		
C45 1400 083 1400 200	16	32		83	14	2	◦	C51 1400 083 1400 200	16	32		83	14	2	◦		
C45 1400 083 1400 300				83	14	3	◦	C51 1400 083 1400 300				83	14	3	◦		
C45 1600 092 1600 030				92	16	0.3	◦	C51 1600 092 1600 030				92	16	0.3	◦		
C45 1600 092 1600 050	16	32		92	16	0.5	◦	C51 1600 092 1600 050	16	32		92	16	0.5	◦		
C45 1600 092 1600 100				92	16	1	◦	C51 1600 092 1600 100				92	16	1	◦		
C45 1600 092 1600 200				92	16	2	◦	C51 1600 092 1600 200				92	16	2	◦		
C45 1600 092 1600 250	20	38		92	16	2.5	◦	C51 1600 092 1600 250	20	38		92	16	2.5	◦		
C45 1600 092 1600 300				92	16	3	◦	C51 1600 092 1600 300				92	16	3	◦		
C45 1600 092 1600 400				92	16	4	◦	C51 1600 092 1600 400				92	16	4	◦		
C45 2000 104 2000 030	20	38		104	20	0.3	◦	C51 2000 104 2000 030	20	38		104	20	0.3	◦		
C45 2000 104 2000 050				104	20	0.5	◦	C51 2000 104 2000 050				104	20	0.5	◦		
C45 2000 104 2000 100				104	20	1	◦	C51 2000 104 2000 100				104	20	1	◦		
C45 2000 104 2000 200	20	38		104	20	2	◦	C51 2000 104 2000 200	20	38		104	20	2	◦		
C45 2000 104 2000 250				104	20	2.5	◦	C51 2000 104 2000 250				104	20	2.5	◦		
C45 2000 104 2000 300				104	20	3	◦	C51 2000 104 2000 300				104	20	3	◦		
C45 2000 104 2000 400				104	20	4	◦	C51 2000 104 2000 400				104	20	4	◦		

CNC Repeatability

Ø1 - Ø3 within 10µm

Ø4 - Ø8 within 15µm

≥ Ø10 within 20µm

Material Group | Material-Gruppe | Groupe Matière | Gruppo Materiali | 材质主类

Cutting Parameter

N01	N02	N03	K01	K02	P01	P02	P03	M01	M02	S01	S02	S03	H01	H02	O01	O02	75
-----	-----	-----	-----	-----	-----	-----	-----	-----	-----	-----	-----	-----	-----	-----	-----	-----	----

FEATURES & BENEFITS

XQ Alu Cutters

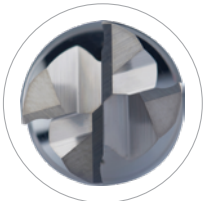

Top View

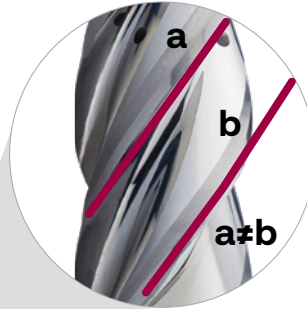

1 Differential Pitch (DP)



Provides excellent surface finishing while eliminating chatter

5 Polished Flutes



Ensures fast and effective chips evacuation and drastically reduces built-up edge

3 Differential Fluting (DF)

With optimized core diameter, counteracts the forces generated and ensures greater milling performance

2 Differential Helix (DH)



- Reduces machining vibrations allowing for high speed machining and increased productivity
- For chatter free machining and excellent surface finishing

4 Oil Hole for High Performance Milling



- Improves welding resistance
- Enables a wide range of machining processes
- Especially beneficial for difficult to cut materials, offering stable machining





1. Ungleiche Teilung (DP)
Per una lavorazione senza vibrazione e finiture superficiali eccellenti
2. Ungleiche Drallsteigung (DH)
Reduziert Bearbeitungsvibrationen und ermöglicht eine Hochgeschwindigkeitsbearbeitung und eine höhere Produktivität
Zur Schnittkraftreduzierung und Leistungssteigerung
3. Ungleiche Spannuttentiefe (DF)
Optimierter Kerndurchmesser wirkt den erzeugten Kräften entgegen und ermöglicht einen stabileren Fräsprozess
4. Große Kühlkanalbohrungen für Hochleistungsfräsen
Verbessert die Spanabfuhr
Ermöglicht umfangreiche Applikationen
Große Vorteile für die Bearbeitung festerer AluminiumlegierungenXQ
5. Polierte Schneiden
Sorgt für schnellen effizienten Spänefluß und reduziert die Bildung von Aufbauschneiden



1. 不等分割設計 (DP)
有效降低加工時的振動從而，達到更好的工件表面光潔度。
2. 不等螺旋角設計 (DH)
減少加工振動，有效提升，加工速度並提高生產率。
用于無顫振加工和出色的表面光潔度。
3. 不等槽幾何設計
優化的核心直徑，提高，溝槽容屑率並提升銑削性能。
4. 高性能油孔
切削時更能達到冷卻的效果。
降低積屑的效果從而優。
化排屑性能。
5. 拋光溝槽
快速且有效的讓鐵屑排出。
減少鐵屑堆積的機會。



1. Design del passo differenziale (DP)
Design del passo differenziale (DP) Riduce le vibrazioni, massimizza la produttività e la durata dell'utensile.
2. Elica differenziale (DH)
Riduce le vibrazioni di lavorazione, consentendo di lavorazioni ad alta velocità e maggiore produttività
Per ridurre le forze di taglio e migliorare le performance di lavorazione
3. Fluting differenziale (DF)
Con un diametro del nucleo ottimizzato, contrasta le forze generate e garantisce una maggiore prestazioni di fresatura
4. Foro dell'olio per la fresatura ad alte prestazioni
Migliora la resistenza alla saldatura
Consente un'ampia gamma di processi di lavorazione
Particolarmente utile per materiali difficili da tagliare, offrendo una lavorazione stabile
5. Flauti Lucidi
Assicura un'evacuazione rapida ed efficace dei trucioli e riduce drasticamente il bordo di costruzione



1. Conception à pas différentiel (DP)
Pour un usinage sans vibrations et un très bon état de surface
2. Conception à hélice variable (DH)
Réduit les efforts de coupes et améliore les performances d'usinage
Pour un usinage sans bavardage et un excellent état de surface
3. Cannelures différentielles (DF)
Avec un diamètre de noyau optimisé, contrecarre les forces générées et assure de meilleures performances de fraisage
4. Trou d'huile pour le fraisage haute performance
Améliore la résistance au soudage
Permet une large gamme de processus d'usinage
Particulièrement bénéfique pour les matériaux difficiles à couper, offrant un usinage stable
5. Flûtes polies
Assure une évacuation rapide et efficace des copeaux et réduit considérablement les bords accumulés

XQ ALU CUTTERS DP/DH/DF ENDMILLS, WITH RECESS, 4 FLUTES

- VHM XQ Alu Cutter DP/DH/DF Fräser, mit Spanbrecher, Innenkühlung, 4 Zähne
- Frese XQ Alu con passo differenziale, eliche a spoglie variabili, fori lubrificanti radiali, rompitruciolo, recesso, 4 taglienti
- Fraises XQ Alu à pas décalés avec hélice différente, 4 dents
- 整体硬质合金 XQ Alu Cutters DP/DH/DF 4刃平底铣刀(避空位和侧固柄)

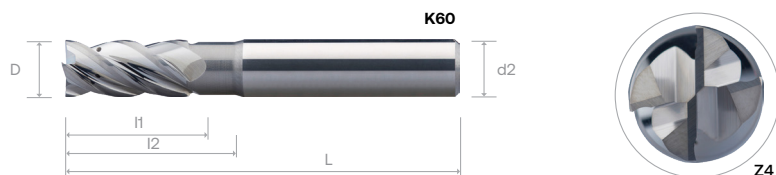

Order Number DIN 6535	Dimension (mm)						Flute Polished	
	D	I1	I2	L	d2 (h6)	C	UC	
K60 0600 *	6	13	20	57	6	0.1	•	
K60 0800 *	8	20	26	64	8	0.1	•	
K60 1000 *	10	22	30	72	10	0.2	•	
K60 1200 *	12	26	36	83	12	0.2	•	
K60 1400 *	14		38	83	14	0.2	◦	
K60 1600 *	16	32	42	92	16	0.2	•	
K60 1800 *	18		42	92	18	0.3	◦	
K60 2000 *	20	38	52	104	20	0.3	•	

* - DIN 6535

CNC Repeatability

Ø1 - Ø3 within 10µm
Ø4 - Ø8 within 15µm
≥ Ø10 within 20µm

Material Group | Material-Gruppe | Groupe Matière | Gruppo Materiali | 材质主类



Cutting Parameter

76 - 77



XQ ALU CUTTERS DP/DH/DF ENDMILLS, WITH CHIP BREAKER, RECESS, 4 FLUTES

- VHM XQ Alu Cutter DP/DH/DF Fräser, mit Spanbrecher, Innenkühlung, 4 Zähne
- Frese XQ Alu con passo differenziale, eliche a spoglie variabili, fori lubrificanti radiali, rompitruciolo, recesso, 4 taglienti
- Fraises XQ Alu à pas décalés avec hélice différentielle, brise-copeaux, évidement, 4 dents
- 整体硬质合金 XQ Alu Cutters DP/DH/DF 4刃平底铣刀(断屑槽、避空位和侧固柄)

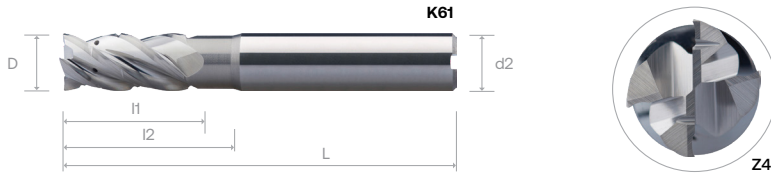
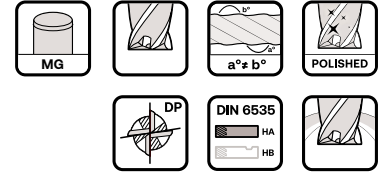

Order Number DIN 6535	Dimension (mm)						Flute Polished	
	D	I 1	I 2	L	d2 (h6)	C	UC	
K61 0600 *	6	13	20	57	6	0.1	•	
K61 0800 *	8	20	26	64	8	0.1	•	
K61 1000 *	10	22	30	72	10	0.2	•	
K61 1200 *	12	26	36	83	12	0.2	•	
K61 1400 *	14		38	83	14	0.2	•	
K61 1600 *	16	32	42	92	16	0.2	•	
K61 1800 *	18		42	92	18	0.3	•	
K61 2000 *	20	38	52	104	20	0.3	•	

* - DIN 6535

CNC Repeatability
Ø1 - Ø3 within 10µm
Ø4 - Ø8 within 15µm
≥ Ø10 within 20µm

Material Group | Material-Gruppe | Groupe Matière | Gruppo Materiali | 材质主类

N01	N02	N03	K01	K02	P01	P02	P03	M01	M02	S01	S02	S03	H01	H02	O01	O02	76 - 77
-----	-----	-----	-----	-----	-----	-----	-----	-----	-----	-----	-----	-----	-----	-----	-----	-----	---------

Cutting Parameter

ALU LINE
EZ LINE - ENDMILL
SE 30
NITCo 30
OPTIMUM
SE 45
SE 45X
SE 45X
NITCo 45
SE 60
SE 60X
DM70 - SE70
SE GR
TE 45
PLUNGE -MILL
THREAD MILL

FEATURES & BENEFITS

XQ Alu Cutters



Top View



1 Differential Pitch (DP)



Provides excellent surface finishing while eliminating chatter

4 Oil Hole for High Performance Milling



- Improves welding resistance
- Enables a wide range of machining processes
- Especially beneficial for difficult to cut materials, offering stable machining

5 Polished Flutes



Ensures fast and effective chips evacuation and drastically reduces built-up edge

3 Differential Fluting (DF)

With optimized core diameter, counteracts the forces generated and ensures greater milling performance

6 Corner Radius



- Reducing chipping and providing longer tool life
- Standardized corner radius for aerospace components

7 Chipbreakers

Efficiently shears work materials and shortens chips for improved chips removal

2 Differential Helix (DH)



- Reduces machining vibrations allowing for high speed machining and increased productivity
- For chatter free machining and excellent surface finishing





1. Ungleiche Teilung (DP)
Per una lavorazione senza vibrazione e finiture superficiali eccellenti
2. Ungleiche Drallsteigung (DH)
Reduziert Bearbeitungsvibrationen und ermöglicht eine Hochgeschwindigkeitsbearbeitung und eine höhere Produktivität
3. Ungleiche Spannuttentiefe (DF)
Optimierter Kerndurchmesser wirkt den erzeugten Kräften entgegen und ermöglicht einen stabileren Fräsprozess
4. Große Kühlkanalbohrungen für Hochleistungsfräsen
Verbessert die Spanabfuhr
Ermöglicht umfangreiche Applikationen
Große Vorteile für die Bearbeitung festerer Aluminiumlegierungen XQ
5. Polierte Schneiden
Sorgt für schnellen effizienten Spänefluß und reduziert die Bildung von Aufbauschnitten
6. Eckenradius
Eckenradius hervorragender Schneideckenschutz sorgt für längere Werkzeuglebensdauer genormte Eckenradien für Aerospace Bauteile
Standardisierter Eckenradius für Aerospace-Komponenten (XQ Alu)
7. Spanbrecher
Sorgt für kurze Späne auch bei langspanenden Werkstoffen und verhindert somit Spanstau im Prozess und bei der Spanabfuhr



1. 不等分割設計 (DP)
有效降低加工時的振動從而，達到更好的工件表面光潔度。
2. 不等螺旋角設計 (DH)
減少加工振動，有效提升，加工速度並提高生產率。
用于無顛振加工和出色的表面光潔度。
3. 不等槽幾何設計
優化的核心直徑，提高，溝槽容屑率並提升銑削性能。
4. 高性能油孔
切削時更能達到冷卻的效果。
降低積屑的效果從而優。
化排屑性能。
5. 拋光溝槽
快速且有效的讓鐵屑排出。
減少鐵屑堆積的機會。
6. 拐角半徑
減少碎屑并延長刀具壽命。
航空航天部件的標準化圓角半徑 (XQ Alu)。
7. 使用斷屑槽優化几何
高效剪切工作材料. 并縮短切屑以改善排屑。



1. Design del passo differenziale (DP)
Design del passo differenziale (DP) Riduce le vibrazioni, massimizza la produttività e la durata dell'utensile.
2. Elica differenziale (DH)
Riduce le vibrazioni di lavorazione, consentendo di lavorazioni ad alta velocità e maggiore produttività
Per ridurre le forze di taglio e migliorare le performance di lavorazione
3. Fluting differenziale (DF)
Con un diametro del nucleo ottimizzato, contrasta le forze generate e garantisce una maggiore prestazioni di fresatura
4. Foro dell'olio per la fresatura ad alte prestazioni
Migliora la resistenza alla saldatura
Consente un'ampia gamma di processi di lavorazione
Particolarmente utile per materiali difficili da tagliare, offrendo una lavorazione stabile
5. Flauti Lucidi
Assicura un'evacuazione rapida ed efficace dei trucioli
riduce drasticamente il bordo di costruzione
6. Raggio d'angolo
Riduzione dei trucioli e maggiore durata dell'utensile
Raggio d'angolo standardizzato per componenti aerospaziali (XQ Alu)
7. Rompitrucioli
Taglia in modo efficiente i materiali di lavoro e accorcia i trucioli per una migliore rimozione dei trucioli



1. Conception à pas différentiel (DP)
Pour un usinage sans vibrations et un très bon état de surface
2. Conception à hélice variable (DH)
Réduit les efforts de coupes et améliore les performances d'usinage
Pour un usinage sans bavardage et un excellent état de surface
3. Cannelures différentielles (DF)
Avec un diamètre de noyau optimisé, contrecarre les forces générées et assure de meilleures performances de fraisage
4. Trou d'huile pour le fraisage haute performance
Améliore la résistance au soudage
Permet une large gamme de processus d'usinage
Particulièrement bénéfique pour les matériaux difficiles à couper, offrant un usinage stable
5. Flûtes polies
Assure une évacuation rapide et efficace des copeaux et réduit considérablement les bords accumulés
6. Rayon d'angle
Réduire l'écaillage et prolonger la durée de vie de l'outil
Rayon d'angle normalisé pour les composants aérospatiaux (XQ Alu)
7. Brise-copeaux
Cisaille efficacement les matériaux de travail et raccourcit les copeaux pour une meilleure élimination des copeaux

XQ ALU CUTTERS DP/DH/DF TORUS ENDMILLS, WITH RECESS, 4 FLUTES

- VHM XQ Alu Cutter DP/DH/DF Torusfräser, mit Innenkühlung, 4 Zähne
- Frese toroidali XQ Alu con passo differenziale, eliche a spoglie variabili, fori lubrificanti radiali, recesso, 4 taglienti
- Fraises XQ Alu toriques à pas décalés avec hélice différente, 4 dents
- 整体硬质合金 XQ Alu Cutters DP/DH/DF 4刃圆鼻铣刀(避空位和侧固柄)

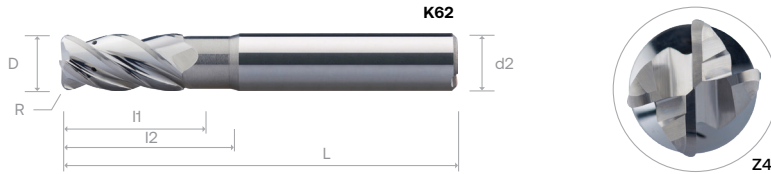
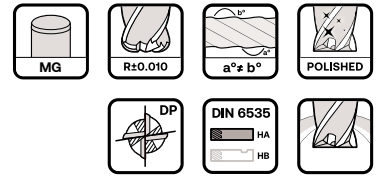

Order Number DIN 6535	Dimension (mm)						Flute Polished
	D	l1	l2	L	d2 (h6)	R	UC
K62 1000 072 1000 200 *	10	22	30	72	10	2	•
K62 1000 072 1000 250 *			30	72	10	2.5	◦
K62 1000 072 1000 300 *			30	72	10	3	•
K62 1000 072 1000 400 *			30	72	12	4	•
K62 1200 083 1200 200 *	12	26	36	83	12	2	•
K62 1200 083 1200 250 *			36	83	12	2.5	◦
K62 1200 083 1200 300 *			36	83	12	3	◦
K62 1200 083 1200 400 *			36	83	12	4	•
K62 1600 092 1600 200 *	16	32	42	92	16	2	•
K62 1600 092 1600 250 *			42	92	16	2.5	◦
K62 1600 092 1600 300 *			42	92	16	3	◦
K62 1600 092 1600 400 *			42	92	16	4	◦
K62 2000 104 2000 200 *	20	38	52	104	20	2	◦
K62 2000 104 2000 250 *			52	104	20	2.5	◦
K62 2000 104 2000 300 *			52	104	20	3	◦
K62 2000 104 2000 400 *			52	104	20	4	◦

* - DIN 6535

CNC Repeatability
Ø1 - Ø3 within 10µm
Ø4 - Ø8 within 15µm
≥ Ø10 within 20µm

Material Group | Material-Gruppe | Groupe Matière | Gruppo Materiali | 材质主类



Cutting Parameter

76 - 77

ALU LINE
 EZ LINE - ENDMILL
 SE 30
 NITICO 30
 OPTIMUM
 SE 45
 SE 45X
 NITICO 45
 SE 60
 SE 60X
 DN70 - SE 70
 SE GR
 TE 45
 PLUNGE -MILL
 THREAD MILL

XQ ALU CUTTERS DP/DH/DF TORUS ENDMILLS, WITH CHIP BREAKER, RECESS, 4 FLUTES

- VHM XQ Alu Cutter DP/DH/DF Torusfräser, mit Spanbrecher, Innenkühlung, 4 Zähne
- Frese toroidali XQ Alu con passo differenziale, eliche a spoglie variabili, fori lubrificanti radiali, rompitruciolo, recesso, 4 taglienti
- Fraises XQ Alu toriques à pas décalés avec hélice différente, avec brise-copeaux, 4 dents
- 整体硬质合金 XQ Alu Cutters DP/DH/DF 4刃圆鼻铣刀(断屑槽、避空位和侧固柄)

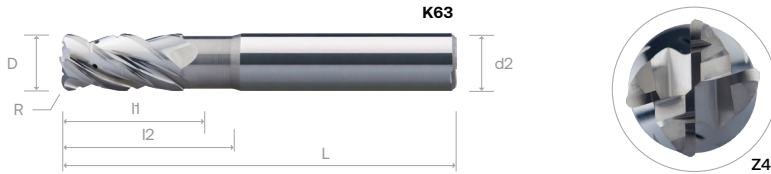
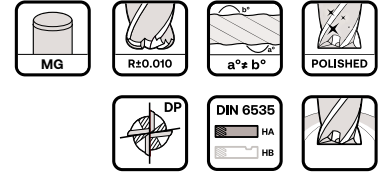

Order Number DIN 6535	Dimension (mm)						Flute Polished	
	D	I1	I2	L	d2 (h6)	R	UC	
K63 1000 072 1000 200 *	10	22	30	72	10	2	°	
K63 1000 072 1000 250 *			30	72	10	2.5	•	
K63 1000 072 1000 300 *			30	72	10	3	•	
K63 1000 072 1000 400 *	12	26	30	72	12	4	•	
K63 1200 083 1200 200 *			36	83	12	2	°	
K63 1200 083 1200 250 *			36	83	12	2.5	•	
K63 1200 083 1200 300 *			36	83	12	3	•	
K63 1200 083 1200 400 *	16	32	36	83	12	4	•	
K63 1600 092 1600 200 *			42	92	16	2	•	
K63 1600 092 1600 250 *			42	92	16	2.5	•	
K63 1600 092 1600 300 *			42	92	16	3	•	
K63 1600 092 1600 400 *	20	38	42	92	16	4	•	
K63 2000 104 2000 200 *			52	104	20	2	•	
K63 2000 104 2000 250 *			52	104	20	2.5	•	
K63 2000 104 2000 300 *			52	104	20	3	•	
K63 2000 104 2000 400 *			52	104	20	4	•	

* - DIN 6535

CNC Repeatability
Ø1 - Ø3 within 10µm
Ø4 - Ø8 within 15µm
≥ Ø10 within 20µm

Material Group | Material-Gruppe | Groupe Matière | Gruppo Materiali | 材质主类

Cutting Parameter

N01	N02	N03	K01	K02	P01	P02	P03	M01	M02	S01	S02	S03	H01	H02	O01	O02	76 - 77
-----	-----	-----	-----	-----	-----	-----	-----	-----	-----	-----	-----	-----	-----	-----	-----	-----	---------

XQ ALU CUTTERS DP/DH/DF LONG ENDMILLS, WITH RECESS, 4 FLUTES

- VHM XQ Alu Cutter DP/DH/DF High Performance Fräser, lang, mit Innenkühlung, 4 Zähne
- Frese lunghe XQ Alu, con passo differenziale, eliche a spoglie variabili, recesso, weldon, 4 taglienti
- Fraises XQ Alu longues à pas décalés avec hélice différente, 4 dents
- 整体硬质合金 XQ Alu Cutters DP/DH/DF 4刃长型平底铣刀(避空位)

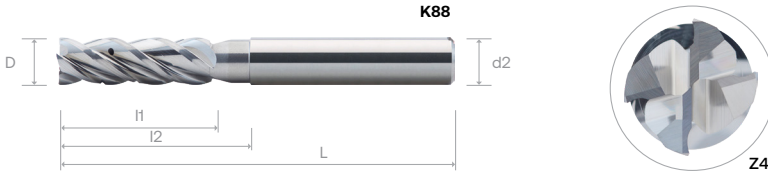

Order Number DIN 6535	Dimension (mm)						Flute Polished	
	D	I1	I2	L	d2 (h6)	C	UC	
K88 0600	6	10	30	68	6	0.1	o	
K88 0800 *	8	15	34	72	8	0.1	o	
K88 1000	10	18	40	83	10	0.2	o	
K88 1200 *	12	22	50	95	12	0.2	o	
K88 1600	16	26	62	110	16	0.2	o	
K88 2000	20	30	75	150	20	0.3	o	

* - DIN 6535

ALU LINE
 EZ LINE - ENDMILL
 SE 30
 NITICO 30
 OPTIMUM
 SE 45
 SE 45X
 NITICO 45
 SE 60
 SE 60X
 DN70 - SE 70
 SE GR
 TE 45
 PLUNGE -MILL
 THREAD MILL

CNC Repeatability
Ø1 - Ø3 within 10µm
Ø4 - Ø8 within 15µm
≥ Ø10 within 20µm

Material Group | Material-Gruppe | Groupe Matière | Gruppo Materiali | 材质主类

N01
N02
N03
K01
K02
P01
P02
P03
M01
M02
S01
S02
S03
H01
H02
O01
O02

Cutting Parameter

82

XQ ALU CUTTERS DP/DH/DF LONG ENDMILLS, WITH RECESS AND CHIPBREAKER, 4 FLUTES

- VHM XQ Alu Cutter DP/DH/DF High Performance Fräser, lang, mit Spanbrecher, Innenkühlung, 4 Zähne
- Frese lunghe XQ Alu, con passo differenziale, eliche a spoglie variabili, rompitrucciolo, recesso, 4 taglienti
- Fraises XQ Alu longues à pas décalés avec hélice différente, avec brise-copeaux, 4 dents
- 整体硬质合金 XQ Alu Cutters DP/DH/DF 4刃长型铣刀(避空位和断屑槽)

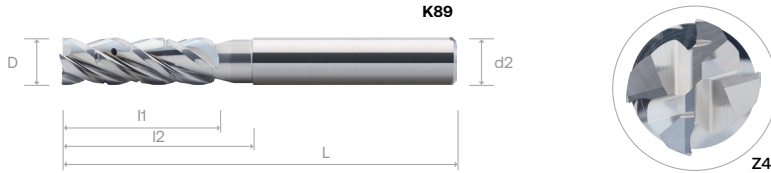
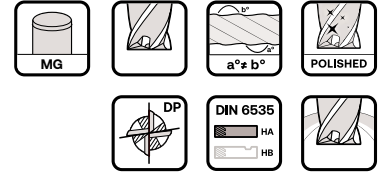

Order Number DIN 6535	Dimension (mm)						Flute Polished	
	D	I1	I2	L	d2 (h6)	C	UC	
K89 0600 *	6	20	30	68	6	0.1	o	
K89 0800 *	8	26	34	72	8	0.1	o	
K89 1000	10	32	40	83	10	0.2	o	
K89 1200 *	12	38	50	95	12	0.2	o	
K89 1600 *	16	50	62	110	16	0.2	o	
K89 2000	20	60	75	150	20	0.3	o	

* - DIN 6535

CNC Repeatability
Ø1 - Ø3 within 10µm
Ø4 - Ø8 within 15µm
≥ Ø10 within 20µm

Material Group | Material-Gruppe | Groupe Matière | Gruppo Materiali | 材质主类

Cutting Parameter

N01	N02	N03	K01	K02	P01	P02	P03	M01	M02	S01	S02	S03	H01	H02	O01	O02	82
-----	-----	-----	-----	-----	-----	-----	-----	-----	-----	-----	-----	-----	-----	-----	-----	-----	----

AL SE MINIATURE ENDMILLS WITH LONG NECK, 2 FLUTES

- VHM AL SE Kleinstfräser mit langem Hals, 2 Zähne
- Micro-frese AL SE, con collo conico lungo, 2 taglienti
- Micro-fraises AL SE avec cou long, 2 dents
- 整体硬质合金 AL SE 系列 微小径2刀长颈平底铣刀

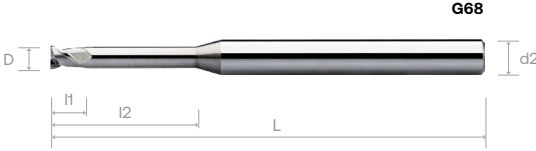

Order Number	Dimension (mm)						UC	Order Number	Dimension (mm)						UC	
	D	l1	l2	L	d1	d2 (r6)			D	l1	l2	L	d1	d2 (r6)		
G68 0020 050 0400	0.2	0.3	-	50	-	4	o	G68 0140 050 0400	1.4	2.1	-	50	-	4	o	
G68 0020 050 0400 005			0.5	50	0.17	4	o				G68 0140 050 0400 060	6	50	1.3	4	o
G68 0020 050 0400 010			1	50	0.17	4	•				G68 0140 050 0400 080	8	50	1.3	4	o
G68 0020 050 0400 015	0.3	0.4	1.5	50	0.17	4	•	G68 0140 050 0400 100	10	50	1.3	4	•			
G68 0030 050 0400			-	50	-	4	o	G68 0140 050 0400 120	12	50	1.3	4	o			
G68 0030 050 0400 010			1	50	0.27	4	•	G68 0140 050 0400 140	14	50	1.3	4	o			
G68 0030 050 0400 020	0.4	0.6	2	50	0.27	4	•	G68 0140 050 0400 160 *	16	50	1.3	4	o			
G68 0030 050 0400 030			3	50	0.27	4	o	G68 0150 050 0400	-	50	-	4	o			
G68 0040 050 0400			-	50	-	4	o	G68 0150 050 0400 060	6	50	1.4	4	•			
G68 0040 050 0400 020	0.5	0.7	2	50	0.37	4	•	G68 0150 050 0400 080	8	50	1.4	4	•			
G68 0040 050 0400 030			3	50	0.37	4	o	G68 0150 050 0400 100	10	50	1.4	4	o			
G68 0040 050 0400 040			4	50	0.37	4	o	G68 0150 050 0400 120	12	50	1.4	4	o			
G68 0040 050 0400 050	0.6	0.9	5	50	0.37	4	•	G68 0150 050 0400 140	14	50	1.4	4	o			
G68 0050 050 0400			-	50	-	4	o	G68 0150 050 0400 160 *	16	50	1.4	4	•			
G68 0050 050 0400 020			2	50	0.45	4	•	G68 0150 060 0400	-	60	-	4	o			
G68 0050 050 0400 040	0.7	1.0	4	50	0.45	4	•	G68 0150 060 0400 180	18	60	1.4	4	•			
G68 0050 050 0400 060			6	50	0.45	4	•	G68 0150 060 0400 200	20	60	1.4	4	o			
G68 0050 050 0400 080			8	50	0.45	4	•	G68 0160 050 0400	-	50	-	4	o			
G68 0060 050 0400	0.8	1.2	-	50	-	4	o	G68 0160 050 0400 060	6	50	1.5	4	•			
G68 0060 050 0400 020			2	50	0.55	4	o	G68 0160 050 0400 080	8	50	1.5	4	o			
G68 0060 050 0400 040			4	50	0.55	4	•	G68 0160 050 0400 100	10	50	1.5	4	o			
G68 0060 050 0400 060	0.9	1.4	6	50	0.55	4	•	G68 0160 050 0400 120	12	50	1.5	4	o			
G68 0060 050 0400 080			8	50	0.55	4	•	G68 0160 050 0400 140	14	50	1.5	4	o			
G68 0060 050 0400 100			10	50	0.55	4	o	G68 0160 050 0400 160 *	16	50	1.5	4	o			
G68 0070 050 0400	1.0	1.5	-	50	-	4	o	G68 0160 060 0400	-	60	-	4	o			
G68 0070 050 0400 020			2	50	0.65	4	o	G68 0160 060 0400 180	18	60	1.5	4	o			
G68 0070 050 0400 040			4	50	0.65	4	•	G68 0160 060 0400 200	20	60	1.5	4	o			
G68 0070 050 0400 060	1.2	1.8	6	50	0.65	4	o	G68 0180 050 0400	-	50	-	4	o			
G68 0070 050 0400 080			8	50	0.65	4	o	G68 0180 050 0400 060	6	50	1.7	4	o			
G68 0070 050 0400 100			10	50	0.65	4	o	G68 0180 050 0400 080	8	50	1.7	4	o			
G68 0080 050 0400	1.4	2.1	-	50	-	4	o	G68 0180 050 0400 100	10	50	1.7	4	o			
G68 0080 050 0400 040			4	50	0.75	4	o	G68 0180 050 0400 120	12	50	1.7	4	o			
G68 0080 050 0400 060			6	50	0.75	4	•	G68 0180 050 0400 140	14	50	1.7	4	o			
G68 0080 050 0400 080	1.8	2.7	8	50	0.75	4	o	G68 0180 050 0400 160 *	16	50	1.7	4	o			
G68 0080 050 0400 100			10	50	0.75	4	o	G68 0180 060 0400	-	60	-	4	o			
G68 0080 050 0400 120			12	50	0.75	4	•	G68 0180 060 0400 180	18	60	1.7	4	o			
G68 0090 050 0400	2.0	3.0	-	50	-	4	o	G68 0180 060 0400 200	20	60	1.7	4	o			
G68 0090 050 0400 060			6	50	0.85	4	•	G68 0200 050 0400	-	50	-	4	o			
G68 0090 050 0400 080			8	50	0.85	4	o	G68 0200 050 0400 060	6	50	1.9	4	o			
G68 0090 050 0400 100	2.5	3.7	10	50	0.85	4	o	G68 0200 050 0400 080	8	50	1.9	4	•			
G68 0090 050 0400 150 *			15	50	0.85	4	o	G68 0200 050 0400 100	10	50	1.9	4	•			
G68 0100 050 0400			-	50	-	4	o	G68 0200 050 0400 120	12	50	1.9	4	•			
G68 0100 050 0400 060	1.0	1.5	6	50	0.9	4	•	G68 0200 050 0400 140	14	50	1.9	4	o			
G68 0100 050 0400 080			8	50	0.9	4	o	G68 0200 050 0400 160	16	50	1.9	4	•			
G68 0100 050 0400 100			10	50	0.9	4	o	G68 0200 060 0400	-	60	-	4	o			
G68 0100 050 0400 120	1.2	1.8	12	50	0.9	4	•	G68 0200 060 0400 180	18	60	1.9	4	•			
G68 0100 050 0400 140			14	50	0.9	4	•	G68 0200 060 0400 200	20	60	1.9	4	•			
G68 0100 050 0400 160 *			16	50	0.9	4	o	G68 0200 075 0400	-	75	-	4	o			
G68 0120 050 0400	1.2	1.8	-	50	-	4	o	G68 0200 075 0400 250	25	75	1.9	4	•			
G68 0120 050 0400 060			6	50	1.1	4	o	G68 0200 075 0400 300	30	75	1.9	4	•			
G68 0120 050 0400 080			8	50	1.1	4	o	G68 0250 050 0400	-	50	-	4	o			
G68 0120 050 0400 100	2.5	3.7	10	50	1.1	4	o	G68 0250 050 0400 080	8	50	2.4	4	o			
G68 0120 050 0400 120			12	50	1.1	4	o	G68 0250 050 0400 100	10	50	2.4	4	o			

* - DIN 6535

cont'd ▶

Material Group | Material-Gruppe | Groupe Matiere | Gruppo Materiali | 材质主类

Cutting Parameter

N01	N02	N03	K01	K02	P01	P02	P03	M01	M02	S01	S02	S03	H01	H02	O01	O02
-----	-----	-----	-----	-----	-----	-----	-----	-----	-----	-----	-----	-----	-----	-----	-----	-----

77 - 79

AL SE MINIATURE ENDMILLS WITH LONG NECK, 2 FLUTES

- VHM AL SE Kleinfräser mit langem Hals, 2 Zähne
- Micro-frese AL SE, con collo conico lungo, 2 taglienti
- Micro-fraises AL SE avec cou long, 2 dents
- 整体硬质合金 AL SE 系列 微小径2刃长颈平底铣刀



Order Number	Dimension (mm)						UC	Order Number	Dimension (mm)						UC		
	D	I1	I2	L	d1	d2 (h6)			D	I1	I2	L	d1	d2 (h6)			
G68 0250 050 0400 120	2.5	3.7	12	50	2.4	4	°										
G68 0250 050 0400 140			14	50	2.4	4	°										
G68 0250 050 0400 160			16	50	2.4	4	•										
G68 0250 060 0400			-	60	-	4	°										
G68 0250 060 0400 180			18	60	2.4	4	°										
G68 0250 060 0400 200			20	60	2.4	4	•										
G68 0250 060 0400 250			25	60	2.4	4	•										
G68 0250 075 0400			-	75	-	4	°										
G68 0250 075 0400 300			30	75	2.4	4	°										
G68 0300 050 0600			-	50	-	6	°										
G68 0300 050 0600 080 *	3	4.5	8	50	2.8	6	•										
G68 0300 050 0600 100			10	50	2.8	6	°										
G68 0300 050 0600 120			12	50	2.8	6	•										
G68 0300 050 0600 140			14	50	2.8	6	•										
G68 0300 060 0600			-	60	-	6	°										
G68 0300 060 0600 160			16	60	2.8	6	•										
G68 0300 060 0600 180 *			18	60	2.8	6	•										
G68 0300 060 0600 200			20	60	2.8	6	•										
G68 0300 075 0600			-	75	2.8	6	°										
G68 0300 075 0600 250			25	75	2.8	6	°										
G68 0400 060 0600	-	60	-	6	°												
G68 0400 060 0600 100	4	4.5	10	60	3.7	6	°										
G68 0400 060 0600 150			15	60	3.7	6	°										
G68 0400 060 0600 200			20	60	3.7	6	•										
G68 0400 075 0600			-	75	3.7	6	°										
G68 0400 075 0600 250			25	75	3.7	6	•										
G68 0400 075 0600 300			30	75	3.7	6	•										
G68 0400 075 0600 400			40	75	3.7	6	•										

* - DIN 6535

Material Group | Material-Gruppe | Groupe Matière | Gruppo Materiali | 材质主类

Cutting Parameter

N01	N02	N03	K01	K02	P01	P02	P03	M01	M02	S01	S02	S03	H01	H02	O01	O02	77 - 79
-----	-----	-----	-----	-----	-----	-----	-----	-----	-----	-----	-----	-----	-----	-----	-----	-----	---------

AL BN BALLNOSE CUTTERS, 2 FLUTES

- VHM Standard AL-BN Radiuschaftfräser, 2 Zähne
- Frese sferiche AL-BN, 2 taglienti
- Fraises AL-BN en carbure monobloc, à bout hémisphérique, 2 dents
- 整体硬质合金 AL BN 系列 2刃球头铣刀

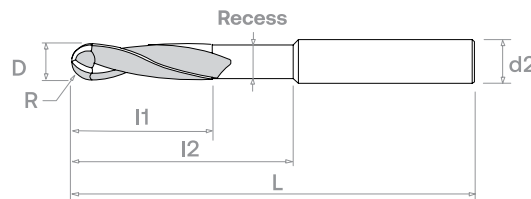
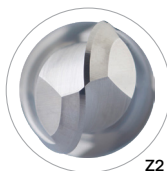
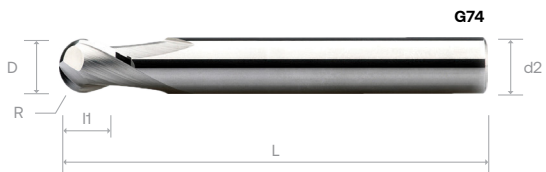
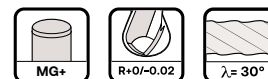

Order Number	Dimension (mm)							UC	Order Number	Dimension (mm)							UC
	D	R	I1	I2	d3	L	d2 (h6)			D	R	I1	I2	d3	L	d2 (h6)	
G74 0300	3	1.5	5		2.8	57	6	°	G75 0300	3	1.5	5	20	2.8	57	6	•
G74 0400	4	2	6		3.7	57	6	•	G75 0400	4	2	6	20	3.7	57	6	°
G74 0500	5	2.5	7		4.6	57	6	•	G75 0500	5	2.5	7	20	4.6	57	6	•
G74 0600	6	3	8		5.5	57	6	•	G75 0600 *	6	3	8	20	5.5	57	6	•
G74 0800	8	4	10		7.4	64	8	•	G75 0800	8	4	10	25	7.4	64	8	•
G74 1000	10	5	12		9.2	75	10	•	G75 1000	10	5	12	35	9.2	75	10	°
G74 1200	12	6	14		11	75	12	•	G75 1200	12	6	14	35	11	75	12	•
G74 1600	16	8	18		15	90	16	•	G75 1600	16	8	18	45	15	90	16	•
G74 2000	20	10	22		19	100	20	°	G75 2000 *	20	10	22	50	19	100	20	°

* - DIN 6535

AU LINE
 EZ LINE -
 ENDMILL
 SE 30
 NITICO 30
 OPTIMUM
 SE 45
 SE 45X
 NITICO 45
 SE 60
 SE 60X
 DN70 -
 SE 70
 SE GR
 TE 45
 PLUNGE
 -MILL
 THREAD
 MILL

Ø mm	Tol. µm
~ Ø2.5	+0 -0.020
Ø3 ~ Ø6	+0 -0.025
>Ø6	+0 -0.030

Material Group | Material-Gruppe | Groupe Matière | Gruppo Materiali | 材质主类



Cutting Parameter

79 - 80

AL BN MINIATURE BALLNOSE CUTTERS WITH LONG NECK, 2 FLUTES

- VHM Kleinst-Radiusfräser AL BN mit langem Hals, 2 Zähne
- Micro-frese sferiche AL-BN, con collo lungo, 2 taglianti
- Micro-fraises AL BN hémisphérique avec degagement, 2 dents
- 整体硬质合金 AL BN 系列 微小径2刃长颈球头铣刀

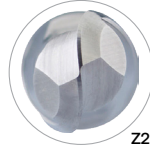
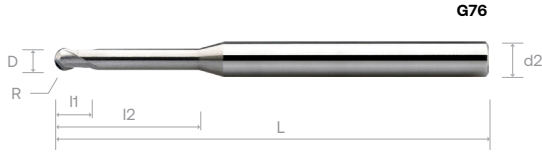

Order Number	Dimension (mm)							UC	Order Number	Dimension (mm)							UC		
	D	R	I1	I2	L	d1	d2(h6)			D	R	I1	I2	L	d1	d2(h6)			
G76 0020 050 0400	0.2	0.10	0.2	-	50	-	4	o	G76 0150 050 0400	1.5	0.75	1.2	-	50	-	4	o		
G76 0020 050 0400 005				0.5	50	0.17	4	o					G76 0150 050 0400 080	8	50	1.4	4	o	
G76 0020 050 0400 010				1	50	0.17	4	•					G76 0150 050 0400 120	12	50	1.4	4	•	
G76 0020 050 0400 015				1.5	50	0.17	4	•					G76 0150 050 0400 160 *	16	50	1.4	4	•	
G76 0030 050 0400	0.3	0.15	0.3	-	50	-	4	o	G76 0160 050 0400	1.6	0.80	1.3	-	60	-	4	o		
G76 0030 050 0400 010				1	50	0.27	4	o					G76 0160 060 0400 120	12	50	1.5	4	o	
G76 0030 050 0400 020				2	50	0.27	4	•					G76 0160 060 0400 160 *	16	50	1.5	4	•	
G76 0030 050 0400 030				3	50	0.27	4	o					G76 0160 060 0400 200	20	60	1.5	4	o	
G76 0040 050 0400	0.4	0.20	0.4	-	50	-	4	o	G76 0180 050 0400	1.8	0.90	1.4	-	50	-	4	o		
G76 0040 050 0400 010				1	50	0.37	4	•					G76 0180 050 0400 080	8	50	1.7	4	o	
G76 0040 050 0400 020				2	50	0.37	4	o					G76 0180 050 0400 120	12	50	1.7	4	o	
G76 0040 050 0400 030				3	50	0.37	4	o					G76 0180 050 0400 160 *	16	50	1.7	4	o	
G76 0040 050 0400 040	0.5	0.25	0.4	-	50	-	4	o	G76 0180 060 0400	2	1	1.6	-	60	-	4	o		
G76 0040 050 0400 050				5	50	0.37	4	•					G76 0200 050 0400	-	50	-	4	•	
G76 0050 050 0400				-	50	-	4	o					G76 0200 050 0400 040	4	50	1.9	4	•	
G76 0050 050 0400 020				2	50	0.45	4	o					G76 0200 050 0400 060	6	50	1.9	4	•	
G76 0050 050 0400 030	0.6	0.30	0.5	3	50	0.45	4	o	G76 0200 050 0400 080	8	50	1.9	4	•					
G76 0050 050 0400 040				4	50	0.45	4	•	G76 0200 050 0400 100	10	50	1.9	4	•					
G76 0050 050 0400 050				5	50	0.45	4	o	G76 0200 050 0400 120	12	50	1.9	4	•					
G76 0050 050 0400 060				6	50	0.45	4	o	G76 0200 050 0400 140	14	50	1.9	4	•					
G76 0050 050 0400 080	0.8	0.40	0.6	8	50	0.45	4	o	G76 0200 050 0400 160	16	50	1.9	4	•					
G76 0060 050 0400				-	50	-	4	o	G76 0200 060 0400	-	60	-	4	o					
G76 0060 050 0400 020				2	50	0.55	4	o	G76 0200 060 0400 180	18	60	1.9	4	•					
G76 0060 050 0400 030				3	50	0.55	4	o	G76 0200 060 0400 200	20	60	1.9	4	•					
G76 0060 050 0400 040	1.0	0.50	0.8	4	50	0.55	4	•	G76 0200 075 0400	-	75	-	4	o					
G76 0060 050 0400 050				5	50	0.55	4	o	G76 0200 075 0400 250	25	75	1.9	4	•					
G76 0060 050 0400 060				6	50	0.55	4	•	G76 0200 075 0400 300	30	75	1.9	4	•					
G76 0060 050 0400 080				8	50	0.55	4	o	G76 0300 050 0600	-	50	-	6	o					
G76 0080 050 0400	1.2	0.60	1.0	-	50	-	4	o	G76 0300 050 0600 080 *	8	50	2.8	6	•					
G76 0080 050 0400 020				2	50	0.75	4	•	G76 0300 050 0600 100	10	50	2.8	6	•					
G76 0080 050 0400 040				4	50	0.75	4	o	G76 0300 060 0600	-	60	-	6	o					
G76 0080 050 0400 050				5	50	0.75	4	•	G76 0300 060 0600 160	16	60	2.8	6	o					
G76 0080 050 0400 060	1.4	0.70	1.1	6	50	0.75	4	o	G76 0300 060 0600 200	20	60	2.8	6	•					
G76 0080 050 0400 070				7	50	0.75	4	o	G76 0300 075 0600	-	75	-	6	o					
G76 0080 050 0400 080				8	50	0.75	4	o	G76 0300 075 0600 250	25	75	2.8	6	•					
G76 0080 050 0400 100				10	50	0.75	4	o	G76 0300 075 0600 300	30	75	2.8	6	•					
G76 0100 050 0400	1.4	0.70	1.1	-	50	-	4	o	G76 0400 050 0600	-	50	-	6	o					
G76 0100 050 0400 030				3	50	0.9	4	o	G76 0400 050 0600 100	10	50	3.7	6	o					
G76 0100 050 0400 040				4	50	0.9	4	•	G76 0400 060 0600	-	60	-	6	o					
G76 0100 050 0400 050				5	50	0.9	4	•	G76 0400 060 0600 160	16	60	3.7	6	•					
G76 0100 050 0400 060	1.4	0.70	1.1	6	50	0.9	4	•	G76 0400 060 0600 200	20	60	3.7	6	•					
G76 0100 050 0400 070				7	50	0.9	4	o	G76 0400 075 0600	-	75	-	6	o					
G76 0100 050 0400 080				8	50	0.9	4	o	G76 0400 075 0600 250	25	75	3.7	6	•					
G76 0100 050 0400 090				9	50	0.9	4	•	G76 0400 075 0600 300	30	75	3.7	6	•					
G76 0100 050 0400 100	1.4	0.70	1.1	10	50	0.9	4	o	G76 0400 100 0600	-	100	-	6	o					
G76 0100 050 0400 120				12	50	0.9	4	•	G76 0400 100 0600 400	40	100	3.7	6	•					
G76 0100 050 0400 140				14	50	0.9	4	•	G76 0400 100 0600 450	45	100	3.7	6	o					
G76 0100 050 0400 160				16	50	0.9	4	o	G76 0400 100 0600 500	50	100	3.7	6	o					
G76 0120 050 0400	1.2	0.60	1.0	-	50	-	4	o											
G76 0120 050 0400 060				6	50	1.1	4	•											
G76 0120 050 0400 080				8	50	1.1	4	o											
G76 0120 050 0400 100				10	50	1.1	4	o											
G76 0120 050 0400 120	1.2	0.60	1.0	12	50	1.1	4	o											
G76 0140 050 0400				-	50	-	4	o											
G76 0140 050 0400 080				8	50	1.3	4	o											
G76 0140 050 0400 120				12	50	1.3	4	o											
G76 0140 050 0400 160 *	16	50	1.3	4	o														

* - DIN 6535

Material Group | Material-Gruppe | Groupe Matiere | Gruppo Materiali | 材质主类

Cutting Parameter

N01	N02	N03	K01	K02	P01	P02	P03	M01	M02	S01	S02	S03	H01	H02	O01	O02	80 - 81
-----	-----	-----	-----	-----	-----	-----	-----	-----	-----	-----	-----	-----	-----	-----	-----	-----	---------

Note: These recommended cutting data indicators are just for reference. They should be adjusted according to the different cutting condition



AL SE Single Flute Endmills, 1 Flute - 788, 924

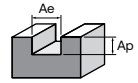

Slotting	N				O			
Working Material	Wrought Aluminium		Cast Aluminium		Copper alloy		Thermoplastic	
Properties	Si < 9%		Si ≥ 9%		-		-	
Cutting depth, ap	1.00 x D		1.00 x D		1.00 x D		1.00 x D	
Cutting Width, ae	1.00 x D		1.00 x D		1.00 x D		1.00 x D	
D	Vc	Fz	Vc	Fz	Vc	Fz	Vc	Fz
2	290	0.022	250	0.018	160	0.013	270	0.020
3		0.038		0.032		0.023		0.035
4		0.063		0.053		0.039		0.058
5		0.081		0.069		0.051		0.076
6		0.101		0.087		0.064		0.095
8		0.139		0.121		0.088		0.129
10		0.179		0.157		0.114		0.166
12		0.221		0.196		0.142		0.210

AL SE Single Flute Endmills, 1 Flute - 788, 924

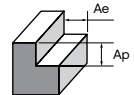

Side Milling	N				O			
Working Material	Wrought Aluminium		Cast Aluminium		Copper alloy		Thermoplastic	
Properties	Si < 9%		Si ≥ 9%		-		-	
Cutting depth, ap	1.00 x D		1.00 x D		1.00 x D		1.00 x D	
Cutting Width, ae	0.30 x D		0.30 x D		0.30 x D		0.30 x D	
D	Vc	Fz	Vc	Fz	Vc	Fz	Vc	Fz
2	340	0.028	300	0.021	210	0.015	320	0.023
3		0.045		0.036		0.027		0.041
4		0.076		0.061		0.045		0.068
5		0.097		0.079		0.060		0.088
6		0.119		0.097		0.076		0.109
8		0.163		0.134		0.108		0.149
10		0.208		0.173		0.142		0.192
12		0.255		0.214		0.180		0.235

AL SE Endmills, 2 Flutes - 301, G49, G52, G53, G71

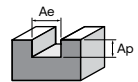

Slotting	N				O			
Working Material	Wrought Aluminium		Cast Aluminium		Copper alloy		Thermoplastic	
Properties	Si < 9%		Si ≥ 9%		-		-	
Cutting depth, ap	1.00 x D		1.00 x D		1.00 x D		1.00 x D	
Cutting Width, ae	1.00 x D		1.00 x D		1.00 x D		1.00 x D	
D	Vc	Fz	Vc	Fz	Vc	Fz	Vc	Fz
1	310	0.010	270	0.008	180	0.004	290	0.009
2		0.012		0.011		0.008		0.011
3		0.021		0.019		0.015		0.019
4		0.035		0.031		0.024		0.031
5		0.045		0.040		0.031		0.041
6		0.056		0.049		0.038		0.051
8		0.077		0.067		0.052		0.070
10		0.098		0.085		0.067		0.091
12		0.122		0.105		0.084		0.113
14		0.138		0.120		0.095		0.128
16		0.154		0.134		0.106		0.142
18		0.169		0.148		0.116		0.155
20		0.183		0.160		0.126		0.166

ALU LINE
EZ LINE - ENDMILL
SE 30
NITCO 30
OPTIMUM
SE 45
SE 45X
NITCO 45
SE 60
SE 60X
DN70 - SE 70
SE GR
TE 45
PLUNGE -MILL
THREAD MILL

Note: These recommended cutting data indicators are just for reference. They should be adjusted according to the different cutting condition



AL SE Endmills, 2 Flutes - 301, G49, G52, G53, G71

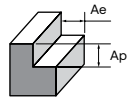

Side Milling	N						O	
Working Material	Wrought Aluminium		Cast Aluminium		Copper alloy		Thermoplastic	
Properties	Si < 9%		Si ≥ 9%		-		-	
Cutting depth, ap	1.00 x D		1.00 x D		1.00 x D		1.00 x D	
Cutting Width, ae	0.30 x D		0.30 x D		0.30 x D		0.30 x D	
D	Vc	Fz	Vc	Fz	Vc	Fz	Vc	Fz
1	360	0.014	320	0.010	230	0.006	340	0.012
2		0.016		0.012		0.010		0.013
3		0.025		0.021		0.018		0.022
4		0.041		0.035		0.030		0.037
5		0.052		0.045		0.039		0.048
6		0.064		0.056		0.049		0.059
8		0.087		0.076		0.068		0.081
10		0.111		0.098		0.088		0.104
12		0.136		0.121		0.111		0.128
14		0.156		0.138		0.124		0.147
16		0.175		0.153		0.136		0.166
18		0.192		0.168		0.147		0.181
20		0.209		0.182		0.157		0.197

AL SE Long Endmills , 2 Flutes - G56, G57

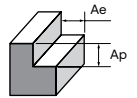

Side Milling	N						O	
Working Material	Wrought Aluminium		Cast Aluminium		Copper alloy		Thermoplastic	
Properties	Si < 9%		Si ≥ 9%		-		-	
Cutting depth, ap	1.50 x D		1.50 x D		1.50 x D		1.50 x D	
Cutting Width, ae	0.25 x D		0.25 x D		0.25 x D		0.25 x D	
D	Vc	Fz	Vc	Fz	Vc	Fz	Vc	Fz
6	330	0.061	290	0.052	200	0.049	310	0.055
8		0.083		0.071		0.066		0.076
10		0.107		0.092		0.084		0.098
12		0.131		0.114		0.104		0.123
14		0.150		0.129		0.119		0.138
16		0.168		0.143		0.133		0.154
20		0.205		0.174		0.164		0.188

ALU LINE
 EZ LINE - ENDMILL
 SE 30
 NITCo 30
 OPTIMUM
 SE 45
 SE 45X
 NITCo 45
 SE 60
 SE 60X
 DM70 - SE70
 SE GR
 TE 45
 PLUNGE -MILL
 THREAD MILL

Note: These recommended cutting data indicators are just for reference. They should be adjusted according to the different cutting condition



AL SE Endmills, 3 Flutes - 303, G50, G69, G70, K30, K31

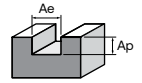

Slotting	N				O			
Working Material	Wrought Aluminium		Cast Aluminium		Copper alloy		Thermoplastic	
Properties	Si < 9%		Si ≥ 9%		-		-	
Cutting depth, ap	1.00 x D		1.00 x D		1.00 x D		1.00 x D	
Cutting Width, ae	1.00 x D		1.00 x D		1.00 x D		1.00 x D	
D	Vc	Fz	Vc	Fz	Vc	Fz	Vc	Fz
1	330	0.008	290	0.006	200	0.003	310	0.007
2		0.010		0.008		0.006		0.009
3		0.016		0.014		0.010		0.015
4		0.026		0.022		0.017		0.024
5		0.033		0.029		0.023		0.031
6		0.041		0.036		0.029		0.038
8		0.056		0.049		0.040		0.052
10		0.071		0.063		0.053		0.067
12		0.088		0.078		0.067		0.084
14		0.100		0.089		0.075		0.095
16		0.112		0.098		0.083		0.106
18		0.123		0.107		0.089		0.116
20	0.133	0.116	0.094	0.125				

AL SE Endmills, 3 Flutes - 303, G50, G69, G70, K30, K31

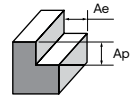

Side Milling	N				O			
Working Material	Wrought Aluminium		Cast Aluminium		Copper alloy		Thermoplastic	
Properties	Si < 9%		Si ≥ 9%		-		-	
Cutting depth, ap	1.00 x D		1.00 x D		1.00 x D		1.00 x D	
Cutting Width, ae	0.30 x D		0.30 x D		0.30 x D		0.30 x D	
D	Vc	Fz	Vc	Fz	Vc	Fz	Vc	Fz
1	380	0.011	340	0.009	250	0.006	360	0.010
2		0.013		0.010		0.008		0.010
3		0.018		0.016		0.014		0.017
4		0.030		0.027		0.022		0.028
5		0.038		0.035		0.029		0.036
6		0.047		0.042		0.036		0.045
8		0.064		0.058		0.050		0.061
10		0.081		0.074		0.064		0.078
12		0.099		0.091		0.080		0.096
14		0.114		0.103		0.091		0.110
16		0.128		0.116		0.101		0.123
18		0.141		0.128		0.109		0.135
20	0.154	0.139	0.117	0.147				

ALU LINE
EZ LINE - ENDMILL
SE 30
NITICO 30
OPTIMUM
SE 45
SE 45X
NITICO 45
SE 60
SE 60X
DN70 - SE70
SE GR
TE 45
PLUNGE -MILL
THREAD MILL

Note: These recommended cutting data indicators are just for reference. They should be adjusted according to the different cutting condition



AL SE Long Endmills , 3 Flutes - G51

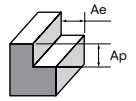

Side Milling	N						O	
Working Material	Wrought Aluminium		Cast Aluminium		Copper alloy		Thermoplastic	
Properties	Si < 9%		Si ≥ 9%		-		-	
Cutting depth, ap	1.00 x D		1.00 x D		1.00 x D		1.00 x D	
Cutting Width, ae	0.30 x D		0.30 x D		0.30 x D		0.30 x D	
D	Vc	Fz	Vc	Fz	Vc	Fz	Vc	Fz
3	305	0.015	270	0.013	200	0.011	285	0.014
4		0.024		0.021		0.018		0.022
5		0.031		0.028		0.024		0.029
6		0.038		0.034		0.029		0.035
8		0.051		0.047		0.040		0.048
10		0.065		0.059		0.052		0.062
12		0.080		0.073		0.065		0.077
14		0.092		0.083		0.073		0.088

AL SE Endmills, 4 Flutes - C45, C51, S42

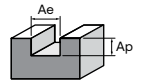

Slotting	N						O	
Working Material	Wrought Aluminium		Cast Aluminium		Copper alloy		Thermoplastic	
Properties	Si < 9%		Si ≥ 9%		-		-	
Cutting depth, ap	1.00 x D		1.00 x D		1.00 x D		1.00 x D	
Cutting Width, ae	1.00 x D		1.00 x D		1.00 x D		1.00 x D	
D	Vc	Fz	Vc	Fz	Vc	Fz	Vc	Fz
3	350	0.013	310	0.012	220	0.010	330	0.012
4		0.022		0.020		0.016		0.020
5		0.028		0.025		0.021		0.026
6		0.034		0.031		0.027		0.032
8		0.047		0.042		0.037		0.044
10		0.059		0.054		0.048		0.057
12		0.073		0.067		0.060		0.071
14		0.084		0.076		0.068		0.081
16		0.094		0.085		0.074		0.090
20		0.112		0.101		0.086		0.108

AL SE Endmills, 4 Flutes - C45, C51, S42

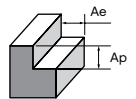

Side Milling	N						O	
Working Material	Wrought Aluminium		Cast Aluminium		Copper alloy		Thermoplastic	
Properties	Si < 9%		Si ≥ 9%		-		-	
Cutting depth, ap	1.00 x D		1.00 x D		1.00 x D		1.00 x D	
Cutting Width, ae	0.30 x D		0.30 x D		0.30 x D		0.30 x D	
D	Vc	Fz	Vc	Fz	Vc	Fz	Vc	Fz
3	400	0.014	360	0.013	260	0.011	380	0.013
4		0.024		0.021		0.019		0.022
5		0.031		0.027		0.025		0.028
6		0.038		0.033		0.031		0.035
8		0.051		0.046		0.043		0.048
10		0.065		0.059		0.055		0.062
12		0.080		0.073		0.069		0.077
14		0.092		0.084		0.078		0.088
16		0.104		0.094		0.086		0.099
20		0.128		0.115		0.104		0.121

ALU LINE
 EZ LINE - ENDMILL
 SE 30
 NITCo 30
 OPTIMUM
 SE 45
 SE 45X
 NITCo 45
 SE 60
 SE 60X
 DM70 - SE70
 SE GR
 TE 45
 PLUNGE -MILL
 THREAD MILL

Note: These recommended cutting data indicators are just for reference. They should be adjusted according to the different cutting condition



AL SE DP Torus Roughing Endmills, 3 Flutes - G72, G73

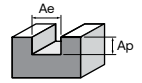

Slotting	N				O			
Working Material	Wrought Aluminium		Cast Aluminium		Copper alloy		Thermoplastic	
Properties	Si < 9%		Si ≥ 9%		-		-	
Cutting depth, ap	1.00 x D		1.00 x D		1.00 x D		1.00 x D	
Cutting Width, ae	1.00 x D		1.00 x D		1.00 x D		1.00 x D	
D	Vc	Fz	Vc	Fz	Vc	Fz	Vc	Fz
6	330	0.045	290	0.040	200	0.032	310	0.042
8		0.061		0.055		0.045		0.057
10		0.077		0.070		0.059		0.073
12		0.095		0.087		0.074		0.090
16		0.120		0.108		0.089		0.111
20		0.142		0.126		0.098		0.129

AL SE DP Torus Roughing Endmills, 3 Flutes - G72, G73

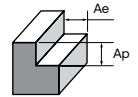

Side Milling	N				O			
Working Material	Wrought Aluminium		Cast Aluminium		Copper alloy		Thermoplastic	
Properties	Si < 9%		Si ≥ 9%		-		-	
Cutting depth, ap	1.00 x D		1.00 x D		1.00 x D		1.00 x D	
Cutting Width, ae	0.30 x D		0.30 x D		0.30 x D		0.30 x D	
D	Vc	Fz	Vc	Fz	Vc	Fz	Vc	Fz
6	380	0.052	340	0.047	250	0.040	360	0.049
8		0.070		0.064		0.055		0.066
10		0.089		0.081		0.071		0.084
12		0.109		0.100		0.088		0.103
16		0.140		0.126		0.110		0.130
20		0.168		0.151		0.128		0.155

XQ ALU CUTTERS DP/DH/DF ENDMILLS, 4 Flutes - K60, K61, K62, K63

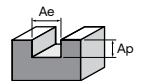

Slotting	N				O			
Working Material	Wrought Aluminium		Cast Aluminium		Copper alloy		Thermoplastic	
Properties	Si < 9%		Si ≥ 9%		-		-	
Cutting depth, ap	1.00 x D		1.00 x D		1.00 x D		1.00 x D	
Cutting Width, ae	1.00 x D		1.00 x D		0.30 x D		1.00 x D	
D	Vc	Fz	Vc	Fz	Vc	Fz	Vc	Fz
6	650	0.034	550	0.027	400	0.023	600	0.030
8		0.046		0.037		0.032		0.040
10		0.059		0.048		0.042		0.051
12		0.073		0.060		0.054		0.063
14		0.083		0.068		0.060		0.071
16		0.093		0.075		0.065		0.078
18		0.102		0.081		0.069		0.084
20		0.111		0.087		0.073		0.090

ALU LINE
EZ LINE - ENDMILL
SE 30
NITCO 30
OPTIMUM
SE 45
SE 45X
NITCO 45
SE 60
SE 60X
DN70 - SE70
SE GR
TE 45
PLUNGE -MILL
THREAD MILL

Recommended Cutting Data



Note: These recommended cutting data indicators are just for reference. They should be adjusted according to the different cutting condition



XQ ALU CUTTERS DP/DH/DF ENDMILLS, 4 Flutes - K60, K61, K62, K63

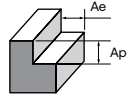

Side Milling	N						O					
Working Material	Wrought Aluminium			Cast Aluminium			Copper alloy			Thermoplastic		
Properties	Si < 9%			Si ≥ 9%			-			-		
Cutting depth, ap	1.00 x D			1.00 x D			1.00 x D			1.00 x D		
Cutting Width, ae	0.30 x D			0.30 x D			0.30 x D			0.30 x D		
D	Vc	Fz		Vc	Fz		Vc	Fz		Vc	Fz	
6	750	0.039		700	0.030		500	0.025		720	0.033	
8		0.053			0.042			0.034			0.045	
10		0.067			0.054			0.045			0.057	
12		0.082			0.067			0.057			0.070	
14		0.094			0.077			0.063			0.080	
16		0.105			0.086			0.069			0.089	
18		0.116			0.094			0.075			0.097	
20		0.126			0.102			0.080			0.105	

AL SE Miniature Endmills With Long Neck, 2 Flutes - G68

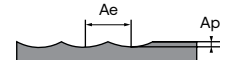

Profiling	N									O			
Working Material	Wrought Aluminium			Cast Aluminium			Copper alloy			Thermoplastic			
Properties	Si < 9%			Si ≥ 9%			-			-			
D	Effective Length	Ap	Vc	Fz	Ap	Vc	Fz	Ap	Vc	Fz	Ap	Vc	Fz
0.2	0.5	0.100	25	0.008		23	0.008	0.100	25	0.008	0.100	24	0.008
	1.0	0.040	24	0.007	0.040	21	0.007	0.040	22	0.007	0.040	22	0.007
	1.5	0.028	22	0.007	0.028	20	0.007	0.028	21	0.007	0.028	21	0.007
0.3	1.0	0.100	38	0.010	0.100	34	0.010	0.100	36	0.011	0.100	36	0.010
	2.0	0.050	33	0.009	0.050	30	0.009	0.050	32	0.009	0.050	31	0.009
	3.0	0.030	28	0.007	0.030	25	0.008	0.030	27	0.008	0.030	26	0.007
0.4	2.0	0.080	47	0.011	0.080	42	0.011	0.080	45	0.012	0.080	45	0.011
	3.0	0.058	44	0.010	0.058	39	0.011	0.058	42	0.012	0.058	42	0.010
	4.0	0.040	37	0.009	0.040	33	0.009	0.040	35	0.009	0.040	35	0.009
0.5	5.0	0.033	34	0.008	0.033	31	0.008	0.033	33	0.008	0.033	32	0.008
	2.0	0.125	63	0.014	0.125	57	0.014	0.125	61	0.015	0.125	60	0.014
	4.0	0.063	51	0.011	0.063	46	0.011	0.063	49	0.012	0.063	48	0.011
0.6	6.0	0.043	42	0.009	0.043	38	0.009	0.043	41	0.009	0.043	40	0.009
	8.0	0.033	34	0.008	0.033	31	0.008	0.033	33	0.008	0.033	33	0.007
	2.0	0.200	75	0.017	0.200	68	0.017	0.200	73	0.018	0.200	72	0.017
0.7	4.0	0.100	66	0.015	0.100	59	0.015	0.100	63	0.016	0.100	62	0.015
	6.0	0.060	56	0.013	0.060	50	0.013	0.060	54	0.014	0.060	53	0.013
	8.0	0.045	51	0.011	0.045	46	0.012	0.045	49	0.013	0.045	48	0.011
0.8	10.0	0.038	41	0.009	0.038	37	0.009	0.038	40	0.009	0.038	39	0.009
	2.0	0.350	88	0.019	0.350	79	0.019	0.350	85	0.020	0.350	84	0.019
	4.0	0.140	82	0.018	0.140	74	0.018	0.140	79	0.019	0.140	78	0.018
0.9	6.0	0.088	71	0.015	0.088	64	0.015	0.088	68	0.016	0.088	67	0.015
	8.0	0.063	65	0.014	0.063	59	0.014	0.063	63	0.015	0.063	62	0.014
	10.0	0.050	54	0.012	0.050	48	0.012	0.050	51	0.013	0.050	51	0.012
0.8	4.0	0.160	94	0.020	0.160	85	0.020	0.160	91	0.021	0.160	89	0.020
	6.0	0.115	87	0.018	0.115	79	0.018	0.115	85	0.019	0.115	83	0.018
	8.0	0.080	74	0.016	0.080	67	0.016	0.080	72	0.017	0.080	71	0.015
0.9	10.0	0.068	68	0.014	0.068	61	0.014	0.068	65	0.015	0.068	65	0.014
	12.0	0.053	61	0.013	0.053	55	0.013	0.053	59	0.014	0.053	58	0.013
	6.0	0.150	98	0.020	0.150	89	0.020	0.150	95	0.021	0.150	94	0.020
0.9	8.0	0.113	91	0.018	0.113	82	0.018	0.113	88	0.019	0.113	87	0.018
	10.0	0.083	84	0.017	0.083	75	0.017	0.083	80	0.018	0.083	79	0.017
	15.0	0.058	62	0.013	0.058	55	0.013	0.058	59	0.014	0.058	59	0.013

cont'd ▶

ALU LINE
EZ LINE - ENDMILL
SE 30
NITCo 30
OPTIMUM
SE 45
SE 45X
NITCo 45
SE 60
SE 60X
DM70 - SE70
SE GR
TE 45
PLUNGE -MILL
THREAD MILL

Note: These recommended cutting data indicators are just for reference. They should be adjusted according to the different cutting condition



AL SE Miniature Endmills With Long Neck, 2 Flutes - G68

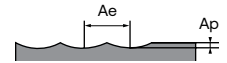

Profiling		N									O		
Working Material		Wrought Aluminium			Cast Aluminium			Copper alloy			Thermoplastic		
Properties		Si < 9%			Si ≥ 9%			-			-		
D	Effective Length	Ap	Vc	Fz	Ap	Vc	Fz	Ap	Vc	Fz	Ap	Vc	Fz
1	6.0	0.168	109	0.022	0.168	98	0.022	0.168	105	0.023	0.168	104	0.022
	8.0	0.125	101	0.020	0.125	91	0.020	0.125	97	0.021	0.125	96	0.020
	10.0	0.100	93	0.019	0.100	84	0.019	0.100	90	0.020	0.100	88	0.019
	12.0	0.083	85	0.017	0.083	76	0.017	0.083	81	0.018	0.083	81	0.017
	14.0	0.073	77	0.015	0.073	69	0.015	0.073	74	0.016	0.073	73	0.015
1.2	6.0	0.240	141	0.028	0.240	127	0.028	0.240	136	0.029	0.240	134	0.028
	8.0	0.200	131	0.026	0.200	118	0.026	0.200	126	0.027	0.200	125	0.026
	10.0	0.150	121	0.024	0.150	109	0.024	0.150	117	0.025	0.150	115	0.024
	12.0	0.120	112	0.022	0.120	100	0.022	0.120	107	0.023	0.120	106	0.022
1.4	6.0	0.350	176	0.034	0.350	158	0.034	0.350	169	0.036	0.350	167	0.034
	8.0	0.280	165	0.032	0.280	148	0.032	0.280	158	0.034	0.280	156	0.032
	10.0	0.200	153	0.030	0.200	138	0.030	0.200	148	0.032	0.200	146	0.030
	12.0	0.175	142	0.027	0.175	128	0.027	0.175	137	0.028	0.175	135	0.027
	14.0	0.140	130	0.025	0.140	117	0.025	0.140	125	0.026	0.140	124	0.025
1.5	6.0	0.375	189	0.036	0.375	170	0.036	0.375	182	0.038	0.375	179	0.036
	8.0	0.300	176	0.034	0.300	159	0.034	0.300	170	0.036	0.300	167	0.034
	10.0	0.250	164	0.031	0.250	148	0.031	0.250	158	0.033	0.250	156	0.031
	12.0	0.188	152	0.029	0.188	137	0.029	0.188	147	0.030	0.188	144	0.029
	14.0	0.168	152	0.029	0.168	137	0.029	0.168	147	0.030	0.168	144	0.029
	16.0	0.150	140	0.027	0.150	125	0.027	0.150	134	0.028	0.150	132	0.027
	18.0	0.125	127	0.024	0.125	115	0.024	0.125	123	0.025	0.125	121	0.024
1.6	6.0	0.533	201	0.038	0.533	181	0.038	0.533	194	0.040	0.533	191	0.038
	8.0	0.320	188	0.036	0.320	169	0.035	0.320	181	0.037	0.320	178	0.036
	10.0	0.268	175	0.033	0.268	157	0.033	0.268	168	0.035	0.268	166	0.033
	12.0	0.228	175	0.033	0.228	157	0.033	0.228	168	0.035	0.228	166	0.033
	14.0	0.200	162	0.031	0.200	146	0.031	0.200	156	0.033	0.200	154	0.031
	16.0	0.160	149	0.028	0.160	134	0.028	0.160	143	0.029	0.160	141	0.028
	18.0	0.145	149	0.028	0.145	134	0.028	0.145	143	0.029	0.145	141	0.028
1.8	6.0	0.600	226	0.043	0.600	204	0.043	0.600	218	0.045	0.600	215	0.043
	8.0	0.450	226	0.043	0.450	204	0.043	0.450	218	0.045	0.450	215	0.043
	10.0	0.360	212	0.040	0.360	191	0.040	0.360	204	0.042	0.360	201	0.040
	12.0	0.300	197	0.037	0.300	177	0.037	0.300	189	0.039	0.300	187	0.037
	14.0	0.258	197	0.037	0.258	177	0.037	0.258	189	0.039	0.258	187	0.037
	16.0	0.225	182	0.035	0.225	164	0.035	0.225	175	0.037	0.225	173	0.035
	18.0	0.180	167	0.032	0.180	150	0.032	0.180	161	0.034	0.180	159	0.032
2	6.0	0.668	251	0.047	0.668	226	0.047	0.668	242	0.049	0.668	239	0.047
	8.0	0.500	251	0.047	0.500	226	0.047	0.500	242	0.049	0.500	239	0.047
	10.0	0.400	235	0.044	0.400	212	0.044	0.400	227	0.046	0.400	223	0.044
	12.0	0.333	219	0.041	0.333	197	0.041	0.333	211	0.043	0.333	208	0.041
	14.0	0.285	219	0.041	0.285	197	0.041	0.285	211	0.043	0.285	208	0.041
	16.0	0.250	202	0.038	0.250	182	0.038	0.250	195	0.040	0.250	192	0.038
	18.0	0.223	202	0.038	0.223	182	0.038	0.223	195	0.040	0.223	192	0.038
	20.0	0.200	186	0.035	0.200	167	0.035	0.200	179	0.037	0.200	177	0.035
	25.0	0.168	170	0.032	0.168	153	0.032	0.168	164	0.034	0.168	161	0.032
30.0	0.133	153	0.029	0.133	138	0.029	0.133	148	0.030	0.133	146	0.029	

cont'd ▶

ALU LINE
EZ LINE - ENDMILL
SE 30
NITCO 30
OPTIMUM
SE 45
SE 45X
NITCO 45
SE 60
SE 60X
DN70 - SE70
SE GR
TE 45
PLUNGE -MILL
THREAD MILL

Note: These recommended cutting data indicators are just for reference. They should be adjusted according to the different cutting condition



AL SE Miniature Endmills With Long Neck, 2 Flutes - G68

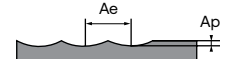

Profiling		N									O		
Working Material		Wrought Aluminium			Cast Aluminium			Copper alloy			Thermoplastic		
Properties		Si < 9%			Si ≥ 9%			-			-		
D	Effective Length	Ap	Vc	Fz	Ap	Vc	Fz	Ap	Vc	Fz	Ap	Vc	Fz
2.5	8.0	0.833	314	0.058	0.833	283	0.058	0.833	303	0.061	0.833	298	0.058
	10.0	0.625	314	0.058	0.625	283	0.058	0.625	303	0.061	0.625	298	0.058
	12.0	0.625	314	0.058	0.625	283	0.058	0.625	303	0.061	0.625	298	0.058
	14.0	0.500	294	0.054	0.500	265	0.054	0.500	284	0.057	0.500	279	0.054
	16.0	0.418	273	0.050	0.418	246	0.050	0.418	263	0.053	0.418	260	0.050
	18.0	0.358	273	0.050	0.358	246	0.050	0.358	263	0.053	0.358	260	0.050
	20.0	0.313	253	0.047	0.313	228	0.047	0.313	244	0.049	0.313	240	0.047
	25.0	0.250	233	0.043	0.250	209	0.043	0.250	224	0.045	0.250	221	0.043
3	8.0	1.500	377	0.068	1.500	339	0.068	1.500	363	0.071	1.500	358	0.068
	10.0	1.000	377	0.068	1.000	339	0.068	1.000	363	0.071	1.000	358	0.068
	12.0	0.750	377	0.068	0.750	339	0.068	0.750	363	0.071	0.750	358	0.068
	14.0	0.750	377	0.068	0.750	339	0.068	0.750	363	0.071	0.750	358	0.068
	16.0	0.600	353	0.064	0.600	318	0.064	0.600	340	0.067	0.600	335	0.064
	18.0	0.500	328	0.059	0.500	295	0.059	0.500	316	0.062	0.500	312	0.059
	20.0	0.500	328	0.059	0.500	295	0.059	0.500	316	0.062	0.500	312	0.059
4	10.0	2.000	450	0.096	2.000	405	0.096	2.000	433	0.101	2.000	427	0.096
	15.0	1.333	450	0.096	1.333	405	0.096	1.333	433	0.101	1.333	427	0.096
	20.0	0.800	421	0.089	0.800	380	0.089	0.800	407	0.093	0.800	400	0.089
	25.0	0.668	392	0.083	0.668	353	0.083	0.668	378	0.087	0.668	372	0.083
	30.0	0.573	392	0.083	0.573	353	0.083	0.573	378	0.087	0.573	372	0.083
	40.0	0.400	333	0.071	0.400	300	0.071	0.400	321	0.075	0.400	317	0.071

AL BN Ballnose Cutters, 2 Flutes - G74, G75

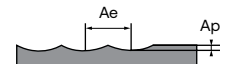

Roughing		N						O	
Working Material		Wrought Aluminium		Cast Aluminium		Copper alloy		Thermoplastic	
Properties		Si < 9%		Si ≥ 9%		-		-	
Cutting depth, ap		0.10 × D		0.10 × D		0.10 × D		0.10 × D	
Cutting Width, ae		0.35 × D		0.35 × D		0.30 × D		0.35 × D	
D	Vc	Fz	Vc	Fz	Vc	Fz	Vc	Fz	
3	450	0.027	400	0.023	350	0.019	380	0.020	
4		0.037		0.032		0.026		0.027	
5		0.048		0.041		0.033		0.035	
6		0.059		0.050		0.041		0.043	
8		0.080		0.069		0.057		0.059	
10		0.102		0.088		0.074		0.076	
12		0.126		0.108		0.092		0.094	
16		0.164		0.141		0.119		0.122	
20		0.202		0.173		0.144		0.149	

ALU LINE
 EZ LINE - ENDMILL
 SE 30
 NITCo 30
 OPTIMUM
 SE 45
 SE 45X
 SE 45X
 NITCo 45
 SE 60
 SE 60X
 DM70 - SE70
 SE GR
 TE 45
 PLUNGE -MILL
 THREAD MILL

Note: These recommended cutting data indicators are just for reference. They should be adjusted according to the different cutting condition



AL BN Ballnose Cutters, 2 Flutes - G74, G75

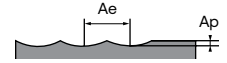

Finishing	N						O	
Working Material	Wrought Aluminium		Cast Aluminium		Copper alloy		Thermoplastic	
Properties	Si < 9%		Si ≥ 9%		-		-	
Cutting depth, ap	0.05 × D		0.05 × D		0.05 × D		0.05 × D	
Cutting Width, ae	0.02 × D		0.02 × D		0.02 × D		0.02 × D	
D	Vc	Fz	Vc	Fz	Vc	Fz	Vc	Fz
3	470	0.021	420	0.018	370	0.014	400	0.015
4		0.028		0.024		0.020		0.021
5		0.037		0.031		0.025		0.027
6		0.045		0.038		0.031		0.033
8		0.061		0.052		0.043		0.045
10		0.078		0.067		0.056		0.058
12		0.097		0.083		0.069		0.072
16		0.126		0.108		0.090		0.093
20		0.155		0.132		0.109		0.113

AL BN Miniature Ballnose Cutters With Long Neck, 2 Flutes - G76

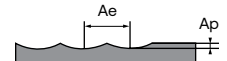

Profiling		N									O		
Working Material		Wrought Aluminium			Cast Aluminium			Copper alloy			Thermoplastic		
Properties		Si < 9%			Si ≥ 9%			-			-		
D	Effective Length	Ap	N	Fz	Ap	N	Fz	Ap	N	Fz	Ap	N	Fz
0.2	0.5	0.029	50000	0.007		50000	0.007	0.024	50000	0.006	0.026	50000	0.006
	1.0	0.020	50000	0.007	0.018	50000	0.007	0.017	50000	0.006	0.018	50000	0.006
	1.5	0.012	50000	0.007	0.011	50000	0.007	0.010	50000	0.006	0.010	50000	0.006
0.3	1.0	0.030	50000	0.007	0.028	50000	0.007	0.025	50000	0.006	0.027	50000	0.006
	2.0	0.017	50000	0.006	0.016	50000	0.006	0.014	50000	0.005	0.016	50000	0.005
	3.0	0.012	50000	0.006	0.011	50000	0.006	0.010	50000	0.005	0.010	50000	0.005
0.4	1.0	0.058	50000	0.011	0.053	50000	0.010	0.048	50000	0.009	0.052	50000	0.010
	2.0	0.040	50000	0.010	0.037	50000	0.009	0.034	50000	0.008	0.036	50000	0.009
	3.0	0.023	50000	0.008	0.021	50000	0.008	0.019	50000	0.007	0.021	50000	0.008
0.5	4.0	0.014	50000	0.007	0.013	50000	0.007	0.012	50000	0.006	0.013	50000	0.006
	5.0	0.012	50000	0.006	0.011	50000	0.006	0.010	50000	0.005	0.010	50000	0.005
	2.0	0.050	50000	0.014	0.046	50000	0.013	0.042	50000	0.012	0.045	50000	0.013
	3.0	0.043	50000	0.013	0.040	50000	0.012	0.036	50000	0.011	0.039	50000	0.012
	4.0	0.029	50000	0.012	0.026	50000	0.011	0.024	50000	0.010	0.026	50000	0.011
	5.0	0.026	50000	0.011	0.024	50000	0.010	0.022	50000	0.009	0.023	50000	0.010
0.6	6.0	0.019	50000	0.010	0.017	50000	0.009	0.016	50000	0.008	0.017	50000	0.009
	8.0	0.012	50000	0.008	0.011	50000	0.008	0.010	50000	0.007	0.010	50000	0.008
	2.0	0.091	50000	0.024	0.083	50000	0.022	0.076	50000	0.020	0.082	50000	0.022
	3.0	0.059	50000	0.022	0.054	50000	0.020	0.049	50000	0.018	0.053	50000	0.019
	4.0	0.037	50000	0.020	0.034	50000	0.019	0.031	50000	0.017	0.034	50000	0.018
	5.0	0.029	50000	0.017	0.026	50000	0.015	0.024	50000	0.014	0.026	50000	0.015
0.8	6.0	0.022	50000	0.016	0.020	50000	0.014	0.018	50000	0.013	0.019	50000	0.014
	8.0	0.022	50000	0.014	0.020	50000	0.013	0.018	50000	0.012	0.019	50000	0.013
	2.0	0.173	50000	0.031	0.158	50000	0.029	0.144	50000	0.026	0.156	50000	0.028
	4.0	0.112	50000	0.030	0.103	50000	0.028	0.094	50000	0.025	0.101	50000	0.027
	5.0	0.085	50000	0.029	0.078	50000	0.026	0.071	50000	0.024	0.076	50000	0.026
	6.0	0.060	50000	0.026	0.055	50000	0.024	0.050	50000	0.022	0.054	50000	0.024
1.0	7.0	0.044	50000	0.023	0.041	50000	0.021	0.037	50000	0.019	0.040	50000	0.021
	8.0	0.029	50000	0.019	0.026	50000	0.018	0.024	49920	0.016	0.026	50000	0.017
	10.0	0.029	50000	0.018	0.026	50000	0.017	0.024	46000	0.015	0.026	49680	0.016
	3.0	0.288	50000	0.032	0.264	50000	0.030	0.240	50000	0.027	0.259	50000	0.029
	4.0	0.202	50000	0.031	0.185	50000	0.029	0.168	50000	0.026	0.181	50000	0.028
	5.0	0.130	50000	0.030	0.119	50000	0.028	0.108	50000	0.025	0.117	50000	0.027
	6.0	0.086	50000	0.029	0.079	50000	0.026	0.072	50000	0.024	0.078	50000	0.026

cont'd ▶

ALU LINE
EZ LINE - ENDMILL
SE 30
NITICO 30
OPTIMUM
SE 45
SE 45X
NITICO 45
SE 60
SE 60X
DN70 - SE 70
SE GR
TE 45
PLUNGE -MILL
THREAD MILL

Note: These recommended cutting data indicators are just for reference. They should be adjusted according to the different cutting condition



AL BN Miniature Ballnose Cutters With Long Neck, 2 Flutes - G76

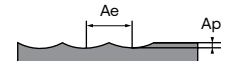

Profiling		N									O		
Working Material		Wrought Aluminium			Cast Aluminium			Copper alloy			Thermoplastic		
Properties		Si < 9%			Si ≥ 9%			-			-		
D	Effective Length	Ap	N	Fz	Ap	N	Fz	Ap	N	Fz	Ap	N	Fz
1.0	7.0	0.086	50000	0.028	0.079	50000	0.025	0.072	46660	0.023	0.078	50000	0.025
	8.0	0.086	50000	0.028	0.079	50000	0.025	0.072	46660	0.023	0.078	50000	0.025
	9.0	0.065	50000	0.026	0.059	50000	0.024	0.054	46660	0.022	0.058	50000	0.024
	10.0	0.055	50000	0.025	0.050	50000	0.023	0.046	46660	0.021	0.049	50000	0.023
	12.0	0.036	41470	0.025	0.033	38020	0.023	0.030	34560	0.021	0.032	37330	0.023
	14.0	0.029	41470	0.025	0.026	38020	0.023	0.024	34560	0.021	0.026	37330	0.023
	16.0	0.022	41470	0.024	0.020	38020	0.022	0.018	34560	0.020	0.019	37330	0.022
1.2	20.0	0.014	31100	0.024	0.013	28510	0.022	0.012	25920	0.020	0.013	27990	0.022
	6.0	0.158	50000	0.034	0.145	49420	0.031	0.132	44930	0.028	0.143	48520	0.030
	8.0	0.086	50000	0.034	0.079	49280	0.031	0.072	44800	0.028	0.078	48380	0.030
	10.0	0.076	49760	0.029	0.070	45620	0.026	0.064	41470	0.024	0.069	44790	0.026
1.4	12.0	0.065	49760	0.028	0.059	45620	0.025	0.054	41470	0.023	0.058	44790	0.025
	8.0	0.158	47170	0.041	0.145	43240	0.037	0.132	39310	0.034	0.143	42460	0.037
	12.0	0.076	43550	0.032	0.070	39920	0.030	0.064	36290	0.027	0.069	39190	0.029
1.5	16.0	0.050	32260	0.030	0.046	29570	0.028	0.042	26880	0.025	0.045	29030	0.027
	8.0	0.173	47170	0.043	0.158	43240	0.040	0.144	39310	0.036	0.156	42460	0.039
	12.0	0.130	43550	0.036	0.119	39920	0.033	0.108	36290	0.030	0.117	39190	0.032
1.6	16.0	0.055	36000	0.034	0.050	33000	0.031	0.046	30000	0.028	0.049	32400	0.030
	18.0	0.055	32260	0.032	0.050	29570	0.030	0.046	26880	0.027	0.049	29030	0.029
	8.0	0.317	50000	0.048	0.290	48050	0.044	0.264	43680	0.040	0.285	47170	0.043
1.8	12.0	0.141	44880	0.038	0.129	41140	0.035	0.118	37400	0.032	0.127	40390	0.035
	16.0	0.086	40440	0.037	0.079	37070	0.034	0.072	33700	0.031	0.078	36400	0.033
	20.0	0.058	29950	0.036	0.053	27460	0.033	0.048	24960	0.030	0.052	26960	0.032
2.0	8.0	0.374	48670	0.058	0.343	44620	0.053	0.312	40560	0.048	0.337	43810	0.052
	12.0	0.151	40440	0.043	0.139	37070	0.040	0.126	33700	0.036	0.136	36400	0.039
	16.0	0.098	38400	0.040	0.090	35200	0.036	0.082	32000	0.033	0.088	34560	0.036
	20.0	0.065	29950	0.040	0.059	27460	0.036	0.054	24960	0.033	0.058	26960	0.036
3.0	4.0	0.576	45360	0.090	0.528	41580	0.083	0.480	37800	0.075	0.518	40820	0.081
	6.0	0.576	45360	0.082	0.528	41580	0.075	0.480	37800	0.068	0.518	40820	0.073
	8.0	0.403	45360	0.082	0.370	41580	0.075	0.336	37800	0.068	0.363	40820	0.073
	10.0	0.302	42340	0.072	0.277	38808	0.066	0.252	35280	0.060	0.272	38100	0.065
	12.0	0.017	38100	0.067	0.016	34930	0.062	0.014	31750	0.056	0.016	34290	0.060
	14.0	0.173	38100	0.067	0.158	34930	0.062	0.144	31750	0.056	0.156	34290	0.060
	16.0	0.173	35380	0.043	0.158	32430	0.040	0.144	29480	0.036	0.156	31840	0.039
	18.0	0.130	32660	0.042	0.119	29940	0.039	0.108	27220	0.035	0.117	29400	0.038
	20.0	0.108	32660	0.042	0.099	29940	0.039	0.090	27220	0.035	0.097	29400	0.038
	22.0	0.072	25700	0.041	0.066	23560	0.037	0.060	21420	0.034	0.065	23130	0.037
4.0	25.0	0.072	24190	0.040	0.066	22180	0.036	0.060	20160	0.033	0.065	21770	0.036
	30.0	0.043	24190	0.040	0.040	22180	0.036	0.036	20160	0.033	0.039	21770	0.036
	8.0	0.720	32160	0.134	0.660	29480	0.123	0.600	26800	0.112	0.648	28940	0.121
	10.0	0.605	31800	0.134	0.554	29150	0.123	0.504	26500	0.112	0.544	28620	0.121
	16.0	0.454	31440	0.097	0.416	28820	0.089	0.378	26200	0.081	0.408	28300	0.087
	20.0	0.259	26950	0.080	0.238	24710	0.074	0.216	22460	0.067	0.233	24260	0.072
	25.0	0.173	25440	0.080	0.158	23320	0.074	0.144	21200	0.067	0.156	22900	0.072
4.0	30.0	0.173	23400	0.079	0.158	21450	0.073	0.144	19500	0.066	0.156	21060	0.071
	35.0	0.115	18430	0.077	0.106	16900	0.070	0.096	15360	0.064	0.104	16590	0.069
	10.0	0.720	24840	0.180	0.660	22770	0.165	0.600	20700	0.150	0.648	22360	0.162
	16.0	0.605	24840	0.180	0.554	22770	0.165	0.504	20700	0.150	0.544	22360	0.162
	20.0	0.454	21530	0.144	0.416	19730	0.132	0.378	17940	0.120	0.408	19380	0.130
	25.0	0.346	19380	0.130	0.317	17770	0.119	0.288	16150	0.108	0.311	17440	0.117
	30.0	0.230	17880	0.107	0.211	16390	0.098	0.192	14900	0.089	0.207	16090	0.096
	35.0	0.173	17880	0.107	0.158	16390	0.098	0.144	14900	0.089	0.156	16090	0.096
4.0	40.0	0.144	17880	0.107	0.132	16390	0.098	0.120	14900	0.089	0.130	16090	0.096
	45.0	0.115	13250	0.102	0.106	12144	0.094	0.096	11040	0.085	0.104	11920	0.092
	50.0	0.115	13250	0.102	0.106	12144	0.094	0.096	11040	0.085	0.104	11920	0.092

Note: These recommended cutting data indicators are just for reference. They should be adjusted according to the different cutting condition



XQ DP/DH/DF Long Endmills, with internal coolant, 4 Flutes - K88

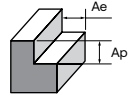

Side Milling	N				O			
Working Material	Wrought Aluminium		Cast Aluminium		Copper alloy		Thermoplastic	
Properties	Si < 9%		Si ≥ 9%		-		-	
Cutting depth, ap	1.50 × D		1.50 × D		1.50 × D		1.50 × D	
Cutting Width, ae	0.20 × D		0.20 × D		0.20 × D		0.20 × D	
D	Vc	Fz	Vc	Fz	Vc	Fz	Vc	Fz
6	600	0.031	560	0.026	400	0.024	580	0.030
8		0.044		0.037		0.035		0.041
10		0.060		0.048		0.047		0.053
12		0.077		0.061		0.059		0.066
16		0.085		0.069		0.065		0.074
20		0.092		0.076		0.069		0.080

XQ DP/DH/DF Long Endmills, with internal coolant and chip breaker, 4 Flutes - K89

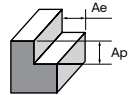

Side Milling	N				O			
Working Material	Wrought Aluminium		Cast Aluminium		Copper alloy		Thermoplastic	
Properties	Si < 9%		Si ≥ 9%		-		-	
Cutting depth, ap	2.00 × D		2.00 × D		2.00 × D		2.00 × D	
Cutting Width, ae	0.20 × D		0.20 × D		0.20 × D		0.20 × D	
D	Vc	Fz	Vc	Fz	Vc	Fz	Vc	Fz
6	600	0.028	560	0.024	400	0.022	580	0.027
8		0.040		0.034		0.032		0.037
10		0.054		0.044		0.042		0.048
12		0.070		0.056		0.054		0.060
16		0.078		0.063		0.059		0.067
20		0.085		0.069		0.063		0.073

ALU LINE
EZ LINE - ENDMILL
SE 30
NITCO 30
OPTIMUM
SE 45
SE 45X
NITCO 45
SE 60
SE 60X
DM70 - SE 70
SE GR
TE 45
PLUNGE -MILL
THREAD MILL

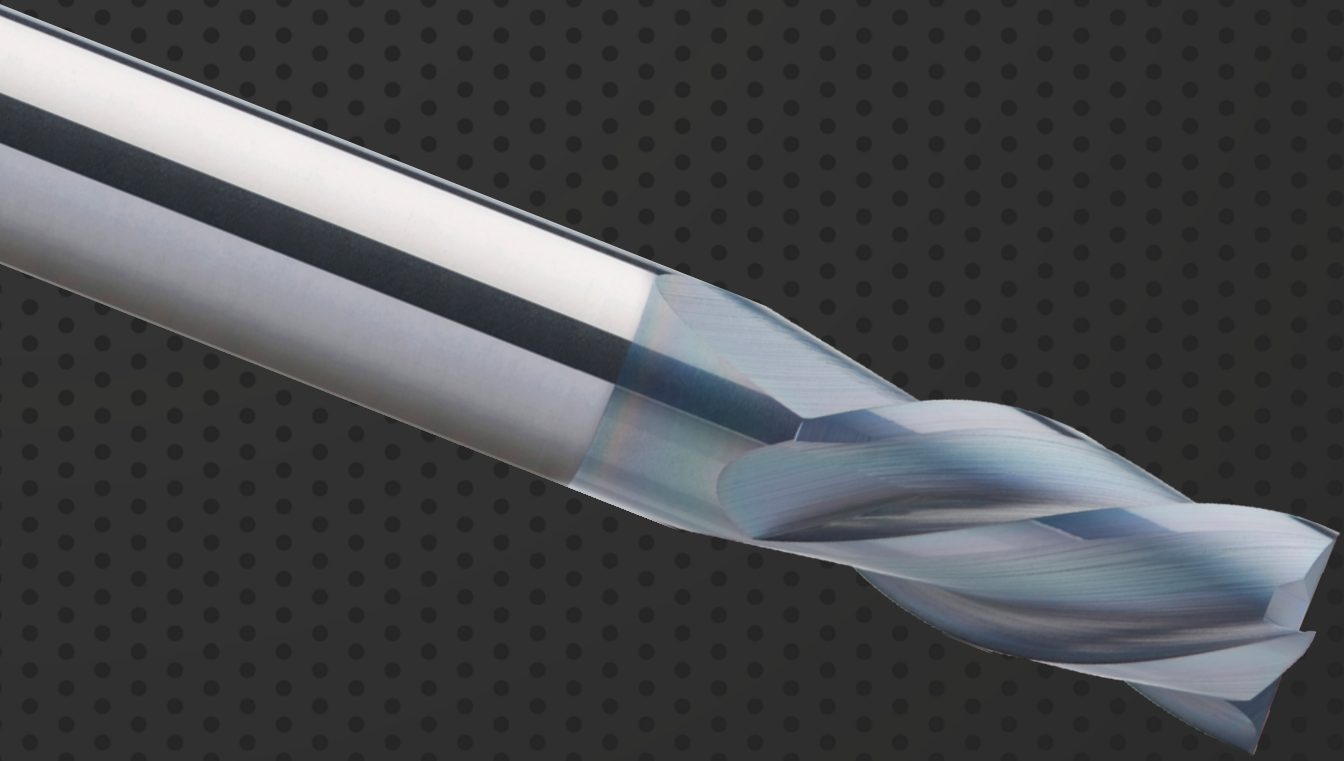

ENDMILLS

EZ LINE - ENDMILL

For material P, M, K, N application ≤ 35 HRC

Index EZ LINE - ENDMILL, For ≤ 35 HRC

Suitable for Material Groups
 Adapté pour les matériaux
 适用于材料
 Geeignet für die Materialgruppen
 Adatto per il materiale

P
M
K
N

	EDP Number	Type	No. Z	Helix Angle	Coating	Performance	Page Number
NEW	C76 	EZ DP/DH	4	$a^\circ \neq b^\circ$	G610	G	87

G - General P - Performance

FEATURES & BENEFITS

EZ Line - Endmill



Top View

1 Gash Land Design



Significantly improves strength and provide great chipping resistance

2 Eccentric Grinding

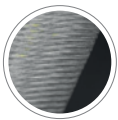

Optimum eccentric grinding in order to avoid rubbing, while maintaining maximum cutting tool strength.

3 Differential Pitch (DP)



- Provides excellent surface finishing while eliminating chatter
- For chatter free machining and excellent surface finish



4 Differential Helix (DH)



- Reduces machining vibrations allowing for high speed machining and increased productivity
- For chatter free machining and excellent surface finishing

5 Suitable for Material Groups





1. Stirnschliff Design
Verbessert die Leistung deutlich und bietet Schutz gegen Ausbrüche
2. Exzentrischer Schliff
Optimaler exzentrischer Schliff zur Reduzierung der Reibung unter Beibehaltung der maximalen Schneidenstabilität
3. Ungleiche Teilung (DP)
Per una lavorazione senza vibrazione e finiture superficiali eccellenti
4. Ungleiche Drallsteigung (DH)
Reduziert Bearbeitungsvibrationen und ermöglicht eine Hochgeschwindigkeitsbearbeitung und eine höhere Produktivität
Zur Schnittkraftreduzierung und Leistungssteigerung
5. Geeignet für Materialgruppen P, M, K, N



1. 底刃斜面式设计
显著提高强度, 提供极好的耐崩裂性。
2. 偏心研磨
最佳偏心研磨, 可避免摩擦, 同时保持最大切削刀具强度。
3. 不等分割设计 (DP)
有效降低加工时的振动从而, 达到更好的工件表面光洁度。
4. 不等螺旋角设计 (DH)
减少加工振动, 有效提升, 加工速度并提高生产率。
用于无颤振加工和出色的表面光洁度。
5. 适用于材料 P、M、K、N



1. Struttura area sgrossatura
Migliora notevolmente la potenza e offre un'eccellente resistenza alle scheggiature
2. Levigatura orbitale
Levigatura orbitale ottimale per evitare sfregatura, garantendo la massima resistenza dello strumento di taglio.
3. Design del passo differenziale (DP)
Design del passo differenziale (DP) Riduce le vibrazioni, massimizza la produttività e la durata dell'utensile.
4. Elica differenziale (DH)
Riduce le vibrazioni di lavorazione, consentendo di lavorazioni ad alta velocità e maggiore produttività
Per ridurre le forze di taglio e migliorare le performance di lavorazione
5. Adatto per il materiale P, M, K, N



1. Conception de fraise pour l'usinage general
Améliore considérablement la solidité et apporte une excellente résistance à l'ébarbage
2. Meulage excentrique
Meulage optimal diminuant le coefficient de friction tout en maintenant une bonne acuité de l'arête de coupe
3. Conception à pas différentiel (DP)
Pour un usinage sans vibrations et un très bon état de surface
4. Conception à hélice variable (DH)
Réduit les efforts de coupes et améliore les performances d'usinage
Pour un usinage sans bavardage et un excellent état de surface
5. Adapté pour les matériaux P, M, K, N

EZ DP/DH Endmills, 4 flutes

- VHM EZ DP/DH Standard Fräser, 4 Zähne
- Frese EZ , con passo differenziale, elica variabile, 4 taglienti
- Fraises EZ DP/DH standard - 4 dents
- 整体硬质合金 EZ DP/DH 系列 4刃平底铣刀

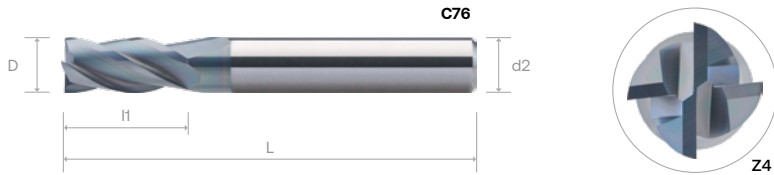
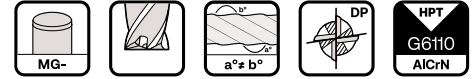

Order Number	Dimension (mm)					G6110
	D	l1	l2	L	d2 (h6)	
C76 0100 040 03	1	3		40	3	•
C76 0150 040 03	1.5	4.5		40	3	•
C76 0200 040 03	2	6.5		40	3	•
C76 0250 040 03	2.5			40	3	•
C76 0300	3	9		40	3	•
C76 0400	4	12		50	4	•
C76 0500	5	15		50	5	•
C76 0600 060	6	16		60	6	•
C76 0800	8	20		64	8	•
C76 1000	10	22		75	10	•
C76 1200	12	25		75	12	•
C76 1400	14	32		90	14	•
C76 1600	16			90	16	•
C76 1800	18	38		100	18	•
C76 2000	20			100	20	•
C76 2500	25	40		100	25	◦

Material Group | Material-Gruppe | Groupe Matière | Gruppo Materiali | 材质主类

Cutting Parameter

N01	N02	N03	K01	K02	P01	P02	P03	M01	M02	S01	S02	S03	H01	H02	O01	O02	88
○	○	○	○	○	○	○	○	○	○	○	○	○	○	○	○	○	

ALU LINE
 EZ LINE - ENDMILL
 SE 30
 NITCo 30
 OPTIMUM
 SE 45
 SE 45X
 NITCo 45
 SE 60
 SE 60X
 DM70 - SE70
 SE GR
 TE 45
 PLUNGE -MILL
 THREAD MILL

Note: These recommended cutting data indicators are just for reference. They should be adjusted according to the different cutting condition



EZ DP/DH Endmills, 4 Flutes - C76

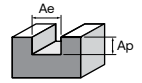

Slotting	N				K		P				M			
Working Material	Wrought Aluminium		Cast Aluminium		Copper alloy		Grey Cast Iron		Carbon steel		Alloy steel		Stainless steel	
Properties	Si < 9%		Si ≥ 9%		-		-		-		520 < Rm < 1200		High Machinability	
Cutting depth, ap	1.00 x D		1.00 x D		1.00 x D		1.00 x D		1.00 x D		1.00 x D		0.80 x D	
Cutting Width, ae	1.00 x D		1.00 x D		1.00 x D		1.00 x D		1.00 x D		1.00 x D		1.00 x D	
D	Vc	Fz	Vc	Fz	Vc	Fz	Vc	Fz	Vc	Fz	Vc	Fz	Vc	Fz
1	220	0.005	200	0.004	165	0.003	110	0.002	135	0.002	120	0.002	100	0.001
2		0.008		0.008		0.008		0.006		0.006		0.004		0.003
3		0.013		0.013		0.013		0.011		0.011		0.006		0.006
4		0.018		0.018		0.017		0.015		0.015		0.009		0.009
5		0.023		0.023		0.023		0.021		0.020		0.013		0.012
6		0.029		0.028		0.028		0.027		0.026		0.017		0.016
8		0.042		0.040		0.041		0.041		0.038		0.027		0.026
10		0.056		0.053		0.055		0.056		0.053		0.038		0.037
12		0.072		0.066		0.070		0.075		0.069		0.051		0.048
14		0.081		0.076		0.079		0.084		0.077		0.055		0.053
16		0.090		0.084		0.087		0.091		0.084		0.059		0.057
18		0.097		0.092		0.093		0.095		0.090		0.061		0.060
20		0.104		0.099		0.098		0.099		0.093		0.063		0.062
22		0.109		0.106		0.103		0.101		0.096		0.064		0.062
25		0.116		0.113		0.108		0.102		0.097		0.063		0.062

EZ DP/DH Endmills, 4 Flutes - C76

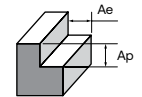

Side Milling	N				K		P				M			
Working Material	Wrought Aluminium		Cast Aluminium		Copper alloy		Grey Cast Iron		Carbon steel		Alloy steel		Stainless steel	
Properties	Si < 9%		Si ≥ 9%		-		-		-		520 < Rm < 1200		High Machinability	
Cutting depth, ap	1.00 x D		1.00 x D		1.00 x D		1.00 x D		1.00 x D		1.00 x D		1.00 x D	
Cutting Width, ae	0.30 x D		0.30 x D		0.30 x D		0.25 x D		0.25 x D		0.20 x D		0.18 x D	
D	Vc	Fz	Vc	Fz	Vc	Fz	Vc	Fz	Vc	Fz	Vc	Fz	Vc	Fz
1	275	0.005	240	0.004	200	0.003	140	0.004	165	0.003	130	0.003	110	0.003
2		0.010		0.009		0.007		0.008		0.007		0.007		0.007
3		0.016		0.014		0.012		0.013		0.012		0.011		0.012
4		0.021		0.019		0.017		0.017		0.016		0.015		0.016
5		0.027		0.025		0.022		0.023		0.021		0.020		0.021
6		0.033		0.031		0.028		0.028		0.027		0.025		0.026
8		0.046		0.044		0.042		0.040		0.039		0.036		0.038
10		0.060		0.058		0.057		0.053		0.053		0.047		0.051
12		0.075		0.074		0.074		0.066		0.069		0.060		0.065
14		0.086		0.084		0.083		0.076		0.078		0.068		0.073
16		0.096		0.093		0.091		0.085		0.085		0.076		0.080
18		0.106		0.101		0.097		0.092		0.090		0.083		0.086
20		0.115		0.108		0.103		0.099		0.095		0.088		0.093
22		0.123		0.114		0.108		0.105		0.099		0.093		0.097
25		0.134		0.122		0.110		0.113		0.103		0.099		0.104

ALU LINE
EZ LINE - ENDMILL
SE 30
NITICO 30
OPTIMUM
SE 45
SE 45X
NITICO 45
SE 60
SE 60X
DN70 - SE 70
SE GR
TE 45
PLUNGE -MILL
THREAD MILL

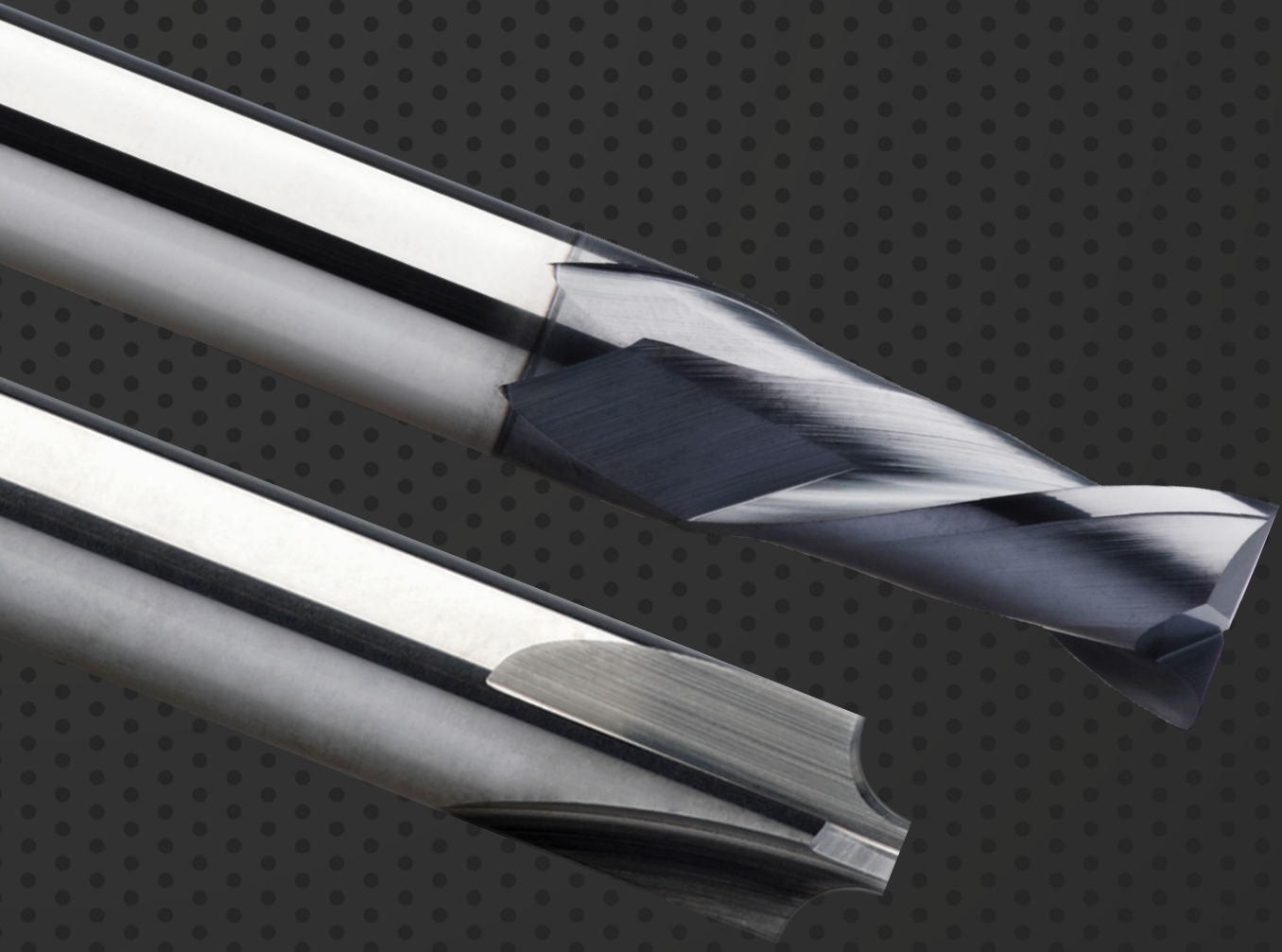

ENDMILLS

SE 30













For general machining

For material application ≤ 35 HRC

Index - SE 30, For ≤ 35 HRC

Suitable for Material Groups
 Adapté pour les matériaux
 适用于材料
 Geeignet für die Materialgruppen
 Adatto per il materiale

P
K
N

EDP Number	Type	No. Z	Helix Angle	Coating	Performance	Page Number
798	 SE 30	2	30°	B0819	G	93
800	 SE 30	3	30°	B0819	G	94
806	 SE 30 Long	4	30°	B0819	G	95
810	 SE 30 Extra-Long	4	30°	B0819	G	96
816	 SE 30	2	40°	B0819	G	97
818	 SE 30	3	40°	B0819	G	98
824	 SE 30 Long	4	40°	B0819	G	99
828	 SE 30 Extra-Long	4	40°	B0819	G	100
834	 SE 30 Multi Propose 60°	2	40°	B0819	G	101
836	 SE 30 Multi Propose 90°	2	40°	B0819	G	102
838	 SE 30 Multi Propose 120°	2	40°	B0819	G	103
398	 MG Mini 1/4 Corner	4	-	B0819	G	104

G - General P - Performance

FEATURES & BENEFITS

SE 30



Top View

1 Gash Land Design



Significantly improves strength and provide great chipping resistance

2 Eccentric Grinding

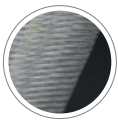

Optimum eccentric grinding in order to avoid rubbing, while maintaining maximum cutting tool strength.

3 Cutting Edge Preparation



- Enhances tool life
- Less material adhere on the cutting edge for stable machining
- Improves wear resistance and reduces excessive friction



4 Superior Coating to Reduce Friction

- Increases hardness and higher abrasive wear resistance
- Higher thermal resistance
- Smoother chips evacuation

5 Suitable for Material Groups





1. Stirnschliff Design
Verbessert die Leistung deutlich und bietet Schutz gegen Ausbrüche
2. Exzentrischer Schliff
Optimaler exzentrischer Schliff zur Reduzierung der Reibung unter Beibehaltung der maximalen Schneidenstabilität
3. Schneidkantenbehandlung
Verbessert die Werkzeuglebensdauer
Weniger Materialanhaftungen an der Schneide
Für stabile Bearbeitung
4. Ausgezeichnete Beschichtung zur Verringerung der Reibung
Erhöht die Härte und bietet bessere Verschleißfestigkeit
Höhere Temperaturbeständigkeit
Glatte Oberfläche für besseren Spänefluß
5. Positiver Spanwinkel
Geeignet für Materialgruppen P, K, N



1. 底刃斜面式设计
显著提高强度, 提供极好的耐崩裂性。
2. 偏心研磨
最佳偏心研磨, 可避免摩擦, 同时保持最大切削刀具强度。
3. 切削刃设置提高刀具寿命
提高刀具寿命。
较少的材料粘在切削刃上。
用于稳定加工。
4. 优异的涂层, 减少摩擦
增加硬度, 提高材料耐磨性。
更高的抗热性。
更顺畅的排屑。
5. 适用于材料 P、K、N



1. Struttura area sgrossatura
Migliora notevolmente la potenza e offre un'eccellente resistenza alle scheggiature
2. Levigatura orbitale
Levigatura orbitale ottimale per evitare sfregatura, garantendo la massima resistenza dello strumento di taglio.
3. Preparazione dell'angolo di taglio
Migliora la durata dello strumento
Meno materiale che aderisce sull'angolo di taglio
Per una lavorazione stabile
4. Rivestimento superiore per ridurre la frizione
Aumenta la durezza e una maggiore resistenza all'usura abrasiva
Resistenza termica superiore
Evacuazione dei trucioli più semplice
5. Angolo di taglio positivo
Adatto per il materiale P, K, N



1. Conception de fraise pour l'usinage general
Améliore considérablement la solidité et apporte une excellente résistance à l'ébarbage
2. Meulage excentrique
Meulage optimal diminuant le coefficient de friction tout en maintenant une bonne acuité de l'arête de coupe
3. Préparation des arêtes de coupes
Améliore la durée de vie de l'outil
Moins de matériau adhère à l'arête tranchante
Pour un usinage stable
4. Revêtement supérieur pour réduire la friction
Augmente la dureté et la résistance à l'abrasion
Résistance thermique supérieure
Évacuation des copeaux plus fluide
5. Angle de coupe positif
Adapté pour les matériaux P, K, N

SE 30 ENDMILLS, 2 FLUTES

- VHM SE 30 Fräser, 2 Zähne
- Frese SE 30, 2 taglienti
- Fraises SE 30 - 2 dents
- 整体硬质合金 SE 30 系列 2刀平底铣刀

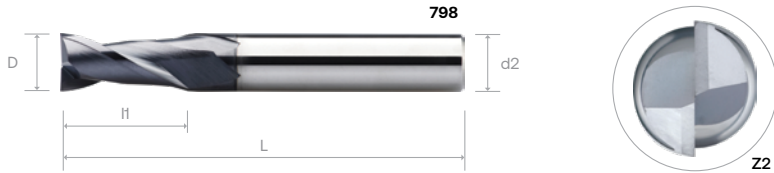

Order Number	Dimension (mm)					B0819
	D	l1	l2	L	d2 (h6)	
798 0100 040 03	1	3		40	3	○
798 0100 040 04				40	4	○
798 0150 040 03	15	4.5		40	3	●
798 0150 040 04				40	4	●
798 0200 040 03	2	6.5		40	3	●
798 0200 040 04				40	4	○
798 0250 040 03	2.5	6.5		40	3	○
798 0250 040 04				40	4	○
798 0300	3	9		40	3	○
798 0300 050 06				50	6	○
798 0400	4	12		50	4	●
798 0400 050 06				50	6	○
798 0500	5	15		50	5	●
798 0500 050 06				50	6	○
798 0600 050	6	16		50	6	●
798 0600 060			20		60	6
798 0800	8			64	8	●
798 1000 070	10	22		70	10	○
798 1000 075				75	10	○
798 1200	12	25		75	12	●
798 1400	14	32		90	14	●
798 1600	16			90	16	●
798 1800	18	38		100	18	○
798 2000	20			100	20	○
798 2200	22	40		100	22	○
798 2500	25			100	25	○

Material Group | Material-Gruppe | Groupe Matière | Gruppo Materiali | 材质主类

Cutting Parameter

N01	N02	N03	K01	K02	P01	P02	P03	M01	M02	S01	S02	S03	H01	H02	O01	O02	105
-----	-----	-----	-----	-----	-----	-----	-----	-----	-----	-----	-----	-----	-----	-----	-----	-----	-----

SE 30 ENDMILLS, 3 FLUTES

- VHM SE 30 Standard Fräser, 3 Zähne
- Frese SE 30, 3 taglienti
- Fraises SE 30 standard - 3 dents
- 整体硬质合金 SE 30 系列 3刃平底铣刀

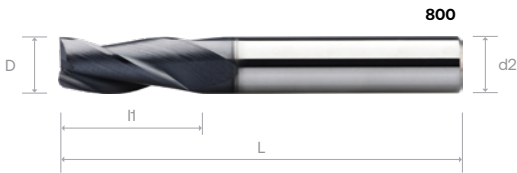

Order Number	Dimension (mm)					B0819
	D	I1	I2	L	d2 (h6)	
800 0100 040 03	1	3		40	3	•
800 0100 040 04			40	4	◦	
800 0150 040 03	1.5	4.5		40	3	◦
800 0150 040 04			40	4	◦	
800 0200 040 03	2	6.5		40	3	•
800 0200 040 04			40	4	◦	
800 0250 040 03	2.5	6.5		40	3	◦
800 0250 040 04			40	4	◦	
800 0300	3	9		40	3	◦
800 0300 050 06			50	6	◦	
800 0400	4	12		50	4	•
800 0400 050 06			50	6	•	
800 0500	5	15		50	5	◦
800 0500 050 06			50	6	◦	
800 0600 050	6	16		50	6	•
800 0600 060			60	6	◦	
800 0800	8	20		64	8	◦
800 1000 070	10		22		70	10
800 1000 075		75		10	◦	
800 1200	12	25		75	12	◦
800 1400	14		32		90	14
800 1600	16	38			90	16
800 1800	18		40		100	18
800 2000	20	40			100	20
800 2200	22		40		100	22
800 2500	25				100	25

- ALL LINE
- EZ LINE - ENDMILL
- SE 30
- NITICO 30
- OPTIMUM
- SE 45
- SE 45X
- NITICO 45
- SE 60
- SE 60X
- DN70 - SE70
- SE GR
- TE 45
- PLUNGE -MILL
- THREAD MILL

Material Group | Material-Gruppe | Groupe Matière | Gruppo Materiali | 材质主类

Cutting Parameter

N01	N02	N03	K01	K02	P01	P02	P03	M01	M02	S01	S02	S03	H01	H02	O01	O02	106
◦	◦	◦	◦	◦	◦	◦	◦	◦	◦	◦	◦	◦	◦	◦	◦	◦	

SE 30 LONG ENDMILLS, 4 FLUTES

- VHM SE30 Fräser, lang, 4 Zähne
- Frese lunghe SE 30, 4 taglienti
- Fraises SE 30 Longue - 4 dents
- 整体硬质合金 SE 30 系列 4刃长型平底铣刀

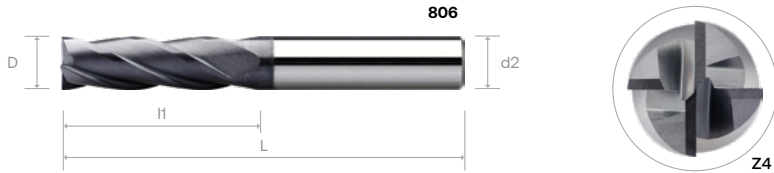

Order Number	Dimension (mm)					B0819
	D	L1	L2	L	d2 (h6)	
806 0300	3	19		60	3	•
806 0300 075 06				75	6	◦
806 0400	4			60	4	•
806 0400 075 06				75	6	•
806 0500	5			60	5	•
806 0500 075 06				75	6	•
806 0600	6	31		75	6	•
806 0800	8			75	8	•
806 1000 075	10			75	10	•
806 1000 100		50		100	10	◦
806 1200	12			100	12	•
806 1400	14	57		125	14	◦
806 1600	16			125	16	•
806 1800	18			125	18	◦
806 2000	20			125	20	◦

Material Group | Material-Gruppe | Groupe Matière | Gruppo Materiali | 材质主类

Cutting Parameter

N01	N02	N03	K01	K02	P01	P02	P03	M01	M02	S01	S02	S03	H01	H02	O01	O02	107
-----	-----	-----	-----	-----	-----	-----	-----	-----	-----	-----	-----	-----	-----	-----	-----	-----	-----

SE 30 EXTRA-LONG ENDMILLS, 4 FLUTES

- VHM SE 30 Fräser, extra-lang, 4 Zähne
- Frese extra-lunghe SE 30, 4 taglienti
- Fraises SE 30 Extra-Longue- 4 dents
- 整体硬质合金 SE 30 系列 4刃加长型平底铣刀

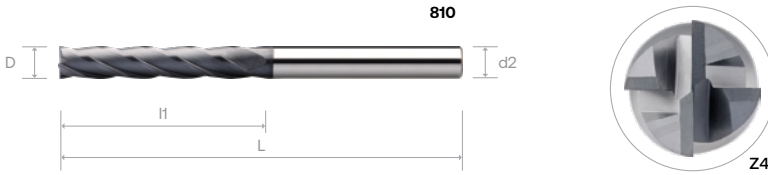

Order Number	Dimension (mm)					B0819
	D	L1	L2	L	d2 (h6)	
810 0300	3	25		100	3	°
810 0300 100 06				100	6	°
810 0400	4	31		100	4	•
810 0400 100 06				100	6	°
810 0500	5			100	5	•
810 0500 100 06				100	6	°
810 0600	6	38		100	6	•
810 0800	8	41		100	8	•
810 1000	10	57		125	10	•
810 1200	12	75		150	12	•
810 1400	14			150	14	°
810 1600	16			150	16	•
810 1800	18			150	18	°
810 2000	20			150	20	•

- ALL LINE
- EZ LINE - ENDMILL
- SE 30
- NITICO 30
- OPTIMUM
- SE 45
- SE 45X
- NITICO 45
- SE 60
- SE 60X
- DM70 - SE70
- SE GR
- TE 45
- PLUNGE -MILL
- THREAD MILL

Material Group | Material-Gruppe | Groupe Matière | Gruppo Materiali | 材质主类

Cutting Parameter

N01	N02	N03	K01	K02	P01	P02	P03	M01	M02	S01	S02	S03	H01	H02	O01	O02	107	
○	○	○	○	○	○													

SE 30 ENDMILLS, 2 FLUTES

- VHM SE 30 Fräser, 2 Zähne
- Frese SE 30, 2 taglienti
- Fraises SE 30 - 2 dents
- 整体硬质合金 SE 30 系列 2刃平底铣刀

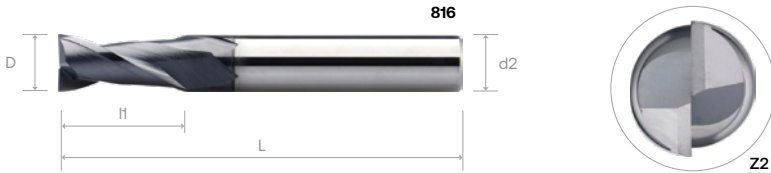

Order Number	Dimension (mm)					B0819
	D	l1	l2	L	d2 (h6)	
816 0100 040 03	1	3		40	3	○
816 0100 040 04				40	4	●
816 0150 040 03	15	4.5		40	3	●
816 0150 040 04				40	4	○
816 0200 040 03	2			40	3	●
816 0200 040 04				40	4	○
816 0250 040 03	2.5	6.5		40	3	●
816 0250 040 04				40	4	●
816 0300	3	9		40	3	●
816 0300 050 06				50	6	●
816 0350 050 04	3.5			50	4	●
816 0400				50	4	●
816 0400 050 06	4	12		50	6	●
816 0450 050 05				50	5	●
816 0500	5	15		50	5	●
816 0500 050 06				50	6	●
816 0550 050 06	5.5			50	6	○
816 0600 050				50	6	●
816 0600 060	6	16		60	6	○
816 0700 064 08				64	8	○
816 0800	8			64	8	●
816 0900 070 10				70	10	●
816 1000 070	10	22		70	10	○
816 1000 075				75	10	●
816 1100 075 12	11			75	12	○
816 1200				75	12	●
816 1400	14	32		90	14	●
816 1600				90	16	●
816 1800	18	38		100	18	●
816 2000				100	20	●
816 2200	22	40		100	22	○
816 2500				100	25	○

Material Group | Material-Gruppe | Groupe Matière | Gruppo Materiali | 材质主类

Cutting Parameter

N01	N02	N03	K01	K02	P01	P02	P03	M01	M02	S01	S02	S03	H01	H02	O01	O02	105
-----	-----	-----	-----	-----	-----	-----	-----	-----	-----	-----	-----	-----	-----	-----	-----	-----	-----

SE 30 ENDMILLS, 3 FLUTES

- VHM SE 30 Fräser, 3 Zähne
- Frese SE 30, 3 taglienti
- Fraises SE 30 - 3 dents
- 整体硬质合金 SE 30 系列 3刃平底铣刀

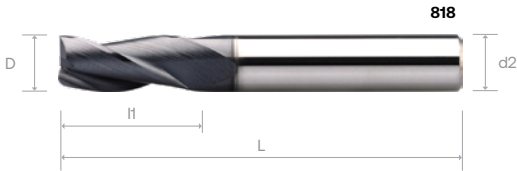

Order Number	Dimension (mm)					B0819
	D	I1	I2	L	d2 (h6)	
818 0100 040 03	1	3		40	3	•
818 0100 040 04				40	4	◦
818 0150 040 03	1.5	4.5		40	3	•
818 0150 040 04				40	4	•
818 0200 040 03	2	6.5		40	3	•
818 0200 040 04				40	4	•
818 0250 040 03	2.5			40	3	•
818 0250 040 04				40	4	•
818 0300	3	9		40	3	•
818 0300 050 06				50	6	•
818 0350 050 04	3.5			50	4	•
818 0400				50	4	•
818 0400 050 06	4	12		50	6	•
818 0450 050 05				50	5	•
818 0500	5			50	5	•
818 0500 050 06				50	6	•
818 0550 050 06	5.5			50	6	◦
818 0600 050				50	6	•
818 0600 060	6	16		60	6	•
818 0700 064 08				64	8	•
818 0800	8			64	8	•
818 0900 070 10				70	10	•
818 1000 070	10	22		70	10	•
818 1000 075				75	10	•
818 1100 075 12	11			75	12	•
818 1200				75	12	•
818 1400	14	32		90	14	•
818 1600				90	16	•
818 1800	18	38		100	18	◦
818 2000				100	20	•
818 2200	22	40		100	22	◦
818 2500				100	25	◦

- ALL LINE
- EZ LINE - ENDMILL
- SE 30
- NITICO 30
- OPTIMUM
- SE 45
- SE 45X
- NITICO 45
- SE 60
- SE 60X
- DM70 - SE 70
- SE GR
- TE 45
- PLUNGE -MILL
- THREAD MILL

Material Group | Material-Gruppe | Groupe Matière | Gruppo Materiali | 材质主类

Cutting Parameter

N01	N02	N03	K01	K02	P01	P02	P03	M01	M02	S01	S02	S03	H01	H02	O01	O02	106	
◦	◦	◦	◦	◦	◦													

SE 30 LONG ENDMILLS, 4 FLUTES

- VHM SE30 Fräser, lang, 4 Zähne
- Frese lunghe SE 30, 4 taglienti
- Fraises SE 30 Longue - 4 dents
- 整体硬质合金 SE 30 系列 4刃长型平底铣刀

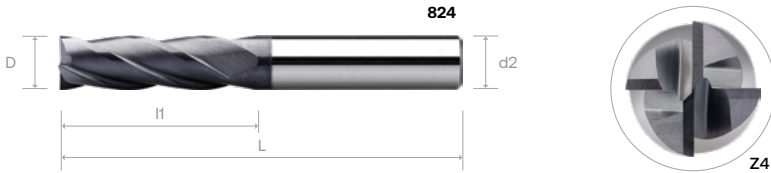

Order Number	Dimension (mm)					B0819
	D	L1	L2	L	d2 (h6)	
824 0300	3	19		60	3	°
824 0300 060 04				60	4	°
824 0300 075 06				75	6	•
824 0400	4	19		60	4	•
824 0400 075 06				75	6	°
824 0500	5	19		60	5	°
824 0500 075 06				75	6	•
824 0600	6	31		75	6	•
824 0800				8	75	8
824 1000 075	10	50		75	10	•
824 1000 100				100	10	•
824 1200	12	50		100	12	•
824 1400				14	125	14
824 1600	16	57		125	16	•
824 1800				18	125	18
824 2000	20	57		125	20	•

Material Group | Material-Gruppe | Groupe Matière | Gruppo Materiali | 材质主类

Cutting Parameter

N01	N02	N03	K01	K02	P01	P02	P03	M01	M02	S01	S02	S03	H01	H02	O01	O02	107
-----	-----	-----	-----	-----	-----	-----	-----	-----	-----	-----	-----	-----	-----	-----	-----	-----	-----

ALU LINE
 EZ LINE - ENDMILL
 SE 30
 NITCo 30
 OPTIMUM
 SE 45
 SE 45X
 NITCo 45
 SE 60
 SE 60X
 DM70 - SE70
 SE GR
 TE 45
 PLUNGE -MILL
 THREAD MILL

SE 30 EXTRA-LONG ENDMILLS, 4 FLUTES

- VHM SE 30 Fräser, extra-lang, 4 Zähne
- Frese extra-lunghe SE 30, 4 taglienti
- Fraises SE 30 Extra-Longue- 4 dents
- 整体硬质合金 SE 30 系列 4刃加长型平底铣刀

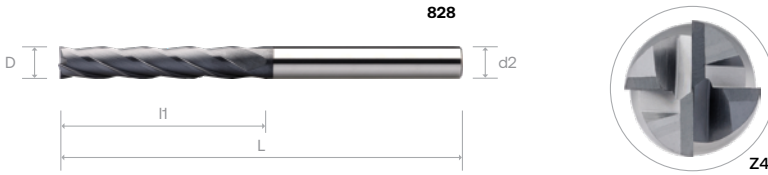

Order Number	Dimension (mm)					B0819
	D	L1	L2	L	d2 (h6)	
828 0300	3	25		100	3	•
828 0300 100 04				100	4	◦
828 0300 100 06				100	6	◦
828 0400	4	31		100	4	•
828 0400 100 06				100	6	◦
828 0500	5			31		100
828 0500 100 06		100	6			◦
828 0600	6	38		100	6	•
828 0800	8	41		100	8	•
828 1000	10	57		125	10	•
828 1200	12	75		150	12	•
828 1400	14			150	14	◦
828 1600	16			150	16	◦
828 1800	18			150	18	◦
828 2000	20			150	20	◦

- ALL LINE
- EZ LINE - ENDMILL
- SE 30
- NITICO 30
- OPTIMUM
- SE 45
- SE 45X
- NITICO 45
- SE 60
- SE 60X
- DM70 - SE 70
- SE GR
- TE 45
- PLUNGE -MILL
- THREAD MILL

Material Group | Material-Gruppe | Groupe Matière | Gruppo Materiali | 材质主类

Cutting Parameter

N01	N02	N03	K01	K02	P01	P02	P03	M01	M02	S01	S02	S03	H01	H02	O01	O02	107
-----	-----	-----	-----	-----	-----	-----	-----	-----	-----	-----	-----	-----	-----	-----	-----	-----	-----

SE 30 MULTI-PURPOSE ENDMILLS WITH 60° POINT ANGLE, 2 FLUTES

- VHM SE 30 Mehrzweck-Fräser, Spitzenwinkel: 60°
- Frese per impiego multiplo SE 30, angolo di punta 60°, 2 taglianti
- Fraises SE 30 multiple usage, 60° angle de pointe
- 整体硬质合金 SE 30 系列 多功能2刀倒角60°铣刀

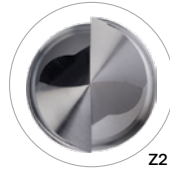
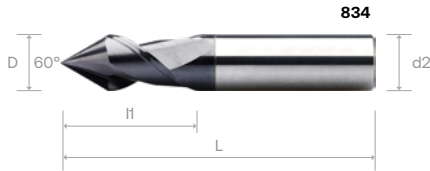

Order Number	Dimension (mm)					B0819
	D	l1	l2	L	d2 (h6)	
834 0300 040	3	9		40	3	•
834 0400 050	4	12		50	4	•
834 0500 050	5	15		50	5	•
834 0600 050	6	16		50	6	•
834 0800 064	8	20		64	8	•
834 1000 070	10	22		70	10	•
834 1200 075	12	25		75	12	◦
834 1600 090	16	32		90	16	•
834 2000 100	20	38		100	20	•

Condition				
V-Groove	V-Nut	Rainure-V	Ranura V	V-槽
Chamfer	Senken	Chamfreiner	Svasare	倒角
Interpolation	Zirkularfräsen	Interpolation	Interpolazione	插值法
Drilling	Bohren	Percer	Forare	钻孔
Centering-Spotting	Zentrieren / Positionieren	Centrer / Positionner	Centrare / Posizionare	中心钻
Side Milling & Chamfer	Kantenbearbeitung und Senken	Usinage Latéral et Chamfreiner	Asportazione Laterale e Svasare	铣边 & 倒角

Material Group | Material-Gruppe | Groupe Matière | Gruppo Materiali | 材质主类

Cutting Parameter

N01	N02	N03	K01	K02	P01	P02	P03	M01	M02	S01	S02	S03	H01	H02	O01	O02	108
-----	-----	-----	-----	-----	-----	-----	-----	-----	-----	-----	-----	-----	-----	-----	-----	-----	-----

ALU LINE
 EZ LINE -
 ENDMILL
 SE 30
 NITCo 30
 OPTIMUM
 SE 45
 SE 45X
 NITCo 45
 SE 60
 SE 60X
 DM70 -
 SE70
 SE GR
 TE 45
 PLUNGE
 -MILL
 THREAD
 MILL

SE 30 MULTI-PURPOSE ENDMILLS WITH 90° POINT ANGLE, 2 FLUTES

- VHM SE 30 Mehrzweck-Fräser, Spitzenwinkel: 90°
- Frese per impiego multiplo SE 30, angolo di punta 90°, 2 taglienti
- Fraises SE 30 multiple usage, 90° angle de pointe
- 整体硬质合金 SE 30 系列 多功能 2刃倒角90°铣刀

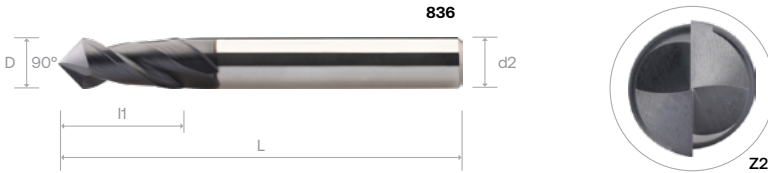

Order Number	Dimension (mm)					B0819
	D	I1	I2	L	d2 (h6)	
836 0300 040	3	9		40	3	•
836 0400 050	4	12		50	4	•
836 0500 050	5	15		50	5	•
836 0600 050	6	16		50	6	•
836 0800 064	8	20		64	8	•
836 1000 070	10	22		70	10	•
836 1200 075	12	25		75	12	•
836 1600 090	16	32		90	16	•
836 2000 100	20	38		100	20	•

Condition				
V-Groove	V-Nut	Rainure-V	Ranura V	V-槽
Chamfer	Senken	Chamfreiner	Svasare	倒角
Interpolation	Zirkularfräsen	Interpolation	Interpolazione	插值法
Drilling	Bohren	Percer	Forare	钻孔
Centering-Spotting	Zentrieren / Positionieren	Centrer / Positionner	Centrare / Posizionare	中心钻
Side Milling & Chamfer	Kantenbearbeitung und Senken	Usinage Latéral et Chamfreiner	Asportazione Laterale e Svasare	铣边 & 倒角

Material Group | Material-Gruppe | Groupe Matière | Gruppo Materiali | 材质主类

N01	N02	N03	K01	K02	P01	P02	P03	M01	M02	S01	S02	S03	H01	H02	O01	O02
-----	-----	-----	-----	-----	-----	-----	-----	-----	-----	-----	-----	-----	-----	-----	-----	-----

Cutting Parameter

108

SE 30 MULTI-PURPOSE ENDMILLS WITH 120° POINT ANGLE, 2 FLUTES

- VHM SE 30 Mehrzweck-Fräser, Spitzenwinkel: 120°
- Frese per impiego multiplo SE 30, angolo di punta 120°, 2 taglienti
- Fraises SE 30 multiple usage, 120° angle de pointe
- 整体硬质合金 SE 30 系列 多功能 2刃倒角120°铣刀

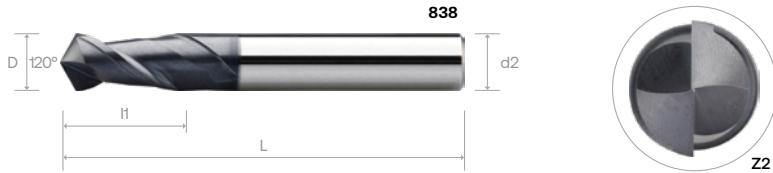

Order Number	Dimension (mm)					B0819
	D	l1	l2	L	d2 (h6)	
838 0300 040	3	9		40	3	°
838 0400 050	4	12		50	4	°
838 0500 050	5	15		50	5	°
838 0600 050	6	16		50	6	°
838 0800 064	8	20		64	8	°
838 1000 070	10	22		70	10	°
838 1200 075	12	25		75	12	°
838 1600 090	16	32		90	16	°
838 2000 100	20	38		100	20	°

Condition				
V-Groove	V-Nut	Rainure-V	Ranura V	V-槽
Chamfer	Senken	Chamfreiner	Svasare	倒角
Interpolation	Zirkularfräsen	Interpolation	Interpolazione	插值法
Drilling	Bohren	Percer	Forare	钻孔
Centering-Spotting	Zentrieren / Positionieren	Centrer / Positionner	Centrare / Posizionare	中心钻
Side Milling & Chamfer	Kantenbearbeitung und Senken	Usinage Latéral et Chamfreiner	Asportazione Laterale e Svasare	铣边 & 倒角

Material Group | Material-Gruppe | Groupe Matière | Gruppo Materiali | 材质主类

Cutting Parameter

N01	N02	N03	K01	K02	P01	P02	P03	M01	M02	S01	S02	S03	H01	H02	O01	O02	108
-----	-----	-----	-----	-----	-----	-----	-----	-----	-----	-----	-----	-----	-----	-----	-----	-----	-----

ROUND CORNER MILLING CUTTERS, 4 FLUTES

- VHM Viertelrund Profilfräser, 4 Zähne
- Frese raggate per contornatura, 4 taglienti
- Fraises 1/4 de cercle, 4 dents
- 整体硬质合金 4刃内圆弧R角铣刀

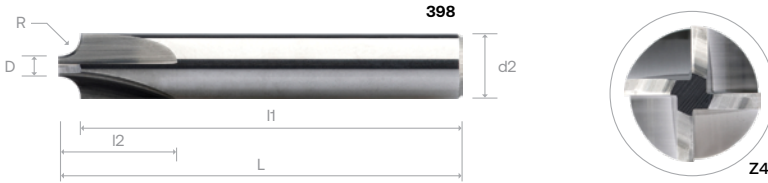

Order Number	Dimension (mm)						B0819
	D ± 0.1	R ± 0.02	l1	l2	L	d2 (h6)	
398 0025 010	10	0.25	49.48	7	50	3	•
398 0030 010		0.30	49.46	7	50	3	•
398 0040 010		0.40	49.36	7	50	3	•
398 0050 015	15	0.50	49.24	10	50	4	•
398 0060 015		0.60	49.14	10	50	4	◦
398 0070 015		0.70	49.05	10	50	4	◦
398 0080 015		0.80	48.96	10	50	4	•
398 0090 015		0.90	48.87	10	50	4	◦
398 0100 015		1.00	48.78	10	50	4	•
398 0125 020	2.0	1.25	48.49	12	50	6	•
398 0150 020		1.50	48.26	12	50	6	•
398 0175 020		1.75	48.03	12	50	6	◦
398 0200 025	2.5	2.00	47.74	14	50	8	◦
398 0225 025		2.25	47.51	14	50	8	◦
398 0250 025		2.50	47.28	14	50	8	•
398 0150 035	3.5	1.50	68.27	16	70	10	◦
398 0200 030	3.0	2.00	67.84	16	70	10	◦
398 0250 035	3.5	2.50	72.36	18	75	12	◦
398 0300 030	3.0	3.00	71.92	18	75	12	•
398 0350 045	4.5	3.50	86.4	20	90	16	◦
398 0400 040	4.0	4.00	85.96	20	90	16	◦
398 0450 035	3.5	4.50	85.52	20	90	16	◦
398 0500 030	3.0	5.00	85.09	20	90	16	◦
398 0550 045	4.5	5.50	94.56	22	100	20	◦
398 0600 040	4.0	6.00	94.13	22	100	20	◦

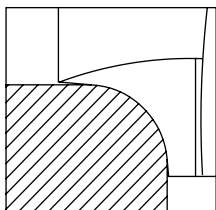

These cutters are designed for CNC machines. They allow to machine even very thin materials. Easy to regrind.

- Diese Profilfräser sind für den Einsatz auf CNC Maschinen, und für die Bearbeitung dünner Werkstücke geeignet und leicht nachschleifbar.
- Queste frese 1/4 circolare sono concepite per l'impiego su centri CNC, e permettono di lavorare parti sottili. Riaffilatura facile.
- Ces fraises 1/4 de cercle sont conçues pour l'emploi sur des centres CNC, et permettent d'usiner des matériaux très minces. Faciles à réaffûter.
- 此切削刀是專為CNC加工中心設計使用。可以在非常薄片工件加工。容易再磨研。

Material Group | Material-Gruppe | Groupe Matière | Gruppo Materiali | 材质主类

Cutting Parameter

N01	N02	N03	K01	K02	P01	P02	P03	M01	M02	S01	S02	S03	H01	H02	O01	O02
-----	-----	-----	-----	-----	-----	-----	-----	-----	-----	-----	-----	-----	-----	-----	-----	-----

108

Note: These recommended cutting data indicators are just for reference. They should be adjusted according to the different cutting condition



SE 30 Endmills, 2 Flutes - 798, 816

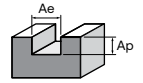

Slotting	N				K		P			
Working Material	Wrought Aluminium		Cast Aluminium		Copper alloy		Grey Cast Iron		Carbon steel	
Properties	Si < 9%		Si ≥ 9%		-		-		-	
Cutting depth, ap	0.55 x D		0.55 x D		0.55 x D		0.50 x D		0.50 x D	
Cutting Width, ae	1.00 x D		1.00 x D		0.24 x D		1.00 x D		1.00 x D	
D	Vc	Fz	Vc	Fz	Vc	Fz	Vc	Fz	Vc	Fz
1	230	0.009	210	0.009	180	0.008	80	0.009	115	0.006
2		0.018		0.017		0.016		0.019		0.015
3		0.024		0.023		0.022		0.025		0.024
4		0.032		0.031		0.029		0.034		0.032
5		0.040		0.038		0.036		0.042		0.040
6		0.050		0.048		0.045		0.053		0.049
8		0.067		0.064		0.061		0.071		0.067
10		0.085		0.081		0.077		0.090		0.083
12		0.101		0.096		0.091		0.106		0.098
14		0.118		0.112		0.106		0.123		0.115
16		0.128		0.121		0.115		0.134		0.129
18		0.144		0.137		0.130		0.151		0.145
20		0.145		0.138		0.131		0.152		0.155
22		0.149		0.141		0.134		0.156		0.168
25		0.162		0.154		0.146		0.170		0.189

SE 30 Endmills, 2 Flutes - 798, 816

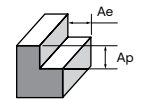

Side Milling	N				K		P			
Working Material	Wrought Aluminium		Cast Aluminium		Copper alloy		Grey Cast Iron		Carbon steel	
Properties	Si < 9%		Si ≥ 9%		-		-		-	
Cutting depth, ap	1.00 x D		1.00 x D		1.00 x D		1.00 x D		1.00 x D	
Cutting Width, ae	0.30 x D		0.30 x D		0.30 x D		0.25 x D		0.25 x D	
D	Vc	Fz	Vc	Fz	Vc	Fz	Vc	Fz	Vc	Fz
1	280	0.011	250	0.010	210	0.010	120	0.011	140	0.006
2		0.022		0.021		0.020		0.023		0.012
3		0.029		0.028		0.026		0.030		0.021
4		0.039		0.037		0.035		0.041		0.028
5		0.048		0.046		0.044		0.051		0.034
6		0.060		0.057		0.055		0.064		0.044
8		0.081		0.077		0.073		0.085		0.059
10		0.102		0.097		0.092		0.108		0.075
12		0.121		0.115		0.109		0.127		0.094
14		0.141		0.134		0.127		0.148		0.107
16		0.153		0.146		0.138		0.161		0.123
18		0.172		0.164		0.156		0.181		0.133
20		0.174		0.165		0.157		0.182		0.143
22		0.178		0.169		0.161		0.187		0.152
25		0.195		0.185		0.176		0.204		0.162

ALU LINE
ENDMILL
SE 30
NITCo 30
OPTIMUM
SE 45
SE 45X
NITCo 45
SE 60
SE 60X
DM70 - SE70
SE GR
TE 45
PLUNGE-MILL
THREAD MILL

Recommended Cutting Data



Note: These recommended cutting data indicators are just for reference. They should be adjusted according to the different cutting condition



SE 30 Endmills, 3 Flutes - 800, 818

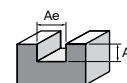

Slotting	N				K		P			
Working Material	Wrought Aluminium		Cast Aluminium		Copper alloy		Grey Cast Iron		Carbon steel	
Properties	Si < 9%		Si ≥ 9%		-		-		-	
Cutting depth, ap	0.55 x D		0.55 x D		0.55 x D		0.50 x D		0.50 x D	
Cutting Width, ae	1.00 x D		1.00 x D		0.24 x D		1.00 x D		1.00 x D	
D	Vc	Fz	Vc	Fz	Vc	Fz	Vc	Fz	Vc	Fz
1	230	0.009	210	0.009	180	0.008	80	0.008	115	0.005
2		0.018		0.017		0.015		0.016		0.011
3		0.024		0.023		0.022		0.025		0.018
4		0.032		0.030		0.029		0.034		0.024
5		0.040		0.038		0.036		0.042		0.030
6		0.050		0.048		0.045		0.053		0.037
8		0.067		0.064		0.061		0.071		0.050
10		0.085		0.081		0.077		0.089		0.063
12		0.101		0.096		0.091		0.106		0.074
14		0.117		0.111		0.106		0.123		0.087
16		0.127		0.121		0.115		0.134		0.097
18		0.143		0.136		0.129		0.150		0.110
20		0.145		0.138		0.131		0.152		0.118
22	0.159	0.151	0.144	0.167	0.128					
25	0.163	0.155	0.147	0.171	0.143					

SE 30 Endmills, 3 Flutes - 800, 818

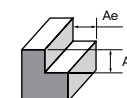

Side Milling	N				K		P			
Working Material	Wrought Aluminium		Cast Aluminium		Copper alloy		Grey Cast Iron		Carbon steel	
Properties	Si < 9%		Si ≥ 9%		-		-		-	
Cutting depth, ap	1.00 x D		1.00 x D		1.00 x D		1.00 x D		1.00 x D	
Cutting Width, ae	0.30 x D		0.30 x D		0.30 x D		0.25 x D		0.25 x D	
D	Vc	Fz	Vc	Fz	Vc	Fz	Vc	Fz	Vc	Fz
1	280	0.011	250	0.010	210	0.010	120	0.011	140	0.005
2		0.022		0.021		0.020		0.023		0.010
3		0.029		0.027		0.026		0.030		0.016
4		0.038		0.037		0.035		0.040		0.021
5		0.048		0.046		0.043		0.050		0.027
6		0.060		0.057		0.054		0.063		0.034
8		0.081		0.077		0.073		0.085		0.047
10		0.102		0.097		0.092		0.107		0.059
12		0.121		0.115		0.109		0.127		0.074
14		0.141		0.134		0.127		0.148		0.084
16		0.153		0.145		0.138		0.160		0.096
18		0.172		0.163		0.155		0.181		0.103
20		0.174		0.165		0.157		0.182		0.112
22	0.191	0.181	0.172	0.201	0.117					
25	0.195	0.185	0.176	0.205	0.127					

ALU LINE
EZ LINE -
ENDMILL
SE 30
NITCO 30
OPTIMUM
SE 45
SE 45X
NITCO 45
SE 60
SE 60X
DN70 -
SE 70
SE GR
TE 45
PLUNGE
-MILL
THREAD
MILL

Note: These recommended cutting data indicators are just for reference. They should be adjusted according to the different cutting condition



SE 30 Long Endmills, 4 Flutes - 806, 824

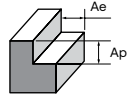

Side Milling	N				K		P						
Working Material	Wrought Aluminium		Cast Aluminium		Copper alloy		Grey Cast Iron		Carbon steel				
Properties	Si < 9%		Si ≥ 9%		-		-		-				
Cutting depth, ap	1.50 x D		1.50 x D		1.50 x D		1.50 x D		1.50 x D				
Cutting Width, ae	0.25 x D		0.25 x D		0.25 x D		0.20 x D		0.20 x D				
D	Vc	Fz	Vc	Fz	Vc	Fz	Vc	Fz	Vc	Fz			
3	220	0.015	190	0.014	150	0.012	100	0.010	120	0.012			
4		0.021		0.019							0.018	0.015	0.017
5		0.027		0.025							0.023	0.021	0.023
6		0.033		0.031							0.030	0.028	0.029
8		0.045		0.043							0.041	0.041	0.041
10		0.059		0.055							0.055	0.056	0.055
12		0.073		0.069							0.069	0.073	0.071
14		0.083		0.078							0.077	0.079	0.078
16		0.091		0.086							0.084	0.084	0.084
18		0.100		0.093							0.090	0.086	0.088
20		0.107		0.099							0.094	0.087	0.092

SE 30 Extra-Long Endmills, 4 Flutes - 810, 828

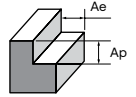

Side Milling	N				K		P						
Working Material	Wrought Aluminium		Cast Aluminium		Copper alloy		Grey Cast Iron		Carbon steel				
Properties	Si < 9%		Si ≥ 9%		-		-		-				
Cutting depth, ap	2.00 x D		2.00 x D		2.00 x D		2.00 x D		2.00 x D				
Cutting Width, ae	0.22 x D		0.22 x D		0.22 x D		0.18 x D		0.18 x D				
D	Vc	Fz	Vc	Fz	Vc	Fz	Vc	Fz	Vc	Fz			
3	190	0.015	160	0.013	120	0.012	80	0.012	90	0.010			
4		0.021		0.018							0.017	0.018	0.015
5		0.027		0.024							0.023	0.023	0.021
6		0.033		0.031							0.029	0.029	0.028
8		0.046		0.043							0.041	0.040	0.041
10		0.060		0.056							0.055	0.053	0.056
12		0.074		0.071							0.071	0.067	0.073
14		0.084		0.079							0.078	0.075	0.079
16		0.093		0.086							0.084	0.083	0.084
18		0.100		0.093							0.088	0.089	0.086
20		0.108		0.098							0.092	0.095	0.087

ALU LINE
 ENDMILL
 SE 30
 NITCo 30
 OPTIMUM
 SE 45
 SE 45X
 NITCo 45
 SE 60
 SE 60X
 DM70 - SE70
 SE GR
 TE 45
 PLUNGE -MILL
 THREAD MILL

Note: These recommended cutting data indicators are just for reference. They should be adjusted according to the different cutting condition



SE 30 Multi-Purpose Endmills, 2 Flutes - 834, 836, 838

Chamfering	N						K		P	
Working Material	Wrought Aluminium		Cast Aluminium		Copper alloy		Grey Cast Iron		Carbon steel	
Properties	Si < 9%		Si ≥ 9%		-		-		-	
Cutting depth, ap										
Cutting Width, ae										
D	Vc	Fz	Vc	Fz	Vc	Fz	Vc	Fz	Vc	Fz
3	230	0.026	200	0.023	160	0.020	110	0.020	130	0.021
4		0.037		0.033		0.028		0.028		0.029
5		0.047		0.043		0.037		0.036		0.037
6		0.059		0.054		0.047		0.045		0.046
8		0.081		0.075		0.065		0.063		0.063
10		0.105		0.097		0.085		0.081		0.081
12		0.131		0.123		0.107		0.103		0.101
16		0.164		0.151		0.157		0.128		0.127
20		0.191		0.173		0.180		0.149		0.150

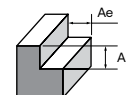

SE 30 Miniature Round Corner Milling Cutter, 4 Flutes - 398

Side Milling	N						K		P	
Working Material	Wrought Aluminium		Cast Aluminium		Copper alloy		Grey Cast Iron		Carbon steel	
Properties	Si < 9%		Si ≥ 9%		-		-		-	
Cutting depth, ap	0.24xD		0.24xD		0.24xD		0.24xD		0.24xD	
Cutting Width, ae	0.02xD		0.02xD		0.02xD		0.02xD		0.02xD	
D	Vc	Fz	Vc	Fz	Vc	Fz	Vc	Fz	Vc	Fz
1	315	0.008	205	0.006	135	0.005	175	0.003	240	0.003
2		0.008		0.010		0.011		0.006		0.005
3		0.012		0.015		0.017		0.009		0.008
4		0.017		0.021		0.024		0.013		0.011
5		0.022		0.027		0.032		0.018		0.015
6		0.027		0.033		0.040		0.022		0.018

ALU LINE
EZ LINE -
ENDMILL
SE 30
NITCO 30
OPTIMUM
SE 45
SE 45X
NITCO 45
SE 60
SE 60X
DN70 -
SE 70
SE GR
TE 45
PLUNGE
-MILL
THREAD
MILL

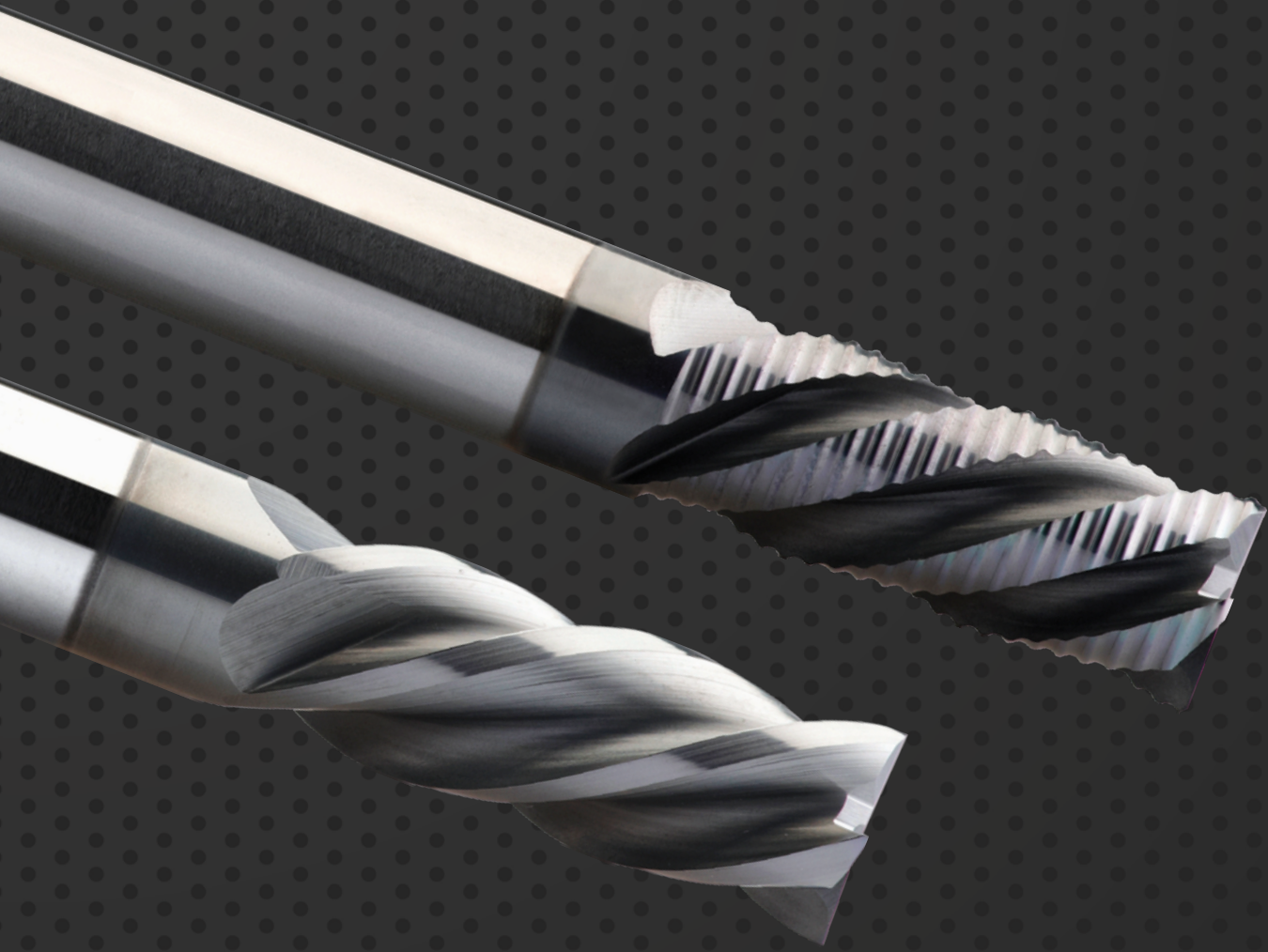

ENDMILLS

NiTiCo 30

Manufacture to the highest standards

For material application ≤ 45 HRC

Index - NiTiCo 30, For ≤ 45 HRC

Suitable for Material Groups

Adapté pour les matériaux

适用于材料

P **M** **K**

Geeignet für die Materialgruppen

Adatto per il materiale

EDP Number	Type	No. Z	Helix Angle	Coating	Performance	Page Number
C30	NiTiCo 30	2	30°	G6110	G	112
C31	NiTiCo 30	3	30°	G6110	G	113
C42	NiTiCo 30, Weldon	2	30°	G6110	G	114
C43	NiTiCo 30, Weldon	3	30°	G6110	G	115
C44	NiTiCo 30, Weldon	4	30°	G6110	G	116
951	NiTiCo 30 DP	4	40°	G6110	P	119
972	NiTiCo 30 DP, Weldon	4	40°	G6110	P	119
C46	NiTiCo 30 DP Torus	4	40°	G6110	P	120
C52	NiTiCo 30 DP Torus, Weldon	4	40°	G6110	P	120
J89	NiTiCo 30 DH	5	a° = b°	G6110	P	122
J90	NiTiCo 30 DH, Weldon	5	a° = b°	G6110	P	122
J92	NiTiCo 30 DH Long	5	a° = b°	G6110	P	123
J93	NiTiCo 30 DH Long, Weldon	5	a° = b°	G6110	P	123
NEW K65	NiTiCo 30 DH Internal Oil Hole, Weldon, Recess	5	a° = b°	G6110	P	126
NEW K67	NiTiCo 30 DH Long Internal Oil Hole, Weldon, Recess	5	a° = b°	G6110	P	127
NEW 949	NiTiCo 30 DP/DH	4	a° = b°	G6110	P	130
NEW C49	NiTiCo 30 DP/DH, Weldon	4	a° = b°	G6110	P	130
NEW K78	NiTiCo 30 DP/DH, Weldon, Recess	4	a° = b°	G6110	P	131
NEW K70	NiTiCo 30 DP/DH Internal Oil Hole, Weldon, Recess	4	a° = b°	G6110	P	131
C48	NiTiCo 30 DP/DH	4	a° = b°	G6110	P	132
C50	NiTiCo 30 DP/DH, Weldon	4	a° = b°	G6110	P	133
NEW J01	NiTiCo 30 DP/DH, Recess	4	a° = b°	G6110	P	134
NEW H98	NiTiCo 30 DP/DH, Recess, Weldon	4	a° = b°	G6110	P	134
A1R	NiTiCo 30 DP/DH	4	a° = b°	B0909	P	132
A1T	NiTiCo 30 DP/DH, Weldon	4	a° = b°	B0909	P	133







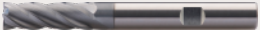

G - General P - Performance

cont'd ►

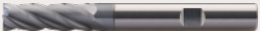
Index - NiTiCo 30, For ≤45 HRC

Suitable for Material Groups
 Adapté pour les matériaux
 适用于材料
 Geeignet für die Materialgruppen
 Adatto per il materiale

P
M
K

EDP Number	Type	No. Z	Helix Angle	Coating	Performance	Page Number
H38 	NiTiCo 30 DP/DH Long, Recess	4	a° ≠ b°	G6110	P	135
H39 	NiTiCo 30 DP/DH Long, Recess, Weldon	4	a° ≠ b°	G6110	P	135
J97 	NiTiCo 30 DP/DH Long	4	a° ≠ b°	G6110	P	135
J98 	NiTiCo 30 DP/DH Long, Weldon	4	a° ≠ b°	G6110	P	135
C47 	NiTiCo 30 Roughing	4	40°	G6110	P	136
C64 	NiTiCo 30 Roughing, Weldon	4	40°	G6110	P	136
G87 	NiTiCo 30 Miniature Long Neck	2	40°	G6110	G	137
G88 	NiTiCo 30 Miniature Long Neck	2	30°	G6110	G	141
H56 	NiTiCo 30 Miniature Long Neck	2	40°	G6110	G	139

G - General P - Performance

NITICO 30 ENDMILLS, 2 FLUTES

- VHM NiTiCo 30 Fräser , 2 Zähne
- Frese NiTiCo 30, 2 taglienti
- Fraises NiTiCo 30 - 2 dents
- 整体硬质合金 NiTiCo 30 系列 2/3/4刃平底铣刀

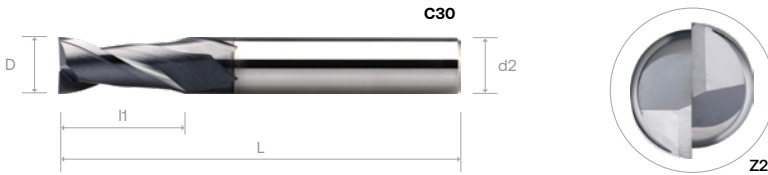

Order Number	Dimension (mm)					G6110
	D	I1	I2	L	d2 (h6)	
C30 0100 040 03	1	3		40	3	°
C30 0100 050 04				50	4	•
C30 0150 040 03	1.5	4.5		40	3	°
C30 0150 050 04				50	4	°
C30 0200 040 03 *	2	6.5		40	3	°
C30 0200 050 04				50	4	°
C30 0250 040 03	2.5	6.5		40	3	°
C30 0250 050 04				50	4	°
C30 0300	3	9		40	3	°
C30 0300 050 06				50	6	°
C30 0400	4	12		50	4	°
C30 0400 050 06				50	6	°
C30 0500	5	15		50	5	°
C30 0500 050 06				50	6	°
C30 0600 050	6	16		50	6	°
C30 0600 060				60	6	°
C30 0800	8	20		64	8	°
C30 1000 070	10		22		70	10
C30 1000 075				75	10	°
C30 1200	12	25		75	12	°
C30 1400	14		32		90	14
C30 1600	16	38			90	16
C30 1800	18		38		100	18
C30 2000	20				100	20

* - DIN 6535

ALU LINE
 EZ LINE - ENDMILL
 SE 30
NITICO 30
 OPTIMUM
 SE 45
 SE 45X
 NITICO 45
 SE 60
 SE 60X
 DN70 - SE 70
 SE GR
 TE 45
 PLUNGE -MILL
 THREAD MILL

Material Group | Material-Gruppe | Groupe Matière | Gruppo Materiali | 材质主类

Cutting Parameter

N01	N02	N03	K01	K02	P01	P02	P03	M01	M02	S01	S02	S03	H01	H02	O01	O02	142
-----	-----	-----	-----	-----	-----	-----	-----	-----	-----	-----	-----	-----	-----	-----	-----	-----	-----

NITICO 30 ENDMILLS, 3 FLUTES

- VHM NiTiCo 30 Fräser , 3 Zähne
- Frese NiTiCo 30, 3 taglienti
- Fraises NiTiCo 30 - 3 dents
- 整体硬质合金 NiTiCo 30 系列 2/3/4刀平底铣刀

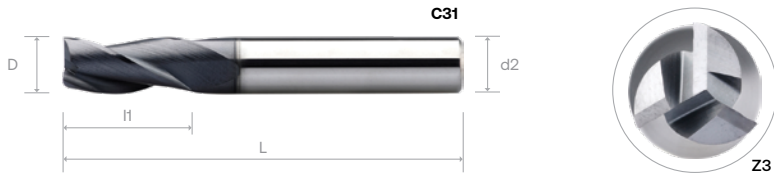
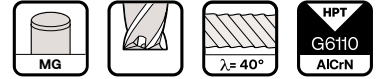

Order Number	Dimension (mm)					G6110
	D	I1	I2	L	d2 (h6)	
C31 0100 040 03	1	3		40	3	°
C31 0100 050 04				50	4	°
C31 0150 040 03	15	4.5		40	3	°
C31 0150 050 04				50	4	°
C31 0200 040 03 *	2	6.5		40	3	°
C31 0200 050 04				50	4	°
C31 0250 040 03	2.5	6.5		40	3	°
C31 0250 050 04				50	4	°
C31 0300	3	9		40	3	°
C31 0300 050 06				50	6	°
C31 0400	4	12		50	4	°
C31 0400 050 06				50	6	°
C31 0500	5	15		50	5	°
C31 0500 050 06				50	6	°
C31 0600 050	6	16		50	6	°
C31 0600 060			60	6	°	
C31 0800	8	20		64	8	°
C31 1000 070	10			70	10	°
C31 1000 075				75	10	°
C31 1200	12	25		75	12	°
C31 1400	14	32		90	14	°
C31 1600	16			90	16	°
C31 1800	18	38		100	18	°
C31 2000	20			100	20	°

* - DIN 6535

Material Group | Material-Gruppe | Groupe Matière | Gruppo Materiali | 材质主类

Cutting Parameter

N01	N02	N03	K01	K02	P01	P02	P03	M01	M02	S01	S02	S03	H01	H02	O01	O02	143
-----	-----	-----	-----	-----	-----	-----	-----	-----	-----	-----	-----	-----	-----	-----	-----	-----	-----

NITICO 30 ENDMILLS WITH WELDON, 2 FLUTES

- VHM NiTiCo 30 Fräser, mit Weldon, 2 Zähne
- Frese NiTiCo 30, con weldon, 2 taglienti
- Fraises NiTiCo 30 avec queue Weldon - 2 dents
- 整体硬质合金 NiTiCo 30 系列 4刃平底铣刀(侧固柄)

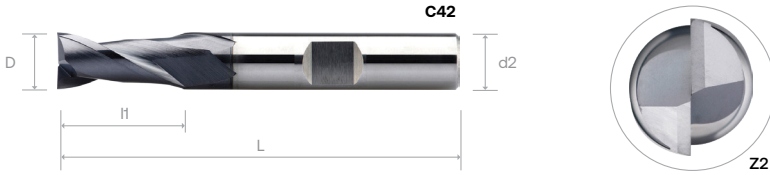

Order Number	Dimension (mm)					G6110
	D	l1	l2	L	d2 (h6)	
C42 0300 050 06	3	9		50	6	•
C42 0400 050 06	4	12		50	6	•
C42 0500 050 06	5	15		50	6	◦
C42 0600 050	6	16		50	6	◦
C42 0800	8	20		64	8	◦
C42 1000 070	10	22		70	10	◦
C42 1200	12	25		75	12	◦
C42 1400	14	32		90	14	◦
C42 1600	16		90	16	◦	
C42 1800	18	38		100	18	◦
C42 2000	20		100	20	◦	

- ALU LINE
- EZ LINE - ENDMILL
- SE 30
- NITICO 30
- OPTIMUM
- SE 45
- SE 45X
- NITICO 45
- SE 60
- SE 60X
- DM70 - SE 70
- SE GR
- TE 45
- PLUNGE -MILL
- THREAD MILL

Material Group | Material-Gruppe | Groupe Matière | Gruppo Materiali | 材质主类

N01
 N02
 N03
 K01
 K02
 P01
 P02
 P03
 M01
 M02
 S01
 S02
 S03
 H01
 H02
 O01
 O02

Cutting Parameter

142

NITICO 30 ENDMILLS WITH WELDON, 3 FLUTES

- VHM NiTiCo 30 Fräser, mit Weldon, 3 Zähne
- Frese NiTiCo 30, con weldon, 3 taglienti
- Fraises NiTiCo 30 av ec queue Weldon -3 dents
- 整体硬质合金 NiTiCo 30 系列 2/3/4刀平底铣刀(侧固柄)

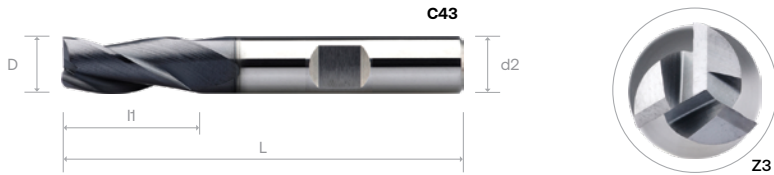

Order Number	Dimension (mm)					G6110
	D	l1	l2	L	d2 (h6)	
C43 0300 050 06	3	9		50	6	•
C43 0400 050 06	4	12		50	6	•
C43 0500 050 06	5	15		50	6	•
C43 0600 050	6	16		50	6	•
C43 0800	8	20		64	8	•
C43 1000 070	10	22		70	10	•
C43 1200	12	25		75	12	•
C43 1400	14	32		90	14	◦
C43 1600	16		90	16	•	
C43 1800	18	38		100	18	◦
C43 2000	20		100	20	•	

Material Group | Material-Gruppe | Groupe Matière | Gruppo Materiali | 材质主类

Cutting Parameter

N01	N02	N03	K01	K02	P01	P02	P03	M01	M02	S01	S02	S03	H01	H02	O01	O02	143
-----	-----	-----	-----	-----	-----	-----	-----	-----	-----	-----	-----	-----	-----	-----	-----	-----	-----

NITICO 30 ENDMILLS WITH WELDON, 4 FLUTES

- VHM NiTiCo 30 Fräser, mit Weldon, 4 Zähne
- Frese NiTiCo 30, con weldon, 4 taglianti
- Fraises NiTiCo 30 av ec queue Weldon - 4 dents
- 整体硬质合金 NiTiCo 30 系列 2/3/4刃平底铣刀(侧固柄)

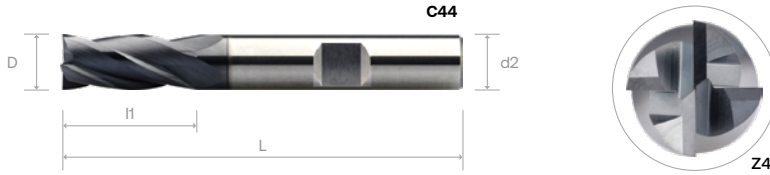

Order Number	Dimension (mm)					G6110
	D	l1	l2	L	d2 (h6)	
C44 0300 050 06	3	9		50	6	•
C44 0400 050 06	4	12		50	6	•
C44 0500 050 06	5	15		50	6	◦
C44 0600 050	6	16		50	6	◦
C44 0800	8	20		64	8	◦
C44 1000 070	10	22		70	10	◦
C44 1200	12	25		75	12	◦
C44 1400	14	32		90	14	◦
C44 1600	16			90	16	◦
C44 1800	18	38		100	18	◦
C44 2000	20			100	20	◦

- ALU LINE
- EZ LINE - ENDMILL
- SE 30
- NITICO 30
- OPTIMUM
- SE 45
- SE 45X
- NITICO 45
- SE 60
- SE 60X
- DM70 - SE 70
- SE GR
- TE 45
- PLUNGE -MILL
- THREAD MILL

Material Group | Material-Gruppe | Groupe Matiere | Gruppo Materiali | 材质主类

Cutting Parameter

N01	N02	N03	K01	K02	P01	P02	P03	M01	M02	S01	S02	S03	H01	H02	O01	O02	144
-----	-----	-----	-----	-----	-----	-----	-----	-----	-----	-----	-----	-----	-----	-----	-----	-----	-----

FEATURES & BENEFITS

NiTiCo DP



Top View

1 4 Flutes Design

- Significantly increased feedrate (25% over 3 flute)
- Optimised for slotting, side milling

2 Optimised Tool Geometry

Allows for improved shearing and decreased spindle loads

3 Positive Rake Angle

Enables smooth chip evacuation due to small size chips generated



4 Differential Pitch (DP)



- Provides excellent surface finishing while eliminating chatter

5 Stable Cutting Edge

Allows for high speeds and feed rates, greatly improving productivity

6 The Perfect Edge Design



- Provides a stable cutting edge with much reduced possibility of chipping while prolonging the tool life
- High CNC repeatability within 0.010mm

7 Suitable for Materials





1. 4-Schneiden-Design
Das 4-Schnitt-Design bietet gegenüber 3-Schnitt-Werkzeugen erhöhte Vorschubgeschwindigkeiten von bis zu 25 %
Für Nuten- und Umfangsfräsen
2. Optimierte Geometrie
Ermöglicht bessere Spanbildung und verringert die Spindelbelastungen
3. Positiver Spanwinkel
Ermöglicht eine gute Spanabfuhr durch kleine Späne
4. Ungleiche Teilung (DP)
Per una lavorazione senza vibrazione e finiture superficiali eccellenti
5. Stabile Schneide
Ermöglicht hohe Geschwindigkeiten und Vorschubgeschwindigkeiten, wodurch die Produktivität erheblich verbessert wird
6. Kleinstfase entlang der Schneiden
Eine optimale Schneidkantenpräparation ermöglicht eine stabile Schneidkante und sorgt für einen gleichmäßigen und kontrollierten Verschleiß. Dadurch wird ebenfalls die Standzeit optimiert und Ermöglicht hohe Geschwindigkeiten und Vorschübe und verbessert die Produktivität.
Ermöglicht hohe CNC-Wiederholbarkeit innerhalb 0,01mm
7. Geeignet für die Materialgruppen P, M, K, S



1. 4刃设计
4个设计大师, 进给率提高到25%超过3种工具。
可以用于开槽和侧铣。
2. 优化的刀具几何形状
允许改善剪切并减少主轴负载。
3. 正前角
尺寸小, 排屑顺畅 产生的筹码。
4. 不等分割设计 (DP)
有效降低加工时的振动从而, 达到更好的工件表面光洁度。
5. 稳定的切削刃
允许高速和进给率, 大大提高生产率。
6. 发线边刃
提供稳定的切削刃, 大大降低崩刃的可能性, 同时延长刀具寿命。
7. 适用于材料 P、M、K、S







1. Design a 4 flauti
Il design a 4 taglienti garantisce un avanzamento del 25% superiore rispetto alle frese Z3 e può essere usato
2. Geometria utensile ottimizzata
Consente di migliorare la cesoiatura e di ridurre i carichi sul mandrino
3. Angolo di spoglia positivo
Consente un'evacuazione del truciolo senza intoppi grazie alle piccole dimensioni dei trucioli generati
4. Design del passo differenziale (DP)
Design del passo differenziale (DP) Riduce le vibrazioni, massimizza la produttività e la durata dell'utensile.
5. Boardo di taglio stabile
Consente velocità e velocità di avanzamento elevate, migliorando notevolmente la produttività
6. Il design del bordo prefetto
Fornisce un bordo di taglio stabile con molto ridotta possibilità di scheggiatura mentre prolungare la vita dell'utensile
ridotta possibilità di scheggiatura mentre prolungare la vita dell'utensile
7. Adatto per materiali P, M, K, S



1. Conception à 4 Goujures
La conception à 4 dents offre des vitesses d'avance accrues jusqu'à 25 % par rapport aux outils à 3 dents et peut être utilisée dans
Pour le rainurage et le contourage
2. Géométrie de L'outil Optimisée
Permet un cisaillement amélioré et des charges diminuées sur l'allonge
3. Angle de coupe Positif
Permet une évacuation des copeaux fluide en raison de la petite taille des copeaux générés
4. Conception à pas différentiel (DP)
Pour un usinage sans vibrations et un très bon état de surface
5. Bord de coupe stable
Permet des vitesses et des vitesses d'avance élevées améliorant considérablement la productivité
6. Marge de craquelure
Fournit un tranchant stable avec beaucoup possibilité réduite d'écaillage en prolongeant la durée de vie de l'outil
Très bonne répétabilité de l'usinage sur cnc à moins de 0,010 mm
7. Adapté aux matériaux P, M, K, S

NITICO 30 DP ENDMILLS / WITH WELDON, 4 FLUTES

-  VHM NiTiCo 30 DP Fräser, 4 Zähne
-  Frese NiTiCo 30, con passo differenziale, 4 taglienti
-  Fraises NiTiCo 30 DP à pas décalés, 4 dents
-  整体硬质合金 NiTiCo 30 DP 系列 4 刀平底铣刀



Order Number	Dimension (mm)						HA G6110	Order Number	Dimension (mm)						HB G6110
	D	I1	I2	L	d2 (h6)				D	I1	I2	L	d2 (h6)		
951 0300 040 03	3	9		40	3	•	972 0300 040 03	3	9		40	3			
951 0300 040 04			40	4	•	972 0300 040 04	40			4					
951 0300 050 06			50	6	•	972 0300 050 06	50			6	◦				
951 0300 057 06				57	6	•	972 0300 057 06				57	6	◦		
951 0400 050 04	4	12		50	4	•	972 0400 050 04	4	12		50	4			
951 0400 050 06			50	6	•	972 0400 050 06	50			6	◦				
951 0400 057 06			57	6	•	972 0400 057 06	57			6	◦				
951 0500 050 05	5	13		50	5	•	972 0500 050 05	5	13		50	5			
951 0500 050 06			50	6	•	972 0500 050 06	50			6	◦				
951 0500 057 06			57	6	•	972 0500 057 06	57			6	◦				
951 0600 050	6	13		50	6	•	972 0600 050	6	13		50	6	◦		
951 0600 057			57	6	•	972 0600 057	57			6	•				
951 0800 064			8	20		64	8			•	972 0800 064	8	20		64
951 1000 070	10	22		70	10	•	972 1000 070	10	22		70	10			
951 1000 072			72	10	•	972 1000 072	72			10	•				
951 1000 075			75	10	•	972 1000 075	75			10	◦				
951 1200 075	12	26		75	12	•	972 1200 075	12	26		75	12			
951 1200 083			83	12	•	972 1200 083	83			12	•				
951 1400 083			83	14	•	972 1400 083	83			14	•				
951 1400 090	14	32		90	14	•	972 1400 090	14	32		90	14			
951 1600 090			90	16	•	972 1600 090	90			16	◦				
951 1600 092			92	16	•	972 1600 092	92			16	•				
951 1800 092	18	38		92	18	•	972 1800 092	18	38		92	18			
951 1800 100			100	18	•	972 1800 100	100			18	◦				
951 2000 100			100	20	•	972 2000 100	100			20	•				
951 2000 104	20			104	20	•	972 2000 104	20			104	20	◦		

* - DIN 6535

CNC Repeatability

Ø1 - Ø3 within 10µm
Ø4 - Ø8 within 15µm
≥ Ø10 within 20µm

Material Group | Material-Gruppe | Groupe Matière | Gruppo Materiali | 材质主类

Cutting Parameter

N01	N02	N03	K01	K02	P01	P02	P03	M01	M02	S01	S02	S03	H01	H02	O01	O02	145 - 146
-----	-----	-----	-----	-----	-----	-----	-----	-----	-----	-----	-----	-----	-----	-----	-----	-----	-----------

NITICO 30 DP TORUS ENDMILLS / WITH WELDON, 4 FLUTES

- VHM NiTiCo 30 DPR Torusfräser, 4 Zähne
- Frese toroidali NiTiCo 30, con passo differenziale, 4 taglienti
- Fraises NiTiCo 30 DP toriques à pas décalés, 4 dents
- 整体硬质合金 NiTiCo 30 DPR 系列 4刃圆鼻铣刀

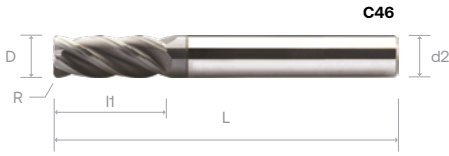
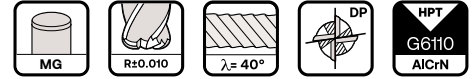

Order Number	Dimension (mm)						HA	Order Number	Dimension (mm)						HB	
	D	I1	I2	L	d2 (h6)	R			G6110	D	I1	I2	L	d2 (h6)		R
C46 0300 040 0300 030	3	9		40	3	0.3	•	C52 0300 040 0300 030	3	9		40	3	0.3	-	C52 0300 040 0300 050
C46 0300 040 0300 050				40	3	0.5	•	C52 0300 040 0300 050								
C46 0300 040 0400 030				40	4	0.3	◦	C52 0300 040 0400 030								
C46 0300 040 0400 050				40	4	0.5	•	C52 0300 040 0400 050								
C46 0300 050 0600 030				50	6	0.3	◦	C52 0300 050 0600 030								
C46 0300 050 0600 050				50	6	0.5	•	C52 0300 050 0600 050								
C46 0300 057 0600 030			57	6	0.3	•	C52 0300 057 0600 030									
C46 0300 057 0600 050			57	6	0.5	•	C52 0300 057 0600 050									
C46 0400 050 0400 030		4	12		50	4	0.3	•		C52 0400 050 0400 030						
C46 0400 050 0400 050					50	4	0.5	•		C52 0400 050 0400 050						
C46 0400 050 0400 100					50	4	1	•		C52 0400 050 0400 100						
C46 0400 050 0600 030					50	6	0.3	•		C52 0400 050 0600 030						
C46 0400 050 0600 050				50	6	0.5	•	C52 0400 050 0600 050								
C46 0400 050 0600 100				50	6	1	•	C52 0400 050 0600 100								
C46 0400 057 0600 030			57	6	0.3	•	C52 0400 057 0600 030									
C46 0400 057 0600 050			57	6	0.5	•	C52 0400 057 0600 050									
C46 0400 057 0600 100			57	6	1	◦	C52 0400 057 0600 100									
C46 0500 050 0500 030	5		15		50	5	0.3	•	C52 0500 050 0500 030							
C46 0500 050 0500 050					50	5	0.5	•	C52 0500 050 0500 050							
C46 0500 050 0500 100					50	5	1	•	C52 0500 050 0500 100							
C46 0500 050 0600 030				50	6	0.3	•	C52 0500 050 0600 030								
C46 0500 050 0600 050				50	6	0.5	•	C52 0500 050 0600 050								
C46 0500 050 0600 100				50	6	1	•	C52 0500 050 0600 100								
C46 0500 057 0600 030			57	6	0.3	•	C52 0500 057 0600 030									
C46 0500 057 0600 050			57	6	0.5	•	C52 0500 057 0600 050									
C46 0600 050 0600 030		6	16		50	6	0.3	•	C52 0600 050 0600 030							
C46 0600 050 0600 050					50	6	0.5	•	C52 0600 050 0600 050							
C46 0600 050 0600 100					50	6	1	◦	C52 0600 050 0600 100							
C46 0600 057 0600 030					57	6	0.3	•	C52 0600 057 0600 030							
C46 0600 057 0600 050				57	6	0.5	•	C52 0600 057 0600 050								
C46 0600 057 0600 100				57	6	1	◦	C52 0600 057 0600 100								
C46 0600 060 0600 030			60	6	0.3	◦	C52 0600 060 0600 030									
C46 0600 060 0600 050			60	6	0.5	•	C52 0600 060 0600 050									
C46 0600 060 0600 100			60	6	1	◦	C52 0600 060 0600 100									
C46 0800 064 0800 030	8		20		64	8	0.3	•	C52 0800 064 0800 030							
C46 0800 064 0800 050					64	8	0.5	•	C52 0800 064 0800 050							
C46 0800 064 0800 100					64	8	1	•	C52 0800 064 0800 100							
C46 0800 064 0800 150				64	8	1.5	•	C52 0800 064 0800 150								
C46 0800 064 0800 200				64	8	2	•	C52 0800 064 0800 200								
C46 1000 070 1000 030		10		22		70	10	0.3	•	C52 1000 070 1000 030						
C46 1000 070 1000 050					70	10	0.5	•	C52 1000 070 1000 050							
C46 1000 070 1000 100					70	10	1	•	C52 1000 070 1000 100							
C46 1000 070 1000 150					70	10	1.5	•	C52 1000 070 1000 150							
C46 1000 070 1000 200					70	10	2	•	C52 1000 070 1000 200							
C46 1000 072 1000 030					72	10	0.3	•	C52 1000 072 1000 030							
C46 1000 072 1000 050				72	10	0.5	•	C52 1000 072 1000 050								
C46 1000 072 1000 100			72	10	1	•	C52 1000 072 1000 100									
C46 1000 075 1000 030			75	10	0.3	•	C52 1000 075 1000 030									
C46 1000 075 1000 050			75	10	0.5	•	C52 1000 075 1000 050									
C46 1000 075 1000 100			75	10	1	•	C52 1000 075 1000 100									
C46 1000 075 1000 150			75	10	1.5	•	C52 1000 075 1000 150									
C46 1000 075 1000 200		75	10	2	•	C52 1000 075 1000 200										
C46 1200 075 1200 030	12	25		75	12	0.3	•	C52 1200 075 1200 030								
C46 1200 075 1200 050				75	12	0.5	•	C52 1200 075 1200 050								
C46 1200 075 1200 100				75	12	1	•	C52 1200 075 1200 100								
C46 1200 075 1200 150				75	12	1.5	•	C52 1200 075 1200 150								
C46 1200 075 1200 200				75	12	2	•	C52 1200 075 1200 200								

ALU LINE
 EZ LINE - ENDMILL
 SE 30
NITICO 30
 OPTIMUM
 SE 45
 SE 45X
 NITICO 45
 SE 60
 SE 60X
 DN70 - SE70
 SE GR
 TE 45
 PLUNGE -MILL
 THREAD MILL

CNC Repeatability
 Ø1 - Ø3 within 10µm
 Ø4 - Ø8 within 15µm
 ≥ Ø10 within 20µm

Material Group | Material-Gruppe | Groupe Matiere | Gruppo Materiali | 材质主类

N01
N02
N03
K01
K02
P01
P02
P03
M01
M02
S01
S02
S03
H01
H02
O01
O02

Cutting Parameter
 145 - 146

NITICO 30 DP TORUS ENDMILLS / WITH WELDON, 4 FLUTES

- VHM NiTiCo 30 DPR Standard Torusfräser, 4 Zähne
- Frese toroidali NiTiCo 30, con passo differenziale, 4 taglienti
- Fraises NiTiCo 30 DP toriques à pas décalés, 4 dents
- 整体硬质合金 NiTiCo 30 DPR 系列 4刃圆鼻铣刀

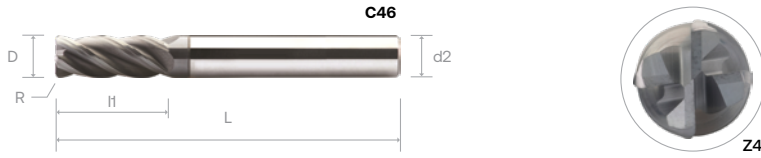

Order Number	Dimension (mm)						HA	Order Number	Dimension (mm)						HB			
	D	I1	I2	L	d2 (h6)	R			G6110	D	I1	I2	L	d2 (h6)		R	G6110	
C46 1200 075 1200 250	12	25		75	12	2.5	•	C52 1200 075 1200 250	12	25		75	12	2.5	◦			
C46 1200 075 1200 300				75	12	3	•	C52 1200 075 1200 300				75	12	3	◦			
C46 1200 083 1200 030				83	12	0.3	•	C52 1200 083 1200 030				83	12	0.3	◦			
C46 1200 083 1200 050		26			83	12	0.5	•		C52 1200 083 1200 050		26		83	12	0.5	◦	
C46 1200 083 1200 100					83	12	1	•		C52 1200 083 1200 100				83	12	1	◦	
C46 1200 083 1200 200					83	12	2	•		C52 1200 083 1200 200				83	12	2	◦	
C46 1200 083 1200 250					83	12	2.5	◦		C52 1200 083 1200 250				83	12	2.5	◦	
C46 1200 083 1200 300					83	12	3	•		C52 1200 083 1200 300				83	12	3	◦	
C46 1400 083 1400 030					14		83	14		0.3				•	C52 1400 083 1400 030	14		83
C46 1400 083 1400 050		83		14			0.5	◦		C52 1400 083 1400 050		83	14	0.5	◦			
C46 1400 083 1400 100		83		14			1	◦		C52 1400 083 1400 100		83	14	1	◦			
C46 1400 083 1400 150		83		14			1.5	◦		C52 1400 083 1400 150		83	14	1.5	◦			
C46 1400 083 1400 200	83	14	2	◦			C52 1400 083 1400 200	83	14	2	◦							
C46 1400 083 1400 300	83	14	3	◦			C52 1400 083 1400 300	83	14	3	◦							
C46 1400 090 1400 050	90	14	0.5	◦			C52 1400 090 1400 050	90	14	0.5	◦							
C46 1400 090 1400 100	90	14	1	◦			C52 1400 090 1400 100	90	14	1	◦							
C46 1400 090 1400 150	90	14	1.5	◦			C52 1400 090 1400 150	90	14	1.5	◦							
C46 1400 090 1400 200	90	14	2	◦			C52 1400 090 1400 200	90	14	2	◦							
C46 1400 090 1400 300	90	14	3	•			C52 1400 090 1400 300	90	14	3	◦							
C46 1600 090 1600 050	16	32	90	16			0.5	•	C52 1600 090 1600 050	16	32	90	16	0.5	◦			
C46 1600 090 1600 100			90	16	1	•	C52 1600 090 1600 100	90	16			1	◦					
C46 1600 090 1600 150			90	16	1.5	•	C52 1600 090 1600 150	90	16			1.5	◦					
C46 1600 090 1600 200			90	16	2	•	C52 1600 090 1600 200	90	16			2	◦					
C46 1600 090 1600 250			90	16	2.5	•	C52 1600 090 1600 250	90	16			2.5	◦					
C46 1600 090 1600 300			90	16	3	•	C52 1600 090 1600 300	90	16			3	•					
C46 1600 090 1600 400			90	16	4	•	C52 1600 090 1600 400	90	16			4	◦					
C46 1600 092 1600 030			92	16	0.3	•	C52 1600 092 1600 030	92	16			0.3	◦					
C46 1600 092 1600 050			92	16	0.5	◦	C52 1600 092 1600 050	92	16			0.5	◦					
C46 1600 092 1600 100			92	16	1	•	C52 1600 092 1600 100	92	16			1	◦					
C46 1600 092 1600 200			92	16	2	◦	C52 1600 092 1600 200	92	16			2	◦					
C46 1600 092 1600 250			92	16	2.5	◦	C52 1600 092 1600 250	92	16			2.5	◦					
C46 1600 092 1600 300	92	16	3	◦	C52 1600 092 1600 300	92	16	3	◦									
C46 1600 092 1600 400	92	16	4	•	C52 1600 092 1600 400	92	16	4	◦									
C46 1800 092 1800 030	18		92	18	0.3	◦	C52 1800 092 1800 030	18		92	18	0.3	◦					
C46 1800 092 1800 050			92	18	0.5	◦	C52 1800 092 1800 050			92	18	0.5	◦					
C46 1800 092 1800 100			92	18	1	◦	C52 1800 092 1800 100			92	18	1	◦					
C46 1800 092 1800 200			92	18	2	◦	C52 1800 092 1800 200			92	18	2	◦					
C46 1800 092 1800 300			92	18	3	◦	C52 1800 092 1800 300			92	18	3	◦					
C46 1800 100 1800 050			100	18	0.5	◦	C52 1800 100 1800 050			100	18	0.5	◦					
C46 1800 100 1800 100			100	18	1	◦	C52 1800 100 1800 100			100	18	1	◦					
C46 1800 100 1800 150			100	18	1.5	◦	C52 1800 100 1800 150			100	18	1.5	◦					
C46 1800 100 1800 200			100	18	2	•	C52 1800 100 1800 200			100	18	2	◦					
C46 1800 100 1800 300			100	18	3	◦	C52 1800 100 1800 300			100	18	3	◦					
C46 2000 100 2000 050			20	38	100	20	0.5			•	C52 2000 100 2000 050	20	38	100	20	0.5	◦	
C46 2000 100 2000 100					100	20	1			•	C52 2000 100 2000 100			100	20	1	◦	
C46 2000 100 2000 150	100	20			1.5	•	C52 2000 100 2000 150	100	20	1.5	◦							
C46 2000 100 2000 200	100	20			2	•	C52 2000 100 2000 200	100	20	2	◦							
C46 2000 100 2000 250	100	20			2.5	◦	C52 2000 100 2000 250	100	20	2.5	◦							
C46 2000 100 2000 300	100	20			3	•	C52 2000 100 2000 300	100	20	3	◦							
C46 2000 100 2000 400	100	20			4	◦	C52 2000 100 2000 400	100	20	4	◦							
C46 2000 104 2000 030	104	20			0.3	◦	C52 2000 104 2000 030	104	20	0.3	◦							
C46 2000 104 2000 050	104	20			0.5	•	C52 2000 104 2000 050	104	20	0.5	◦							
C46 2000 104 2000 100	104	20			1	◦	C52 2000 104 2000 100	104	20	1	◦							
C46 2000 104 2000 200	104	20			2	◦	C52 2000 104 2000 200	104	20	2	◦							
C46 2000 104 2000 250	104	20			2.5	•	C52 2000 104 2000 250	104	20	2.5	◦							
C46 2000 104 2000 300	104	20	3	•	C52 2000 104 2000 300	104	20	3	•									
C46 2000 104 2000 400	104	20	4	•	C52 2000 104 2000 400	104	20	4	◦									

CNC Repeatability
 Ø1 - Ø3 within 10µm
 Ø4 - Ø8 within 15µm
 ≥ Ø10 within 20µm

Material Group | Material-Gruppe | Groupe Matière | Gruppo Materiali | 材质主类

Cutting Parameter

N01	N02	N03	K01	K02	P01	P02	P03	M01	M02	S01	S02	S03	H01	H02	O01	O02	145 - 146
-----	-----	-----	-----	-----	-----	-----	-----	-----	-----	-----	-----	-----	-----	-----	-----	-----	-----------



NITICO 30 DH ENDMILLS / WITH WELDON, 5 FLUTES

- VHM NiTiCo 30 DH Fräser, lang, 5 Zähne
- Frese NiTiCo 30, con elica v ariabile, 5 taglienti
- Fraises NiTiCo 30 DH à pas décalés, 5 dents
- 整体硬质合金 NiTiCo 30 DH 系列 5刃长型平底铣刀



* A small radius similar to torus

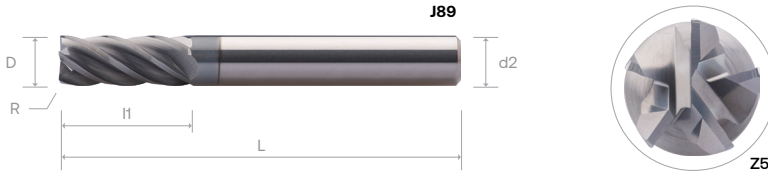

Order Number	Dimension (mm)							HA	Order Number	Dimension (mm)							HB
	D	I1	I2	L	d2 (h6)	R	G6110			D	I1	I2	L	d2 (h6)	R	G6110	
J89 0400 057 06	4	12		57	6	0.1	•	J90 0400 057 06	4	12		57	6	0.1	◦		
J89 0500 057 06	5	13		57	6	0.1	•	J90 0500 057 06	5	13		57	6	0.1	•		
J89 0600 057	6			57	6	0.1	•	J90 0600 057	6			57	6	0.1	•		
J89 0800 064	8	20		64	8	0.2	•	J90 0800 064	8	20		64	8	0.2	•		
J89 1000 072	10	22		72	10	0.2	•	J90 1000 072	10	22		72	10	0.2	•		
J89 1200 083	12	26		83	12	0.3	•	J90 1200 083	12	26		83	12	0.3	◦		
J89 1600 092	16	32		92	16	0.3	•	J90 1600 092	16	32		92	16	0.3	◦		
J89 2000 104	20	38		104	20	0.3	•	J90 2000 104	20	38		104	20	0.3	◦		

ALU LINE
 EZ LINE - ENDMILL
 SE 30
NITICO 30
 OPTIMUM
 SE 45
 SE 45X
 NITICO 45
 SE 60
 SE 60X
 DN70 - SE 70
 SE GR
 TE 45
 PLUNGE -MILL
 THREAD MILL

CNC Repeatability
Ø1 - Ø3 within 10µm
Ø4 - Ø8 within 15µm
≥ Ø10 within 20µm





Material Group | Material-Gruppe | Groupe Matière | Gruppo Materiali | 材质主类



Cutting Parameter

146 - 147

NITICO 30 DH LONG ENDMILLS / WITH WELDON, 5 FLUTES

-  VHM NiTiCo 30 DH Fräser, lang, 5 Zähne
-  Frese lunghe NiTiCo 30, con elica v variabile, 5 taglienti
-  Fraises NiTiCo 30 DH Long à pas décalés, 5 dents
-  整体硬质合金 NiTiCo 30 DH 系列 5刃长型平底铣刀



* A small radius similar to torus

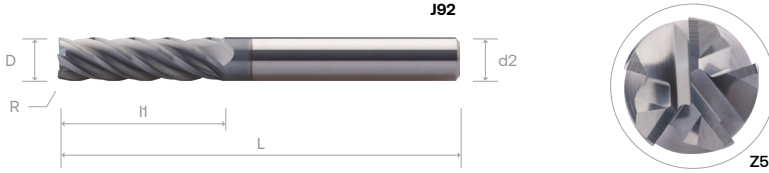

Order Number	Dimension (mm)							HA	Order Number	Dimension (mm)							HB
	D	I1	I2	L	d2 (h6)	R	G6110			D	I1	I2	L	d2 (h6)	R	G6110	
J92 0600 075	6	25		75	6	0.1	•	J93 0600 075	6	25		75	6	0.1	•		
J92 0800 075	8			75	8	0.2	•	J93 0800 075	8			75	8	0.2	•		
J92 1000 100	10	38		100	10	0.2	•	J93 1000 100	10	38		100	10	0.2	•		
J92 1200 100	12	45		100	12	0.3	•	J93 1200 100	12	45		100	12	0.3	•		
J92 1600 125	16	55		125	16	0.3	•	J93 1600 125	16	55		125	16	0.3	•		
J92 2000 125	20	65		125	20	0.3	•	J93 2000 125	20	65		125	20	0.3	•		

CNC Repeatability

- Ø1 - Ø3 within 10µm
- Ø4 - Ø8 within 15µm
- ≥ Ø10 within 20µm

Material Group | Material-Gruppe | Groupe Matière | Gruppo Materiali | 材质主类

Cutting Parameter

N01	N02	N03	K01	K02	P01	P02	P03	M01	M02	S01	S02	S03	H01	H02	O01	O02	147
-----	-----	-----	-----	-----	-----	-----	-----	-----	-----	-----	-----	-----	-----	-----	-----	-----	-----

FEATURES & BENEFITS

NiTiCo DH 5F



Top View

1 5 Flutes Design

The 5 flute design offers increased feed rates up to 25% over 4 flute tools and can be used in slotting, profiling and semi-finishing applications.

3 Differential Helix (DH)



- Reduces machining vibrations allowing for high speed machining and increased productivity
- For chatter free machining and excellent surface finishing

5 Oil Hole for High Performance Milling



- Improves welding resistance
- Enables a wide range of machining processes
- Especially beneficial for difficult to cut materials, offering stable machining

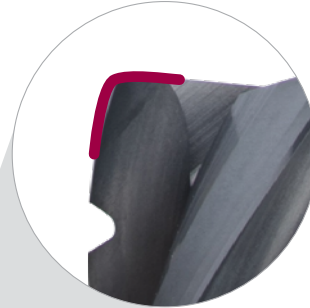

2 Small Corner Radius

For less chipping of the cutting edges and longer tool life.

4 Ideal Cutting Edge

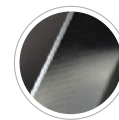

Provide edge protection to prolong tool life

6 Optimized Geometry with Chipbreakers

Efficiently shears work materials and shortens chips for improved chips removal.





1. 5 Flöten-Design
Das 5-Schnitt-Design bietet gegenüber 4-Schnitt-Werkzeugen erhöhte Vorschubgeschwindigkeiten von bis zu 25 %
kann beim Schlitzten, Profilieren und Vorschlichten verwendet werden.
2. Kleiner Eckenradius
Für weniger Ausbrüche der Schneidkanten und längere Standzeiten.
3. Ungleiche Drallsteigung (DH)
Reduziert Bearbeitungsvibrationen und ermöglicht eine Hochgeschwindigkeitsbearbeitung und eine höhere Produktivität
Zur Schnittkraftreduzierung und Leistungssteigerung
4. Perfekte Schneide
Bietet Schneidkantenschutz, um die Lebensdauer des Werkzeugs zu verlängern
5. Große Kühlkanalbohrungen für Hochleistungsfräsen
Verbessert die Spanabfuhr
Ermöglicht umfangreiche Applikationen
Große Vorteile für die Bearbeitung festerer Aluminiumlegierungen XQ
6. Spanbrechergeometrie
Erzeugt kontrollierte, kurze Späne



1. 5个设计大师
进给率提高到25%超过4种工具。
可以用于开槽, 轮廓和半成品应用程序。
2. 小角半径
减少切削刃刀口和更长的刀具寿命。
3. 不等距螺旋设计 (DH)
减少切削阻力, 提高机械加工性能。
用于无颤振加工和出色的表面光洁度。
4. 理想的切削刃
提供边缘保护延长刀具寿命。
5. 高性能油孔
切削时更能达到冷却的效果。
降低积屑的效果从而更优。
化排屑性能。
6. 使用断屑槽优化几何
高效剪切工作材料并缩短切屑以改善排屑。



1. Design a 5 taglienti
Il design a 5 taglienti garantisce un avanzamento del 25% superiore rispetto alle frese Z4 e può essere usato per cave dal pieno, profilatura e operazioni di semifinitura.
2. Tagliente leggermente raggiato
Riduce le scheggiature del tagliente garantendo una vita utensile più lunga.
3. Elica variabile (DH)
Per lavorazioni senza vibrazioni e ottime finiture superficiali
4. Preparazione del tagliente ideale e prolungamento della vita utensile.
5. Fori di lubrorefrigerazione
Consentono una vasta gamma di processi di lavorazione.
Particolarmente vantaggioso su materiali difficili da lavorare garantendo stabilità nella lavorazione.
6. Geometria ottimizzata
Riduce la lunghezza dei trucioli consentendone una migliore evacuazione.



1. Conception de 5 flûtes
les applications de rainurage, de profilage et de semi-finition.
2. Petit rayon d'angle
Pour moins d'écaillage des arêtes de coupe et une plus longue durée de vie de l'outil.
3. Conception à hélice variable
Réduit les efforts de coupes et améliore les performances d'usinage
Pour un usinage sans bavardage et un excellent état de surface
4. Arête tranchante idéale
Protège les arêtes pour prolonger la durée de vie de l'outil
5. Trou d'huile pour le fraisage haute performance
Améliore la résistance au soudage
Permet une large gamme de processus d'usinage
Particulièrement bénéfique pour les matériaux difficiles à couper, offrant un usinage stable
6. Géométrie optimisée avec brise-copeaux
Cisaille efficacement les matériaux de travail et raccourcit les copeaux pour une meilleure élimination des copeaux.



K65 NEW



NITICO 30 DH ENDMILLS, WITH INTERNAL OIL HOLE, CHIP BREAKER, RECESS AND WELDON, 5 FLUTES

VHM NiTiCo 30 DH Standard Fräser, lang, mit Spanbrecher, Freistellung und Weldon, 5 Zähne

Frese NiTiCo 30, con elica differenziale, rompitrucciolo, foro lubrificante interno, recesso e weldon, 5 taglienti

Fraises NiTiCo 30 DH Standard à pas décalés av ec hélice différentielle, brise-copeaux, év idement et Weldon , 5 dents

整体硬质合金 NiTiCo 30 DH 系列 5刃平底铣刀(断屑槽、避空位和侧固柄)

* A small radius similar to torus

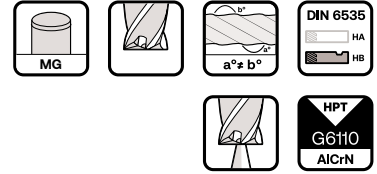
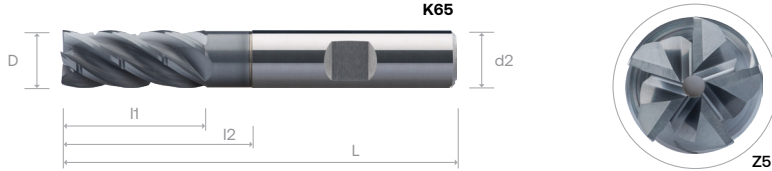

Order Number DIN 6535	Dimension (mm)						G6110
	D	l1	l2	L	d2 (h6)	R	
K65 0400 057 06	4	10	15	57	6	0.1	•
K65 0600 057 *	6	15	20	57	6	0.1	•
K65 0800 064	8	20	25	64	8	0.15	•
K65 1000 072 *	10	25	30	72	10	0.2	•
K65 1200 083 *	12	30	38	83	12	0.2	•
K65 1600 092 *	16	39	44	92	16	0.3	•
K65 2000 104 *	20	48	54	104	20	0.3	•

* - DIN 6535

CNC Repeatability
Ø1 - Ø3 within 10µm
Ø4 - Ø8 within 15µm
≥ Ø10 within 20µm

Material Group | Material-Gruppe | Groupe Matière | Gruppo Materiali | 材质主类



Cutting Parameter

148 - 149

ALU LINE
EZ LINE -
ENDMILL
SE 30
NITICO 30
OPTIMUM
SE 45
SE 45X
NITICO 45
SE 60
SE 60X
DM70 -
SE 70
SE GR
TE 45
PLUNGE
-MILL
THREAD
MILL



NITICO 30 DH LONG ENDMILLS, WITH INTERNAL OIL HOLE, CHIP BREAKER, RECESS AND WELDON 5 FLUTES

- VHM NiTiCo 30 DH Fräser, lang, mit Spanbrecher, Freistellung und Weldon, 5 Zähne
- Frese lunghe NiTiCo 30, con elica v variabile, rompitruciolo, foro lubrificante interno, recesso e weldon, 5 taglienti
- Fraises NiTiCo 30 DH Long à pas décalés av ec hélice différentielle, brise-copeaux, év idement et Weldon , 5 dents
- 整体硬质合金 NiTiCo 30 DH 系列 5刃长型平底铣刀(断屑槽、避空位和侧固柄)

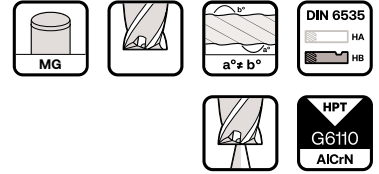

* A small radius similar to torus

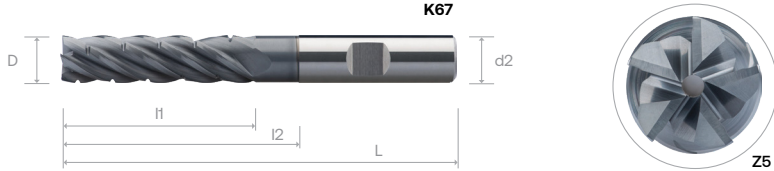

Order Number DIN 6535	Dimension (mm)						G610
	D	I 1	I 2	L	d2 (h6)	R	
K67 0600 075	6	26	32	75	6	0.1	•
K67 0800 075 *	8	32	38	75	8	0.2	•
K67 1000 100	10	42	52	100	10	0.2	•
K67 1200 100 *	12		54	100	12	0.2	•
K67 1600 125	16	60	68	125	16	0.3	•
K67 2000 125 *	20	67	75	125	20	0.3	•

* - DIN 6535

CNC Repeatability

Ø1 - Ø3 within 10µm
Ø4 - Ø8 within 15µm
≥ Ø10 within 20µm

Material Group | Material-Gruppe | Groupe Matière | Gruppo Materiali | 材质主类

Cutting Parameter

N01	N02	N03	K01	K02	P01	P02	P03	M01	M02	S01	S02	S03	H01	H02	O01	O02	149
-----	-----	-----	-----	-----	-----	-----	-----	-----	-----	-----	-----	-----	-----	-----	-----	-----	-----

FEATURES & BENEFITS

NiTiCo DP/DH

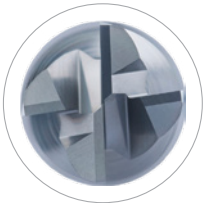

Top View

1 Differential Helix (DH)



- Reduces machining vibrations allowing for high speed machining and increased productivity
- For chatter free machining and excellent surface finishing

3 Differential Pitch (DP)



- Provides excellent surface finishing while eliminating chatter

5 Stable Cutting Edge

Allows for high speeds and feed rates greatly improving productivity

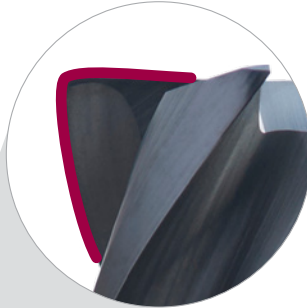

4 Corner Radius



- Reducing chipping and providing longer tool life
- Standardized corner radius for aerospace components

2 The Perfect Edge Design

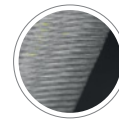

- Provides a stable cutting edge with much reduced possibility of chipping while prolonging the tool life
- High CNC repeatability within 0.010mm

6 Suitable for Materials





1. Ungleiche Drallsteigung (DH)
Reduziert Bearbeitungsvibrationen und ermöglicht eine Hochgeschwindigkeitsbearbeitung und eine höhere Produktivität
Zur Schnittkraftreduzierung und Leistungssteigerung
2. Kleinstfase entlang der Schneiden
Eine optimale Schneidkantenpräparation ermöglicht eine stabile Schneidkante und sorgt für einen gleichmäßigen und kontrollierten Verschleiß. Dadurch wird ebenfalls die Standzeit optimiert und Ermöglicht hohe Geschwindigkeiten und Vorschübe und verbessert die Produktivität.
Ermöglicht hohe CNC-Wiederholbarkeit innerhalb 0,01mm
3. Ungleiche Teilung (DP)
Per una lavorazione senza vibrazione e finiture superficiali eccellenti
4. Eckenradius
Eckenradiushervorragender Schneideckenschutz sorgt für längere Werkzeuglebensdauer genormte Eckenradien für Aerospace Bauteile• Standardisierter Eckradius für Aerospace-Komponenten (XQ Alu)
5. Stabile Schneide
Ermöglicht hohe Geschwindigkeiten und Vorschubgeschwindigkeiten, wodurch die Produktivität erheblich verbessert wird
6. Geeignet für die Materialgruppen P, M, K, S



1. 不等距螺旋设计 (DH)
减少切削阻力,提高机械加工性能。
用于无颤振加工和出色的表面光洁度。
2. 发线边刃
提供稳定的切削刃,大大降低崩刃的可能性,同时延长刀具寿命。
3. 不等分割设计 (DP)
有效降低加工时的振动从而,达到更好的工件表面光洁度。
4. 拐角半径
减少碎屑并延长刀具寿命。
航空航天部件的标准化圆角半径 (XQ Alu)。
5. 稳定的切削刃
允许高速和进给率,大大提高生产率。
6. 适用于材料 P、M、K、S



1. Elica differenziale (DH)
Riduce le vibrazioni di lavorazione, consentendo di lavorazioni ad alta velocità e maggiore produttività
Per ridurre le forze di taglio e migliorare le performance di lavorazione
2. Il design del bordo prefetto
Fornisce un bordo di taglio stabile con molto ridotta possibilità di scheggiatura mentre prolungare la vita dell'utensile
ridotta possibilità di scheggiatura mentre prolungare la vita dell'utensile
3. Design del passo differenziale (DP)
Design del passo differenziale (DP) Riduce le vibrazioni, massimizza la produttività e la durata dell'utensile.
4. Raggio d'angolo
Riduzione dei trucioli e maggiore durata dell'utensile
Raggio d'angolo standardizzato per componenti aerospaziali (XQ Alu)
5. Boardo di taglio stabile
Consente velocità e velocità di avanzamento elevate, migliorando notevolmente la produttività
6. Adatto per il materiale P, M, K, S



1. Conception à hélice variable
Réduit les efforts de coupes et améliore les performances d'usinage
Pour un usinage sans bavardage et un excellent état de surface
2. Marge de craquelure
Fournit un tranchant stable avec beaucoup possibilité réduite d'écaillage en prolongeant la durée de vie de l'outil
Très bonne répétabilité de l'usinage sur cnc à moins de 0,010 mm
3. Conception à pas différentiel (DP)
Pour un usinage sans vibrations et un très bon état de surface
4. Rayon d'angle
Réduire l'écaillage et prolonger la durée de vie de l'outil
Rayon d'angle normalisé pour les composants aérospatiaux (XQ Alu)
5. Bord de coupe stable
Permet des vitesses et des vitesses d'avance élevées améliorant considérablement la productivité
6. Adapté aux matériaux P, M, K, S

NITICO 30 DP/DH ENDMILLS / WITH WELDON, 4 FLUTES

- VHM NiTiCo 30 DP/DH Fräser, 4 Zähne
- Frese NiTiCo 30, con passo differenziale, elica v ariabile, 4 taglienti
- Fraises NiTiCo 30 DP/DH à pas décalés et hélices différentes, 4 dents
- 整体硬质合金 NiTiCo 30 DP/DH 系列 4刃平底铣刀

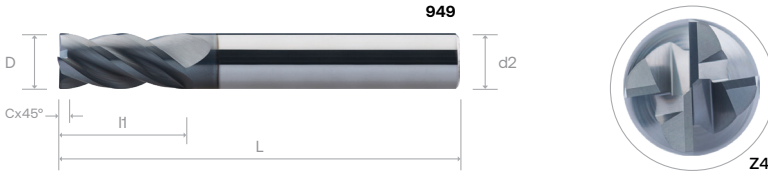
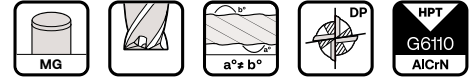

Order Number	Dimension (mm)							HA	Order Number	Dimension (mm)							HB
	D	I1	I2	L	d2 (h6)	C	G6110			D	I1	I2	L	d2 (h6)	C	G6110	
949 0400	4	11		57	6	0.1	•	C49 0400	4	11		57	6	0.1	◦		
949 0500	5	13		57	6	0.1	•	C49 0500	5	13		57	6	0.1	◦		
949 0600	6			57	6	0.1	•	C49 0600	6				57	6	0.1	◦	
949 0800	8	20		64	8	0.2	•	C49 0800	8	20		64	8	0.2	◦		
949 1000	10	22		72	10	0.2	•	C49 1000	10	22		72	10	0.2	◦		
949 1200	12	26		83	12	0.2	•	C49 1200	12	26		83	12	0.2	◦		
949 1400	14			83	14	0.3	•	C49 1400	14				83	14	0.3	◦	
949 1600	16	32		92	16	0.3	•	C49 1600	16	32		92	16	0.3	◦		
949 2000	20	38		104	20	0.4	•	C49 2000	20	38		104	20	0.4	◦		

ALU LINE
 EZ LINE - ENDMILL
 SE 30
NITICO 30
 OPTIMUM
 SE 45
 SE 45X
 NITICO 45
 SE 60
 SE 60X
 DN70 - SE 70
 SE GR
 TE 45
 PLUNGE -MILL
 THREAD MILL

CNC Repeatability
 Ø1 - Ø3 within 10µm
 Ø4 - Ø8 within 15µm
 ≥ Ø10 within 20µm

Material Group | Material-Gruppe | Groupe Matière | Gruppo Materiali | 材质主类

N01
N02
N03
K01
K02
P01
P02
P03
M01
M02
S01
S02
S03
H01
H02
O01
O02

Cutting Parameter

150 - 151

NITICO 30 DP/DH ENDMILLS, RECESS AND WELDON / WITH INTERNAL OIL HOLE, 4 FLUTES

- VHM NiTiCo 30 DP/DH Standard Fräser mit Innenkühlung, 4 Zähne
- Frese NiTiCo 30 con foro lubrificante interno, weldon e recesso, 4 taglienti
- Fraises NiTiCo 30 DP/DH av ec queue d'huile Weldon and dégagement - 4 dents
- 整体硬质合金 NiTiCo 30 DP/DH 系列 4刃平底铣刀(内冷孔、避空位和侧固柄)

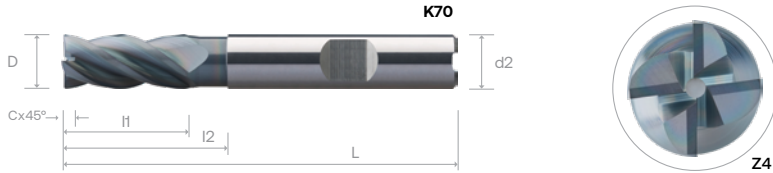
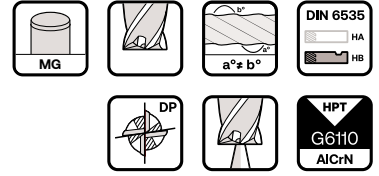

Order Number	Dimension (mm)							With Oil Hole	Order Number	Dimension (mm)							Without Oil Hole
	D	I1	I2	L	d2 (h6)	C	G610			D	I1	I2	L	d2 (h6)	C	G610	
K70 0400	4	11	15	57	6	0.1	°	K78 0400	4	11	15	57	6	0.1	•		
K70 0500 *	5	13	18	57	6	0.1	°	K78 0500	5	13	18	57	6	0.1	•		
K70 0600 *	6		19	57	6	0.1	°	K78 0600	6		19	57	6	0.1	•		
K70 0800 *	8	20	26	64	8	0.2	°	K78 0800	8	20	26	64	8	0.2	•		
K70 1000 *	10	22	30	72	10	0.2	°	K78 1000	10	22	30	72	10	0.2	•		
K70 1200 *	12	26	36	83	12	0.2	°	K78 1200	12	26	36	83	12	0.2	•		
K70 1400 *	14		36	83	14	0.3	°	K78 1400	14		36	83	14	0.3	°		
K70 1600 *	16	32	42	92	16	0.3	°	K78 1600	16	32	42	92	16	0.3	•		
K70 2000 *	20	38	52	104	20	0.4	°	K78 2000	20	38	52	104	20	0.4	•		

* - DIN 6535

CNC Repeatability
Ø1 - Ø3 within 10µm
Ø4 - Ø8 within 15µm
≥ Ø10 within 20µm

Material Group | Material-Gruppe | Groupe Matière | Gruppo Materiali | 材质主类

Cutting Parameter

N01	N02	N03	K01	K02	P01	P02	P03	M01	M02	S01	S02	S03	H01	H02	O01	O02	150 - 152
-----	-----	-----	-----	-----	-----	-----	-----	-----	-----	-----	-----	-----	-----	-----	-----	-----	-----------

NITICO 30 DP/DH TORUS ENDMILLS, 4 FLUTES

- VHM NiTiCo 30R DP/DH Torusfräser, 4 Zähne
- Frese toroidali NiTiCo 30, con passo differenziale, elica v ariabile, 4 taglienti
- Fraises NiTiCo 30 DP/DH toriques à pas décalés et hélices différentes, 4 dents
- 整体硬质合金 NiTiCo 30 DP/DH 系列 4刃平底铣刀

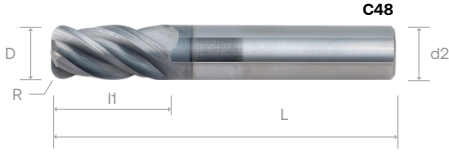
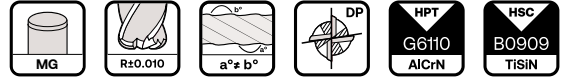

Order Number	Dimension (mm)						HA	G6f10	Order Number	Dimension (mm)						HA	B0909
	D	l1	l2	L	d2 (h6)	R				D	l1	l2	L	d2 (h6)	R		
C48 0400 057 0600 030	4	l1		57	6	0.3	◦	A1R 0400 057 0600 030	4	l1		57	6	0.3	◦		
C48 0400 057 0600 050				57	6	0.5	•	A1R 0400 057 0600 050				57	6	0.5	•		
C48 0500 057 0600 030	5			57	6	0.3	•	A1R 0500 057 0600 030	5			57	6	0.3	•		
C48 0500 057 0600 050				57	6	0.5	•	A1R 0500 057 0600 050				57	6	0.5	•		
C48 0600 057 0600 030	6	13		57	6	0.3	•	A1R 0600 057 0600 030	6	13		57	6	0.3	•		
C48 0600 057 0600 050				57	6	0.5	•	A1R 0600 057 0600 050				57	6	0.5	•		
C48 0600 057 0600 100	8	20		57	6	1	◦	A1R 0600 057 0600 100	8	20		57	6	1	◦		
C48 0800 064 0800 030				64	8	0.3	•	A1R 0800 064 0800 030				64	8	0.3	•		
C48 0800 064 0800 050	10	22		64	8	0.5	◦	A1R 0800 064 0800 050	10	22		64	8	0.5	◦		
C48 0800 064 0800 100				64	8	1	◦	A1R 0800 064 0800 100				64	8	1	◦		
C48 1000 072 1000 030	12	26		72	10	0.3	◦	A1R 1000 072 1000 030	12	26		72	10	0.3	•		
C48 1000 072 1000 050				72	10	0.5	•	A1R 1000 072 1000 050				72	10	0.5	◦		
C48 1000 072 1000 100	14	26		72	10	1	•	A1R 1000 072 1000 100	14	26		72	10	1	•		
C48 1200 083 1200 030				83	12	0.3	•	A1R 1200 083 1200 030				83	12	0.3	•		
C48 1200 083 1200 050	16	32		83	12	0.5	◦	A1R 1200 083 1200 050	16	32		83	12	0.5	◦		
C48 1200 083 1200 100				83	12	1	◦	A1R 1200 083 1200 100				83	12	1	◦		
C48 1200 083 1200 200	18	38		83	12	2	•	A1R 1200 083 1200 200	18	38		83	12	2	•		
C48 1200 083 1200 250				83	12	2.5	◦	A1R 1200 083 1200 250				83	12	2.5	◦		
C48 1200 083 1200 300	20	38		83	12	3	•	A1R 1200 083 1200 300	20	38		83	12	3	•		
C48 1400 083 1400 030				83	14	0.3	◦	A1R 1400 083 1400 030				83	14	0.3	◦		
C48 1400 083 1400 050	16	32		83	14	0.5	◦	A1R 1400 083 1400 050	16	32		83	14	0.5	◦		
C48 1400 083 1400 100				83	14	1	◦	A1R 1400 083 1400 100				83	14	1	◦		
C48 1400 083 1400 200	18	38		83	14	2	◦	A1R 1400 083 1400 200	18	38		83	14	2	◦		
C48 1400 083 1400 300				83	14	3	◦	A1R 1400 083 1400 300				83	14	3	◦		
C48 1600 092 1600 030	20	38		92	16	0.3	◦	A1R 1600 092 1600 030	20	38		92	16	0.3	◦		
C48 1600 092 1600 050				92	16	0.5	•	A1R 1600 092 1600 050				92	16	0.5	◦		
C48 1600 092 1600 100	16	32		92	16	1	•	A1R 1600 092 1600 100	16	32		92	16	1	◦		
C48 1600 092 1600 200				92	16	2	◦	A1R 1600 092 1600 200				92	16	2	•		
C48 1600 092 1600 250	18	38		92	16	2.5	◦	A1R 1600 092 1600 250	18	38		92	16	2.5	◦		
C48 1600 092 1600 300				92	16	3	◦	A1R 1600 092 1600 300				92	16	3	◦		
C48 1800 092 1800 030	20	38		92	16	4	•	A1R 1600 092 1600 400	20	38		92	16	4	•		
C48 1800 092 1800 050				92	18	0.3	◦	A1R 1800 092 1800 030				92	18	0.3	◦		
C48 1800 092 1800 100	16	32		92	18	0.5	◦	A1R 1800 092 1800 050	16	32		92	18	0.5	◦		
C48 1800 092 1800 200				92	18	1	◦	A1R 1800 092 1800 100				92	18	1	◦		
C48 1800 092 1800 300	18	38		92	18	2	◦	A1R 1800 092 1800 200	18	38		92	18	2	◦		
C48 2000 104 2000 030				92	18	3	◦	A1R 1800 092 1800 300				92	18	3	◦		
C48 2000 104 2000 050	20	38		104	20	0.3	◦	A1R 2000 104 2000 030	20	38		104	20	0.3	◦		
C48 2000 104 2000 100				104	20	0.5	•	A1R 2000 104 2000 050				104	20	0.5	◦		
C48 2000 104 2000 200	16	32		104	20	1	•	A1R 2000 104 2000 100	16	32		104	20	1	◦		
C48 2000 104 2000 250				104	20	2	◦	A1R 2000 104 2000 200				104	20	2	◦		
C48 2000 104 2000 300	18	38		104	20	2.5	◦	A1R 2000 104 2000 250	18	38		104	20	2.5	◦		
C48 2000 104 2000 400				104	20	3	•	A1R 2000 104 2000 300				104	20	3	•		
				104	20	4	•	A1R 2000 104 2000 400				104	20	4	◦		

ALU LINE
EZ LINE - ENDMILL
SE 30
NITICO 30
OPTIMUM
SE 45
SE 45X
NITICO 45
SE 60
SE 60X
DM70 - SE 70
SE GR
TE 45
PLUNGE -MILL
THREAD MILL

CNC Repeatability
Ø1 - Ø3 within 10µm
Ø4 - Ø8 within 15µm
≥ Ø10 within 20µm

Material Group | Material-Gruppe | Groupe Matiere | Gruppo Materiali | 材质主类

N01 N02 N03 K01 K02 P01 P02 P03 M01 M02 S01 S02 S03 H01 H02 O01 O02

Cutting Parameter
150 - 151

NITICO 30 DP/DH TORUS ENDMILLS WITH WELDON, 4 FLUTES

- VHM NiTiCo 30R DP/DH Torusfräser, 4 Zähne
- Frese toroidali NiTiCo 30, con passo differenziale, elica v variabile, 4 taglienti
- Fraises NiTiCo 30 DP/DH toriques à pas décalés et hélices différentes, 4 dents
- 整体硬质合金 NiTiCo 30 DP/DH 系列 4刃平底铣刀

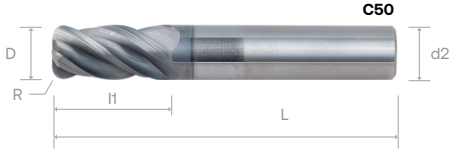
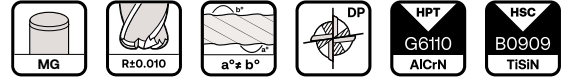

Order Number	Dimension (mm)						HB	G6110	Order Number	Dimension (mm)						HB	B0909
	D	I1	I2	L	d2 (H6)	R				D	I1	I2	L	d2 (H6)	R		
C50 0400 057 0600 030	4	11		57	6	0.3	°	A1T 0400 057 0600 030	4	11		57	6	0.3	°		
C50 0400 057 0600 050				57	6	0.5	°	A1T 0400 057 0600 050				57	6	0.5	°		
C50 0500 057 0600 030	5			57	6	0.3	°	A1T 0500 057 0600 030	5			57	6	0.3	°		
C50 0500 057 0600 050				57	6	0.5	°	A1T 0500 057 0600 050				57	6	0.5	°		
C50 0600 057 0600 030	6	13		57	6	0.3	°	A1T 0600 057 0600 030	6	13		57	6	0.3	°		
C50 0600 057 0600 050				57	6	0.5	°	A1T 0600 057 0600 050				57	6	0.5	°		
C50 0600 057 0600 100	8	20		57	6	1	°	A1T 0600 057 0600 100	8	20		57	6	1	°		
C50 0800 064 0800 030				64	8	0.3	°	A1T 0800 064 0800 030				64	8	0.3	°		
C50 0800 064 0800 050	10	22		64	8	0.5	°	A1T 0800 064 0800 050	10	22		64	8	0.5	°		
C50 0800 064 0800 100				64	8	1	°	A1T 0800 064 0800 100				64	8	1	°		
C50 1000 072 1000 030	12	26		72	10	0.3	°	A1T 1000 072 1000 030	12	26		72	10	0.3	°		
C50 1000 072 1000 050				72	10	0.5	°	A1T 1000 072 1000 050				72	10	0.5	°		
C50 1000 072 1000 100	14	26		72	10	1	°	A1T 1000 072 1000 100	14	26		72	10	1	°		
C50 1200 083 1200 030				83	12	0.3	°	A1T 1200 083 1200 030				83	12	0.3	°		
C50 1200 083 1200 050	16	32		83	12	0.5	°	A1T 1200 083 1200 050	16	32		83	12	0.5	°		
C50 1200 083 1200 100				83	12	1	°	A1T 1200 083 1200 100				83	12	1	°		
C50 1200 083 1200 200	18	38		83	12	2	°	A1T 1200 083 1200 200	18	38		83	12	2	°		
C50 1200 083 1200 250				83	12	2.5	°	A1T 1200 083 1200 250				83	12	2.5	°		
C50 1200 083 1200 300	20	38		83	12	3	°	A1T 1200 083 1200 300	20	38		83	12	3	°		
C50 1400 083 1400 030				83	14	0.3	°	A1T 1400 083 1400 030				83	14	0.3	°		
C50 1400 083 1400 050	16	32		83	14	0.5	°	A1T 1400 083 1400 050	16	32		83	14	0.5	°		
C50 1400 083 1400 100				83	14	1	°	A1T 1400 083 1400 100				83	14	1	°		
C50 1400 083 1400 200	18	38		83	14	2	°	A1T 1400 083 1400 200	18	38		83	14	2	°		
C50 1400 083 1400 300				83	14	3	°	A1T 1400 083 1400 300				83	14	3	°		
C50 1600 092 1600 030	20	38		92	16	0.3	°	A1T 1600 092 1600 030	20	38		92	16	0.3	°		
C50 1600 092 1600 050				92	16	0.5	°	A1T 1600 092 1600 050				92	16	0.5	°		
C50 1600 092 1600 100	16	32		92	16	1	°	A1T 1600 092 1600 100	16	32		92	16	1	°		
C50 1600 092 1600 200				92	16	2	°	A1T 1600 092 1600 200				92	16	2	°		
C50 1600 092 1600 250	18	38		92	16	2.5	-	A1T 1600 092 1600 250	18	38		92	16	2.5	-		
C50 1600 092 1600 300				92	16	3	°	A1T 1600 092 1600 300				92	16	3	°		
C50 1800 092 1800 030	20	38		92	16	4	°	A1T 1600 092 1600 400	20	38		92	16	4	°		
C50 1800 092 1800 050				92	18	0.3	°	A1T 1800 092 1800 030				92	18	0.3	°		
C50 1800 092 1800 100	16	32		92	18	0.5	°	A1T 1800 092 1800 050	16	32		92	18	0.5	°		
C50 1800 092 1800 200				92	18	1	°	A1T 1800 092 1800 100				92	18	1	°		
C50 1800 092 1800 250	18	38		92	18	2	°	A1T 1800 092 1800 200	18	38		92	18	2	°		
C50 1800 092 1800 300				92	18	3	°	A1T 1800 092 1800 300				92	18	3	°		
C50 2000 104 2000 030	20	38		104	20	0.3	°	A1T 2000 104 2000 030	20	38		104	20	0.3	°		
C50 2000 104 2000 050				104	20	0.5	°	A1T 2000 104 2000 050				104	20	0.5	°		
C50 2000 104 2000 100	16	32		104	20	1	°	A1T 2000 104 2000 100	16	32		104	20	1	°		
C50 2000 104 2000 200				104	20	2	°	A1T 2000 104 2000 200				104	20	2	°		
C50 2000 104 2000 250	18	38		104	20	2.5	°	A1T 2000 104 2000 250	18	38		104	20	2.5	°		
C50 2000 104 2000 300				104	20	3	°	A1T 2000 104 2000 300				104	20	3	°		
C50 2000 104 2000 400	104	20	4	°	A1T 2000 104 2000 400	104	20	4	°								

CNC Repeatability

Ø1 - Ø3 within 10µm
Ø4 - Ø8 within 15µm
≥ Ø10 within 20µm

Material Group | Material-Gruppe | Groupe Matière | Gruppo Materiali | 材质主类

Cutting Parameter

N01	N02	N03	K01	K02	P01	P02	P03	M01	M02	S01	S02	S03	H01	H02	O01	O02	150 - 151
-----	-----	-----	-----	-----	-----	-----	-----	-----	-----	-----	-----	-----	-----	-----	-----	-----	-----------

NITICO 30 DP/DH TORUS ENDMILLS / WITH WELDON, 4 FLUTES

- VHM NiTiCo 30R DP/DH Torusfräser, 4 Zähne
- Frese toroidali NiTiCo 30, con passo differenziale, elica v ariabile, 4 taglienti
- Fraises NiTiCo 30 DP/DH toriques à pas décalés et hélices différentes, 4 dents
- 整体硬质合金 NiTiCo 30R DP/DH 系列 4刃平底铣刀

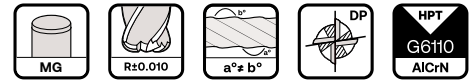

Order Number	Dimension (mm)						HA	Order Number	Dimension (mm)						HB
	D	l1	l2	L	d2 (h6)	R	G6110		D	l1	l2	L	d2 (h6)	R	G6110
J01 0400 057 0600 030	4	l1	20	57	6	0.3	◦	H98 0400 057 0600 030	4	l1	20	57	6	0.3	•
J01 0400 057 0600 050			20	57	6	0.5	•	H98 0400 057 0600 050			20	57	6	0.5	◦
J01 0500 057 0600 030	5	13	20	57	6	0.3	•	H98 0500 057 0600 030	5	13	20	57	6	0.3	•
J01 0500 057 0600 050			20	57	6	0.5	•	H98 0500 057 0600 050			20	57	6	0.5	•
J01 0600 057 0600 030	6	13	20	57	6	0.3	•	H98 0600 057 0600 030	6	13	20	57	6	0.3	◦
J01 0600 057 0600 050			20	57	6	0.5	•	H98 0600 057 0600 050			20	57	6	0.5	•
J01 0800 064 0800 030	8	20	30	64	8	0.3	•	H98 0800 064 0800 030	8	20	30	64	8	0.3	◦
J01 0800 064 0800 050			30	64	8	0.5	•	H98 0800 064 0800 050			30	64	8	0.5	•
J01 0800 064 0800 100	8	20	30	64	8	1	•	H98 0800 064 0800 100	8	20	30	64	8	1	◦
J01 1000 072 1000 030			30	64	8	0.3	◦	H98 1000 072 1000 030			30	64	8	0.3	◦
J01 1000 072 1000 050	10	22	32	72	10	0.5	•	H98 1000 072 1000 050	10	22	32	72	10	0.5	•
J01 1000 072 1000 100			32	72	10	1	•	H98 1000 072 1000 100			32	72	10	1	•
J01 1200 083 1200 030	12	26	37	83	12	0.3	•	H98 1200 083 1200 030	12	26	37	83	12	0.3	-
J01 1200 083 1200 050			37	83	12	0.5	◦	H98 1200 083 1200 050			37	83	12	0.5	◦
J01 1200 083 1200 100	12	26	37	83	12	1	◦	H98 1200 083 1200 100	12	26	37	83	12	1	◦
J01 1200 083 1200 200			37	83	12	2	◦	H98 1200 083 1200 200			37	83	12	2	•
J01 1200 083 1200 250	12	26	37	83	12	2.5	◦	H98 1200 083 1200 250	12	26	37	83	12	2.5	◦
J01 1200 083 1200 300			37	83	12	3	◦	H98 1200 083 1200 300			37	83	12	3	◦
J01 1400 083 1400 030	14	26	83	14	0.3	-	H98 1400 083 1400 030	14	26	83	14	0.3	-		
J01 1400 083 1400 050			83	14	0.5	-	H98 1400 083 1400 050			83	14	0.5	-		
J01 1400 083 1400 100	14	26	83	14	1	-	H98 1400 083 1400 100	14	26	83	14	1	-		
J01 1400 083 1400 200			83	14	2	-	H98 1400 083 1400 200			83	14	2	-		
J01 1400 083 1400 300	14	26	83	14	3	-	H98 1400 083 1400 300	14	26	83	14	3	-		
J01 1600 092 1600 030			92	16	0.3	-	H98 1600 092 1600 030			92	16	0.3	-		
J01 1600 092 1600 050	16	32	46	92	16	0.5	◦	H98 1600 092 1600 050	16	32	46	92	16	0.5	◦
J01 1600 092 1600 100			46	92	16	1	•	H98 1600 092 1600 100			46	92	16	1	•
J01 1600 092 1600 200	16	32	46	92	16	2	•	H98 1600 092 1600 200	16	32	46	92	16	2	•
J01 1600 092 1600 250			46	92	16	2.5	-	H98 1600 092 1600 250			46	92	16	2.5	-
J01 1600 092 1600 300	16	32	46	92	16	3	•	H98 1600 092 1600 300	16	32	46	92	16	3	◦
J01 1600 092 1600 400			46	92	16	4	◦	H98 1600 092 1600 400			46	92	16	4	◦
J01 1800 092 1800 030	18	38	92	18	0.3	-	H98 1800 092 1800 030	18	38	92	18	0.3	-		
J01 1800 092 1800 050			92	18	0.5	-	H98 1800 092 1800 050			92	18	0.5	-		
J01 1800 092 1800 100	18	38	92	18	1	-	H98 1800 092 1800 100	18	38	92	18	1	-		
J01 1800 092 1800 200			92	18	2	-	H98 1800 092 1800 200			92	18	2	-		
J01 1800 092 1800 300	18	38	92	18	3	-	H98 1800 092 1800 300	18	38	92	18	3	-		
J01 2000 104 2000 030			104	20	0.3	-	H98 2000 104 2000 030			104	20	0.3	-		
J01 2000 104 2000 050	20	38	58	104	20	0.5	◦	H98 2000 104 2000 050	20	38	58	104	20	0.5	◦
J01 2000 104 2000 100			58	104	20	1	◦	H98 2000 104 2000 100			58	104	20	1	•
J01 2000 104 2000 200	20	38	58	104	20	2	◦	H98 2000 104 2000 200	20	38	58	104	20	2	◦
J01 2000 104 2000 250			58	104	20	2.5	-	H98 2000 104 2000 250			58	104	20	2.5	-
J01 2000 104 2000 300	20	38	58	104	20	3	◦	H98 2000 104 2000 300	20	38	58	104	20	3	◦
J01 2000 104 2000 400			58	104	20	4	◦	H98 2000 104 2000 400			58	104	20	4	◦

ALU LINE
 EZ LINE - ENDMILL
 SE 30
NITICO 30
 OPTIMUM
 SE 45
 SE 45X
 NITICO 45
 SE 60
 SE 60X
 DN70 - SE70
 SE GR
 TE 45
 PLUNGE -MILL
 THREAD MILL

CNC Repeatability
 Ø1 - Ø3 within 10µm
 Ø4 - Ø8 within 15µm
 ≥ Ø10 within 20µm

Material Group | Material-Gruppe | Groupe Matiere | Gruppo Materiali | 材质主类

N01
N02
N03
K01
K02
P01
P02
P03
M01
M02
S01
S02
S03
H01
H02
O01
O02

Cutting Parameter
150 - 151

J97 / J98 / H38 / H39



NITICO 30 DP/DH TORUS LONG ENDMILLS / WITH RECESS, 4 FLUTES

- VHM NiTiCo 30 DP/DH Fräser, lang, 4 Zähne
- Frese lunghe NiTiCo 30, con passo differenziale, elica variabile, 4 taglienti
- Fraises NiTiCo 30 DP/DH longue, 4 dents
- 整体硬质合金 NiTiCo 30 DP/DH 系列 4刃长型平底铣刀

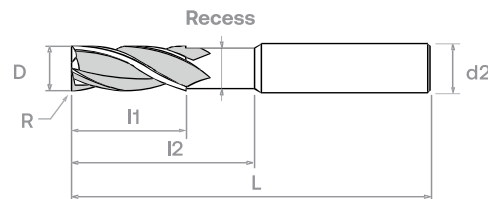
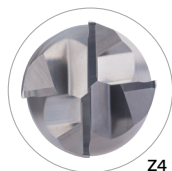
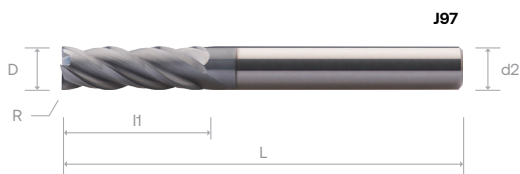
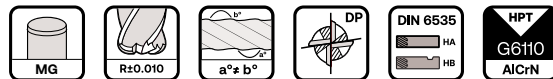

Order Number	Dimension (mm)							HA
	D	l1	l2	L	d2 (h6)	R	G6110	
J97 0400 075 06	4	19		75	6	0.1	°	
J97 0500 075 06	5			75	6	0.1	°	
J97 0600 075	6	25		75	6	0.1	°	
J97 0800 075	8	30		75	8	0.2	•	
J97 1000 100	10	40		100	10	0.2	•	
J97 1200 100	12	45		100	12	0.3	•	
J97 1600 125	16	65		125	16	0.3	°	
J97 2000 125	20			125	20	0.3	•	

Order Number	Dimension (mm)							HB
	D	l1	l2	L	d2 (h6)	R	G6110	
J98 0400 075 06	4	19		75	6	0.1	•	
J98 0500 075 06	5			75	6	0.1	•	
J98 0600 075	6	25		75	6	0.1	•	
J98 0800 075	8	30		75	8	0.2	•	
J98 1000 100	10	40		100	10	0.2	•	
J98 1200 100	12	45		100	12	0.3	°	
J98 1600 125	16	65		125	16	0.3	•	
J98 2000 125	20			125	20	0.3	•	

Order Number	Dimension (mm)							HA
	D	l1	l2	L	d2 (h6)	R	G6110	
H38 0400 075 06	4	19	32	75	6	0.1	•	
H38 0500 075 06	5		32	75	6	0.1	°	
H38 0600 075	6	25	32	75	6	0.1	°	
H38 0800 075 *	8	30	38	75	8	0.2	°	
H38 1000 100	10	40	50	100	10	0.2	°	
H38 1200 100 *	12	45	55	100	12	0.3	°	
H38 1600 125 *	16	65	75	125	16	0.3	°	
H38 2000 125 *	20		75	125	20	0.3	°	

Order Number	Dimension (mm)							HB
	D	l1	l2	L	d2 (h6)	R	G6110	
H39 0400 075 06	4	19	32	75	6	0.1	°	
H39 0500 075 06	5		32	75	6	0.1	°	
H39 0600 075	6	25	32	75	6	0.1	°	
H39 0800 075 *	8	30	38	75	8	0.2	°	
H39 1000 100	10	40	50	100	10	0.2	°	
H39 1200 100 *	12	45	55	100	12	0.3	°	
H39 1600 125 *	16	65	75	125	16	0.3	°	
H39 2000 125 *	20		75	125	20	0.3	°	

* - DIN 6535

CNC Repeatability
 Ø1 - Ø3 within 10µm
 Ø4 - Ø8 within 15µm
 ≥ Ø10 within 20µm

Material Group | Material-Gruppe | Groupe Matière | Gruppo Materiali | 材质主类

Cutting Parameter

N01	N02	N03	K01	K02	P01	P02	P03	M01	M02	S01	S02	S03	H01	H02	O01	O02	146
-----	-----	-----	-----	-----	-----	-----	-----	-----	-----	-----	-----	-----	-----	-----	-----	-----	-----

NITICO 30 DP ROUGHING ENDMILLS / WITH WELDON, 4 FLUTES

- VHM NiTiCo 30 DP Schrüppfräser, 4 Zähne
- Frese per sgrossare NiTiCo 30, con passo differenziale, 4 taglienti
- Fraises ébauches NiTiCo 30 DP à pas décalés - 4 dents
- 整体硬质合金 NiTiCo 30 DP 系列 4刃粗加工平底铣刀

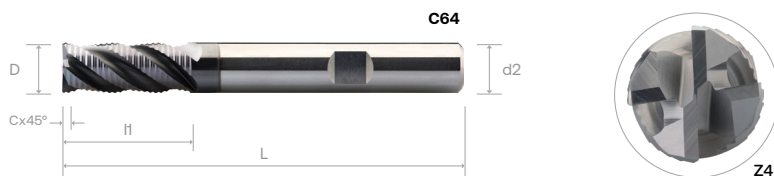
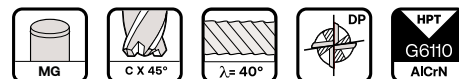

Order Number	Dimension (mm)							HA	Order Number	Dimension (mm)							HB
	D	I1	I2	L	d2 (h6)	C	G6110			D	I1	I2	L	d2 (h6)	R	G6110	
C47 0600 050	6	16		50	6	0.1	•	C64 0600 050	6	16		50	6	0.1	◦		
C47 0600 057				57	6	0.1	•	C64 0600 057				57	6	0.1	•		
C47 0800 064	8	20		64	8	0.2	•	C64 0800 064	8	20		64	8	0.2	•		
C47 1000 070	10	22		70	10	0.2	•	C64 1000 070	10	22		70	10	0.2	•		
C47 1000 072				72	10	0.2	•	C64 1000 072				72	10	0.2	•		
C47 1000 075				75	10	0.2	•	C64 1000 075				75	10	0.2	◦		
C47 1200 075	12	26		75	12	0.2	•	C64 1200 075	12	26		75	12	0.2	•		
C47 1200 083				83	12	0.2	•	C64 1200 083				83	12	0.2	•		
C47 1400 083	14	32		83	14	0.3	•	C64 1400 083	14	32		83	14	0.3	•		
C47 1400 090				90	14	0.3	•	C64 1400 090				90	14	0.3	◦		
C47 1600 090	16	38		90	16	0.3	•	C64 1600 090	16	38		90	16	0.3	•		
C47 1600 092				92	16	0.3	•	C64 1600 092				92	16	0.3	◦		
C47 1800 092	18	38		92	18	0.3	•	C64 1800 092	18	38		92	18	0.3	◦		
C47 1800 100				100	18	0.3	•	C64 1800 100				100	18	0.3	◦		
C47 2000 100	20	38		100	20	0.4	•	C64 2000 100	20	38		100	20	0.4	◦		
C47 2000 104				104	20	0.4	•	C64 2000 104				104	20	0.4	•		

ALU LINE
 EZ LINE - ENDMILL
 SE 30
 NITICO 30
 OPTIMUM
 SE 45
 SE 45X
 NITICO 45
 SE 60
 SE 60X
 DN70 - SE 70
 SE GR
 TE 45
 PLUNGE -MILL
 THREAD MILL

Material Group | Material-Gruppe | Groupe Matière | Gruppo Materiali | 材质主类

Cutting Parameter

N01	N02	N03	K01	K02	P01	P02	P03	M01	M02	S01	S02	S03	H01	H02	O01	O02
-----	-----	-----	-----	-----	-----	-----	-----	-----	-----	-----	-----	-----	-----	-----	-----	-----

148

NITICO 30 MINIATURE ENDMILLS WITH LONG NECK, 2 FLUTES

- VHM NiTiCo 30 Kleinstfräser mit langem Hals, 2 Zähne
- Micro-frese NiTiCo 30, con collo lungo, 2 taglienti
- Micro-fraises NiTiCo 30 av ec cou long, 2 dents
- 整体硬质合金 NiTiCo 30 系列 微小径2刃长颈平底铣刀

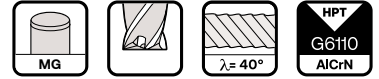

Order Number	Dimension (mm)						G6110	Order Number	Dimension (mm)						G6110	
	D	l1	l2	L	d1	d2 (h6)			D	l1	l2	L	d1	d2 (h6)		
G87 0020 050 0400	0.2	0.3	-	50	0.17	4	°	G87 0120 050 0400	1.2	1.8	-	50	1.1	4	°	
G87 0020 050 0400 005			0.5	50	0.17	4	°				G87 0120 050 0400 060	6.0	50	1.1	4	•
G87 0020 050 0400 010			1	50	0.17	4	•				G87 0120 050 0400 080	8.0	50	1.1	4	•
G87 0020 050 0400 015	0.3	0.4	1.5	50	0.17	4	°	G87 0120 050 0400 100	1.4	2.1	10	50	1.1	4	•	
G87 0030 050 0400			-	50	0.27	4	°	G87 0120 050 0400 120			12	50	1.1	4	•	
G87 0030 050 0400 010			1	50	0.27	4	•	G87 0140 050 0400			-	50	1.3	4	°	
G87 0030 050 0400 020	0.4	0.6	2	50	0.27	4	•	G87 0140 050 0400 060	1.5	2.3	6.0	50	1.3	4	°	
G87 0030 050 0400 030			3	50	0.27	4	•	G87 0140 050 0400 080			8.0	50	1.3	4	°	
G87 0040 050 0400			-	50	0.37	4	°	G87 0140 050 0400 100			10	50	1.3	4	°	
G87 0040 050 0400 020	0.5	0.7	2	50	0.37	4	•	G87 0140 050 0400 120	1.6	2.4	12	50	1.3	4	°	
G87 0040 050 0400 030			3	50	0.37	4	°	G87 0140 050 0400 140			14	50	1.3	4	°	
G87 0040 050 0400 040			4	50	0.37	4	•	G87 0140 050 0400 160 *			16	50	1.3	4	°	
G87 0040 050 0400 050	0.6	0.9	5	50	0.37	4	°	G87 0150 050 0400	1.8	2.7	-	50	1.4	4	°	
G87 0050 050 0400			-	50	0.45	4	°	G87 0150 050 0400 060			6.0	50	1.4	4	•	
G87 0050 050 0400 020			2	50	0.45	4	•	G87 0150 050 0400 080			8.0	50	1.4	4	•	
G87 0050 050 0400 040	0.7	1.0	4	50	0.45	4	•	G87 0150 050 0400 100	1.8	2.7	10	50	1.4	4	•	
G87 0050 050 0400 060			6	50	0.45	4	•	G87 0150 050 0400 120			12	50	1.4	4	•	
G87 0050 050 0400 080			8	50	0.45	4	•	G87 0150 050 0400 140			14	50	1.4	4	°	
G87 0060 050 0400	0.8	1.2	-	50	0.55	4	°	G87 0150 050 0400 160 *	2.0	3.0	16	50	1.4	4	•	
G87 0060 050 0400 020			2	50	0.55	4	•	G87 0150 060 0400			-	60	1.4	4	°	
G87 0060 050 0400 040			4	50	0.55	4	•	G87 0150 060 0400 180			18	60	1.4	4	°	
G87 0060 050 0400 060	0.9	1.4	6	50	0.55	4	•	G87 0150 060 0400 200	1.8	2.7	20	60	1.4	4	•	
G87 0060 050 0400 080			8	50	0.55	4	°	G87 0160 050 0400			-	50	1.5	4	°	
G87 0060 050 0400 100			10	50	0.55	4	°	G87 0160 050 0400 060			6.0	50	1.5	4	°	
G87 0070 050 0400	1.0	1.5	-	50	0.65	4	°	G87 0160 050 0400 080	2.0	3.0	8.0	50	1.5	4	°	
G87 0070 050 0400 020			2	50	0.65	4	°	G87 0160 050 0400 100			10	50	1.5	4	°	
G87 0070 050 0400 040			4	50	0.65	4	°	G87 0160 050 0400 120			12	50	1.5	4	°	
G87 0070 050 0400 060	0.8	1.2	6	50	0.65	4	°	G87 0160 050 0400 140	1.8	2.7	14	50	1.5	4	°	
G87 0070 050 0400 080			8	50	0.65	4	°	G87 0160 050 0400 160 *			16	50	1.5	4	°	
G87 0070 050 0400 100			10	50	0.65	4	°	G87 0160 060 0400			-	60	1.5	4	°	
G87 0080 050 0400	0.9	1.4	-	50	0.75	4	°	G87 0160 060 0400 180	2.0	3.0	18	60	1.5	4	°	
G87 0080 050 0400 040			4	50	0.75	4	•	G87 0160 060 0400 200			20	60	1.5	4	°	
G87 0080 050 0400 060			6	50	0.75	4	•	G87 0180 050 0400			-	50	1.7	4	°	
G87 0080 050 0400 080	1.0	1.5	8	50	0.75	4	°	G87 0180 050 0400 060	2.0	3.0	6	50	1.7	4	°	
G87 0080 050 0400 100			10	50	0.75	4	°	G87 0180 050 0400 080			8	50	1.7	4	°	
G87 0080 050 0400 120			12	50	0.75	4	°	G87 0180 050 0400 100			10	50	1.7	4	°	
G87 0090 050 0400	0.8	1.2	-	50	0.85	4	°	G87 0180 050 0400 120	1.8	2.7	12	50	1.7	4	°	
G87 0090 050 0400 060			6	50	0.85	4	°	G87 0180 050 0400 140			14	50	1.7	4	°	
G87 0090 050 0400 080			8	50	0.85	4	°	G87 0180 050 0400 160 *			16	50	1.7	4	°	
G87 0090 050 0400 100	0.9	1.4	10	50	0.85	4	°	G87 0180 060 0400	2.0	3.0	-	60	1.7	4	°	
G87 0090 050 0400 150 *			15	50	0.85	4	°	G87 0180 060 0400 180			18	60	1.7	4	°	
G87 0100 050 0400			-	50	0.9	4	°	G87 0180 060 0400 200			20	60	1.7	4	°	
G87 0100 050 0400 060	1.0	1.5	6.0	50	0.9	4	•	G87 0200 050 0400	2.0	3.0	-	50	1.9	4	°	
G87 0100 050 0400 080			8.0	50	0.9	4	•	G87 0200 050 0400 060			6	50	1.9	4	•	
G87 0100 050 0400 100			10	50	0.9	4	•	G87 0200 050 0400 080			8	50	1.9	4	•	
G87 0100 050 0400 120	0.8	1.2	12	50	0.9	4	°	G87 0200 050 0400 100	1.8	2.7	10	50	1.9	4	•	
G87 0100 050 0400 140			14	50	0.9	4	°	G87 0200 050 0400 120			12	50	1.9	4	•	
G87 0100 050 0400 160 *			16	50	0.9	4	°	G87 0200 050 0400 140			14	50	1.9	4	•	

* - DIN 6535

cont'd ▶

Material Group | Material-Gruppe | Groupe Matière | Gruppo Materiali | 材质主类

Cutting Parameter

N01	N02	N03	K01	K02	P01	P02	P03	M01	M02	S01	S02	S03	H01	H02	O01	O02	153 - 156
-----	-----	-----	-----	-----	-----	-----	-----	-----	-----	-----	-----	-----	-----	-----	-----	-----	-----------

NITICO 30 MINIATURE ENDMILLS WITH LONG NECK, 2 FLUTES

- VHM NiTiCo 30 Kleinstfräser mit langem Hals, 2 Zähne
- Micro-frese NiTiCo 30, con collo lungo, 2 taglienti
- Micro-fraises NiTiCo 30 av ec cou long, 2 dents
- 整体硬质合金 NiTiCo 30 系列 微小径2刃长颈平底铣刀

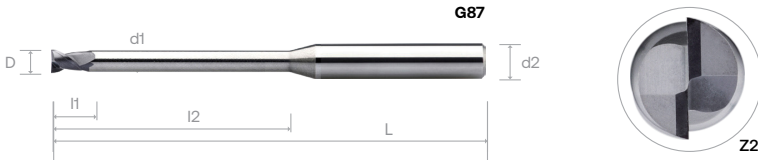

Order Number	Dimension (mm)						G6110	Order Number	Dimension (mm)						G6110		
	D	I1	I2	L	d1	d2 (r6)			D	I1	I2	L	d1	d2 (r6)			
G87 0200 050 0400 160	2	3	16	50	1.9	4	•										
G87 0200 060 0400			-	60	1.9	4	◦										
G87 0200 060 0400 180			18	60	1.9	4	◦										
G87 0200 060 0400 200			20	60	1.9	4	•										
G87 0200 075 0400			-	75	1.9	4	◦										
G87 0200 075 0400 250			25	75	1.9	4	•										
G87 0200 075 0400 300	30	75	1.9	4	•												
G87 0250 050 0400	2.5	3.7	-	50	2.4	4	◦										
G87 0250 050 0400 080			8	50	2.4	4	•										
G87 0250 050 0400 100			10	50	2.4	4	•										
G87 0250 050 0400 120			12	50	2.4	4	◦										
G87 0250 050 0400 140			14	50	2.4	4	◦										
G87 0250 050 0400 160			16	50	2.4	4	◦										
G87 0250 060 0400			-	60	2.4	4	◦										
G87 0250 060 0400 180			18	60	2.4	4	•										
G87 0250 060 0400 200			20	60	2.4	4	•										
G87 0250 060 0400 250			25	60	2.4	4	◦										
G87 0250 075 0400			-	75	2.4	4	◦										
G87 0250 075 0400 300			30	75	2.4	4	◦										
G87 0300 050 0600	3	4.5	-	50	2.8	6	◦										
G87 0300 050 0600 080 *			8	50	2.8	6	•										
G87 0300 050 0600 100			10	50	2.8	6	•										
G87 0300 050 0600 120			12	50	2.8	6	•										
G87 0300 050 0600 140			14	50	2.8	6	◦										
G87 0300 060 0600			-	60	2.8	6	◦										
G87 0300 060 0600 160			16	60	2.8	6	•										
G87 0300 060 0600 180 *			18	60	2.8	6	◦										
G87 0300 060 0600 200			20	60	2.8	6	•										
G87 0300 075 0600			-	75	2.8	6	◦										
G87 0300 075 0600 250			25	75	2.8	6	•										
G87 0400 060 0600			4	4.5	-	60	3.7	6	◦								
G87 0400 060 0600 100	10	60			3.7	6	◦										
G87 0400 060 0600 150	15	60			3.7	6	◦										
G87 0400 060 0600 200	20	60			3.7	6	•										
G87 0400 075 0600	-	75			3.7	6	◦										
G87 0400 075 0600 250	25	75			3.7	6	◦										
G87 0400 075 0600 300	30	75			3.7	6	•										
G87 0400 075 0600 400	40	75			3.7	6	◦										

* - DIN 6535

ALU LINE
 EZ LINE - ENDMILL
 SE 30
NITICO 30
 OPTIMUM
 SE 45
 SE 45X
 SE 60
 SE 60X
 DM70 - SE 70
 SE GR
 TE 45
 PLUNGE -MILL
 THREAD MILL

Material Group | Material-Gruppe | Groupe Matière | Gruppo Materiali | 材质主类

Cutting Parameter

N01	N02	N03	K01	K02	P01	P02	P03	M01	M02	S01	S02	S03	H01	H02	O01	O02
-----	-----	-----	-----	-----	-----	-----	-----	-----	-----	-----	-----	-----	-----	-----	-----	-----

153 - 156

NITICO 30 MINIATURE TORUS ENDMILLS WITH LONG NECK, 2 FLUTES

- VHM NiTiCo 30 Toruskleinsträßer mit langem Hals, 2 Zähne
- Micro-frese toroidali NiTiCo 30, con collo lungo, 2 taglienti
- Micro-fraises NiTiCo 30 toriques av ec cou long, 2 dents
- 整体硬质合金 NiTiCo 30 系列 微小径2刃长颈圆鼻铣刀

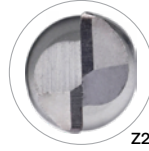

Order Number	Dimension (mm)							G6110	Order Number	Dimension (mm)							G6110
	D	I1	I2	L	d1	d2(h6)	R			D	I1	I2	L	d1	d2(h6)	R	
H56 0020 050 0400	0.2	0.3	-	50	0.17	4	0.05	°	H56 0120 050 0400	1.2	1.8	-	50	1.1	4	0.10	°
H56 0020 050 0400 005			0.5	50	0.17	4	0.05	°	H56 0120 050 0400 060			6	50	1.1	4	0.10	•
H56 0020 050 0400 010			1	50	0.17	4	0.05	°	H56 0120 050 0400 080			8	50	1.1	4	0.10	°
H56 0020 050 0400 015	0.3	0.4	1.5	50	0.17	4	0.05	°	H56 0120 050 0400 100	10	50	1.1	4	0.10	°		
H56 0030 050 0400			-	50	0.27	4	0.05	°	H56 0120 050 0400 120	12	50	1.1	4	0.10	•		
H56 0030 050 0400 010			1	50	0.27	4	0.05	°	H56 0140 050 0400	-	50	1.3	4	0.10	°		
H56 0030 050 0400 020	0.4	0.6	2	50	0.27	4	0.05	°	H56 0140 050 0400 060	6	50	1.3	4	0.10	°		
H56 0030 050 0400 030			3	50	0.27	4	0.05	°	H56 0140 050 0400 080	8	50	1.3	4	0.10	°		
H56 0040 050 0400			-	50	0.37	4	0.05	°	H56 0140 050 0400 100	10	50	1.3	4	0.10	°		
H56 0040 050 0400 020	0.5	0.7	2	50	0.37	4	0.05	°	H56 0140 050 0400 120	12	50	1.3	4	0.10	°		
H56 0040 050 0400 030			3	50	0.37	4	0.05	°	H56 0140 050 0400 140	14	50	1.3	4	0.10	°		
H56 0040 050 0400 040			4	50	0.37	4	0.05	°	H56 0140 050 0400 160 *	16	50	1.3	4	0.10	°		
H56 0040 050 0400 050	0.6	0.9	5	50	0.37	4	0.05	°	H56 0150 050 0400	-	50	1.4	4	0.20	°		
H56 0050 050 0400			-	50	0.45	4	0.05	°	H56 0150 050 0400 060	6	50	1.4	4	0.20	•		
H56 0050 050 0400 020			2	50	0.45	4	0.05	°	H56 0150 050 0400 080	8	50	1.4	4	0.20	°		
H56 0050 050 0400 040	0.7	1.0	4	50	0.45	4	0.05	•	H56 0150 050 0400 100	10	50	1.4	4	0.20	•		
H56 0050 050 0400 060			6	50	0.45	4	0.05	•	H56 0150 050 0400 120	12	50	1.4	4	0.20	•		
H56 0050 050 0400 080			8	50	0.45	4	0.05	°	H56 0150 050 0400 140	14	50	1.4	4	0.20	°		
H56 0060 050 0400	0.8	1.2	-	50	0.55	4	0.05	°	H56 0150 050 0400 160 *	16	50	1.4	4	0.20	•		
H56 0060 050 0400 020			2	50	0.55	4	0.05	•	H56 0150 060 0400	-	60	1.4	4	0.20	°		
H56 0060 050 0400 040			4	50	0.55	4	0.05	°	H56 0150 060 0400 180	18	60	1.4	4	0.20	°		
H56 0060 050 0400 060	0.9	1.4	6	50	0.55	4	0.05	•	H56 0150 060 0400 200	20	60	1.4	4	0.20	•		
H56 0060 050 0400 080			8	50	0.55	4	0.05	°	H56 0160 050 0400	-	50	1.5	4	0.20	°		
H56 0060 050 0400 100			10	50	0.55	4	0.05	°	H56 0160 050 0400 060	6	50	1.5	4	0.20	°		
H56 0070 050 0400	1.0	1.5	-	50	0.65	4	0.10	°	H56 0160 050 0400 080	8	50	1.5	4	0.20	°		
H56 0070 050 0400 020			2	50	0.65	4	0.10	°	H56 0160 050 0400 100	10	50	1.5	4	0.20	°		
H56 0070 050 0400 040			4	50	0.65	4	0.10	°	H56 0160 050 0400 120	12	50	1.5	4	0.20	°		
H56 0070 050 0400 060	1.2	1.8	6	50	0.65	4	0.10	°	H56 0160 050 0400 140	14	50	1.5	4	0.20	°		
H56 0070 050 0400 080			8	50	0.65	4	0.10	°	H56 0160 050 0400 160 *	16	50	1.5	4	0.20	°		
H56 0070 050 0400 100			10	50	0.65	4	0.10	°	H56 0160 060 0400	-	60	1.5	4	0.20	°		
H56 0080 050 0400	1.4	2.1	-	50	0.75	4	0.10	°	H56 0160 060 0400 180	18	60	1.5	4	0.20	°		
H56 0080 050 0400 040			4	50	0.75	4	0.10	•	H56 0160 060 0400 200	20	60	1.5	4	0.20	°		
H56 0080 050 0400 060			6	50	0.75	4	0.10	•	H56 0180 050 0400	-	50	1.7	4	0.20	°		
H56 0080 050 0400 080	1.8	2.7	8	50	0.75	4	0.10	•	H56 0180 050 0400 060	6	50	1.7	4	0.20	°		
H56 0080 050 0400 100			10	50	0.75	4	0.10	°	H56 0180 050 0400 080	8	50	1.7	4	0.20	°		
H56 0080 050 0400 120			12	50	0.75	4	0.10	°	H56 0180 050 0400 100	10	50	1.7	4	0.20	°		
H56 0090 050 0400	2.0	3.0	-	50	0.85	4	0.10	°	H56 0180 050 0400 120	12	50	1.7	4	0.20	°		
H56 0090 050 0400 060			6	50	0.85	4	0.10	°	H56 0180 050 0400 140	14	50	1.7	4	0.20	°		
H56 0090 050 0400 080			8	50	0.85	4	0.10	°	H56 0180 050 0400 160 *	16	50	1.7	4	0.20	°		
H56 0090 050 0400 100	2.4	3.6	10	50	0.85	4	0.10	°	H56 0180 060 0400	-	60	1.7	4	0.20	°		
H56 0100 050 0400 *			15	50	0.85	4	0.10	°	H56 0180 060 0400 180	18	60	1.7	4	0.20	°		
H56 0100 050 0400			-	50	0.9	4	0.10	°	H56 0180 060 0400 200	20	60	1.7	4	0.20	°		
H56 0100 050 0400 060	2.8	4.2	6	50	0.9	4	0.10	•	H56 0200 050 0400	-	50	1.9	4	0.20	°		
H56 0100 050 0400 080			8	50	0.9	4	0.10	•	H56 0200 050 0400 060	6	50	1.9	4	0.20	•		
H56 0100 050 0400 100			10	50	0.9	4	0.10	•	H56 0200 050 0400 080	8	50	1.9	4	0.20	°		
H56 0100 050 0400 120	3.2	4.8	12	50	0.9	4	0.10	•	H56 0200 050 0400 100	10	50	1.9	4	0.20	•		
H56 0100 050 0400 140			14	50	0.9	4	0.10	°	H56 0200 050 0400 120	12	50	1.9	4	0.20	•		
H56 0100 050 0400 160 *			16	50	0.9	4	0.10	•	H56 0200 050 0400 140	14	50	1.9	4	0.20	°		

* - DIN 6535

cont'd ▶

Material Group | Material-Gruppe | Groupe Matière | Gruppo Materiali | 材质主类

Cutting Parameter

N01	N02	N03	K01	K02	P01	P02	P03	M01	M02	S01	S02	S03	H01	H02	O01	O02	153 - 156
-----	-----	-----	-----	-----	-----	-----	-----	-----	-----	-----	-----	-----	-----	-----	-----	-----	-----------

NITICO 30 MINIATURE TORUS ENDMILLS WITH LONG NECK, 2 FLUTES

- VHM NiTiCo 30 Toruskleinstfräser mit langem Hals, 2 Zähne
- Micro-frese toroidali NiTiCo 30, con collo lungo, 2 taglianti
- Micro-fraises NiTiCo30 toriques av ec cou long, 2 dents
- 整体硬质合金 NiTiCo 30 系列 微小径2刃长颈圆鼻铣刀

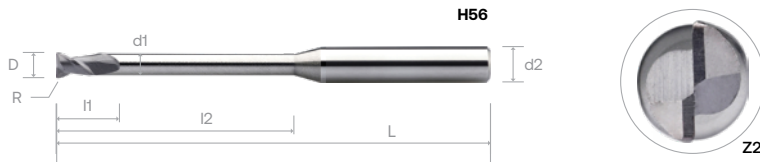

Order Number	Dimension (mm)							G6110	Order Number	Dimension (mm)							G6110	
	D	I1	I2	L	d1	d2(h6)	R			D	I1	I2	L	d1	d2(h6)	R		
H56 0200 050 0400 160	2	3	16	50	1.9	4	0.20	•										
H56 0200 060 0400			-	60	1.9	4	0.20	◦										
H56 0200 060 0400 180			18	60	1.9	4	0.20	◦										
H56 0200 060 0400 200			20	60	1.9	4	0.20	•										
H56 0200 075 0400			-	75	1.9	4	0.20	◦										
H56 0200 075 0400 250			25	75	1.9	4	0.20	•										
H56 0200 075 0400 300			30	75	1.9	4	0.20	◦										
H56 0250 050 0400			-	50	2.4	4	0.30	◦										
H56 0250 050 0400 080			8	50	2.4	4	0.30	•										
H56 0250 050 0400 100			10	50	2.4	4	0.30	◦										
H56 0250 050 0400 120	12	50	2.4	4	0.30	•												
H56 0250 050 0400 140	14	50	2.4	4	0.30	◦												
H56 0250 050 0400 160	16	50	2.4	4	0.30	•												
H56 0250 060 0400	-	60	2.4	4	0.30	◦												
H56 0250 060 0400 180	18	60	2.4	4	0.30	◦												
H56 0250 060 0400 200	20	60	2.4	4	0.30	•												
H56 0250 060 0400 250	25	60	2.4	4	0.30	•												
H56 0250 075 0400	-	75	2.4	4	0.30	◦												
H56 0250 075 0400 300	30	75	2.4	4	0.30	◦												
H56 0300 050 0600	-	50	2.8	6	0.30	◦												
H56 0300 050 0600 080 *	8	50	2.8	6	0.30	•												
H56 0300 050 0600 100	10	50	2.8	6	0.30	•												
H56 0300 050 0600 120	12	50	2.8	6	0.30	•												
H56 0300 050 0600 140	14	50	2.8	6	0.30	◦												
H56 0300 060 0600	-	60	2.8	6	0.30	◦												
H56 0300 060 0600 160	16	60	2.8	6	0.30	◦												
H56 0300 060 0600 180 *	18	60	2.8	6	0.30	◦												
H56 0300 060 0600 200	20	60	2.8	6	0.30	•												
H56 0300 075 0600	-	75	2.8	6	0.30	◦												
H56 0300 075 0600 250	25	75	2.8	6	0.30	◦												
H56 0400 060 0600	-	60	3.7	6	0.40	◦												
H56 0400 060 0600 100	10	60	3.7	6	0.40	◦												
H56 0400 060 0600 150	15	60	3.7	6	0.40	◦												
H56 0400 060 0600 200	20	60	3.7	6	0.40	•												
H56 0400 075 0600	-	75	3.7	6	0.40	◦												
H56 0400 075 0600 250	25	75	3.7	6	0.40	◦												
H56 0400 075 0600 300	30	75	3.7	6	0.40	◦												
H56 0400 075 0600 400	40	75	3.7	6	0.40	◦												

* - DIN 6535

ALU LINE
 EZ LINE - ENDMILL
 SE 30
NITICO 30
 OPTIMUM
 SE 45
 SE 45X
 SE 45X
 NITICO 45
 SE 60
 SE 60X
 DN70 - SE 70
 SE GR
 TE 45
 PLUNGE -MILL
 THREAD MILL

Material Group | Material-Gruppe | Groupe Matière | Gruppo Materiali | 材质主类

Cutting Parameter

N01	N02	N03	K01	K02	P01	P02	P03	M01	M02	S01	S02	S03	H01	H02	O01	O02
-----	-----	-----	-----	-----	-----	-----	-----	-----	-----	-----	-----	-----	-----	-----	-----	-----

153 - 156

NITICO 30 MINIATURE BALLNOSE CUTTERS WITH LONG NECK, 2 FLUTES

- VHM NiTiCo 30 Kleinstradiusfräser mit langem Hals, 2 Zähne
- Micro-frese sferiche NiTiCo 30, con collo lungo, 2 taglianti
- Micro-fraises NiTiCo 30 à bout hémisphérique av ec cou long, 2 dents
- 整体硬质合金 NiTiCo 30 系列 微小径2刃长颈球头铣刀

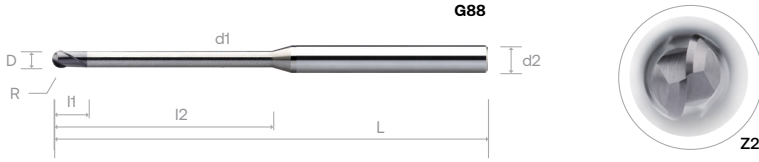

Order Number	Dimension (mm)							G6110	Order Number	Dimension (mm)							G6110	
	D	R	I1	I2	L	d1	d2(h6)			D	R	I1	I2	L	d1	d2(h6)		
G88 0020 050 0400	0.2	0.10	0.2	-	50	0.17	4	o	G88 0150 050 0400	1.5	0.75	1.2	-	50	1.4	4	o	
G88 0020 050 0400 005				0.5	50	0.17	4	o					G88 0150 050 0400 080	8.0	50	1.4	4	o
G88 0020 050 0400 010				1.0	50	0.17	4	o					G88 0150 050 0400 120	12.0	50	1.4	4	o
G88 0020 050 0400 015				1.5	50	0.17	4	o					G88 0150 050 0400 160 *	16.0	50	1.4	4	o
G88 0030 050 0400				-	50	0.27	4	o					G88 0150 060 0400	-	60	-	4	o
G88 0030 050 0400 010	0.3	0.15	0.3	1.0	50	0.27	4	o	G88 0160 050 0400 180	18.0	60	1.4	4	o				
G88 0030 050 0400 020				2.0	50	0.27	4	o	G88 0160 050 0400	-	50	1.5	4	o				
G88 0030 050 0400 030				3.0	50	0.27	4	o	G88 0160 050 0400 080	8.0	50	1.5	4	o				
G88 0040 050 0400				-	50	0.37	4	o	G88 0160 050 0400 120	12.0	50	1.5	4	o				
G88 0040 050 0400 010				1.0	50	0.37	4	o	G88 0160 050 0400 160 *	16.0	50	1.5	4	o				
G88 0040 050 0400 020	0.4	0.20	0.4	2.0	50	0.37	4	o	G88 0160 060 0400	-	60	-	4	o				
G88 0040 050 0400 030				3.0	50	0.37	4	o	G88 0160 060 0400 200	20.0	60	1.5	4	o				
G88 0040 050 0400 040				4.0	50	0.37	4	o	G88 0180 050 0400	-	50	-	4	o				
G88 0040 050 0400 050				5.0	50	0.37	4	o	G88 0180 050 0400 080	8.0	50	1.7	4	o				
G88 0050 050 0400				-	50	0.45	4	o	G88 0180 050 0400 120	12.0	50	1.7	4	o				
G88 0050 050 0400 020	0.5	0.25	0.4	2.0	50	0.45	4	o	G88 0180 050 0400 160 *	16.0	50	1.7	4	o				
G88 0050 050 0400 030				3.0	50	0.45	4	o	G88 0180 060 0400	-	60	-	4	o				
G88 0050 050 0400 040				4.0	50	0.45	4	o	G88 0180 060 0400 200	20	60	1.7	4	o				
G88 0050 050 0400 050				5.0	50	0.45	4	o	G88 0200 050 0400	-	50	1.9	4	o				
G88 0050 050 0400 060				6.0	50	0.45	4	o	G88 0200 050 0400 040	4	50	1.9	4	o				
G88 0050 050 0400 080	8.0	50	0.45	4	o	G88 0200 050 0400 060	6	50	1.9	4	o							
G88 0060 050 0400	-	50	0.55	4	o	G88 0200 050 0400 080	8	50	1.9	4	o							
G88 0060 050 0400 020	0.6	0.30	0.5	2.0	50	0.55	4	o	G88 0200 050 0400 100	10	50	1.9	4	o				
G88 0060 050 0400 030				3.0	50	0.55	4	o	G88 0200 050 0400 120	12	50	1.9	4	o				
G88 0060 050 0400 040				4.0	50	0.55	4	o	G88 0200 050 0400 140	14	50	1.9	4	o				
G88 0060 050 0400 050				5.0	50	0.55	4	o	G88 0200 050 0400 160	16	50	1.9	4	o				
G88 0060 050 0400 060				6.0	50	0.55	4	o	G88 0200 060 0400	-	60	1.9	4	o				
G88 0060 050 0400 080	8.0	50	0.55	4	o	G88 0200 060 0400 180	18	60	1.9	4	o							
G88 0080 050 0400	-	50	0.75	4	o	G88 0200 060 0400 200	20	60	1.9	4	o							
G88 0080 050 0400 020	0.8	0.40	0.6	2.0	50	0.75	4	o	G88 0200 060 0400 220	22	60	1.9	4	o				
G88 0080 050 0400 040				4.0	50	0.75	4	o	G88 0200 075 0400	-	75	1.9	4	o				
G88 0080 050 0400 050				5.0	50	0.75	4	o	G88 0200 075 0400 250	25	75	1.9	4	o				
G88 0080 050 0400 060				6.0	50	0.75	4	o	G88 0200 075 0400 300	30	75	1.9	4	o				
G88 0080 050 0400 070				7.0	50	0.75	4	o	G88 0300 050 0600	-	50	2.8	6	o				
G88 0080 050 0400 080	8.0	50	0.75	4	o	G88 0300 050 0600 080 *	8	50	2.8	6	o							
G88 0080 050 0400 100	10.0	50	0.75	4	o	G88 0300 050 0600 100	10	50	2.8	6	o							
G88 0100 050 0400	-	50	0.9	4	o	G88 0300 060 0600	-	60	2.8	6	o							
G88 0100 050 0400 030	1.0	0.50	0.8	3.0	50	0.9	4	o	G88 0300 060 0600 160	16	60	2.8	6	o				
G88 0100 050 0400 040				4.0	50	0.9	4	o	G88 0300 060 0600 200	20	60	2.8	6	o				
G88 0100 050 0400 050				5.0	50	0.9	4	o	G88 0300 075 0600	-	75	2.8	6	o				
G88 0100 050 0400 060				6.0	50	0.9	4	o	G88 0300 075 0600 250	25	75	2.8	6	o				
G88 0100 050 0400 070				7.0	50	0.9	4	o	G88 0300 075 0600 300	30	75	2.8	6	o				
G88 0100 050 0400 080	8.0	50	0.9	4	o	G88 0300 075 0600 350	35	75	2.8	6	o							
G88 0100 050 0400 090	9.0	50	0.9	4	o	G88 0400 050 0600	-	50	3.7	6	o							
G88 0100 050 0400 100	10.0	50	0.9	4	o	G88 0400 050 0600 100	10	50	3.7	6	o							
G88 0100 050 0400 120	12.0	50	0.9	4	o	G88 0400 060 0600	-	60	3.7	6	o							
G88 0100 050 0400 140	14.0	50	0.9	4	o	G88 0400 060 0600 160	16	60	3.7	6	o							
G88 0100 060 0400	-	60	0.9	4	o	G88 0400 060 0600 200	20	60	3.7	6	o							
G88 0100 060 0400 200	20.0	60	0.9	4	o	G88 0400 075 0600	-	75	3.7	6	o							
G88 0120 050 0400	-	50	1.1	4	o	G88 0400 075 0600 250	25	75	3.7	6	o							
G88 0120 050 0400 060	1.2	0.60	1.0	6.0	50	1.1	4	o	G88 0400 075 0600 300	30	75	3.7	6	o				
G88 0120 050 0400 080				8.0	50	1.1	4	o	G88 0400 075 0600 350	35	75	3.7	6	o				
G88 0120 050 0400 100				10.0	50	1.1	4	o	G88 0400 100 0600	-	100	3.7	6	o				
G88 0120 050 0400 120				12.0	50	1.1	4	o	G88 0400 100 0600 400	40	100	3.7	6	o				
G88 0140 050 0400				-	50	1.3	4	o	G88 0400 100 0600 450	45	100	3.7	6	o				
G88 0140 050 0400 080	1.4	0.70	1.1	8.0	50	1.3	4	o	G88 0400 100 0600 500	50	100	3.7	6	o				
G88 0140 050 0400 120				12.0	50	1.3	4	o										
G88 0140 050 0400 160 *				16.0	50	1.3	4	o										

* - DIN 6535

Material Group | Material-Gruppe | Groupe Matiere | Gruppo Materiali | 材质主类

Cutting Parameter

N01	N02	N03	K01	K02	P01	P02	P03	M01	M02	S01	S02	S03	H01	H02	O01	O02	157 - 160
-----	-----	-----	-----	-----	-----	-----	-----	-----	-----	-----	-----	-----	-----	-----	-----	-----	-----------

Recommended Cutting Data



Note: These recommended cutting data indicators are just for reference. They should be adjusted according to the different cutting condition



NiTiCo 30 Endmills, 2 Flutes - C30, C42

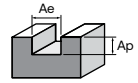

Slotting	K		P		M		S			
Working Material	Grey Cast Iron		Carbon Steel		Alloy steel		Stainless steel		Titanium	
Properties	-		-		520 < Rm < 1200		High Machinability		-	
Cutting depth, ap	0.50 x D		0.50 x D		0.50 x D		0.40 x D		0.35 x D	
Cutting Width, ae	1.00 x D		1.00 x D		0.080xD		1.00 x D		1.00 x D	
D	Vc	Fz	Vc	Fz	Vc	Fz	Vc	Fz	Vc	Fz
1	90	0.004	115	0.004	100	0.002	80	0.002	35	0.002
2		0.009		0.009		0.005		0.005		
3		0.016		0.014		0.008		0.008		
4		0.023		0.020		0.012		0.012		
5		0.030		0.027		0.016		0.016		
6		0.039		0.034		0.021		0.020		
8		0.057		0.049		0.031		0.031		
10		0.078		0.067		0.043		0.043		
12		0.101		0.087		0.057		0.057		
14		0.113		0.098		0.063		0.063		
16		0.124		0.107		0.067		0.068		
18		0.134		0.116		0.070		0.072		
20		0.143		0.123		0.072		0.075		

NiTiCo 30 Endmills, 2 Flutes - C30, C42

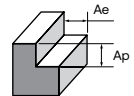

Side Milling	K		P		M		S			
Working Material	Grey Cast Iron		Carbon Steel		Alloy steel		Stainless steel		Titanium	
Properties	-		-		520 < Rm < 1200		High Machinability		-	
Cutting depth, ap	1.00 x D		1.00 x D		1.00 x D		1.00 x D		1.00 x D	
Cutting Width, ae	0.25 x D		0.25 x D		0.20 x D		0.18 x D		0.15 x D	
D	Vc	Fz	Vc	Fz	Vc	Fz	Vc	Fz	Vc	Fz
1	115	0.005	135	0.005	110	0.004	90	0.003	50	0.003
2		0.012		0.011		0.009		0.008		
3		0.019		0.018		0.015		0.013		
4		0.026		0.024		0.021		0.019		
5		0.034		0.032		0.028		0.025		
6		0.043		0.040		0.035		0.032		
8		0.061		0.058		0.051		0.048		
10		0.082		0.078		0.068		0.066		
12		0.105		0.101		0.087		0.086		
14		0.118		0.113		0.095		0.096		
16		0.129		0.124		0.104		0.104		
18		0.140		0.134		0.111		0.111		
20		0.149		0.143		0.117		0.117		

ALU LINE
 EZ LINE -
 ENDMILL
 SE 30
NITICO 30
 OPTIMUM
 SE 45
 SE 45X
 NITICO 45
 SE 60
 SE 60X
 DN70 -
 SE 70
 SE GR
 TE 45
 PLUNGE
 -MILL
 THREAD
 MILL

Recommended Cutting Data



Note: These recommended cutting data indicators are just for reference. They should be adjusted according to the different cutting condition



NiTiCo 30 Endmills, 3 Flutes - C31, C43

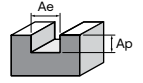

Slotting	K		P		M		S			
Working Material	Grey Cast Iron		Carbon Steel		Alloy steel		Stainless steel		Titanium	
Properties	-		-		520 < Rm < 1200		High Machinability		-	
Cutting depth, ap	0.50 x D		0.50 x D		0.50 x D		0.40 x D		0.35 x D	
Cutting Width, ae	1.00 x D		1.00 x D		1.00 x D		1.00 x D		1.00 x D	
D	Vc	Fz	Vc	Fz	Vc	Fz	Vc	Fz	Vc	Fz
1		0.003		0.003		0.001		0.001		0.001
2		0.008		0.007		0.003		0.003		0.004
3		0.013		0.011		0.006		0.006		0.007
4		0.018		0.016		0.009		0.009		0.010
5		0.023		0.020		0.012		0.011		0.015
6		0.030		0.026		0.015		0.015		0.020
8	100	0.043	125	0.038	110	0.023	90	0.022	40	0.033
10		0.059		0.052		0.032		0.031		0.049
12		0.075		0.067		0.042		0.042		0.067
14		0.086		0.075		0.046		0.047		0.070
16		0.093		0.083		0.050		0.050		0.070
18		0.100		0.089		0.053		0.052		0.071
20		0.106		0.093		0.056		0.053		0.073

NiTiCo 30 Endmills, 3 Flutes - C31, C43

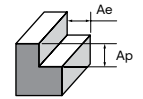

Side Milling	K		P		M		S			
Working Material	Grey Cast Iron		Carbon Steel		Alloy steel		Stainless steel		Titanium	
Properties	-		-		520 < Rm < 1200		High Machinability		-	
Cutting depth, ap	1.00 x D		1.00 x D		1.00 x D		1.00 x D		1.00 x D	
Cutting Width, ae	0.25 x D		0.25 x D		0.20 x D		0.18 x D		0.15 x D	
D	Vc	Fz	Vc	Fz	Vc	Fz	Vc	Fz	Vc	Fz
1		0.004		0.004		0.003		0.002		0.002
2		0.008		0.008		0.007		0.006		0.006
3		0.014		0.013		0.012		0.010		0.012
4		0.019		0.019		0.017		0.014		0.017
5		0.025		0.024		0.022		0.020		0.024
6		0.031		0.030		0.027		0.025		0.032
8	130	0.045	150	0.044	120	0.038	100	0.037	55	0.050
10		0.060		0.059		0.050		0.050		0.070
12		0.077		0.075		0.065		0.064		0.096
14		0.088		0.085		0.072		0.072		0.105
16		0.096		0.094		0.080		0.078		0.111
18		0.104		0.102		0.085		0.083		0.115
20		0.110		0.107		0.089		0.088		0.117

ALU LINE
ENDMILL
SE 30
NITICO 30
OPTIMUM
SE 45
SE 45X
NITICO 45
SE 60
SE 60X
DM70 - SE70
SE GR
TE 45
PLUNGE-MILL
THREAD MILL

Recommended Cutting Data



Note: These recommended cutting data indicators are just for reference. They should be adjusted according to the different cutting condition



NiTiCo 30 Endmills, 4 Flutes - C44

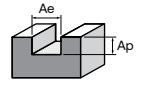

Slotting	K		P		M		S			
Working Material	Grey Cast Iron		Carbon Steel		Alloy steel		Stainless steel		Titanium	
Properties	-		-		520 < Rm < 1200		High Machinability		-	
Cutting depth, ap	1.00 × D		1.00 × D		0.80 × D		0.65 × D		0.50 × D	
Cutting Width, ae	1.00 × D		1.00 × D		1.00 × D		1.00 × D		1.00 × D	
D	Vc	Fz	Vc	Fz	Vc	Fz	Vc	Fz	Vc	Fz
1	100	0.004	125	0.003	110	0.002	90	0.002	40	0.003
2		0.008		0.007		0.004		0.004		
3		0.013		0.011		0.007		0.005		
4		0.017		0.015		0.010		0.008		
5		0.022		0.019		0.012		0.011		
6		0.028		0.024		0.015		0.015		
8		0.039		0.033		0.021		0.022		
10		0.051		0.044		0.028		0.030		
12		0.064		0.055		0.035		0.041		
14		0.073		0.061		0.039		0.046		
16		0.080		0.068		0.042		0.047		
18		0.088		0.075		0.045		0.051		
20		0.095		0.080		0.047		0.053		

NiTiCo 30 Endmills, 4 Flutes - C44

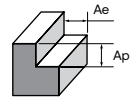

Side Milling	K		P		M		S			
Working Material	Grey Cast Iron		Carbon Steel		Alloy steel		Stainless steel		Titanium	
Properties	-		-		520 < Rm < 1200		High Machinability		-	
Cutting depth, ap	1.00 × D		1.00 × D		1.00 × D		1.00 × D		1.00 × D	
Cutting Width, ae	0.25 × D		0.25 × D		0.20 × D		0.18 × D		0.15 × D	
D	Vc	Fz	Vc	Fz	Vc	Fz	Vc	Fz	Vc	Fz
1	130	0.003	150	0.003	104	0.003	100	0.003	55	0.003
2		0.008		0.008		0.007		0.007		
3		0.013		0.013		0.023		0.025		
4		0.018		0.018		0.016		0.033		
5		0.024		0.023		0.020		0.042		
6		0.030		0.030		0.025		0.053		
8		0.042		0.041		0.064		0.065		
10		0.056		0.055		0.072		0.074		
12		0.071		0.070		0.056		0.000		
14		0.079		0.077		0.000		0.000		
16		0.086		0.084		0.000		0.000		
18		0.092		0.090		0.000		0.000		
20		0.097		0.094		0.000		0.000		

ALU LINE
 EZ LINE -
 ENDMILL
 SE 30
NITICO 30
 OPTIMUM
 SE 45
 SE 45X
 NITICO 45
 SE 60
 SE 60X
 DN70 -
 SE 70
 SE GR
 TE 45
 PLUNGE
 -MILL
 THREAD
 MILL

Recommended Cutting Data



Note: These recommended cutting data indicators are just for reference. They should be adjusted according to the different cutting condition



NiTiCo 30 Endmills, 4 Flutes - 951, 972, C46, C50

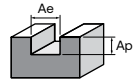

Slotting	K		P		M		S			
Working Material	Grey Cast Iron		Carbon Steel		Alloy steel		Stainless steel		Titanium	
Properties	-		-		520 < Rm < 1200		High Machinability		-	
Cutting depth, ap	1.00 × D		1.00 × D		1.00 × D		1.00 × D		0.50 × D	
Cutting Width, ae	1.00 × D		1.00 × D		1.00 × D		1.00 × D		1.00 × D	
D	Vc	Fz	Vc	Fz	Vc	Fz	Vc	Fz	Vc	Fz
1		0.003		0.003		0.002		0.003		0.004
2		0.005		0.005		0.005		0.006		0.008
3		0.008		0.008		0.008		0.009		0.013
4		0.011		0.011		0.011		0.012		0.017
5		0.015		0.015		0.014		0.016		0.023
6		0.018		0.018		0.018		0.020		0.027
8	170	0.025	200	0.025	160	0.025	120	0.028	60	0.039
10		0.033		0.033		0.033		0.037		0.052
12		0.041		0.042		0.041		0.048		0.064
14		0.048		0.047		0.047		0.054		0.074
16		0.054		0.053		0.053		0.060		0.081
18		0.058		0.058		0.058		0.065		0.086
20		0.063		0.063		0.063		0.069		0.093

NiTiCo 30 Endmills, 4 Flutes - 951, 972, C46, C50

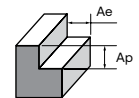

Side Milling	K		P		M		S			
Working Material	Grey Cast Iron		Carbon Steel		Alloy steel		Stainless steel		Titanium	
Properties	-		-		520 < Rm < 1200		High Machinability		-	
Cutting depth, ap	1.00 × D		1.00 × D		1.00 × D		1.00 × D		1.00 × D	
Cutting Width, ae	0.25 × D		0.25 × D		0.20 × D		0.18 × D		0.15 × D	
D	Vc	Fz	Vc	Fz	Vc	Fz	Vc	Fz	Vc	Fz
1		0.007		0.008		0.006		0.004		0.006
2		0.010		0.010		0.009		0.010		0.012
3		0.016		0.016		0.014		0.015		0.019
4		0.021		0.022		0.019		0.021		0.026
5		0.027		0.028		0.025		0.027		0.033
6		0.033		0.034		0.030		0.034		0.040
8	250	0.046	280	0.047	230	0.043	160	0.046	85	0.057
10		0.060		0.060		0.056		0.059		0.075
12		0.075		0.074		0.069		0.074		0.094
14		0.086		0.086		0.080		0.084		0.105
16		0.097		0.097		0.090		0.095		0.115
18		0.106		0.107		0.099		0.103		0.123
20		0.114		0.117		0.107		0.110		0.130

ALU LINE
EZ LINE - ENDMILL
SE 30
NITICO 30
OPTIMUM
SE 45
SE 45X
NITICO 45
SE 60
SE 60X
DM70 - SE70
SE GR
TE 45
PLUNGE -MILL
THREAD MILL

Recommended Cutting Data



Note: These recommended cutting data indicators are just for reference. They should be adjusted according to the different cutting condition



NiTiCo 30 Endmills, 4 Flutes - 951, 972, C46, C50



Ramp/Helical	K		P				M		S	
Working Material	Grey Cast Iron		Carbon Steel		Alloy steel		Stainless steel		Titanium	
Properties	-		-		520 < Rm < 1200		High Machinability		-	
Cutting depth, ap	1.00 × D		1.00 × D		1.00 × D		1.00 × D		1.00 × D	
Ramping Angle	5°		5°		5°		3°		2°	
D	Vc	Fz	Vc	Fz	Vc	Fz	Vc	Fz	Vc	Fz
3	200	0.007	200	0.007	140	0.006	70	0.006	50	0.004
4		0.010		0.010		0.009		0.010		0.006
5		0.013		0.014		0.013		0.014		0.010
6		0.016		0.017		0.016		0.019		0.013
8		0.023		0.024		0.023		0.028		0.021
10		0.030		0.032		0.031		0.038		0.030
12		0.038		0.040		0.039		0.051		0.038
14		0.043		0.046		0.045		0.058		0.042
16		0.048		0.051		0.049		0.063		0.045
18		0.051		0.056		0.053		0.064		0.047
20	0.054	0.059	0.055	0.063	0.047					

NiTiCo 30 DP/DH Torus Endmills, 4 Flutes - Long - J97, J98, H38, H39

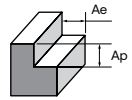

Side Milling	K		P				M		S	
Working Material	Grey Cast Iron		Carbon Steel		Alloy steel		Stainless steel		Titanium	
Properties	-		-		520 < Rm < 1200		High Machinability		-	
Cutting depth, ap	1.50 × D		1.50 × D		1.50 × D		1.50 × D		1.50 × D	
Cutting Width, ae	0.20 × D		0.20 × D		0.15 × D		0.13 × D		0.10 × D	
D	Vc	Fz	Vc	Fz	Vc	Fz	Vc	Fz	Vc	Fz
4	220	0.020	250	0.021	200	0.018	140	0.020	70	0.026
5		0.026		0.027		0.023		0.026		0.033
6		0.033		0.032		0.029		0.031		0.041
8		0.044		0.044		0.040		0.041		0.056
10		0.057		0.056		0.051		0.053		0.072
12		0.069		0.067		0.065		0.066		0.089
16		0.086		0.084		0.080		0.081		0.113
20		0.102		0.102		0.090		0.093		0.135

NiTiCo 30 DH Endmills, 5 Flutes - J89, J90

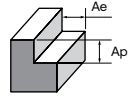

Side Milling	K		P				M		S	
Working Material	Grey Cast Iron		Carbon Steel		Alloy steel		Stainless steel		Titanium	
Properties	-		-		520 < Rm < 1200		High Machinability		-	
Cutting depth, ap	1.00 × D		1.00 × D		1.00 × D		1.00 × D		1.00 × D	
Cutting Width, ae	0.25 × D		0.25 × D		0.20 × D		0.18 × D		0.15 × D	
D	Vc	Fz	Vc	Fz	Vc	Fz	Vc	Fz	Vc	Fz
4	250	0.017	280	0.018	230	0.018	160	0.018	85	0.024
5		0.022		0.023		0.022		0.023		0.030
6		0.027		0.028		0.027		0.028		0.037
8		0.036		0.038		0.038		0.039		0.051
10		0.049		0.048		0.049		0.050		0.065
12		0.059		0.057		0.062		0.063		0.081
16		0.077		0.074		0.076		0.077		0.103
20		0.086		0.089		0.086		0.088		0.122

ALU LINE
EZ LINE -
ENDMILL
SE 30
NITICO 30
OPTIMUM
SE 45
SE 45X
NITICO 45
SE 60
SE 60X
DN70 -
SE 70
SE GR
TE 45
PLUNGE
MILL
THREAD
MILL

Recommended Cutting Data



Note: These recommended cutting data indicators are just for reference. They should be adjusted according to the different cutting condition



NiTiCo 30 DH Endmills, 5 Flutes - J89, J90

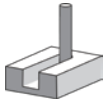

Trochoidal Milling	K		P		M		S			
Working Material	Grey Cast Iron		Carbon Steel		Alloy steel		Stainless steel		Titanium	
Properties	-		-		520 < Rm < 1200		High Machinability		-	
Maximum Slot Width	1.25 × D		1.25 × D		1.25 × D		1.25 × D		1.25 × D	
Cutting depth, ap	1.50 × D		1.50 × D		1.50 × D		1.50 × D		1.50 × D	
Cutting Width, ae	0.15 × D		0.15 × D		0.12 × D		0.10 × D		0.10 × D	
D	Vc	Fz	Vc	Fz	Vc	Fz	Vc	Fz	Vc	Fz
4	300	0.015	330	0.015	280	0.016	200	0.017	110	0.024
5		0.021		0.020		0.022		0.023		0.031
6		0.027		0.028		0.030		0.031		0.038
8		0.038		0.039		0.043		0.044		0.054
10		0.051		0.051		0.058		0.059		0.071
12		0.064		0.064		0.078		0.079		0.092
16		0.080		0.082		0.095		0.096		0.115
20		0.094		0.093		0.108		0.109		0.135

NiTiCo 30 Endmills, 5 Flutes - Long - J92, J93

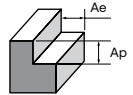

Side Milling	K		P		M		S			
Working Material	Grey Cast Iron		Carbon Steel		Alloy steel		Stainless steel		Titanium	
Properties	-		-		520 < Rm < 1200		High Machinability		-	
Cutting depth, ap	1.50 × D		1.50 × D		1.50 × D		1.50 × D		1.50 × D	
Cutting Width, ae	0.15 × D		0.15 × D		0.12 × D		0.10 × D		0.10 × D	
D	Vc	Fz	Vc	Fz	Vc	Fz	Vc	Fz	Vc	Fz
4	230	0.014	260	0.015	210	0.016	140	0.017	75	0.023
5		0.019		0.019		0.020		0.021		0.029
6		0.024		0.023		0.025		0.027		0.036
8		0.031		0.032		0.035		0.037		0.049
10		0.041		0.041		0.046		0.048		0.063
12		0.053		0.050		0.057		0.060		0.078
16		0.066		0.062		0.071		0.074		0.099
20		0.078		0.073		0.080		0.085		0.119

NiTiCo 30 Endmills, 5 Flutes - Long - J92, J93

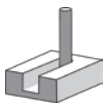

Trochoidal Milling	K		P		M		S			
Working Material	Grey Cast Iron		Carbon Steel		Alloy steel		Stainless steel		Titanium	
Properties	-		-		520 < Rm < 1200		High Machinability		-	
Maximum Slot Width	1.25 × D		1.25 × D		1.25 × D		1.25 × D		1.25 × D	
Cutting depth, ap	2.00 × D		2.00 × D		2.00 × D		2.00 × D		2.00 × D	
Cutting Width, ae	0.12 × D		0.12 × D		0.10 × D		0.08 × D		0.08 × D	
D	Vc	Fz	Vc	Fz	Vc	Fz	Vc	Fz	Vc	Fz
4	270	0.014	300	0.014	260	0.014	170	0.016	95	0.021
5		0.018		0.018		0.020		0.022		0.027
6		0.023		0.025		0.027		0.029		0.035
8		0.034		0.035		0.040		0.042		0.049
10		0.047		0.046		0.054		0.056		0.065
12		0.061		0.059		0.070		0.071		0.083
16		0.068		0.068		0.089		0.090		0.106
20		0.080		0.078		0.101		0.103		0.126

Recommended Cutting Data



Note: These recommended cutting data indicators are just for reference. They should be adjusted according to the different cutting condition



NiTiCo 30 Roughing Endmills, 4 Flutes - C47, C64

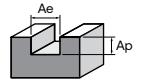

Slotting	K		P		M		S			
Working Material	Grey Cast Iron		Carbon Steel		Alloy steel		Stainless steel		Titanium	
Properties	-		-		520 < Rm < 1200		High Machinability		-	
Cutting depth, ap	1.00 × D		1.00 × D		1.00 × D		1.00 × D		0.50 × D	
Cutting Width, ae	1.00 × D		1.00 × D		1.00 × D		1.00 × D		1.00 × D	
D	Vc	Fz	Vc	Fz	Vc	Fz	Vc	Fz	Vc	Fz
6	190	0.020	220	0.020	175	0.020	130	0.022	65	0.032
8		0.027		0.027		0.027		0.030		0.042
10		0.035		0.035		0.035		0.039		0.054
12		0.043		0.043		0.042		0.048		0.067
14		0.049		0.050		0.048		0.055		0.076
16		0.056		0.057		0.054		0.062		0.085
18		0.062		0.063		0.060		0.068		0.093
20		0.069		0.069		0.066		0.075		0.102

NiTiCo 30 Roughing Endmills, 4 Flutes - C47, C64

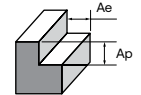

Side Milling	K		P		M		S			
Working Material	Grey Cast Iron		Carbon Steel		Alloy steel		Stainless steel		Titanium	
Properties	-		-		520 < Rm < 1200		High Machinability		-	
Cutting depth, ap	1.00 × D		1.00 × D		1.00 × D		1.00 × D		1.00 × D	
Cutting Width, ae	0.25 × D		0.25 × D		0.20 × D		0.18 × D		0.15 × D	
D	Vc	Fz	Vc	Fz	Vc	Fz	Vc	Fz	Vc	Fz
6	275	0.035	310	0.037	255	0.034	175	0.036	95	0.043
8		0.048		0.050		0.046		0.048		0.059
10		0.060		0.063		0.059		0.061		0.075
12		0.075		0.076		0.072		0.075		0.093
14		0.086		0.087		0.084		0.086		0.106
16		0.095		0.096		0.093		0.095		0.119
18		0.103		0.105		0.102		0.103		0.131
20		0.113		0.116		0.111		0.113		0.141

NiTiCo 30 DH Endmills, with Internal Oil Hole, Chip Breaker, Recess and Weldon, 5 flutes - K65

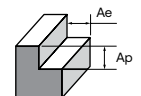

Side Milling	K		P		M		S			
Working Material	Grey Cast Iron		Carbon Steel		Alloy steel		Stainless steel		Titanium	
Properties	-		-		520 < Rm < 1200		High Machinability		-	
Cutting depth, ap	1.00 × D		1.00 × D		1.00 × D		1.00 × D		1.00 × D	
Cutting Width, ae	0.25 × D		0.25 × D		0.20 × D		0.18 × D		0.15 × D	
D	Vc	Fz	Vc	Fz	Vc	Fz	Vc	Fz	Vc	Fz
4	280	0.016	310	0.017	250	0.019	180	0.021	100	0.025
5		0.021		0.022		0.025		0.027		0.032
6		0.025		0.027		0.031		0.033		0.039
8		0.035		0.036		0.043		0.045		0.054
10		0.045		0.046		0.055		0.057		0.069
12		0.056		0.056		0.069		0.071		0.087
16		0.071		0.072		0.087		0.089		0.108
20		0.084		0.088		0.107		0.109		0.128

ALU LINE
 EZ LINE -
 ENDMILL
 SE 30
 NITICO 30
 OPTIMUM
 SE 45
 SE 45X
 NITICO 45
 SE 60
 SE 60X
 DN70 -
 SE 70
 SE GR
 TE 45
 PLUNGE
 -MILL
 THREAD
 MILL

Recommended Cutting Data



Note: These recommended cutting data indicators are just for reference. They should be adjusted according to the different cutting condition



NiTiCo 30 DH Endmills, with Internal Oil Hole, Chip Breaker, Recess and Weldon, 5 flutes - K65

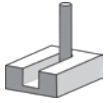

Trochoidal Milling	K		P		M		S			
Working Material	Grey Cast Iron		Carbon Steel		Alloy steel		Stainless steel		Titanium	
Properties	-		-		520 < Rm < 1200		High Machinability		-	
Maximum Slot Width	1.25 × D		1.25 × D		1.25 × D		1.25 × D		1.25 × D	
Cutting depth, ap	1.50 × D		1.50 × D		1.50 × D		1.50 × D		1.50 × D	
Cutting Width, ae	0.15 × D		0.15 × D		0.12 × D		0.10 × D		0.10 × D	
D	Vc	Fz	Vc	Fz	Vc	Fz	Vc	Fz	Vc	Fz
4	330	0.015	360	0.016	300	0.017	220	0.019	130	0.025
5		0.020		0.021		0.023		0.025		0.032
6		0.026		0.027		0.031		0.033		0.040
8		0.037		0.037		0.044		0.046		0.055
10		0.049		0.049		0.059		0.061		0.072
12		0.063		0.064		0.078		0.080		0.096
16		0.078		0.079		0.097		0.099		0.117
20		0.089		0.089		0.110		0.112		0.138

NiTiCo 30 DH Long Endmills, with Internal Oil Hole, Chip Breaker, Recess and Weldon 5 flutes - K67

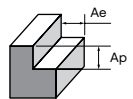

Side Milling	K		P		M		S			
Working Material	Grey Cast Iron		Carbon Steel		Alloy steel		Stainless steel		Titanium	
Properties	-		-		520 < Rm < 1200		High Machinability		-	
Cutting depth, ap	1.50 × D		1.50 × D		1.50 × D		1.50 × D		1.50 × D	
Cutting Width, ae	0.15 × D		0.15 × D		0.12 × D		0.10 × D		0.10 × D	
D	Vc	Fz	Vc	Fz	Vc	Fz	Vc	Fz	Vc	Fz
4	250	0.014	280	0.014	230	0.018	160	0.020	85	0.020
5		0.019		0.019		0.023		0.025		0.027
6		0.023		0.024		0.029		0.031		0.035
8		0.031		0.032		0.039		0.041		0.050
10		0.040		0.041		0.050		0.052		0.066
12		0.053		0.054		0.063		0.065		0.084
16		0.068		0.069		0.082		0.084		0.107
20		0.080		0.083		0.099		0.101		0.126

NiTiCo 30 DH Long Endmills, with Internal Oil Hole, Chip Breaker, Recess and Weldon 5 flutes - K67

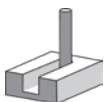

Trochoidal Milling	K		P		M		S			
Working Material	Grey Cast Iron		Carbon Steel		Alloy steel		Stainless steel		Titanium	
Properties	-		-		520 < Rm < 1200		High Machinability		-	
Maximum Slot Width	1.25 × D		1.25 × D		1.25 × D		1.25 × D		1.25 × D	
Cutting depth, ap	2.00 × D		2.00 × D		2.00 × D		2.00 × D		2.00 × D	
Cutting Width, ae	0.12 × D		0.12 × D		0.10 × D		0.08 × D		0.08 × D	
D	Vc	Fz	Vc	Fz	Vc	Fz	Vc	Fz	Vc	Fz
4	300	0.013	330	0.014	280	0.014	200	0.016	115	0.021
5		0.018		0.019		0.021		0.023		0.028
6		0.024		0.025		0.028		0.030		0.035
8		0.034		0.035		0.040		0.042		0.049
10		0.045		0.046		0.055		0.057		0.066
12		0.059		0.060		0.072		0.074		0.089
16		0.072		0.074		0.088		0.090		0.107
20		0.081		0.082		0.099		0.101		0.123

ALU LINE
ENDMILL
SE 30
NITICO 30
OPTIMUM
SE 45
SE 45X
NITICO 45
SE 60
SE 60X
DM70 - SE70
SE GR
TE 45
PLUNGE-MILL
THREAD MILL

Recommended Cutting Data



Note: These recommended cutting data indicators are just for reference. They should be adjusted according to the different cutting condition



NiTiCo 30 DP/DH Endmills, 4 Flutes - 949, C49, K78, C48, C52, A1R, A1T, H98, J01

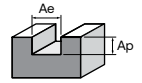

Slotting	K		P		M		S			
Working Material	Grey Cast Iron		Carbon Steel		Alloy steel		Stainless steel		Titanium	
Properties	-		-		520 < Rm < 1200		High Machinability		-	
Cutting depth, ap	1.00 × D		1.00 × D		1.00 × D		1.00 × D		0.50 × D	
Cutting Width, ae	1.00 × D		1.00 × D		1.00 × D		1.00 × D		1.00 × D	
D	Vc	Fz	Vc	Fz	Vc	Fz	Vc	Fz	Vc	Fz
1	170	0.003	200	0.003	160	0.003	120	0.003	60	0.004
2		0.006		0.005		0.006		0.006		
3		0.009		0.009		0.009		0.009		
4		0.012		0.012		0.012		0.013		
5		0.016		0.015		0.015		0.017		
6		0.019		0.019		0.019		0.021		
8		0.027		0.027		0.027		0.031		
10		0.037		0.036		0.036		0.041		
12		0.046		0.046		0.045		0.053		
14		0.053		0.053		0.052		0.060		
16		0.058		0.058		0.058		0.066		
18		0.064		0.064		0.064		0.071		
20		0.069		0.069		0.069		0.076		

NiTiCo 30 DP/DH Endmills, 4 Flutes - 949, C49, K78, C48, C52, A1R, A1T, H98, J01

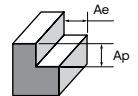

Side Milling	K		P		M		S			
Working Material	Grey Cast Iron		Carbon Steel		Alloy steel		Stainless steel		Titanium	
Properties	-		-		520 < Rm < 1200		High Machinability		-	
Cutting depth, ap	1.00 × D		1.00 × D		1.00 × D		1.00 × D		1.00 × D	
Cutting Width, ae	0.25 × D		0.25 × D		0.20 × D		0.18 × D		0.15 × D	
D	Vc	Fz	Vc	Fz	Vc	Fz	Vc	Fz	Vc	Fz
1	250	0.008	280	0.009	230	0.007	160	0.006	85	0.007
2		0.010		0.010		0.010		0.012		
3		0.016		0.016		0.015		0.018		
4		0.022		0.022		0.021		0.025		
5		0.029		0.029		0.027		0.031		
6		0.035		0.035		0.033		0.038		
8		0.050		0.050		0.047		0.052		
10		0.066		0.066		0.061		0.067		
12		0.083		0.083		0.077		0.082		
14		0.095		0.095		0.088		0.093		
16		0.106		0.107		0.099		0.103		
18		0.116		0.118		0.109		0.112		
20		0.126		0.129		0.118		0.121		

ALU LINE
 EZ LINE -
 ENDMILL
 SE 30
NITICO 30
 OPTIMUM
 SE 45
 SE 45X
 NITICO 45
 SE 60
 SE 60X
 DN70 -
 SE 70
 SE GR
 TE 45
 PLUNGE
 -MILL
 THREAD
 MILL

Recommended Cutting Data



Note: These recommended cutting data indicators are just for reference. They should be adjusted according to the different cutting condition



NiTiCo 30 DP/DH Endmills, 4 Flutes - 949, C49, K78, C48, C52, A1R, A1T, H98, J01



Ramp/Helical	K		P		M		S			
Working Material	Grey Cast Iron		Carbon Steel		Alloy steel		Stainless steel		Titanium	
Properties	-		-		520 < Rm < 1200		High Machinability		-	
Cutting depth, ap	1.00 × D		1.00 × D		1.00 × D		1.00 × D		1.00 × D	
Ramping Angle	5°		5°		5°		3°		2°	
D	Vc	Fz	Vc	Fz	Vc	Fz	Vc	Fz	Vc	Fz
3	200	0.008	200	0.009	140	0.008	70	0.008	50	0.005
4		0.011		0.012		0.011		0.012		0.008
5		0.014		0.016		0.014		0.016		0.011
6		0.018		0.020		0.018		0.020		0.014
8		0.025		0.028		0.026		0.031		0.021
10		0.033		0.037		0.034		0.043		0.031
12		0.042		0.046		0.043		0.058		0.041
14		0.047		0.052		0.049		0.063		0.046
16		0.052		0.057		0.054		0.067		0.049
18		0.056		0.061		0.058		0.069		0.052
20		0.060		0.065		0.062		0.070		0.053

NiTiCo 30 DP/DH Endmills, 4 Flutes - 949, C49, K78, C48, C52, A1R, A1T, H98, J01

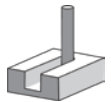

Trochoidal Milling	K		P		M		S			
Working Material	Grey Cast Iron		Carbon Steel		Alloy steel		Stainless steel		Titanium	
Properties	-		-		520 < Rm < 1200		High Machinability		-	
Maximum Slot Width	1.25 × D		1.25 × D		1.25 × D		1.25 × D		1.25 × D	
Cutting depth, ap	1.50 × D		1.50 × D		1.50 × D		1.50 × D		1.50 × D	
Cutting Width, ae	0.15 × D		0.15 × D		0.15 × D		0.10 × D		0.10 × D	
D	Vc	Fz	Vc	Fz	Vc	Fz	Vc	Fz	Vc	Fz
4	330	0.021	360	0.023	300	0.019	220	0.024	130	0.024
5		0.027		0.029		0.025		0.030		0.031
6		0.034		0.037		0.032		0.037		0.039
8		0.049		0.051		0.047		0.051		0.055
10		0.065		0.067		0.063		0.067		0.074
12		0.087		0.089		0.085		0.090		0.101
14		0.093		0.095		0.090		0.095		0.106
16		0.098		0.102		0.095		0.100		0.111
18		0.104		0.108		0.100		0.110		0.120
20		0.110		0.114		0.106		0.116		0.126

ALU LINE
EZ LINE - ENDMILL
SE 30
NITICO 30
OPTIMUM
SE 45
SE 45X
NITICO 45
SE 60
SE 60X
DM70 - SE70
SE GR
TE 45
PLUNGE -MILL
THREAD MILL

Recommended Cutting Data



Note: These recommended cutting data indicators are just for reference. They should be adjusted according to the different cutting condition



NiTiCo 30 DP/DH OH Standard Endmills, 4 Flutes - K70

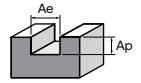

Slotting	K		P		M		S			
Working Material	Grey Cast Iron		Carbon Steel		Alloy steel		Stainless steel		Titanium	
Properties	-		-		520 < Rm < 1200		High Machinability		-	
Cutting depth, ap	1.00 × D		1.00 × D		1.00 × D		1.00 × D		0.50 × D	
Cutting Width, ae	1.00 × D		1.00 × D		1.00 × D		1.00 × D		1.00 × D	
D	Vc	Fz	Vc	Fz	Vc	Fz	Vc	Fz	Vc	Fz
4	200	0.015	230	0.015	190	0.014	140	0.016	75	0.020
5		0.019		0.019		0.018		0.020		0.026
6		0.023		0.024		0.022		0.024		0.032
8		0.031		0.032		0.030		0.033		0.043
10		0.040		0.040		0.038		0.041		0.055
12		0.049		0.049		0.047		0.052		0.069
16		0.064		0.065		0.062		0.067		0.091
20		0.079		0.080		0.077		0.080		0.111

NiTiCo 30 DP/DH OH Standard Endmills, 4 Flutes - K70

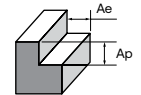

Side Milling	K		P		M		S			
Working Material	Grey Cast Iron		Carbon Steel		Alloy steel		Stainless steel		Titanium	
Properties	-		-		520 < Rm < 1200		High Machinability		-	
Cutting depth, ap	1.00 × D		1.00 × D		1.00 × D		1.00 × D		1.00 × D	
Cutting Width, ae	0.25 × D		0.25 × D		0.20 × D		0.18 × D		0.15 × D	
D	Vc	Fz	Vc	Fz	Vc	Fz	Vc	Fz	Vc	Fz
4	280	0.020	310	0.023	260	0.018	180	0.023	100	0.025
5		0.027		0.030		0.025		0.031		0.033
6		0.034		0.037		0.032		0.038		0.041
8		0.049		0.051		0.047		0.053		0.057
10		0.065		0.068		0.063		0.070		0.072
12		0.084		0.087		0.083		0.089		0.099
16		0.107		0.109		0.105		0.113		0.118
20		0.123		0.127		0.121		0.131		0.137

NiTiCo 30 DP/DH OH Standard Endmills, 4 Flutes - K70

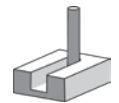

Trochoidal Milling	K		P		M		S			
Working Material	Grey Cast Iron		Carbon Steel		Alloy steel		Stainless steel		Titanium	
Properties	-		-		520 < Rm < 1200		High Machinability		-	
Maximum Slot Width	1.25 × D		1.25 × D		1.25 × D		1.25 × D		1.25 × D	
Cutting depth, ap	1.50 × D		1.50 × D		1.50 × D		1.50 × D		1.50 × D	
Cutting Width, ae	0.15 × D		0.15 × D		0.15 × D		0.10 × D		0.10 × D	
D	Vc	Fz	Vc	Fz	Vc	Fz	Vc	Fz	Vc	Fz
4	330	0.021	360	0.023	300	0.019	220	0.024	130	0.024
5		0.027		0.029		0.025		0.030		0.031
6		0.034		0.037		0.032		0.037		0.039
8		0.049		0.051		0.047		0.051		0.055
10		0.065		0.067		0.063		0.067		0.074
12		0.087		0.089		0.085		0.090		0.101
14		0.093		0.095		0.090		0.095		0.106
16		0.098		0.102		0.095		0.100		0.111
18	0.104	0.108	0.100	0.110	0.120					
20	0.110	0.114	0.106	0.116	0.126					

ALU LINE
 EZ LINE - ENDMILL
 SE 30
 NITICO 30
 OPTIMUM
 SE 45
 SE 45X
 NITICO 45
 SE 60
 SE 60X
 DN70 - SE 70
 SE GR
 TE 45
 PLUNGE -MILL
 THREAD MILL

Recommended Cutting Data



Note: These recommended cutting data indicators are just for reference. They should be adjusted according to the different cutting condition



NiTiCo 30 Miniature Endmills with Long Neck, 2 Flutes - G87, H56

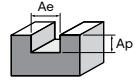

Slotting		K			P					
Working Material		Grey Cast Iron			Carbon Steel			Alloy steel		
Properties		-			-			520 < Rm < 1200		
D	Effective Length	Ap	N	Fz	Ap	N	Fz	Ap	N	Fz
0.2	1.0	0.013	42750	0.007						
	2.0	0.013	42750	0.007						
0.3	1.0	0.020	38000	0.008	0.021	40000	0.008	0.021	36800	0.007
	2.0	0.011	34200	0.006	0.012	36000	0.007	0.012	33120	0.006
	3.0	0.008	34200	0.006	0.008	36000	0.007	0.008	33120	0.006
0.4	2.0	0.027	30400	0.011	0.028	32000	0.011	0.028	29440	0.010
	3.0	0.015	27360	0.010	0.016	28800	0.010	0.016	26500	0.009
	4.0	0.010	27360	0.010	0.010	28800	0.010	0.010	26500	0.009
	5.0	0.010	24320	0.008	0.010	25600	0.009	0.010	23550	0.008
0.5	2.0	0.033	30400	0.010	0.035	32000	0.011	0.035	29440	0.010
	4.0	0.019	27360	0.010	0.020	28800	0.010	0.020	26500	0.009
	6.0	0.012	24320	0.008	0.013	25600	0.009	0.013	23550	0.008
0.6	8.0	0.008	24320	0.007	0.008	25600	0.008	0.008	23550	0.007
	2.0	0.040	30400	0.015	0.042	32000	0.016	0.042	29440	0.015
	4.0	0.023	27360	0.014	0.024	28800	0.014	0.024	26500	0.013
0.7	6.0	0.014	27360	0.014	0.015	28800	0.014	0.015	26500	0.013
	8.0	0.014	24320	0.012	0.015	25600	0.013	0.015	23550	0.012
	10.0	0.009	24320	0.012	0.009	25600	0.013	0.009	23550	0.012
0.8	2.0	0.067	30400	0.015	0.070	32000	0.016	0.070	29440	0.015
	4.0	0.047	27360	0.014	0.049	28800	0.014	0.049	26500	0.013
	6.0	0.017	27360	0.014	0.018	28800	0.014	0.018	26500	0.013
	8.0	0.017	24320	0.012	0.018	25600	0.013	0.018	23550	0.012
0.9	10.0	0.017	24320	0.012	0.018	25600	0.013	0.018	23550	0.012
	4.0	0.076	30400	0.015	0.080	32000	0.016	0.080	29440	0.015
	6.0	0.053	30400	0.012	0.056	32000	0.013	0.056	29440	0.012
	8.0	0.030	27360	0.014	0.032	28800	0.014	0.032	26500	0.013
1.0	10.0	0.019	24320	0.012	0.020	25600	0.013	0.020	23550	0.012
	12.0	0.011	24320	0.012	0.012	25600	0.013	0.012	23550	0.012
	6.0	0.034	27360	0.016	0.036	28800	0.017	0.036	26500	0.016
	8.0	0.022	27360	0.015	0.023	28800	0.016	0.023	26500	0.015
1.2	10.0	0.022	24320	0.012	0.023	25600	0.013	0.023	23550	0.012
	15.0	0.017	23750	0.010	0.018	25000	0.010	0.018	23000	0.009
	6.0	0.038	24620	0.019	0.040	25920	0.020	0.040	23850	0.019
	8.0	0.038	24620	0.017	0.040	25920	0.018	0.040	23850	0.017
1.4	10.0	0.024	23750	0.014	0.025	25000	0.015	0.025	23000	0.014
	12.0	0.024	21890	0.018	0.025	23040	0.019	0.025	21200	0.017
	14.0	0.024	21890	0.018	0.025	23040	0.019	0.025	21200	0.017
	16.0	0.014	21890	0.012	0.015	23040	0.013	0.015	21200	0.012
1.5	6.0	0.080	24320	0.020	0.084	25600	0.021	0.084	23550	0.020
	8.0	0.046	21890	0.021	0.048	23040	0.022	0.048	21200	0.020
	10.0	0.029	21890	0.021	0.030	23040	0.022	0.030	21200	0.020
1.5	12.0	0.029	21890	0.018	0.030	23040	0.019	0.030	21200	0.017
	6.0	0.095	21280	0.024	0.100	22400	0.026	0.100	20610	0.024
	8.0	0.057	20950	0.023	0.060	22050	0.024	0.060	20290	0.022
	10.0	0.048	19700	0.024	0.050	20740	0.025	0.050	19080	0.023
	12.0	0.033	19150	0.020	0.035	20160	0.022	0.035	18550	0.020
	14.0	0.033	20430	0.019	0.035	21500	0.020	0.035	19780	0.019
	16.0	0.026	18050	0.016	0.027	19000	0.017	0.027	17480	0.016
6.0	0.105	21280	0.025	0.110	22400	0.026	0.110	20610	0.024	
1.5	8.0	0.076	19150	0.026	0.080	20160	0.027	0.080	18550	0.025
	10.0	0.057	19150	0.025	0.06	20160	0.026	0.06	18550	0.024
	12.0	0.057	19150	0.020	0.060	20160	0.022	0.060	18550	0.020
	14.0	0.036	19150	0.020	0.038	20160	0.022	0.038	18550	0.020
	16.0	0.036	17020	0.018	0.038	17920	0.019	0.038	16490	0.017
	18.0	0.036	17020	0.018	0.038	17920	0.019	0.038	16490	0.017
20.0	0.036	17020	0.018	0.038	17920	0.019	0.038	16490	0.017	

cont'd ▶

Recommended Cutting Data



Note: These recommended cutting data indicators are just for reference. They should be adjusted according to the different cutting condition



NiTiCo 30 Miniature Endmills with Long Neck, 2 Flutes - G87, H56

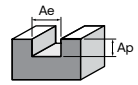

Slotting		K			P					
Working Material		Grey Cast Iron			Carbon Steel			Alloy steel		
Properties		-			-			520 < Rm < 1200		
D	Effective Length	Ap	N	Fz	Ap	N	Fz	Ap	N	Fz
1.6	6.0	0.105	19760	0.027	0.110	20800	0.028	0.110	19140	0.026
	8.0	0.105	19760	0.026	0.110	20800	0.028	0.110	19140	0.025
	10.0	0.081	17230	0.028	0.085	18140	0.030	0.085	16690	0.027
	12.0	0.076	17580	0.023	0.080	18500	0.024	0.080	17020	0.022
	14.0	0.057	18240	0.023	0.060	19200	0.024	0.060	17660	0.022
	16.0	0.048	16150	0.020	0.050	17000	0.021	0.050	15640	0.019
	18.0	0.043	16060	0.020	0.045	16900	0.021	0.045	15550	0.019
	20.0	0.043	16010	0.020	0.045	16850	0.021	0.045	15500	0.019
1.8	6.0	0.124	19760	0.027	0.130	20800	0.029	0.130	19140	0.026
	8.0	0.124	19760	0.026	0.130	20800	0.028	0.130	19140	0.025
	10.0	0.114	17580	0.028	0.120	18500	0.029	0.120	17020	0.027
	12.0	0.076	16630	0.024	0.080	17500	0.026	0.080	16100	0.024
	14.0	0.043	16150	0.025	0.045	17000	0.026	0.045	15640	0.024
	16.0	0.060	15580	0.022	0.063	16400	0.023	0.063	15090	0.022
	18.0	0.052	15110	0.022	0.055	15900	0.024	0.055	14630	0.022
	20.0	0.046	14730	0.021	0.048	15500	0.022	0.048	14260	0.020
2.0	6.0	0.190	15960	0.032	0.200	16800	0.033	0.200	15460	0.031
	8.0	0.133	15960	0.033	0.140	16800	0.035	0.140	15460	0.032
	10.0	0.133	15960	0.033	0.140	16800	0.035	0.140	15460	0.032
	12.0	0.095	15300	0.028	0.100	16100	0.030	0.100	14810	0.027
	14.0	0.076	15300	0.028	0.080	16100	0.030	0.080	14810	0.027
	16.0	0.076	14360	0.029	0.080	15120	0.030	0.080	13910	0.028
	18.0	0.048	14360	0.029	0.050	15120	0.030	0.050	13910	0.028
	20.0	0.048	14360	0.027	0.050	15120	0.029	0.050	13910	0.026
	25.0	0.048	12770	0.024	0.050	13440	0.025	0.050	12360	0.023
	30.0	0.029	12770	0.024	0.030	13440	0.025	0.030	12360	0.023
2.5	8.0	0.171	13680	0.045	0.180	14400	0.047	0.180	13250	0.043
	10.0	0.138	15390	0.038	0.145	16200	0.040	0.145	14900	0.037
	12.0	0.171	13680	0.041	0.180	14400	0.043	0.180	13250	0.040
	14.0	0.090	14060	0.037	0.095	14800	0.039	0.095	13620	0.036
	16.0	0.095	12310	0.039	0.100	12960	0.041	0.100	11920	0.038
	18.0	0.095	12310	0.036	0.100	12960	0.038	0.100	11920	0.035
	20.0	0.095	12310	0.034	0.100	12960	0.036	0.100	11920	0.033
	25.0	0.062	11400	0.030	0.065	12000	0.031	0.065	11040	0.029
	30.0	0.057	10940	0.030	0.060	11520	0.031	0.060	10600	0.029
	3.0	8.0	0.285	12160	0.046	0.300	12800	0.048	0.300	11780
10.0		0.147	15200	0.045	0.155	16000	0.047	0.155	14720	0.043
12.0		0.200	12160	0.041	0.210	12800	0.043	0.210	11780	0.040
14.0		0.095	13300	0.033	0.100	14000	0.035	0.100	12880	0.032
16.0		0.143	10940	0.040	0.150	11520	0.042	0.150	10600	0.039
18.0		0.128	10940	0.038	0.135	11520	0.040	0.135	10600	0.037
20.0		0.114	10940	0.038	0.120	11520	0.039	0.120	10600	0.036
25.0		0.076	10940	0.038	0.080	11520	0.039	0.080	10600	0.036
4.0	10.0	0.152	14920	0.057	0.160	15700	0.060	0.160	14440	0.055
	15.0	0.152	12350	0.062	0.160	13000	0.065	0.160	11960	0.060
	20.0	0.266	8040	0.095	0.280	8460	0.100	0.280	7780	0.092
	25.0	0.152	8040	0.086	0.160	8460	0.090	0.160	7780	0.083
	30.0	0.152	8040	0.085	0.160	8460	0.090	0.160	7780	0.083
40.0	0.095	7240	0.085	0.100	7620	0.090	0.100	7010	0.083	

ALU LINE
EZ LINE -
ENDMILL
SE 30
NITICO 30
OPTIMUM
SE 45
SE 45X
NITICO 45
SE 60
SE 60X
DN70 -
SE 70
SE GR
TE 45
PLUNGE
-MILL
THREAD
MILL

Recommended Cutting Data



Note: These recommended cutting data indicators are just for reference. They should be adjusted according to the different cutting condition



NiTiCo 30 Miniature Endmills with Long Neck, 2 Flutes - G87, H56

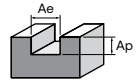

Slotting		M			S					
Working Material		Stainless steel			Titanium			Cobalt Alloy		
Properties		High Machinability			-			-		
D	Effective Length	Ap	N	Fz	Ap	N	Fz	Ap	N	Fz
0.2	1.0	0.013	40500	0.007		39600	0.004	0.013	35640	0.004
	2.0	0.019	36000	0.008	0.019	35200	0.004	0.019	31680	0.004
0.3	1.0	0.011	32400	0.006	0.011	31680	0.004	0.011	28510	0.003
	2.0	0.007	32400	0.006	0.007	31680	0.004	0.007	28510	0.003
	3.0	0.025	28800	0.011	0.025	28160	0.006	0.025	25340	0.005
0.4	2.0	0.014	25920	0.010	0.014	25340	0.006	0.014	22810	0.005
	3.0	0.009	25920	0.010	0.009	25340	0.006	0.009	22810	0.005
	4.0	0.009	23040	0.009	0.009	22530	0.005	0.009	20280	0.004
0.5	2.0	0.032	28800	0.011	0.032	28160	0.006	0.032	25340	0.005
	4.0	0.018	25920	0.010	0.018	25340	0.006	0.018	22810	0.005
	6.0	0.012	23040	0.009	0.012	22530	0.005	0.012	20280	0.004
0.6	8.0	0.007	23040	0.008	0.007	22530	0.004	0.007	20280	0.004
	2.0	0.038	28800	0.016	0.038	28160	0.009	0.038	25340	0.008
	4.0	0.022	25920	0.014	0.022	25340	0.008	0.022	22810	0.007
0.7	6.0	0.014	25920	0.014	0.014	25340	0.008	0.014	22810	0.007
	8.0	0.014	23040	0.013	0.014	22530	0.007	0.014	20280	0.006
	10.0	0.008	23040	0.013	0.008	22530	0.007	0.008	20280	0.006
0.8	2.0	0.063	28800	0.016	0.063	28160	0.009	0.063	25340	0.008
	4.0	0.044	25920	0.014	0.044	25340	0.008	0.044	22810	0.007
	6.0	0.016	25920	0.014	0.016	25340	0.008	0.016	22810	0.007
0.9	8.0	0.016	23040	0.013	0.016	22530	0.007	0.016	20280	0.006
	10.0	0.016	23040	0.013	0.016	22530	0.007	0.016	20280	0.006
	4.0	0.072	28800	0.016	0.072	28160	0.009	0.072	25340	0.008
1.0	6.0	0.050	25920	0.014	0.050	28160	0.007	0.050	25340	0.006
	8.0	0.029	25920	0.014	0.029	25340	0.008	0.029	22810	0.007
	10.0	0.018	23040	0.013	0.018	22530	0.007	0.018	20280	0.006
1.2	12.0	0.011	23040	0.013	0.011	22530	0.007	0.011	20280	0.006
	6.0	0.032	25920	0.017	0.032	25340	0.009	0.032	22810	0.009
	8.0	0.021	25920	0.016	0.021	25340	0.009	0.021	22810	0.008
1.4	10.0	0.021	23040	0.013	0.021	22530	0.007	0.021	20280	0.006
	15.0	0.015	22500	0.010	0.015	22000	0.006	0.015	19800	0.005
	6.0	0.036	23320	0.021	0.036	22810	0.011	0.036	20530	0.010
1.5	8.0	0.036	23320	0.018	0.036	22810	0.010	0.036	20530	0.009
	10.0	0.023	23000	0.015	0.023	22000	0.008	0.023	19800	0.007
	12.0	0.023	20730	0.019	0.023	20280	0.010	0.023	18250	0.009
1.6	14.0	0.023	20730	0.019	0.023	20280	0.010	0.023	18250	0.009
	16.0	0.014	20730	0.014	0.014	20280	0.007	0.014	18250	0.006
	6.0	0.076	23040	0.023	0.076	22530	0.012	0.076	20280	0.011
1.8	8.0	0.043	20730	0.022	0.043	20280	0.012	0.043	18250	0.011
	10.0	0.027	20730	0.022	0.027	20280	0.012	0.027	18250	0.011
	12.0	0.027	20730	0.019	0.027	20280	0.010	0.027	18250	0.009
2.0	6.0	0.090	20160	0.027	0.090	19710	0.014	0.090	17740	0.013
	8.0	0.054	22050	0.022	0.054	19400	0.013	0.054	17460	0.012
	10.0	0.040	18660	0.025	0.040	18250	0.014	0.040	16430	0.013
2.2	12.0	0.032	18140	0.022	0.032	17740	0.012	0.032	15970	0.011
	14.0	0.033	19350	0.020	0.033	18920	0.011	0.033	17030	0.010
	16.0	0.026	17000	0.017	0.026	16720	0.009	0.026	15050	0.008
2.4	6.0	0.099	20160	0.028	0.099	19710	0.014	0.099	17740	0.013
	8.0	0.072	18140	0.028	0.072	17740	0.015	0.072	15970	0.014
	10.0	0.054	18140	0.026	0.054	17740	0.014	0.054	15970	0.013
2.6	12.0	0.054	18140	0.022	0.054	17740	0.012	0.054	15970	0.011
	14.0	0.034	18140	0.021	0.034	17740	0.012	0.034	15970	0.011
	16.0	0.034	16130	0.019	0.034	15770	0.010	0.034	14190	0.009
2.8	18.0	0.034	16130	0.019	0.034	15770	0.010	0.034	14190	0.009
	20.0	0.034	16130	0.019	0.034	15770	0.010	0.034	14190	0.009

cont'd ▶

Recommended Cutting Data



Note: These recommended cutting data indicators are just for reference. They should be adjusted according to the different cutting condition



NiTiCo 30 Miniature Endmills with Long Neck, 2 Flutes - G87, H56

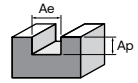

Slotting		M			S						
Working Material		Stainless steel			Titanium			Cobalt Alloy			
Properties		High Machinability			-			-			
D	Effective Length	Ap	N	Fz	Ap	N	Fz	Ap	N	Fz	
1.6	6.0	0.099	18720	0.030	0.099	18300	0.016	0.099	16470	0.014	
	8.0	0.099	18720	0.029	0.099	18300	0.015	0.099	16470	0.014	
	10.0	0.075	16320	0.030	0.075	15960	0.016	0.075	14370	0.015	
	12.0	0.060	16650	0.026	0.060	16280	0.013	0.060	14650	0.012	
	14.0	0.050	17280	0.024	0.050	16900	0.013	0.050	15210	0.012	
	16.0	0.045	15500	0.022	0.045	14960	0.011	0.045	13460	0.010	
	18.0	0.045	15500	0.022	0.045	14870	0.011	0.045	13380	0.010	
	20.0	0.040	15500	0.022	0.040	14830	0.011	0.040	13350	0.010	
1.8	6.0	0.117	18720	0.032	0.117	18300	0.016	0.117	16470	0.014	
	8.0	0.117	18720	0.029	0.117	18300	0.015	0.117	16470	0.014	
	10.0	0.118	16650	0.029	0.118	16280	0.016	0.118	14650	0.014	
	12.0	0.075	15800	0.027	0.075	15400	0.014	0.075	13860	0.013	
	14.0	0.040	15700	0.025	0.040	14960	0.014	0.040	13460	0.013	
	16.0	0.060	14200	0.026	0.060	14430	0.013	0.060	12990	0.012	
	18.0	0.050	14100	0.026	0.050	13990	0.013	0.050	12590	0.012	
	20.0	0.043	14000	0.026	0.043	13640	0.012	0.043	12280	0.011	
2.0	6.0	0.180	15120	0.039	0.180	14780	0.018	0.180	13310	0.017	
	8.0	0.126	15120	0.036	0.126	14780	0.019	0.126	13310	0.017	
	10.0	0.126	15120	0.035	0.126	14780	0.019	0.126	13310	0.017	
	12.0	0.090	13610	0.032	0.090	14170	0.016	0.090	12750	0.015	
	14.0	0.072	13610	0.032	0.072	14170	0.016	0.072	12750	0.015	
	16.0	0.072	13610	0.032	0.072	13310	0.017	0.072	11980	0.015	
	18.0	0.045	13610	0.032	0.045	13310	0.017	0.045	11980	0.015	
	20.0	0.045	13610	0.029	0.045	13310	0.016	0.045	11980	0.014	
	25.0	0.045	12100	0.025	0.045	11830	0.014	0.045	10640	0.012	
	30.0	0.027	12100	0.025	0.027	11830	0.014	0.027	10640	0.012	
2.5	8.0	0.162	12960	0.044	0.162	12670	0.026	0.162	11400	0.023	
	10.0	0.140	14580	0.040	0.140	14260	0.022	0.140	12830	0.020	
	12.0	0.162	12960	0.043	0.162	12670	0.024	0.162	11400	0.021	
	14.0	0.080	13320	0.033	0.080	13020	0.021	0.080	11720	0.019	
	16.0	0.090	11670	0.042	0.090	11400	0.023	0.090	10260	0.020	
	18.0	0.090	11670	0.039	0.090	11400	0.021	0.090	10260	0.019	
	20.0	0.090	11670	0.036	0.090	11400	0.020	0.090	10260	0.018	
	25.0	0.058	11000	0.035	0.058	10560	0.017	0.058	9500	0.015	
	30.0	0.054	10370	0.031	0.054	10140	0.017	0.054	9120	0.016	
	3.0	8.0	0.270	11520	0.052	0.270	11260	0.027	0.270	10140	0.024
10.0		0.150	14400	0.047	0.150	14080	0.026	0.150	12670	0.023	
12.0		0.189	11520	0.043	0.189	11260	0.024	0.189	10140	0.021	
14.0		0.095	10600	0.042	0.095	12320	0.019	0.095	11090	0.017	
16.0		0.135	10370	0.042	0.135	10140	0.023	0.135	9120	0.021	
18.0		0.120	10370	0.041	0.120	10140	0.022	0.120	9120	0.020	
20.0		0.108	10360	0.040	0.108	10140	0.022	0.108	9120	0.020	
25.0		0.072	10360	0.040	0.072	10140	0.022	0.072	9120	0.020	
4.0		10.0	0.155	14130	0.054	0.155	13820	0.033	0.155	12430	0.030
		15.0	0.155	12000	0.058	0.155	11440	0.036	0.155	10300	0.032
	20.0	0.252	7620	0.090	0.252	7440	0.055	0.252	6700	0.049	
	25.0	0.144	7620	0.081	0.144	7440	0.050	0.144	6700	0.045	
	30.0	0.144	7610	0.081	0.144	7440	0.049	0.144	6700	0.044	
	40.0	0.090	6850	0.081	0.090	6710	0.049	0.090	6040	0.044	

ALU LINE
 EZ LINE -
 ENDMILL
 SE 30
NITICO 30
 OPTIMUM
 SE 45
 SE 45X
 NITICO 45
 SE 60
 SE 60X
 DN70 -
 SE 70
 SE GR
 TE 45
 PLUNGE
 -MILL
 THREAD
 MILL

Recommended Cutting Data



Note: These recommended cutting data indicators are just for reference. They should be adjusted according to the different cutting condition



NiTiCo 30 Miniature Ballnose with Long Neck, 2 Flutes - G88

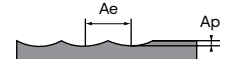

Profiling		K			P					
Working Material		Grey Cast Iron			Carbon Steel			Alloy steel		
Properties		-			520 < Rm < 1200					
D	Effective Length	Ap	N	Fz	Ap	N	Fz	Ap	N	Fz
0.2	1.0	0.013	47500	0.003		50000	0.004	0.014	46000	0.003
	2.0	0.008	47500	0.003	0.008	50000	0.003	0.008	46000	0.003
0.3	1.0	0.020	47500	0.005	0.021	50000	0.005	0.021	46000	0.005
	2.0	0.011	47500	0.004	0.012	50000	0.005	0.012	46000	0.004
	3.0	0.008	46170	0.004	0.008	48600	0.005	0.008	44710	0.004
0.4	1.0	0.038	47500	0.008	0.040	50000	0.008	0.040	46000	0.008
	2.0	0.027	47500	0.006	0.028	50000	0.006	0.028	46000	0.006
	3.0	0.015	47500	0.004	0.016	50000	0.005	0.016	46000	0.004
	4.0	0.010	44460	0.005	0.010	46800	0.005	0.010	43060	0.005
0.5	5.0	0.015	44460	0.005	0.016	46800	0.005	0.016	43060	0.004
	2.0	0.033	47500	0.011	0.035	50000	0.012	0.035	46000	0.011
	3.0	0.029	44460	0.009	0.030	46800	0.009	0.030	43060	0.008
	4.0	0.019	44460	0.007	0.020	46800	0.007	0.020	43060	0.006
	5.0	0.017	41040	0.007	0.018	43200	0.008	0.018	39740	0.007
0.6	6.0	0.017	36940	0.007	0.018	38880	0.007	0.018	35770	0.006
	8.0	0.008	36940	0.007	0.008	38880	0.007	0.008	35770	0.006
	2.0	0.060	47500	0.021	0.063	50000	0.023	0.063	46000	0.021
	3.0	0.039	44460	0.018	0.041	46800	0.019	0.041	43060	0.018
	4.0	0.025	41040	0.019	0.026	43200	0.020	0.026	39740	0.018
	5.0	0.019	41040	0.014	0.020	43200	0.015	0.020	39740	0.013
0.8	6.0	0.014	35570	0.011	0.015	37440	0.012	0.015	34440	0.011
	8.0	0.014	35570	0.010	0.015	37440	0.011	0.015	34440	0.010
	2.0	0.114	47500	0.026	0.120	50000	0.027	0.120	46000	0.025
	4.0	0.074	41040	0.030	0.078	43200	0.031	0.078	39740	0.029
	5.0	0.056	39520	0.028	0.059	41600	0.029	0.059	38270	0.027
	6.0	0.040	36940	0.024	0.042	38880	0.025	0.042	35770	0.023
	7.0	0.033	34580	0.020	0.035	36400	0.021	0.035	33490	0.019
1.0	8.0	0.019	32830	0.019	0.020	34560	0.020	0.020	31800	0.018
	10.0	0.019	31920	0.014	0.020	33600	0.015	0.020	30910	0.013
	3.0	0.190	41040	0.041	0.200	43200	0.043	0.200	39740	0.040
	4.0	0.133	40010	0.042	0.140	42120	0.045	0.140	38750	0.041
	5.0	0.086	36940	0.040	0.090	38880	0.042	0.090	35770	0.039
	6.0	0.057	32110	0.030	0.060	33800	0.032	0.060	31100	0.029
	7.0	0.057	30780	0.026	0.060	32400	0.027	0.060	29810	0.025
	8.0	0.057	30400	0.026	0.060	32000	0.027	0.060	29440	0.025
	9.0	0.043	30400	0.026	0.045	32000	0.027	0.045	29440	0.025
	10.0	0.036	30400	0.026	0.038	32000	0.027	0.038	29440	0.025
1.2	12.0	0.024	27360	0.020	0.025	28800	0.021	0.025	26500	0.020
	14.0	0.019	27360	0.020	0.020	28800	0.021	0.020	26500	0.020
	16.0	0.014	27360	0.020	0.015	28800	0.021	0.015	26500	0.020
	20.0	0.010	21550	0.018	0.010	22680	0.019	0.010	20870	0.018
	6.0	0.105	32830	0.036	0.110	34560	0.038	0.110	31800	0.035
1.4	8.0	0.057	30400	0.032	0.060	32000	0.033	0.060	29440	0.031
	10.0	0.050	31120	0.025	0.053	32760	0.026	0.053	30140	0.024
	12.0	0.043	29450	0.025	0.045	31000	0.026	0.045	28520	0.024
1.5	8.0	0.105	31120	0.034	0.110	32760	0.036	0.110	30140	0.033
	12.0	0.050	28730	0.026	0.053	30240	0.027	0.053	27820	0.025
	16.0	0.033	26680	0.019	0.035	28080	0.020	0.035	25830	0.019
1.5	8.0	0.086	30400	0.039	0.090	32000	0.041	0.090	29440	0.038
	12.0	0.086	28730	0.028	0.090	30240	0.030	0.090	27820	0.027
	18.0	0.036	26680	0.021	0.038	28080	0.022	0.038	25830	0.021
	18.0	0.036	21550	0.026	0.038	22680	0.028	0.038	20870	0.025

cont'd ▶

Recommended Cutting Data



Note: These recommended cutting data indicators are just for reference. They should be adjusted according to the different cutting condition



NiTiCo 30 Miniature Ballnose with Long Neck, 2 Flutes - G88

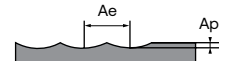

Profiling		K			P					
Working Material		Grey Cast Iron			Carbon Steel			Alloy steel		
Properties					-			520 < Rm < 1200		
D	Effective Length	Ap	N	Fz	Ap	N	Fz	Ap	N	Fz
1.6	8.0	0.209	30400	0.045	0.220	32000	0.048	0.220	29440	0.044
	12.0	0.093	31120	0.042	0.098	32760	0.044	0.098	30140	0.041
	16.0	0.057	23340	0.034	0.060	24570	0.036	0.060	22600	0.033
	20.0	0.038	20520	0.027	0.040	21600	0.029	0.040	19870	0.026
1.8	8.0	0.247	29930	0.049	0.260	31500	0.052	0.260	28980	0.047
	12.0	0.100	26680	0.034	0.105	28080	0.036	0.105	25830	0.033
	16.0	0.065	21280	0.043	0.068	22400	0.045	0.068	20610	0.042
	20.0	0.043	19760	0.032	0.045	20800	0.034	0.045	19140	0.031
2.0	4.0	0.380	29450	0.072	0.400	31000	0.076	0.400	28520	0.070
	6.0	0.380	29930	0.064	0.400	31500	0.068	0.400	28980	0.062
	8.0	0.266	29930	0.064	0.280	31500	0.068	0.280	28980	0.062
	10.0	0.200	27930	0.057	0.210	29400	0.060	0.210	27050	0.055
	12.0	0.114	25140	0.057	0.120	26460	0.060	0.120	24340	0.055
	14.0	0.114	25140	0.049	0.120	26460	0.052	0.120	24340	0.048
	16.0	0.114	21280	0.038	0.120	22400	0.039	0.120	20610	0.036
	18.0	0.086	21280	0.035	0.090	22400	0.036	0.090	20610	0.034
	20.0	0.071	19760	0.037	0.075	20800	0.039	0.075	19140	0.036
	22.0	0.048	16960	0.032	0.050	17850	0.034	0.050	16420	0.031
3.0	8.0	0.570	22800	0.107	0.600	24000	0.113	0.600	22080	0.104
	10.0	0.399	22800	0.107	0.420	24000	0.113	0.420	22080	0.104
	16.0	0.299	21280	0.077	0.315	22400	0.081	0.315	20610	0.075
	20.0	0.171	17780	0.064	0.180	18720	0.067	0.180	17220	0.062
	25.0	0.114	15960	0.071	0.120	16800	0.075	0.120	15460	0.069
	30.0	0.114	15960	0.066	0.120	16800	0.069	0.120	15460	0.064
	35.0	0.076	12160	0.061	0.080	12800	0.064	0.080	11780	0.059
4.0	10.0	0.570	16390	0.143	0.600	17250	0.150	0.600	15870	0.138
	16.0	0.399	16390	0.143	0.420	17250	0.150	0.420	15870	0.138
	20.0	0.399	14200	0.114	0.420	14950	0.120	0.420	13750	0.110
	25.0	0.228	12780	0.103	0.240	13460	0.108	0.240	12380	0.099
	30.0	0.152	11800	0.086	0.160	12420	0.090	0.160	11430	0.083
	35.0	0.095	11800	0.086	0.100	12420	0.090	0.100	11430	0.083
	40.0	0.095	11800	0.086	0.100	12420	0.090	0.100	11430	0.083
	50.0	0.095	8740	0.081	0.100	9200	0.085	0.100	8460	0.078

AU LINE
 EZ LINE -
 ENDMILL
 SE 30
NITICO 30
 OPTIMUM
 SE 45
 SE 45X
 NITICO 45
 SE 60
 SE 60X
 DN70 -
 SE 70
 SE GR
 TE 45
 PLUNGE
 -MILL
 THREAD
 MILL

Recommended Cutting Data



Note: These recommended cutting data indicators are just for reference. They should be adjusted according to the different cutting condition



NiTiCo 30 Miniature Ballnose with Long Neck, 2 Flutes - G88

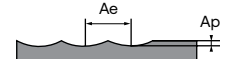

Profiling		M			S					
Working Material		Stainless steel			Titanium			Cobalt Alloy		
Properties		High Machinability			-			-		
D	Effective Length	Ap	N	Fz	Ap	N	Fz	Ap	N	Fz
0.2	1.0	0.013	50000	0.004		44000	0.002	0.013	39600	0.002
	2.0	0.007	50000	0.003	0.007	44000	0.002	0.007	39600	0.002
0.3	1.0	0.019	50000	0.005	0.019	44000	0.003	0.019	39600	0.002
	2.0	0.011	50000	0.004	0.011	44000	0.002	0.011	39600	0.002
	3.0	0.007	48600	0.004	0.007	42770	0.002	0.007	38490	0.002
0.4	1.0	0.036	50000	0.008	0.036	44000	0.005	0.036	39600	0.004
	2.0	0.025	50000	0.006	0.025	44000	0.003	0.025	39600	0.003
	3.0	0.014	46800	0.005	0.014	4180	0.003	0.014	37070	0.002
	4.0	0.009	45000	0.005	0.009	39600	0.003	0.009	35640	0.002
0.5	5.0	0.014	42120	0.005	0.014	37070	0.003	0.014	33360	0.002
	2.0	0.032	50000	0.011	0.032	44000	0.006	0.032	39600	0.006
	3.0	0.027	43200	0.009	0.027	38020	0.005	0.027	34210	0.004
	4.0	0.018	42120	0.007	0.018	37070	0.004	0.018	33360	0.003
	5.0	0.016	32400	0.009	0.016	28510	0.005	0.016	25660	0.004
0.6	6.0	0.012	34990	0.007	0.012	30790	0.004	0.012	27710	0.003
	8.0	0.007	34990	0.007	0.007	30790	0.004	0.007	27710	0.003
	2.0	0.057	48600	0.023	0.057	42770	0.013	0.057	38490	0.011
	3.0	0.037	43200	0.021	0.037	38020	0.011	0.037	34210	0.010
	4.0	0.023	42120	0.020	0.023	37070	0.011	0.023	33360	0.010
	5.0	0.018	38880	0.015	0.018	34210	0.008	0.018	30790	0.007
0.8	6.0	0.014	33700	0.013	0.014	29650	0.007	0.014	26690	0.007
	8.0	0.014	33700	0.011	0.014	29650	0.006	0.014	26690	0.005
	2.0	0.108	48600	0.028	0.108	42770	0.015	0.108	38490	0.014
	4.0	0.070	40820	0.033	0.070	35930	0.018	0.070	32330	0.016
	5.0	0.053	37440	0.032	0.053	32950	0.018	0.053	29650	0.016
	6.0	0.038	34990	0.027	0.038	30790	0.015	0.038	27710	0.013
1.0	7.0	0.250	32760	0.022	0.250	28830	0.012	0.250	25950	0.011
	8.0	0.018	31100	0.019	0.018	27370	0.011	0.018	24630	0.010
	10.0	0.018	31000	0.014	0.018	27280	0.008	0.018	24550	0.007
	3.0	0.180	32400	0.054	0.180	28510	0.030	0.180	25660	0.027
	4.0	0.126	32400	0.056	0.126	28510	0.031	0.126	25660	0.028
	5.0	0.081	34990	0.052	0.081	30790	0.029	0.081	27710	0.026
	6.0	0.054	31000	0.048	0.054	27280	0.026	0.054	24550	0.024
	7.0	0.054	30240	0.026	0.054	26610	0.014	0.054	23950	0.013
	8.0	0.054	30000	0.026	0.054	26400	0.014	0.054	23760	0.013
	9.0	0.041	30000	0.026	0.041	26400	0.014	0.041	23760	0.013
1.2	10.0	0.034	28800	0.027	0.034	25340	0.015	0.034	22810	0.014
	12.0	0.023	25920	0.021	0.023	22810	0.012	0.023	20530	0.011
	14.0	0.018	25920	0.021	0.018	22810	0.012	0.018	20530	0.011
	16.0	0.014	25920	0.021	0.014	22810	0.012	0.014	20530	0.011
	20.0	0.009	20410	0.019	0.009	17960	0.010	0.009	16170	0.009
	6.0	0.099	31100	0.040	0.099	27370	0.022	0.099	24630	0.020
	8.0	0.054	28350	0.037	0.054	24950	0.020	0.054	22450	0.018
	10.0	0.048	29480	0.025	0.048	25950	0.014	0.048	23350	0.012
1.4	12.0	0.041	28350	0.026	0.041	24950	0.014	0.041	22450	0.013
	8.0	0.099	29480	0.036	0.099	25950	0.020	0.099	23350	0.018
	12.0	0.048	27220	0.027	0.048	23950	0.015	0.048	21560	0.013
1.5	16.0	0.032	25270	0.020	0.032	22240	0.011	0.032	20020	0.010
	8.0	0.081	28800	0.036	0.081	25340	0.020	0.081	22810	0.018
	12.0	0.081	27220	0.030	0.081	23950	0.016	0.081	21560	0.015
	16.0	0.034	25270	0.022	0.0342	22240	0.012	0.0342	20020	0.011
	18.0	0.034	20410	0.028	0.034	17960	0.015	0.034	16170	0.014

cont'd ▶

Recommended Cutting Data



Note: These recommended cutting data indicators are just for reference. They should be adjusted according to the different cutting condition



NiTiCo 30 Miniature Ballnose with Long Neck, 2 Flutes - G88

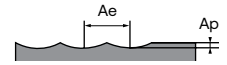

Profiling		M			S					
Working Material		Stainless steel			Titanium			Cobalt Alloy		
Properties		High Machinability			-			-		
D	Effective Length	Ap	N	Fz	Ap	N	Fz	Ap	N	Fz
1.6	8.0	0.198	28800	0.048	0.198	25340	0.026	0.198	22810	0.024
	12.0	0.088	29480	0.044	0.088	25950	0.024	0.088	23350	0.022
	16.0	0.054	22110	0.036	0.054	19460	0.020	0.054	17510	0.018
	20.0	0.036	19440	0.029	0.036	17110	0.016	0.036	15400	0.014
1.8	8.0	0.234	28800	0.051	0.234	25340	0.028	0.234	22810	0.025
	12.0	0.095	25270	0.036	0.095	22240	0.020	0.095	20020	0.018
	16.0	0.061	20160	0.045	0.061	17740	0.025	0.061	15970	0.022
	20.0	0.041	18720	0.034	0.041	16470	0.019	0.041	14830	0.017
2.0	4.0	0.360	28350	0.075	0.360	24950	0.041	0.360	22450	0.037
	6.0	0.360	28350	0.067	0.360	24950	0.037	0.360	22450	0.033
	8.0	0.252	28350	0.067	0.252	24950	0.037	0.252	22450	0.033
	10.0	0.189	26460	0.060	0.189	23280	0.033	0.189	20960	0.030
	12.0	0.108	23810	0.060	0.108	20960	0.033	0.108	18860	0.030
	14.0	0.108	23810	0.052	0.108	20960	0.029	0.108	18860	0.026
	16.0	0.108	20160	0.040	0.108	17740	0.022	0.108	15970	0.020
	18.0	0.081	20110	0.037	0.081	17690	0.020	0.081	15920	0.018
	20.0	0.068	18720	0.039	0.068	16470	0.022	0.068	14830	0.019
	22.0	0.045	16070	0.034	0.045	14140	0.019	0.045	12720	0.017
3.0	8.0	0.540	21600	0.113	0.540	19010	0.062	0.540	17110	0.056
	10.0	0.378	21600	0.113	0.378	19010	0.062	0.378	17110	0.056
	16.0	0.284	20160	0.081	0.284	17740	0.045	0.284	15970	0.040
	20.0	0.162	16850	0.068	0.162	14830	0.037	0.162	13340	0.033
	25.0	0.108	15120	0.075	0.108	13310	0.041	0.108	11980	0.037
	30.0	0.108	15120	0.069	0.108	13310	0.038	0.108	11980	0.034
	35.0	0.072	11520	0.064	0.072	10140	0.035	0.072	9120	0.032
4.0	10.0	0.540	15530	0.150	0.540	13660	0.083	0.540	12300	0.074
	16.0	0.378	15530	0.150	0.378	13660	0.083	0.378	12300	0.074
	20.0	0.378	13460	0.120	0.378	11840	0.066	0.378	10660	0.059
	25.0	0.216	12110	0.108	0.216	10660	0.059	0.216	9590	0.053
	30.0	0.144	11180	0.090	0.144	9840	0.049	0.144	8850	0.045
	35.0	0.090	11180	0.090	0.090	9840	0.049	0.090	8850	0.045
	40.0	0.090	11180	0.090	0.090	9840	0.049	0.090	8850	0.045
	50.0	0.090	8280	0.085	0.090	7290	0.047	0.090	6560	0.042

AU LINE
 EZ LINE -
 ENDMILL
 SE 30
NITICO 30
 OPTIMUM
 SE 45
 SE 45X
 NITICO 45
 SE 60
 SE 60X
 DN70 -
 SE 70
 SE GR
 TE 45
 PLUNGE
 -MILL
 THREAD
 MILL



ENDMILLS







OPTIMUM

The most versatile program for multiple materials and applications
For material application ≤ 45 HRC

Index - Optimum, For ≤ 45 HRC

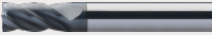
Suitable for Material Groups
 Adapté pour les matériaux
 适用于材料
 Geeignet für die Materialgruppen
 Adatto per il materiale

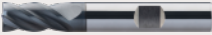

	EDP Number	Type	No. Z	Helix Angle	Coating	Performance	Page Number
	918	 OPTIMUM DP	4	40°	G6110	G	165
NEW	981	 OPTIMUM DP, Recess	4	40°	G6110	G	165
	K38	 OPTIMUM R-LIKE DP	4	40°	G6110	G	166
	K52	 OPTIMUM R-LIKE DP, Recess	4	40°	G6110	G	166
	K47	 OPTIMUM R-LIKE DP, Weldon	4	40°	G6110	G	166
	K53	 OPTIMUM R-LIKE DP, Weldon, Recess	4	40°	G6110	G	166
NEW	919	 OPTIMUM DP Torus	4	40°	G6110	G	169
NEW	991	 OPTIMUM DP Torus, Recess	4	40°	G6110	G	169

G - General P - Performance

FEATURES & BENEFITS

Optimum

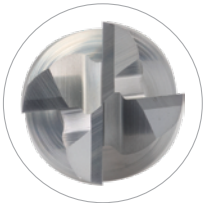

Top View

1 Differential Pitch (DP)



Provides excellent surface finishing while eliminating chatter

2 Superior Coating

Reduce tool wear to achieve cost-effective machining

3 Ideal Cutting Edge

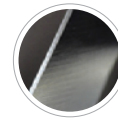

Provide edge protection to prolong tool life

4 Suitable for Material Groups





1. Ungleiche Teilung (DP)
Per una lavorazione senza vibrazione e finiture superficiali eccellenti
2. Ausgezeichnete Beschichtung
Reduziert den Werkzeugverschleiß und das bedeutet eine kostengünstige Bearbeitung
3. Perfekte Schneide
Bietet Schneidkantenschutz, um die Lebensdauer des Werkzeugs zu verlängern
4. Geeignet für Materialgruppen P, M, K, N, S



1. 不等分割設計 (DP)
有效降低加工時的振動從而，達到更好的工件表面光潔度。
2. 優質塗層
減少刀具磨損，實現經濟高效的加工。
3. 理想的切削刃
提供邊緣保護延長刀具壽命。
4. 適用於材料 P、M、K、N、S



1. Design del passo differenziale (DP)
Design del passo differenziale (DP) Riduce le vibrazioni, massimizza la produttività e la durata dell'utensile.
2. Rivestimento superiore
Riduce l'usura dello strumento per raggiungere una lavorazione efficace in termini di costi
3. Angolo di taglio ideale
Offre una protezione degli angoli per prolungare la durata dello strumento
4. Adatto per Materiale P, M, K, N, S



1. Conception à pas différentiel (DP)
Pour un usinage sans vibrations et un très bon état de surface
2. Revêtement supérieur
Réduit l'usure de l'outil pour parvenir à un usinage économique
3. Arête tranchante idéale
Protège les arêtes pour prolonger la durée de vie de l'outil
4. Adapté aux matériaux P, M, K, N, S

OPTIMUM DP ENDMILLS / WITH RECESS, 4 FLUTES

- VHM Optimum DP Fräser, 4 Zähne
- Frese Optimum, con passo differenziale, 4 taglienti
- Fraises Optimum DP à pas décalés, 4 dents
- 整体硬质合金 Optimum DP 系列 4刃平底铣刀

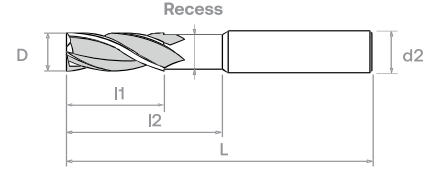
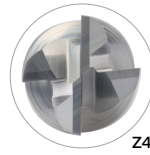
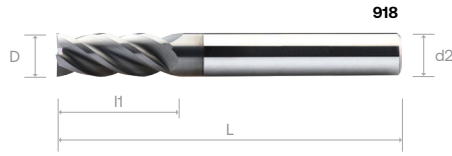
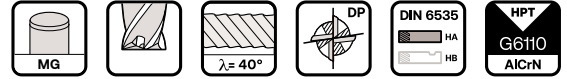

Order Number	Dimension (mm)					G6110	Order Number <small>DIN 6535</small>	Dimension (mm)					G6110	
	D	I1	I2	L	d2 (h6)			D	I1	I2	L	d2 (h6)		
918 0100 050 03	1	3		50	3	•	981 0100 050 03	1	3		50	3		
918 0100 050 04				50	4	•	981 0100 050 04				50	4		
918 0150 050 03	1.5	4.5		50	3	•	981 0150 050 03	1.5	4.5		50	3		
918 0150 050 04				50	4	•	981 0150 050 04				50	4		
918 0200 050 03	2			50	3	•	981 0200 050 03	2			50	3		
918 0200 050 04				50	4	•	981 0200 050 04				50	4		
918 0250 050 03	2.5	6.5		50	3	•	981 0250 050 03	2.5	6.5		50	3		
918 0250 050 04				50	4	•	981 0250 050 04				50	4		
918 0300 050 03	3			50	3	•	981 0300 050 03	3			14	50	3	◦
918 0300 050 04				50	4	•	981 0300 050 04				14	50	4	◦
918 0300 050 06	4	12		50	6	•	981 0300 050 06	4	12		14	50	6	•
918 0400				50	4	•	981 0400 *				20	50	4	•
918 0400 050 06	5	15		50	6	•	981 0400 050 06	5	15		50	6		
918 0500				50	5	•	981 0500 *				22	50	5	•
918 0500 050 06 15	6	16		50	6	•	981 0500 050 06 15	6	16		50	6		
918 0600 050 16				50	6	•	981 0600 050 16				50	6		
918 0600 060	8	22		60	6	•	981 0600 060 *	8	22	24	60	6	•	
918 0800 22				64	8	•	981 0800 22 *				64	8	•	
918 1000 070 27	10	27		70	10	•	981 1000 070 27	10	27		70	10		
918 1000 075				75	10	•	981 1000 075				75	10	•	
918 1200 075 32	12	32		75	12	•	981 1200 075 32	12	32		75	12		
918 1200 075 24				75	12	◦	981 1200 075 24 *				75	12	•	
918 1400	14	32		90	14	•	981 1400	14	32		42	90	14	◦
918 1600				90	16	•	981 1600 *				42	90	16	•
918 1800	18	38		100	18	•	981 1800 *	18	38		50	100	18	◦
918 2000				100	20	•	981 2000 *				50	100	20	•

* - DIN 6535

Ø mm	Tol. µm
3.0 - 6.0	-0 / -20
6.0 - 30.0	-0 / -25

Material Group | Material-Gruppe | Groupe Matière | Gruppo Materiali | 材质主类

Cutting Parameter

N01	N02	N03	K01	K02	P01	P02	P03	M01	M02	S01	S02	S03	H01	H02	O01	O02	170 - 174
-----	-----	-----	-----	-----	-----	-----	-----	-----	-----	-----	-----	-----	-----	-----	-----	-----	-----------

K38 / K52 / K47 / K53



OPTIMUM DP R-LIKE ENDMILLS / WITH RECESS, 4 FLUTES

- VHM Optimum DP R-Like Fräser, 4 Zähne
- Frese Optimum, con passo differenziale, raggio di protezione, 4 taglienti
- Fraises Optimum DP R-Like à pas décalés, 4 dents
- 整体硬质合金 Optimum DP 系列 微小R角4刃平底铣刀

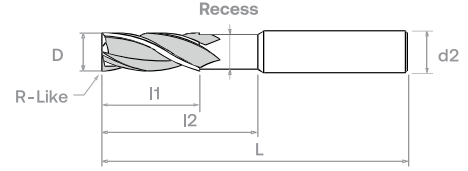
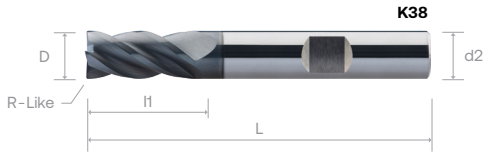
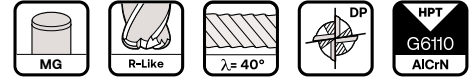

Order Number	Dimension (mm)						HA
	D	I1	I2	L	d2 (h6)	R-Like	
K47 0100 050 03	1	3		50	3	0.02	°
K47 0150 050 03	1.5	4.5		50	3	0.05	°
K47 0200 050 03	2	6.5		50	3	0.05	°
K47 0250 050 03	2.5			50	3	0.05	°
K47 0300 050 03	3	9		50	3	0.1	°
K47 0300 050 06				50	6	0.1	°
K47 0400	4	12		50	4	0.1	°
K47 0400 057 06 11		11		57	6	0.1	°
K47 0500	5	15		50	5	0.1	°
K47 0500 057 06 13		13		57	6	0.1	°
K47 0600 057 13	6	20		57	6	0.1	°
K47 0600 060				60	6	0.1	•
K47 0800	8		64	8	0.2	°	
K47 1000 072	10	22		72	10	0.2	°
K47 1000 070 27		27		70	10	0.2	•
K47 1200 083 26	12	26		83	12	0.2	°
K47 1400 083 26	14			83	14	0.2	°
K47 1600 092	16	32		92	16	0.2	°
K47 1800 092 32	18			92	18	0.2	°
K47 2000 104	20	38		104	20	0.2	°

Order Number	Dimension (mm)						HA
	D	I1	I2	L	d2 (h6)	R-Like	
K52 0100 050 03	1	3		50	3	0.02	°
K52 0150 050 03	1.5	4.5		50	3	0.05	°
K52 0200 050 03	2	6.5		50	3	0.05	°
K52 0250 050 03	2.5			50	3	0.05	°
K52 0300 050 03	3	9	15	50	3	0.1	°
K52 0300 050 06			15	50	6	0.1	°
K52 0400	4	12	20	50	4	0.1	°
K52 0400 057 06 11		11	20	57	6	0.1	°
K52 0500	5	15	20	50	5	0.1	°
K52 0500 057 06 13		13	20	57	6	0.1	°
K52 0600 057 13	6	20		57	6	0.1	°
K52 0600 060				25	60	6	0.1
K52 0800	8	20	26	64	8	0.2	°
K52 1000 072	10	22	32	72	10	0.2	°
K52 1000 070 27		27	32	70	10	0.2	°
K52 1200 083 26	12	26		83	12	0.2	°
K52 1400 083 26	14			83	14	0.2	°
K52 1600 092	16	32		92	16	0.2	°
K52 1800 092 32	18			92	18	0.2	°
K52 2000 104	20	38	50	104	20	0.2	°

Order Number	Dimension (mm)						HB
	D	I1	I2	L	d2 (h6)	R-Like	
K38 0100 050 03	1	3		50	3	0.02	
K38 0150 050 03	1.5	4.5		50	3	0.05	
K38 0200 050 03	2	6.5		50	3	0.05	
K38 0250 050 03	2.5			50	3	0.05	
K38 0300 050 03	3	9		50	3	0.1	°
K38 0300 050 06				50	6	0.1	°
K38 0400	4	12		50	4	0.1	
K38 0400 057 06 11		11		57	6	0.1	•
K38 0500	5	15		50	5	0.1	
K38 0500 057 06 13		13		57	6	0.1	•
K38 0600 057 13	6	20		57	6	0.1	•
K38 0600 060				60	6	0.1	•
K38 0800	8		64	8	0.2	•	
K38 1000 072	10	22		72	10	0.2	•
K38 1000 070 27		27		70	10	0.2	•
K38 1200 083 26	12	26		83	12	0.2	•
K38 1400 083 26	14			83	14	0.2	•
K38 1600 092	16	32		92	16	0.2	•
K38 1800 092 32	18			92	18	0.2	•
K38 2000 104	20	38		104	20	0.2	°

Order Number	Dimension (mm)						HB
	D	I1	I2	L	d2 (h6)	R-Like	
K53 0100 050 03	1	3		50	3	0.02	
K53 0150 050 03	1.5	4.5		50	3	0.05	
K53 0200 050 03	2	6.5		50	3	0.05	
K53 0250 050 03	2.5			50	3	0.05	
K53 0300 050 03	3	9	15	50	3	0.1	°
K53 0300 050 06			15	50	6	0.1	°
K53 0400	4	12	20	50	4	0.1	
K53 0400 057 06 11		11	20	57	6	0.1	•
K53 0500	5	15	20	50	5	0.1	
K53 0500 057 06 13		13	20	57	6	0.1	•
K53 0600 057 13	6	20		57	6	0.1	°
K53 0600 060				25	60	6	0.1
K53 0800	8	20	26	64	8	0.2	•
K53 1000 072	10	22	32	72	10	0.2	•
K53 1000 070 27		27	32	70	10	0.2	•
K53 1200 083 26	12	26		83	12	0.2	•
K53 1400 083 26	14			83	14	0.2	°
K53 1600 092	16	32		92	16	0.2	•
K53 1800 092 32	18			92	18	0.2	°
K53 2000 104	20	38	50	104	20	0.2	•



R - Like is an enhanced edge protection.

Material Group | Material-Gruppe | Groupe Matière | Gruppo Materiali | 材质主类

Cutting Parameter

N01	N02	N03	K01	K02	P01	P02	P03	M01	M02	S01	S02	S03	H01	H02	O01	O02
-----	-----	-----	-----	-----	-----	-----	-----	-----	-----	-----	-----	-----	-----	-----	-----	-----

170 - 174

ALU LINE
EZ LINE -
ENDMILL
SE 30
NITCO 30
OPTIMUM
SE 45
SE 45X
NITCO 45
SE 60
SE 60X
DN70 -
SE 70
SE GR
TE 45
PLUNGE
-MILL
THREAD
MILL

FEATURES & BENEFITS

Optimum Torus



Top View

1 Differential Pitch (DP)



Provides excellent surface finishing while eliminating chatter

2 Improved Corner Radius Design

Enhance durability on the radius area

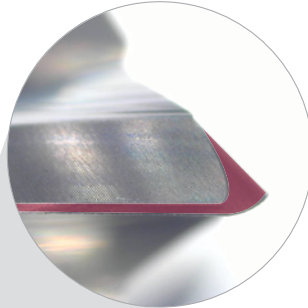

3 Cutting Edge Preparation

- Enhances tool life
- Less material adhere on the cutting edge for stable machining
- Improves wear resistance and reduces excessive friction

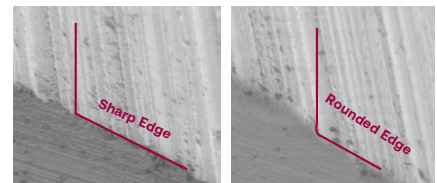

Before

After

4 Suitable for Material Groups





1. Ungleiche Teilung (DP)
Per una lavorazione senza vibrazione e finiture superficiali eccellenti
2. Verbessertes Eckradius-Design
Verbessern Sie die Haltbarkeit im Radiusbereich
3. Schneidkantenbehandlung
Verbessert die Werkzeuglebensdauer
Weniger Materialanhaftungen an der Schneide Für stabile Bearbeitung
4. Geeignet für Materialgruppen P, M, K, N, S



1. 不等分割設計 (DP)
有效降低加工時的振動從而, 達到更好的工件表面光潔度。
2. 改进的拐角半径设计
增强半径区域的耐用性。
3. 切削刃设置提高刀具寿命
提高刀具寿命。
切削刃上的材料附着少, 加工稳定。
提高耐磨性并减少过度摩擦。
4. 适用于材料 P、M、K、N、S



1. Design del passo differenziale (DP)
Design del passo differenziale (DP) Riduce le vibrazioni, massimizza la produttività e la durata dell'utensile.
2. Design del raggio d'angolo migliorato
Migliora la durata nell'area del raggio
3. Preparazione dell'angolo di taglio
Migliora la durata dello strumento
Meno materiale che aderisce sull'angolo di taglio per una lavorazione stabile
Migliora la resistenza all'usura e riduce l'attrito eccessivo
4. Adatto per Materiale P, M, K, N, S



1. Conception à pas différentiel (DP)
Pour un usinage sans vibrations et un très bon état de surface
2. Conception améliorée du rayon d'angle
Améliorer la durabilité sur la zone du rayon
3. Préparation des arêtes de coupes
Améliore la durée de vie de l'outil
Moins de matériau adhère à l'arête tranchante pour un usinage stable
Améliore la résistance à l'usure et réduit les frottements excessifs
4. Adapté aux matériaux P, M, K, N, S

OPTIMUM DP TORUS ENDMILLS / WITH RECESS, 4 FLUTES

- VHM Optimum Torusfräser , 4 Zähne
- Frese toriche Optimum, con passo differenziale, 4 taglienti
- Fraises Optimum toriques à pas décalés, 4 dents
- 整体硬质合金 Optimum DP 系列 4刃圆鼻铣刀

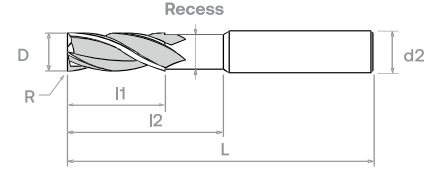
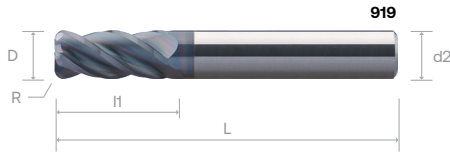
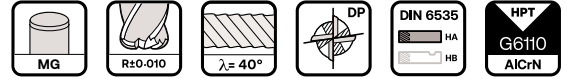

Order Number	Dimension (mm)						G6110	Order Number DIN 6535	Dimension (mm)						G6110
	D	I1	I2	L	d2 (h6)	R			D	I1	I2	L	d2 (h6)	R	
919 0100 050 0300 010	1	3		50	3	0.1	°	991 0100 050 0300 010	1	3		50	3	0.1	°
919 0150 050 0300 020	1.5	4.5		50	3	0.2	°	991 0150 050 0300 020	1.5	4.5		50	3	0.2	°
919 0200 050 0300 020	2			50	3	0.2	°	991 0200 050 0300 020	2			50	3	0.2	°
919 0250 050 0300 030	2.5	6.5		50	3	0.3	°	991 0250 050 0300 030	2.5	6.5		50	3	0.3	°
919 0300 050 0300 030				50	3	0.3	°	991 0300 050 0300 030 *			15	50	3	0.3	°
919 0300 050 0300 050				50	3	0.5	•	991 0300 050 0300 050 *			15	50	3	0.5	°
919 0300 057 0600 030	3	9		57	6	0.3	•	991 0300 057 0600 030	3	9	15	57	6	0.3	°
919 0300 057 0600 050				57	6	0.5	•	991 0300 057 0600 050			15	57	6	0.5	°
919 0400 050 0400 030				50	4	0.3	•	991 0400 050 0400 030 *			20	50	4	0.3	°
919 0400 050 0400 050				50	4	0.5	•	991 0400 050 0400 050 *			20	50	4	0.5	•
919 0400 057 0600 030	4	12		57	6	0.3	°	991 0400 057 0600 030	4	12	20	57	6	0.3	°
919 0400 057 0600 050				57	6	0.5	°	991 0400 057 0600 050			20	57	6	0.5	°
919 0500 050 0500 030				50	5	0.3	°	991 0500 050 0500 030 *			22	50	5	0.3	°
919 0500 050 0500 050				50	5	0.5	°	991 0500 050 0500 050 *			22	50	5	0.5	°
919 0500 057 0600 030	5	15		57	6	0.3	°	991 0500 057 0600 030	5	15	22	57	6	0.3	°
919 0500 057 0600 050				57	6	0.5	•	991 0500 057 0600 050			22	57	6	0.5	°
919 0600 057 0600 030				57	6	0.3	•	991 0600 057 0600 030			22	57	6	0.3	°
919 0600 057 0600 050	6	16		57	6	0.5	•	991 0600 057 0600 050	6	16	22	57	6	0.5	•
919 0600 057 0600 100				57	6	1	•	991 0600 057 0600 100			22	57	6	1	°
919 0800 064 0800 030				64	8	0.3	•	991 0800 064 0800 030 *			26	64	8	0.3	°
919 0800 064 0800 050				64	8	0.5	•	991 0800 064 0800 050 *			26	64	8	0.5	•
919 0800 064 0800 100	8	20		64	8	1	•	991 0800 064 0800 100 *	8	20	26	64	8	1	°
919 0800 064 0800 200				64	8	2	•	991 0800 064 0800 200 *			26	64	8	2	°
919 1000 070 1000 050				70	10	0.5	•	991 1000 070 1000 050 *			30	70	10	0.5	°
919 1000 070 1000 100				70	10	1	•	991 1000 070 1000 100 *			30	70	10	1	°
919 1000 070 1000 200	10	22		70	10	2	•	991 1000 070 1000 200 *	10	22	30	70	10	2	°
919 1200 083 1200 050				83	12	0.5	•	991 1200 083 1200 050			35	83	12	0.5	°
919 1200 083 1200 100				83	12	1	•	991 1200 083 1200 100			35	83	12	1	°
919 1200 083 1200 200	12	25		83	12	2	•	991 1200 083 1200 200	12	25	35	83	12	2	°
919 1600 090 1600 050				90	16	0.5	°	991 1600 090 1600 050 *			42	90	16	0.5	°
919 1600 090 1600 100				90	16	1	°	991 1600 090 1600 100 *			42	90	16	1	°
919 1600 090 1600 200				90	16	2	°	991 1600 090 1600 200 *			42	90	16	2	°
919 1600 090 1600 300				90	16	3	°	991 1600 090 1600 300 *			42	90	16	3	°
919 2000 100 2000 050				100	20	0.5	°	991 2000 100 2000 050 *			50	100	20	0.5	°
919 2000 100 2000 100				100	20	1	°	991 2000 100 2000 100 *			50	100	20	1	°
919 2000 100 2000 200	20	38		100	20	2	°	991 2000 100 2000 200 *	20	38	50	100	20	2	°
919 2000 100 2000 300				100	20	3	°	991 2000 100 2000 300 *			50	100	20	3	°

* - DIN 6535

Material Group | Material-Gruppe | Groupe Matière | Gruppo Materiali | 材质主类

Cutting Parameter

N01	N02	N03	K01	K02	P01	P02	P03	M01	M02	S01	S02	S03	H01	H02	O01	O02	170 - 174
○	○	○	○	○	○	○	○	○	○	○	○	○	○	○	○	○	

Recommended Cutting Data



Note: These recommended cutting data indicators are just for reference. They should be adjusted according to the different cutting condition



Optimum Endmills, 4 Flutes - 918, 981, 919, 991, K38, K47, K52, K53

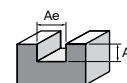

Slotting	N						K				S	
Working Material	Wrought Aluminium		Cast Aluminium		Copper alloy		Grey Cast Iron		Ductile Cast Iron		Titanium alloy	
Properties	Si < 9%		Si ≥ 9%		-		-		-		-	
Cutting depth, ap	1.00 × D		1.00 × D		1.00 × D		1.00 × D		0.80 × D		0.40 × D	
Cutting Width, ae	1.00 × D		1.00 × D				1.00 × D		1.00 × D		1.00 × D	
D	Vc	Fz	Vc	Fz	Vc	Fz	Vc	Fz	Vc	Fz	Vc	Fz
1		0.005		0.004		0.004		0.003		0.003		0.004
2		0.007		0.006		0.006		0.006		0.006		0.009
3		0.011		0.010		0.010		0.009		0.009		0.014
4		0.016		0.015		0.015		0.012		0.013		0.019
5		0.021		0.020		0.020		0.016		0.017		0.024
6		0.026		0.026		0.026		0.019		0.021		0.030
8	330	0.037	300	0.036	280	0.038	170	0.026	110	0.028	60	0.040
10		0.048		0.047		0.050		0.033		0.035		0.051
12		0.060		0.061		0.062		0.041		0.043		0.063
14		0.068		0.070		0.071		0.047		0.049		0.072
16		0.075		0.078		0.080		0.054		0.055		0.080
18		0.083		0.080		0.088		0.060		0.061		0.088
20		0.090		0.086		0.096		0.066		0.067		0.096

Optimum Endmills, 4 Flutes - 918, 981, 919, 991, K38, K47, K52, K53

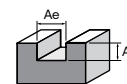

Slotting	P						M				S	
Working Material	Carbon steel		Alloy steel		Prehardened steel		Stainless steel		Stainless steel		Nickel Alloy	
Properties	-		520 < Rm < 1200		35 ≤ HRC < 45		High Machinability		Low Machinability		-	
Cutting depth, ap	1.00 × D		1.00 × D		0.80 × D		0.80 × D		0.40 × D		0.30 × D	
Cutting Width, ae	1.00 × D		1.00 × D		1.00 × D		1.00 × D		1.00 × D		1.00 × D	
D	Vc	Fz	Vc	Fz	Vc	Fz	Vc	Fz	Vc	Fz	Vc	Fz
1		0.003		0.003		0.003		0.003		0.003		0.004
2		0.006		0.006		0.006		0.006		0.007		0.009
3		0.009		0.009		0.009		0.010		0.011		0.014
4		0.012		0.012		0.012		0.014		0.016		0.019
5		0.016		0.016		0.016		0.018		0.020		0.024
6		0.019		0.019		0.019		0.022		0.025		0.030
8	200	0.026	160	0.026	150	0.026	120	0.030	80	0.034	30	0.040
10		0.033		0.034		0.033		0.038		0.044		0.051
12		0.041		0.041		0.041		0.047		0.054		0.063
14		0.047		0.047		0.047		0.054		0.062		0.072
16		0.054		0.053		0.054		0.061		0.069		0.080
18		0.060		0.058		0.060		0.067		0.076		0.088
20		0.066		0.064		0.066		0.073		0.082		0.096

AU LINE
 EZ LINE -
 ENDMILL
 SE 30
 NITCO 30
 OPTIMUM
 SE 45
 SE 45X
 NITCO 45
 SE 60
 SE 60X
 DN70 -
 SE 70
 SE GR
 TE 45
 PLUNGE
 -MILL
 THREAD
 MILL

Recommended Cutting Data



Note: These recommended cutting data indicators are just for reference. They should be adjusted according to the different cutting condition



Optimum Endmills, 4 Flutes - 918, 981, 919, 991, K38, K47, K52, K53

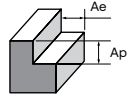

Side Milling	N						K				S	
Working Material	Wrought Aluminium		Cast Aluminium		Copper alloy		Grey Cast Iron		Ductile Cast Iron		Titanium alloy	
Properties	Si < 9%		Si ≥ 9%		-		-		-		-	
Cutting depth, ap	1.00 × D		1.00 × D		1.00 × D		1.00 × D		1.00 × D		1.00 × D	
Cutting Width, ae	0.30 × D		0.30 × D		0.30 × D		0.25 × D		0.18 × D		0.15 × D	
D	Vc	Fz	Vc	Fz	Vc	Fz	Vc	Fz	Vc	Fz	Vc	Fz
1		0.006		0.005		0.004		0.007		0.004		0.005
2		0.009		0.008		0.009		0.010		0.009		0.011
3		0.014		0.014		0.014		0.016		0.014		0.018
4		0.020		0.019		0.021		0.022		0.019		0.024
5		0.027		0.026		0.027		0.029		0.025		0.031
6		0.034		0.034		0.035		0.036		0.030		0.039
8	400	0.046	380	0.046	360	0.050	250	0.049	140	0.041	70	0.053
10		0.060		0.059		0.062		0.063		0.052		0.066
12		0.076		0.074		0.076		0.075		0.069		0.080
14		0.087		0.085		0.086		0.085		0.075		0.090
16		0.097		0.095		0.091		0.095		0.082		0.101
18		0.106		0.102		0.099		0.103		0.089		0.111
20		0.115		0.110		0.106		0.112		0.094		0.122

Optimum Endmills, 4 Flutes - 918, 981, 919, 991, K38, K47, K52, K53

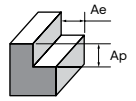

Side Milling	P						M				S	
Working Material	Carbon steel		Alloy steel		Prehardened steel		Stainless steel		Stainless steel		Nickel Alloy	
Properties	-		520 < Rm < 1200		35 ≤ HRC < 45		High Machinability		Low Machinability		-	
Cutting depth, ap	1.00 × D		1.00 × D		1.00 × D		1.00 × D		1.00 × D		1.00 × D	
Cutting Width, ae	0.25 × D		0.20 × D		0.18 × D		0.18 × D		0.15 × D		0.10 × D	
D	Vc	Fz	Vc	Fz	Vc	Fz	Vc	Fz	Vc	Fz	Vc	Fz
1		0.005		0.006		0.005		0.004		0.005		0.004
2		0.009		0.009		0.009		0.009		0.011		0.008
3		0.017		0.014		0.014		0.014		0.017		0.013
4		0.023		0.020		0.019		0.020		0.024		0.018
5		0.030		0.025		0.024		0.025		0.030		0.025
6		0.036		0.031		0.031		0.031		0.037		0.033
8	280	0.049	230	0.043	190	0.042	160	0.043	100	0.049	40	0.046
10		0.062		0.056		0.056		0.056		0.062		0.061
12		0.075		0.070		0.070		0.070		0.076		0.075
14		0.086		0.079		0.080		0.078		0.085		0.081
16		0.094		0.087		0.090		0.086		0.093		0.089
18		0.103		0.092		0.098		0.092		0.102		0.094
20		0.113		0.098		0.104		0.099		0.107		0.102

ALU LINE
EZ LINE - ENDMILL
SE 30
NITCo 30
OPTIMUM
SE 45
SE 45X
NITCo 45
SE 60
SE 60X
DM70 - SE70
SE GR
TE 45
PLUNGE -MILL
THREAD MILL

Recommended Cutting Data



Note: These recommended cutting data indicators are just for reference. They should be adjusted according to the different cutting condition



Optimum Endmills, 4 Flutes - 918, 981, 919, 991, K38, K47, K52, K53

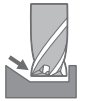

Ramp/Helical	N						K				S	
Working Material	Wrought Aluminium		Cast Aluminium		Copper alloy		Grey Cast Iron		Ductile Cast Iron		Titanium alloy	
Properties	Si < 9%		Si ≥ 9%		-		-		-		-	
Cutting depth, ap	1.00 × D		1.00 × D		1.00 × D		1.00 × D		1.00 × D		1.00 × D	
Ramping Angle	10°		10°		8°		5°		3°		2°	
D	Vc	Fz	Vc	Fz	Vc	Fz	Vc	Fz	Vc	Fz	Vc	Fz
1		0.004		0.003		0.003		0.002		0.002		0.003
2		0.005		0.005		0.005		0.005		0.005		0.007
3		0.010		0.008		0.008		0.007		0.007		0.011
4		0.013		0.012		0.012		0.010		0.010		0.015
5		0.017		0.016		0.016		0.013		0.014		0.019
6		0.021		0.021		0.021		0.015		0.017		0.024
8	250	0.030	220	0.029	210	0.030	130	0.021	80	0.022	45	0.032
10		0.038		0.038		0.040		0.026		0.028		0.041
12		0.048		0.049		0.050		0.033		0.034		0.050
14		0.054		0.056		0.057		0.038		0.039		0.058
16		0.060		0.062		0.064		0.043		0.044		0.064
18		0.066		0.064		0.070		0.048		0.049		0.070
20		0.072		0.069		0.077		0.053		0.054		0.077

Optimum Endmills, 4 Flutes - 918, 981, 919, 991, K38, K47, K52, K53



Ramp/Helical	P						M				S	
Working Material	Carbon steel		Alloy steel		Prehardened steel		Stainless steel		Stainless steel		Nickel Alloy	
Properties	-		520 < Rm < 1200		35 ≤ HRC < 45		High Machinability		Low Machinability		-	
Cutting depth, ap	1.00 × D		1.00 × D		1.00 × D		1.00 × D		1.00 × D		1.00 × D	
Ramping Angle	5°		5°		3°		3°		2°		1°	
D	Vc	Fz	Vc	Fz	Vc	Fz	Vc	Fz	Vc	Fz	Vc	Fz
1		0.002		0.002		0.002		0.002		0.002		0.003
2		0.005		0.005		0.005		0.005		0.006		0.007
3		0.007		0.007		0.007		0.008		0.009		0.011
4		0.010		0.010		0.010		0.011		0.013		0.015
5		0.013		0.013		0.013		0.014		0.016		0.019
6		0.015		0.015		0.015		0.018		0.020		0.024
8	150	0.021	120	0.021	110	0.021	90	0.024	60	0.027	20	0.032
10		0.026		0.027		0.026		0.030		0.035		0.041
12		0.033		0.033		0.033		0.038		0.043		0.050
14		0.038		0.038		0.038		0.043		0.050		0.058
16		0.043		0.042		0.043		0.049		0.055		0.064
18		0.048		0.046		0.048		0.054		0.061		0.070
20		0.053		0.051		0.053		0.058		0.066		0.077

ALU LINE
EZ LINE -
ENDMILL
SE 30
NITCO 30
OPTIMUM
SE 45
SE 45X
NITCO 45
SE 60
SE 60X
DN70 -
SE 70
SE GR
TE 45
PLUNGE
-MILL
THREAD
MILL

Recommended Cutting Data



Note: These recommended cutting data indicators are just for reference. They should be adjusted according to the different cutting condition

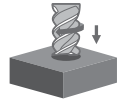

Optimum Endmills, 4 Flutes - 918, 981, 919, 991, K38, K47, K52, K53

Plunging	N						K		P			
Working Material	Wrought Aluminium		Cast Aluminium		Copper alloy		Grey Cast Iron		Carbon steel		Alloy steel	
Properties	Si < 9%		Si ≥ 9%		-		-		-		520 < Rm < 1200	
Cutting depth, ap	1.00 × D		1.00 × D		1.00 × D		1.00 × D		1.00 × D		1.00 × D	
Cutting Width, ae	-		-		-		-		-		-	
D	Vc	Fz	Vc	Fz	Vc	Fz	Vc	Fz	Vc	Fz	Vc	Fz
1		0.009		0.009		0.008		0.007		0.007		0.008
2		0.018		0.018		0.017		0.018		0.018		0.016
3		0.028		0.028		0.027		0.028		0.028		0.024
4		0.038		0.037		0.036		0.038		0.038		0.033
5		0.048		0.047		0.046		0.048		0.048		0.042
6		0.058		0.057		0.056		0.059		0.059		0.052
8	150	0.078	140	0.077	130	0.075	120	0.080	120	0.080	110	0.070
10		0.099		0.098		0.097		0.101		0.101		0.090
12		0.121		0.121		0.120		0.126		0.126		0.113
14		0.140		0.139		0.138		0.144		0.144		0.129
16		0.158		0.157		0.156		0.162		0.162		0.144
18		0.176		0.174		0.173		0.179		0.179		0.158
20		0.193		0.191		0.189		0.196		0.196		0.170

Optimum Endmills, 4 Flutes - 918, 981, 919, 991

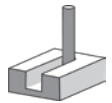

Trochoidal Milling	P						M		S			
Working Material	Carbon steel		Alloy steel		Prehardened steel		Stainless steel		Stainless steel		Titanium alloy	
Properties	-		520 < Rm < 1200		35 ≤ HRC < 45		High Machinability		Low Machinability		-	
Maximum Slot Width	1.25 × D		1.25 × D		1.25 × D		1.25 × D		1.25 × D		1.25 × D	
Cutting depth, ap	1.50 × D		1.50 × D		1.50 × D		1.50 × D		1.50 × D		1.50 × D	
Cutting Width, ae	0.10 × D		0.10 × D		0.08 × D		0.10 × D		0.08 × D		0.10 × D	
D	Vc	Fz	Vc	Fz	Vc	Fz	Vc	Fz	Vc	Fz	Vc	Fz
1		0.017		0.013		0.012		0.010		0.008		0.006
2		0.018		0.015		0.016		0.017		0.017		0.014
3		0.026		0.024		0.025		0.027		0.027		0.024
4		0.035		0.033		0.035		0.037		0.038		0.034
5		0.044		0.043		0.045		0.048		0.050		0.045
6		0.054		0.053		0.055		0.060		0.063		0.057
8	350	0.075	290	0.073	250	0.078	200	0.084	120	0.091	100	0.084
10		0.098		0.096		0.102		0.112		0.122		0.116
12		0.121		0.120		0.128		0.142		0.157		0.151
14		0.138		0.136		0.144		0.158		0.174		0.165
16		0.153		0.149		0.158		0.173		0.188		0.176
18		0.167		0.162		0.171		0.186		0.200		0.184
20		0.180		0.174		0.182		0.197		0.209		0.189

ALU LINE
ENDMILL
SE 30
SE 30
NITCo 30
OPTIMUM
SE 45
SE 45X
NITCo 45
SE 60
SE 60X
DM70 - SE70
SE GR
TE 45
PLUNGE-MILL
THREAD MILL

Recommended Cutting Data



Note: These recommended cutting data indicators are just for reference. They should be adjusted according to the different cutting condition



Optimum Endmills, 4 Flutes - 918, 981, 919, 991

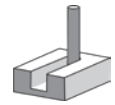

Trochoidal Milling	N						K				S	
Working Material	Wrought Aluminium		Cast Aluminium		Copper alloy		Grey Cast Iron		Ductile Cast Iron		Nickel Alloy	
Properties	Si < 9%		Si ≥ 9%		-		-		-		-	
Maximum Slot Width	1.25 × D		1.25 × D		1.25 × D		1.25 × D		1.25 × D		1.25 × D	
Cutting depth, ap	1.50 × D		1.50 × D		1.50 × D		1.50 × D		1.50 × D		1.50 × D	
Cutting Width, ae	0.12 × D		0.12 × D		0.12 × D		0.10 × D		0.10 × D		0.08 × D	
D	Vc	Fz	Vc	Fz	Vc	Fz	Vc	Fz	Vc	Fz	Vc	Fz
1	450	0.020	420	0.019	380	0.018	320	0.015	170	0.010	45	0.003
2		0.021		0.020		0.019		0.016		0.018		0.008
3		0.024		0.024		0.025		0.025		0.029		0.013
4		0.032		0.032		0.034		0.034		0.040		0.020
5		0.041		0.041		0.043		0.043		0.052		0.027
6		0.050		0.050		0.053		0.053		0.065		0.036
8		0.070		0.070		0.074		0.074		0.092		0.054
10		0.091		0.092		0.096		0.096		0.122		0.079
12		0.113		0.114		0.119		0.118		0.155		0.105
14		0.128		0.130		0.135		0.133		0.174		0.110
16		0.142		0.144		0.149		0.147		0.189		0.111
18		0.155		0.156		0.162		0.160		0.202		0.109
20	0.168	0.168	0.174	0.172	0.212	0.104						

ALU LINE
 EZ LINE -
 ENDMILL
 SE 30
 NITCO 30
OPTIMUM
 SE 45
 SE 45X
 NITCO 45
 SE 60
 SE 60X
 DN70 -
 SE 70
 SE GR
 TE 45
 PLUNGE
 -MILL
 THREAD
 MILL

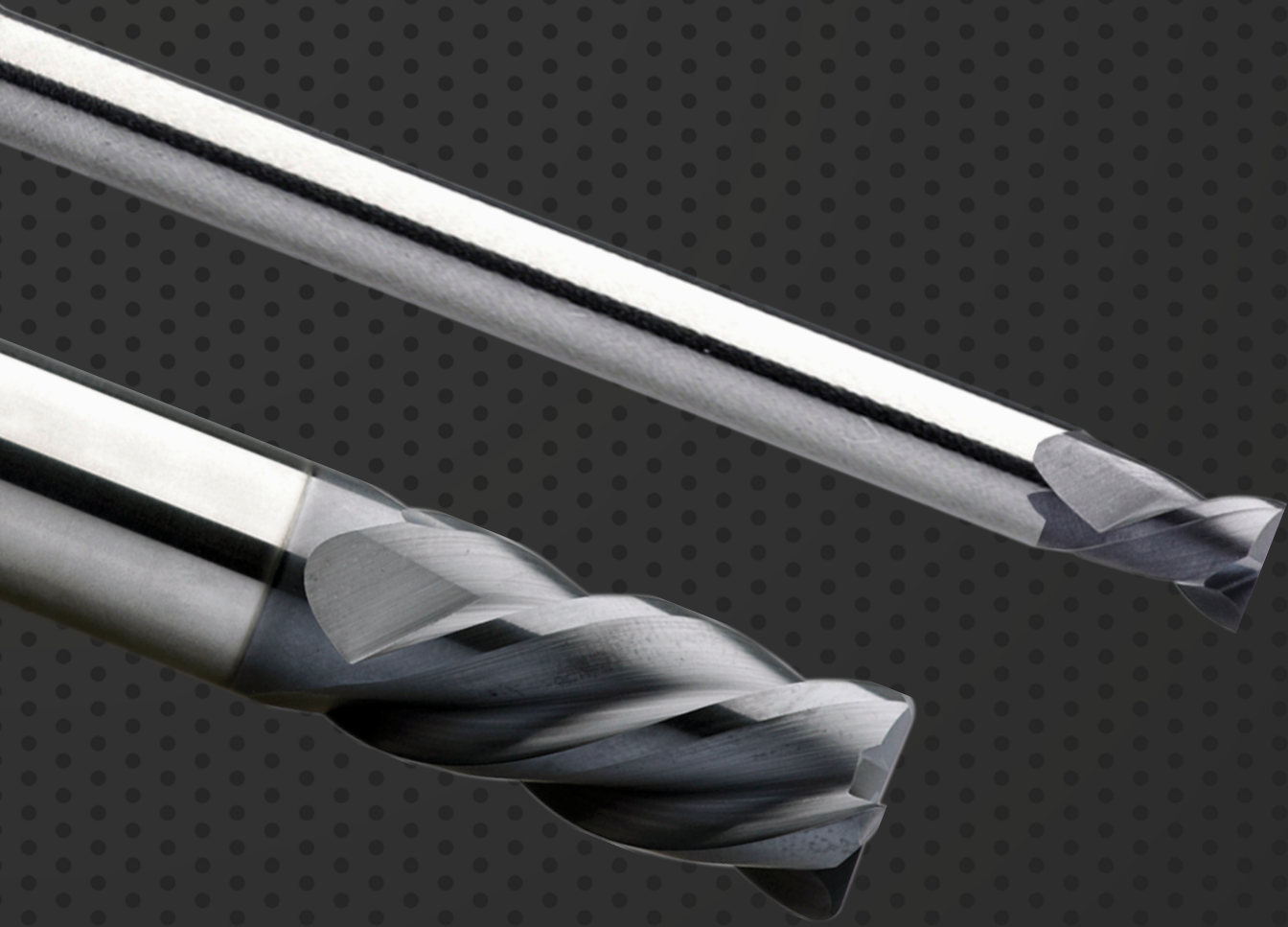

ENDMILLS

SE 45

For general machining

For material application between 36 HRC to 50 HRC

Index - SE 45, For 36 - 50 HRC

Suitable for Material Groups

Adapté pour les matériaux

适用于材料

Geeignet für die Materialgruppen

Adatto per il materiale



EDP Number	Type	No. Z	Helix Angle	Coating	Performance	Page Number
851	SE 45	4	30°	B0819	G	181
855	SE 45 Long	4	30°	B0819	G	182
859	SE 45 Extra-Long	4	30°	B0819	G	183
862	SE 45	4	40°	G6110	G	184
863	SE 45	4	40°	B0819	G	184
866	SE 45 Long	4	40°	G6110	G	185
867	SE 45 Long	4	40°	B0819	G	185
870	SE 45 Extra-Long	4	40°	G6110	G	186
871	SE 45 Extra-Long	4	40°	B0819	G	186
B30	SE 45R Torus	4	40°	B0819	G	187
B59	SE 45R Torus	4	40°	B0819	G	187
883	SE 45 Mini	2	40°	B0819	G	189
A01	SE 45 Mini	2	40°	B0909	G	189
885	SE 45 Miniature Long Neck	2	40°	B0819	G	190
A03	SE 45 Miniature Long Neck	2	40°	B0909	G	190
B66	SE 45R Miniature Long Neck Torus	2	40°	B0819	G	193
A79	SE 45R Miniature Long Neck Torus	2	40°	B0909	G	193
A25	SE 45R Taper Neck	2	40°	B0909	G	198
630	SE 45 Short Flute, Recess	3	40°	B0819	G	199
893	SE 45 Short Flute	3	40°	B0819	G	199
A14	SE 45 Short Flute	3	40°	B0909	G	199
A15	SE 45 Short Flute, Recess	3	40°	B0909	G	199
886	SE 45	2	40°	B0819	G	201
B31	SE 45, Recess	2	40°	B0819	G	201
A04	SE 45	2	40°	B0909	G	201
A05	SE 45, Recess	2	40°	B0909	G	201
186	SE 45 Long	4	40°	G6110	G	203
889	SE 45 Long	4	40°	B0819	G	203
A09	SE 45 Long	4	40°	B0909	G	203

G - General P - Performance

cont'd ►

Index - SE 45, For 36 - 50 HRC

Suitable for Material Groups
 Adapté pour les matériaux
 适用于材料
 Geeignet für die Materialgruppen
 Adatto per il materiale

P	M	K
S	H	

EDP Number	Type	No. Z	Helix Angle	Coating	Performance	Page Number
202	SE 45 Extra-Long	4	40°	G6110	G	204
891	SE 45 Extra-Long	4	40°	B0819	G	204
A11	SE 45 Extra-Long	4	40°	B0909	G	204
895	SE 45 Long Reach - Long	4	40°	B0819	G	205
897	SE 45 Long Reach - Long, Recess	4	40°	B0819	G	205
A18	SE 45 Long Reach - Long	4	40°	B0909	G	205
A19	SE 45 Long Reach - Long, Recess	4	40°	B0909	G	205
899	SE 45 Long Reach Extra-Long	4	40°	B0819	G	206
901	SE 45 Long Reach - Extra-Long, Recess	4	40°	B0819	G	206
A22	SE 45 Long Reach Extra-Long	4	40°	B0909	G	206
A23	SE 45 Long Reach - Extra-Long, Recess	4	40°	B0909	G	206
311	SE 45R Torus	4	40°	G6110	G	207
904	SE 45R Torus	4	40°	B0819	G	207
A26	SE 45R Torus	4	40°	B0909	G	208
786	SE 45R Long Reach Long, Recess	2	40°	B0819	G	211
906	SE 45R Long Reach Long	2	40°	B0819	G	211
A28	SE 45R Long Reach Long	2	40°	B0909	G	211
A99	SE 45R Long Reach Long, Recess	2	40°	B0909	G	211
813	SE 45R Long Reach Long, Recess	4	40°	B0819	G	212
907	SE 45R Long Reach Long	4	40°	B0819	G	212
A1B	SE 45R Long Reach Long	4	40°	B0909	G	212
A29	SE 45R Long Reach Long	4	40°	B0909	G	212
908	SE 45R Long Reach Extra-Long	2	40°	B0819	G	214
B32	SE 45R Long Reach Extra-Long	2	40°	B0819	G	214
A30	SE 45R Long Reach Extra-Long	2	40°	B0909	G	214
A31	SE 45R Long Reach Extra-Long, Recess	2	40°	B0909	G	214
909	SE 45R Long Reach Extra-Long	4	40°	B0819	G	215
B33	SE 45R Long Reach Extra-Long	4	40°	B0819	G	215
A32	SE 45R Torus Long Reach - Extra-Long	4	40°	B0909	G	215













G - General P - Performance

cont'd ►

Index - SE 45, For 36 - 50 HRC

Suitable for Material Groups
 Adapté pour les matériaux
 适用于材料
 Geeignet für die Materialgruppen
 Adatto per il materiale

P	M	K
S	H	

EDP Number	Type	No. Z	Helix Angle	Coating	Performance	Page Number
A33	 SE 45R Torus Long Reach - Extra-Long, Recess	4	40°	B0909	G	215
B71	 SE 45 Multiflute	6/8	50°	B0819	G	217
C14	 SE 45 Multiflute, Recess	6/8	50°	B0819	G	217
A89	 SE 45 Multiflute	6/8	50°	B0909	G	217
A94	 SE 45 Multiflute, Recess	6/8	50°	B0909	G	217
B73	 SE 45 Multiflute Long	6/8	50°	B0819	G	218
C15	 SE 45 Multiflute Long, Recess	6/8	50°	B0819	G	218
A90	 SE 45 Multiflute Long	6/8	50°	B0909	G	218
A95	 SE 45 Multiflute Long, Recess	6/8	50°	B0909	G	218
B78	 SE 45 Multiflute Extra-Long	6/8	50°	B0819	G	219
C16	 SE 45 Multiflute Extra-Long, Recess	6/8	50°	B0819	G	219
A91	 SE 45 Multiflute Extra-Long	6/8	50°	B0909	G	219
A96	 SE 45 Multiflute Extra-Long, Recess	6/8	50°	B0909	G	219

G - General P - Performance

FEATURES & BENEFITS

SE 45

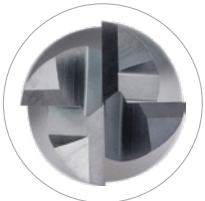

Top View

1 Gash Land Design



Significantly improves strength and provide great chipping resistance

2 Eccentric Grinding

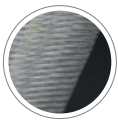

Optimum eccentric grinding in order to avoid rubbing, while maintaining maximum cutting tool strength.

3 Cutting Edge Preparation



- Enhances tool life
- Less material adhere on the cutting edge for stable machining
- Improves wear resistance and reduces excessive friction



4 Superior Coating to Reduce Friction

- Increases hardness and higher abrasive wear resistance
- Higher thermal resistance
- Smoother chips evacuation

5 Suitable for Material Groups





1. Stirnschliff Design
Verbessert die Leistung deutlich und bietet Schutz gegen Ausbrüche
2. Exzentrischer Schliff
Optimaler exzentrischer Schliff zur Reduzierung der Reibung unter Beibehaltung der maximalen Schneidenstabilität
3. Schneidkantenbehandlung
Verbessert die Werkzeuglebensdauer
Weniger Materialanhaftungen an der Schneide
Für stabile Bearbeitung
4. Ausgezeichnete Beschichtung zur Verringerung der Reibung
Erhöht die Härte und und bietet bessere Verschleißfestigkeit
Höhere Temperaturbeständigkeit
Glatte Oberfläche für besseren Spänefluß
5. Ungefähr Null Grad Spanwinkel
Geeignet für die Materialgruppen P, M, K, S, H



1. 底刀斜面式设计
显著提高强度, 提供极好的耐崩裂性。
2. 偏心研磨
最佳偏心研磨, 可避免摩擦, 同时保持最大切削刀具强度。
3. 切削刃设置提高刀具寿命
提高刀具寿命。
较少的材料粘粘在切削刃上。
用于稳定加工。
4. 优异的涂层, 减少摩擦
增加硬度, 提高材料耐磨性。
更高的抗热性。
更顺畅的排屑。
5. 接近于零度的前角
适用于材料 P、M、K、S、H



1. Struttura area sgrossatura
Migliora notevolmente la potenza e offre un'eccellente resistenza alle scheggiature
2. Levigatura orbitale
Levigatura orbitale ottimale per evitare sfregatura, garantendo la massima resistenza dello strumento di taglio.
3. Preparazione dell'angolo di taglio
Migliora la durata dello strumento
Meno materiale che aderisce sull'angolo di taglio
Per una lavorazione stabile
4. Rivestimento superiore per ridurre la frizione
Aumenta la durezza e una maggiore resistenza all'usura abrasiva
Resistenza termica superiore
Evacuazione dei trucioli più semplice
5. Angolo di taglio vicino allo zero
Adatto per il materiale P, M, K, S, H



1. Conception de fraise pour l'usinage general
Améliore considérablement la solidité et apporte une excellente résistance à l'ébarbage
2. Meulage excentrique
Meulage optimal diminuant le coefficient de friction tout en maintenant une bonne acuité de l'arête de coupe
3. Préparation des arêtes de coupes
Améliore la durée de vie de l'outil
Moins de matériau adhère à l'arête tranchante
Pour un usinage stable
4. Revêtement supérieur pour réduire la friction
Augmente la dureté et la résistance à l'abrasion
Résistance thermique supérieure
Évacuation des copeaux plus fluide
5. Angle de coupe proche de zéro °
Adapté pour les matériaux P, M, K, S, H

SE 45 ENDMILLS, 4 FLUTES

- VHM SE 45 Standard Fräser, 4 Zähne
- Frese SE 45, 4 taglienti
- Fraises SE 45 standard - 4 dents
- 整体硬质合金 SE 45 系列 4刀平底铣刀

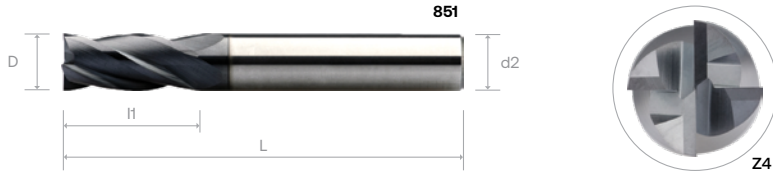

Order Number	Dimension (mm)					B0819
	D	l1	l2	L	d2 (h6)	
851 0100 040 03	1	3		40	3	•
851 0100 040 04				40	4	◦
851 0150 040 03	15	4.5		40	3	•
851 0150 040 04				40	4	•
851 0200 040 03	2	6.5		40	3	◦
851 0200 040 04				40	4	•
851 0250 040 03	2.5			40	3	•
851 0250 040 04				40	4	◦
851 0300	3	9		40	3	•
851 0300 050 06				50	6	•
851 0400	4	12		50	4	•
851 0400 050 06				50	6	•
851 0500	5	15		50	5	•
851 0500 050 06				50	6	◦
851 0600 050	6	16		50	6	•
851 0600 060				60	6	•
851 0800	8	20		64	8	•
851 1000 070	10	22		70	10	•
851 1000 075				75	10	•
851 1200	12	25		75	12	•
851 1400	14	32		90	14	•
851 1600	16			90	16	•
851 1800	18	38		100	18	•
851 2000	20			100	20	•
851 2200	22	40		100	22	◦
851 2500	25			100	25	◦

Material Group | Material-Gruppe | Groupe Matière | Gruppo Materiali | 材质主类

Cutting Parameter

N01	N02	N03	K01	K02	P01	P02	P03	M01	M02	S01	S02	S03	H01	H02	O01	O02	221
-----	-----	-----	-----	-----	-----	-----	-----	-----	-----	-----	-----	-----	-----	-----	-----	-----	-----

SE 45 LONG ENDMILLS, 4 FLUTES

- VHM SE45 Fräser, lang, 4 Zähne
- Frese lunghe SE 45, 4 taglienti
- Fraises SE 45 Longue - 4 dents
- 整体硬质合金 SE 45 系列 4刃长型平底铣刀

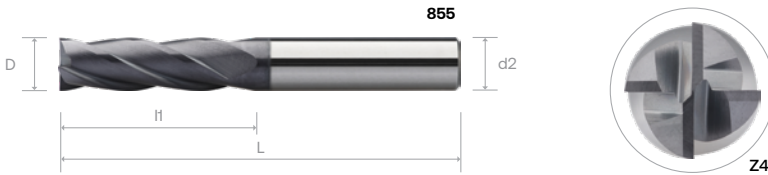

Order Number	Dimension (mm)					B0819
	D	L1	L2	L	d2 (h6)	
855 0300	3	19		60	3	•
855 0300 075 06				75	6	•
855 0400	4			60	4	•
855 0400 075 06				75	6	◦
855 0500	5			60	5	•
855 0500 075 06				75	6	◦
855 0600	6	31		75	6	◦
855 0800				8	8	•
855 1000 075	10			75	10	•
855 1000 100				50	100	10
855 1200	12				12	•
855 1400	14				14	•
855 1600	16	16	•			
855 1800	18	57		125	18	◦
855 2000				20	20	◦

- ALL LINE
- EZ LINE - ENDMILL
- SE 30
- NITICO 30
- OPTIMUM
- SE 45
- SE 45X
- NITICO 45
- SE 60
- SE 60X
- DN70 - SE70
- SE GR
- TE 45
- PLUNGE -MILL
- THREAD MILL

Material Group | Material-Gruppe | Groupe Matière | Gruppo Materiali | 材质主类

Cutting Parameter

N01 N02 N03 K01 K02 P01 P02 P03 M01 M02 S01 S02 S03 H01 H02 O01 O02

222

SE 45 EXTRA-LONG ENDMILLS, 4 FLUTES

- VHM SE45 Fräser, extra-lang, 4 Zähne
- Frese extra-lunghe SE 45, 4 taglianti
- Fraises SE 45 Extra-Longue- 4 dents
- 整体硬质合金 SE 45 系列 4刃加长型平底铣刀



Order Number	Dimension (mm)					B0819
	D	L1	L2	L	d2 (h6)	
859 0300	3	25		100	3	•
859 0300 100 06				100	6	◦
859 0400	4	31		100	4	•
859 0400 100 06				100	6	◦
859 0500	5			100	5	•
859 0500 100 06				100	6	◦
859 0600	6	38		100	6	•
859 0800	8	41		100	8	•
859 1000	10	57		125	10	◦
859 1200	12	75		150	12	•
859 1400	14			150	14	◦
859 1600	16			150	16	◦
859 1800	18			150	18	◦
859 2000	20			150	20	◦

Material Group | Material-Gruppe | Groupe Matière | Gruppo Materiali | 材质主类

Cutting Parameter

N01	N02	N03	K01	K02	P01	P02	P03	M01	M02	S01	S02	S03	H01	H02	O01	O02	222
-----	-----	-----	-----	-----	-----	-----	-----	-----	-----	-----	-----	-----	-----	-----	-----	-----	-----

SE 45 ENDMILLS, 4 FLUTES

- VHM SE 45 Standard Fräser, 4 Zähne
- Frese SE 45, 4 taglienti
- Fraises SE 45 standard - 4 dents
- 整体硬质合金 SE 45 系列 4刃平底铣刀

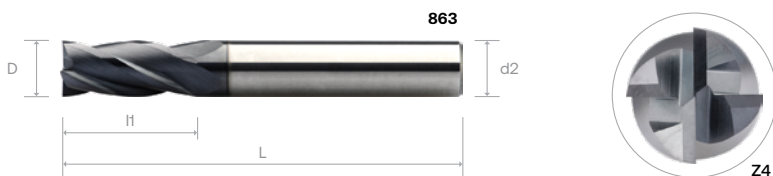
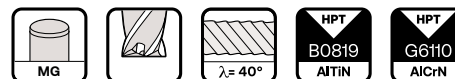

Order Number	Dimension (mm)					G6110	Order Number	Dimension (mm)					B0819
	D	l1	l2	L	d2 (h6)			D	l1	l2	L	d2 (h6)	
862 0100 040 03	1	3		40	3	•	863 0100 040 03	1	3		40	3	◦
862 0100 040 04				40	4	◦	863 0100 040 04				40	4	◦
862 0150 040 03	1.5	4.5		40	3	◦	863 0150 040 03	1.5	4.5		40	3	◦
862 0150 040 04 *				40	4	◦	863 0150 040 04 *				40	4	◦
862 0200 040 03 *	2	6.5		40	3	•	863 0200 040 03 *	2	6.5		40	3	◦
862 0200 040 04				40	4	◦	863 0200 040 04				40	4	◦
862 0250 040 03 *	2.5			40	3	◦	863 0250 040 03 *	2.5			40	3	◦
862 0250 040 04				40	4	•	863 0250 040 04				40	4	◦
862 0300	3	9		40	3	◦	863 0300	3	9		40	3	•
862 0300 050 04				50	4	•	863 0300 050 04				50	4	◦
862 0300 050 06				50	6	•	863 0300 050 06				50	6	•
862 0400	4	12		50	4	•	863 0400	4	12		50	4	•
862 0400 050 06				50	6	•	863 0400 050 06				50	6	•
862 0500	5	15		50	5	•	863 0500	5	15		50	5	•
862 0500 050 06				50	6	•	863 0500 050 06				50	6	◦
862 0600 050	6	16		50	6	•	863 0600 050	6	16		50	6	•
862 0600 060		20		60	6	•	863 0600 060		20		60	6	•
862 0800	8			64	8	•	863 0800	8			64	8	•
862 1000 070	10	22		70	10	•	863 1000 070	10	22		70	10	•
862 1000 075				75	10	•	863 1000 075				75	10	◦
862 1200	12	25		75	12	•	863 1200	12	25		75	12	•
862 1400	14	32		90	14	•	863 1400	14	32		90	14	•
862 1600	16			90	16	•	863 1600	16			90	16	•
862 1800	18	38		100	18	◦	863 1800	18	38		100	18	◦
862 2000	20			100	20	◦	863 2000	20			100	20	◦
862 2200	22	40		100	22	◦	863 2200	22	40		100	22	◦
862 2500	25			100	25	◦	863 2500	25			100	25	◦

* - DIN 6535

- ALL LINE
- EZ LINE - ENDMILL
- SE 30
- NITICO 30
- OPTIMUM
- SE 45
- SE 45X
- NITICO 45
- SE 60
- SE 60X
- DM70 - SE70
- SE GR
- TE 45
- PLUNGE -MILL
- THREAD MILL

Material Group | Material-Gruppe | Groupe Matière | Gruppo Materiali | 材质主类

Cutting Parameter

N01	N02	N03	K01	K02	P01	P02	P03	M01	M02	S01	S02	S03	H01	H02	O01	O02
-----	-----	-----	-----	-----	-----	-----	-----	-----	-----	-----	-----	-----	-----	-----	-----	-----

221

SE 45 LONG ENDMILLS, 4 FLUTES

- VHM SE45 Fräser, lang, 4 Zähne
- Frese lunghe SE 45, 4 taglienti
- Fraises SE45 Longue - 4 dents
- 整体硬质合金 SE 45 系列 4刃长型平底铣刀

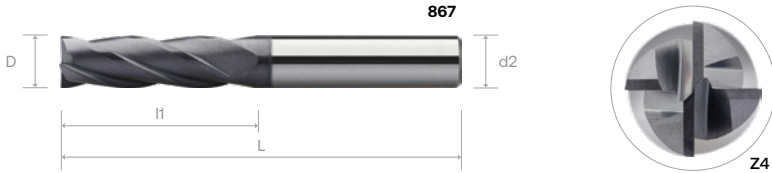

Order Number	Dimension (mm)						G6110	Order Number	Dimension (mm)						B0819
	D	l1	l2	L	d2 (h6)				D	l1	l2	L	d2 (h6)		
866 0300	3	19		60	3	•	867 0300	3	19		60	3	•		
866 0300 075 06				75	6	◦	867 0300 075 06				75	6	◦		
866 0400			4		60	4	•			867 0400	4		60	4	•
866 0400 075 06				75	6	◦	867 0400 075 06			75		6	◦		
866 0500	5				60	5	◦	867 0500		5			60	5	•
866 0500 075 06				75	6	◦	867 0500 075 06				75	6	◦		
866 0600		6	31		75	6	•	867 0600	6		31		75	6	•
866 0800	8				75	8	•	867 0800		8			75	8	•
866 1000 075				10		75	10	•				867 1000 075	10		75
866 1000 100		50			100	10	•	867 1000 100	50			100		10	•
866 1200	12				100	12	•	867 1200		12		100		12	•
866 1400			14		125	14	•	867 1400			14		125	14	◦
866 1600		16		57		125	16	•	867 1600			16		125	16
866 1800	18					125	18	◦	867 1800	18				125	18
866 2000			20			125	20	◦	867 2000		20			125	20

Material Group | Material-Gruppe | Groupe Matière | Gruppo Materiali | 材质主类

Cutting Parameter

N01	N02	N03	K01	K02	P01	P02	P03	M01	M02	S01	S02	S03	H01	H02	O01	O02	222
-----	-----	-----	-----	-----	-----	-----	-----	-----	-----	-----	-----	-----	-----	-----	-----	-----	-----

SE 45 EXTRA-LONG ENDMILLS, 4 FLUTES

- VHM SE45 Fräser,extra-lang, 4 Zähne
- Frese extra-lunghe SE 45, 4 taglienti
- Fraises SE 45 Extra-Longue- 4 dents
- 整体硬质合金 SE 45 系列 4刃加长型平底铣刀

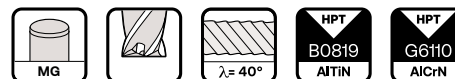

Order Number	Dimension (mm)					G6110	Order Number	Dimension (mm)					B0819
	D	I1	I2	L	d2 (h6)			D	I1	I2	L	d2 (h6)	
870 0300				100	3	•	871 0300				100	3	•
870 0300 100 06	3	3		100	6	•	871 0300 100 06	3	3		100	6	◦
870 0400				100	4	•	871 0400				100	4	•
870 0400 100 06	4	4		100	6	◦	871 0400 100 06	4	4		100	6	◦
870 0500				100	5	•	871 0500				100	5	◦
870 0500 100 06	5	5		100	6	◦	871 0500 100 06	5	5		100	6	◦
870 0600				100	6	•	871 0600				100	6	•
870 0800				100	8	◦	871 0800				100	8	•
870 1000				125	10	•	871 1000				125	10	•
870 1200				150	12	•	871 1200				150	12	◦
870 1400				150	14	◦	871 1400				150	14	•
870 1600				150	16	•	871 1600				150	16	•
870 1800				150	18	◦	871 1800				150	18	◦
870 2000				150	20	•	871 2000				150	20	•

- ALL LINE
- EZ LINE - ENDMILL
- SE 30
- NITICO 30
- OPTIMUM
- SE 45
- SE 45X
- NITICO 45
- SE 60
- SE 60X
- DM70 - SE 70
- SE GR
- TE 45
- PLUNGE -MILL
- THREAD MILL

Material Group | Material-Gruppe | Groupe Matière | Gruppo Materiali | 材质主类

Cutting Parameter

N01	N02	N03	K01	K02	P01	P02	P03	M01	M02	S01	S02	S03	H01	H02	O01	O02
-----	-----	-----	-----	-----	-----	-----	-----	-----	-----	-----	-----	-----	-----	-----	-----	-----

222

SE 45R TORUS ENDMILLS, 4 FLUTES

- VHM SE 45R Standard Torusfräser, 4 Zähne
- Frese toroidali SE 45, 4 taglienti
- Fraises SE 45 toriques Standard, 4 dents
- 整体硬质合金 SE 45R 系列 4刃圆鼻铣刀

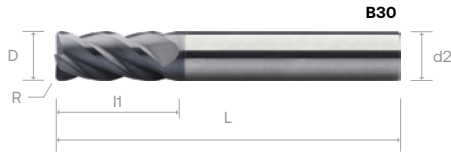

Order Number	Dimension (mm)						B0819	Order Number	Dimension (mm)						G6110
	D	I1	I2	L	d2 (h6)	R			D	I1	I2	L	d2 (h6)	R	
B30 0100 040 0400 020	1	3		40	4	0.2	°	B59 0100 040 0400 020	1	3		40	4	0.2	°
B30 0100 050 0600 020				50	6	0.2	°	B59 0100 050 0600 020				50	6	0.2	°
B30 0150 040 0400 020	1.5	4.5		40	4	0.2	°	B59 0150 040 0400 020	1.5	4.5		40	4	0.2	°
B30 0150 050 0600 020				50	6	0.2	°	B59 0150 050 0600 020				50	6	0.2	°
B30 0200 040 0400 020	2			40	4	0.2	°	B59 0200 040 0400 020	2			40	4	0.2	°
B30 0200 040 0400 030				40	4	0.3	°	B59 0200 040 0400 030				40	4	0.3	°
B30 0200 050 0600 020	2			50	6	0.2	°	B59 0200 050 0600 020	2			50	6	0.2	°
B30 0200 050 0600 030				50	6	0.3	°	B59 0200 050 0600 030				50	6	0.3	°
B30 0250 040 0400 020	2.5	6.5		40	4	0.2	°	B59 0250 040 0400 020	2.5	6.5		40	4	0.2	°
B30 0250 040 0400 030				40	4	0.3	°	B59 0250 040 0400 030				40	4	0.3	°
B30 0250 040 0400 050	2.5	6.5		40	4	0.5	°	B59 0250 040 0400 050	2.5	6.5		40	4	0.5	°
B30 0250 050 0600 020				50	6	0.2	°	B59 0250 050 0600 020				50	6	0.2	°
B30 0250 050 0600 030	2.5	6.5		50	6	0.3	°	B59 0250 050 0600 030	2.5	6.5		50	6	0.3	°
B30 0250 050 0600 050				50	6	0.5	°	B59 0250 050 0600 050				50	6	0.5	°
B30 0300 040 0300 020	3	9		40	3	0.2	°	B59 0300 040 0300 020	3	9		40	3	0.2	°
B30 0300 040 0300 030				40	3	0.3	°	B59 0300 040 0300 030				40	3	0.3	°
B30 0300 040 0300 050	3	9		40	3	0.5	°	B59 0300 040 0300 050	3	9		40	3	0.5	°
B30 0300 040 0400 020				40	4	0.2	°	B59 0300 040 0400 020				40	4	0.2	°
B30 0300 040 0400 030	3	9		40	4	0.3	°	B59 0300 040 0400 030	3	9		40	4	0.3	°
B30 0300 040 0400 050				40	4	0.5	°	B59 0300 040 0400 050				40	4	0.5	°
B30 0300 050 0600 020	3	9		50	6	0.2	°	B59 0300 050 0600 020	3	9		50	6	0.2	°
B30 0300 050 0600 030				50	6	0.3	°	B59 0300 050 0600 030				50	6	0.3	°
B30 0300 050 0600 050	3	9		50	6	0.5	°	B59 0300 050 0600 050	3	9		50	6	0.5	°
B30 0400 050 0400 020			4	12		50	4	0.2			°	B59 0400 050 0400 020	4	12	
B30 0400 050 0400 030		50			4	0.3	°	B59 0400 050 0400 030		50	4	0.3			°
B30 0400 050 0400 050	4	12		50	4	0.5	°	B59 0400 050 0400 050	4	12		50	4	0.5	°
B30 0400 050 0400 100				50	4	1	°	B59 0400 050 0400 100				50	4	1	°
B30 0400 050 0600 020	4	12		50	6	0.2	°	B59 0400 050 0600 020	4	12		50	6	0.2	°
B30 0400 050 0600 030				50	6	0.3	°	B59 0400 050 0600 030				50	6	0.3	°
B30 0400 050 0600 050	4	12		50	6	0.5	°	B59 0400 050 0600 050	4	12		50	6	0.5	°
B30 0400 050 0600 100				50	6	1	°	B59 0400 050 0600 100				50	6	1	°
B30 0500 050 0500 020	5	15		50	5	0.2	°	B59 0500 050 0500 020	5	15		50	5	0.2	°
B30 0500 050 0500 030				50	5	0.3	°	B59 0500 050 0500 030				50	5	0.3	°
B30 0500 050 0500 050	5	15		50	5	0.5	°	B59 0500 050 0500 050	5	15		50	5	0.5	°
B30 0500 050 0500 100				50	5	1	°	B59 0500 050 0500 100				50	5	1	°
B30 0500 050 0600 020	5	15		50	6	0.2	°	B59 0500 050 0600 020	5	15		50	6	0.2	°
B30 0500 050 0600 030				50	6	0.3	°	B59 0500 050 0600 030				50	6	0.3	°
B30 0500 050 0600 050	5	15		50	6	0.5	°	B59 0500 050 0600 050	5	15		50	6	0.5	°
B30 0500 050 0600 100				50	6	1	°	B59 0500 050 0600 100				50	6	1	°
B30 0600 050 0600 020	6	16		50	6	0.2	°	B59 0600 050 0600 020	6	16		50	6	0.2	°
B30 0600 050 0600 030				50	6	0.3	°	B59 0600 050 0600 030				50	6	0.3	°
B30 0600 050 0600 050	6	16		50	6	0.5	°	B59 0600 050 0600 050	6	16		50	6	0.5	°
B30 0600 050 0600 100				50	6	1	°	B59 0600 050 0600 100				50	6	1	°
B30 0600 060 0600 020	6	20		60	6	0.2	°	B59 0600 060 0600 020	6	20		60	6	0.2	°
B30 0600 060 0600 030				60	6	0.3	°	B59 0600 060 0600 030				60	6	0.3	°

cont'd ▶

Material Group | Material-Gruppe | Groupe Matière | Gruppo Materiali | 材质主类

Cutting Parameter

N01	N02	N03	K01	K02	P01	P02	P03	M01	M02	S01	S02	S03	H01	H02	O01	O02	221
-----	-----	-----	-----	-----	-----	-----	-----	-----	-----	-----	-----	-----	-----	-----	-----	-----	-----

SE 45R TORUS ENDMILLS, 4 FLUTES

- VHM SE 45R Standard Torusfräser, 4 Zähne
- Frese toroidali SE 45, 4 taglianti
- Fraises SE 45 toriques Standard, 4 dents
- 整体硬质合金 SE 45R 系列 4刃圆鼻铣刀

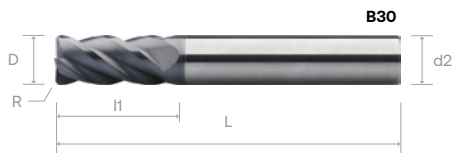
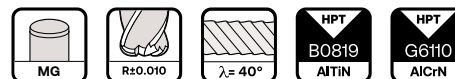

Order Number	Dimension (mm)						B0819	Order Number	Dimension (mm)						G6110
	D	l1	l2	L	d2 (h6)	R			D	l1	l2	L	d2 (h6)	R	
B30 0600 060 0600 050	6	20		60	6	0.5	•	B59 0600 060 0600 050	6	20		60	6	0.5	•
B30 0600 060 0600 100				60	6	1	◦	B59 0600 060 0600 100				60	6	1	◦
B30 0800 064 0800 020	8			64	8	0.2	•	B59 0800 064 0800 020	8			64	8	0.2	•
B30 0800 064 0800 030				64	8	0.3	◦	B59 0800 064 0800 030				64	8	0.3	•
B30 0800 064 0800 050				64	8	0.5	◦	B59 0800 064 0800 050				64	8	0.5	•
B30 0800 064 0800 100				64	8	1	•	B59 0800 064 0800 100				64	8	1	•
B30 0800 064 0800 150	10	64	8	1.5	•	B59 0800 064 0800 150	10	64	8	1.5	•				
B30 0800 064 0800 200		64	8	2	◦	B59 0800 064 0800 200		64	8	2	◦				
B30 1000 070 1000 030		22	70	10	0.3	•		B59 1000 070 1000 030	22	70	10	0.3	•		
B30 1000 070 1000 050			70	10	0.5	•		B59 1000 070 1000 050		70	10	0.5	•		
B30 1000 070 1000 100	70		10	1	•	B59 1000 070 1000 100	70	10		1	•				
B30 1000 070 1000 150	70		10	1.5	◦	B59 1000 070 1000 150	70	10		1.5	◦				
B30 1000 070 1000 200	70		10	2	•	B59 1000 070 1000 200	70	10		2	•				
B30 1000 075 1000 030	25		75	10	0.3	•	B59 1000 075 1000 030	25		75	10	0.3	◦		
B30 1000 075 1000 050		75	10	0.5	◦	B59 1000 075 1000 050	75		10	0.5	◦				
B30 1000 075 1000 100		75	10	1	◦	B59 1000 075 1000 100	75		10	1	◦				
B30 1000 075 1000 150		75	10	1.5	◦	B59 1000 075 1000 150	75		10	1.5	◦				
B30 1000 075 1000 200		75	10	2	◦	B59 1000 075 1000 200	75		10	2	◦				
B30 1200 075 1200 030		12	75	12	0.3	◦	B59 1200 075 1200 030		12	75	12	0.3	◦		
B30 1200 075 1200 050	75		12	0.5	•	B59 1200 075 1200 050	75	12		0.5	•				
B30 1200 075 1200 100	75		12	1	•	B59 1200 075 1200 100	75	12		1	•				
B30 1200 075 1200 150	75		12	1.5	•	B59 1200 075 1200 150	75	12		1.5	•				
B30 1200 075 1200 200	75		12	2	•	B59 1200 075 1200 200	75	12		2	•				
B30 1200 075 1200 300	75		12	3	•	B59 1200 075 1200 300	75	12		3	◦				
B30 1400 090 1400 050	14	32	90	14	0.5	◦	B59 1400 090 1400 050	32	90	14	0.5	◦			
B30 1400 090 1400 100			90	14	1	◦	B59 1400 090 1400 100		90	14	1	◦			
B30 1400 090 1400 150			90	14	1.5	◦	B59 1400 090 1400 150		90	14	1.5	◦			
B30 1400 090 1400 200			90	14	2	◦	B59 1400 090 1400 200		90	14	2	◦			
B30 1400 090 1400 300			90	14	3	◦	B59 1400 090 1400 300		90	14	3	◦			
B30 1600 090 1600 050			16	90	16	0.5	•		B59 1600 090 1600 050	16	90	16	0.5	◦	
B30 1600 090 1600 100	90	16		1	•	B59 1600 090 1600 100	90	16	1		◦				
B30 1600 090 1600 150	90	16		1.5	◦	B59 1600 090 1600 150	90	16	1.5		◦				
B30 1600 090 1600 200	90	16		2	•	B59 1600 090 1600 200	90	16	2		◦				
B30 1600 090 1600 300	90	16		3	◦	B59 1600 090 1600 300	90	16	3		◦				
B30 1800 100 1800 050	18	100		18	0.5	◦	B59 1800 100 1800 050	18	100		18	0.5	◦		
B30 1800 100 1800 100		100	18	1	◦	B59 1800 100 1800 100	100		18	1	◦				
B30 1800 100 1800 150		100	18	1.5	◦	B59 1800 100 1800 150	100		18	1.5	◦				
B30 1800 100 1800 200		100	18	2	◦	B59 1800 100 1800 200	100		18	2	◦				
B30 1800 100 1800 300		100	18	3	◦	B59 1800 100 1800 300	100		18	3	◦				
B30 2000 100 2000 050		20	38	100	20	0.5	◦		B59 2000 100 2000 050	38	100	20	0.5	◦	
B30 2000 100 2000 100	100			20	1	◦	B59 2000 100 2000 100	100	20		1	◦			
B30 2000 100 2000 150	100			20	1.5	◦	B59 2000 100 2000 150	100	20		1.5	◦			
B30 2000 100 2000 200	100			20	2	◦	B59 2000 100 2000 200	100	20		2	◦			
B30 2000 100 2000 300			100	20	3	◦	B59 2000 100 2000 300			100	20	3	◦		

ALL LINE
 EZ LINE -
 ENDMILL
 SE 30
 NITCO 30
 OPTIMUM
 SE 45
 SE 45X
 NITCO 45
 SE 60
 SE 60X
 DN70 -
 SE 70
 SE GR
 TE 45
 PLUNGE
 -MILL
 THREAD
 MILL

Material Group | Material-Gruppe | Groupe Matière | Gruppo Materiali | 材质主类

Cutting Parameter

N01	N02	N03	K01	K02	P01	P02	P03	M01	M02	S01	S02	S03	H01	H02	O01	O02
-----	-----	-----	-----	-----	-----	-----	-----	-----	-----	-----	-----	-----	-----	-----	-----	-----

221

SE 45 MINIATURE ENDMILLS, 2 FLUTES

- VHM SE 45 Kleinfräser, 2 Zähne
- Micro-frese SE 45, 2 taglienti
- Micro-Fraises SE 45, 2 dents
- 整体硬质合金 SE 45 系列 微小径 2刃平底铣刀



Order Number	Dimension (mm)					B0819	Order Number	Dimension (mm)					B0909
	D	l1	l2	L	d2 (h6)			D	l1	l2	L	d2 (h6)	
883 0100 040 03	0.1	0.2		40	3	•	A01 0100 040 03	0.1	0.2		40	3	◦
883 0100 040 04				40	4	•	A01 0100 040 04				40	4	•
883 0150 040 03	0.2	0.4		40	3	◦	A01 0150 040 03	0.2	0.4		40	3	◦
883 0150 040 04				40	4	•	A01 0150 040 04				40	4	◦
883 0200 040 03	0.3	0.6		40	3	◦	A01 0200 040 03	0.3	0.6		40	3	◦
883 0200 040 04				40	4	•	A01 0200 040 04				40	4	◦
883 0250 040 03	0.4	0.8		40	3	•	A01 0250 040 03	0.4	0.8		40	3	◦
883 0250 040 04				40	4	•	A01 0250 040 04				40	4	•
883 0300	0.5	1.0		40	3	•	A01 0300	0.5	1.0		40	3	•
883 0300 050 04				40	4	•	A01 0300 050 04				40	4	•
883 0300 050 06	0.6	1.2		40	3	◦	A01 0300 050 06	0.6	1.2		40	3	◦
883 0400				40	4	•	A01 0400				40	4	◦
883 0400 050 06	0.7	1.4		40	3	•	A01 0400 050 06	0.7	1.4		40	3	◦
883 0500				40	4	◦	A01 0500				40	4	•
883 0500 050 06	0.8	1.6		40	3	•	A01 0500 050 06	0.8	1.6		40	3	◦
883 0600 050				40	4	•	A01 0600 050				40	4	•
883 0600 060	0.9	1.8		40	3	◦	A01 0600 060	0.9	1.8		40	3	◦
883 0800				40	4	•	A01 0800				40	4	◦
883 1000 070	1.0	2		40	3	◦	A01 1000 070	1.0	2		40	3	•
883 1000 075	1.1	2.2		40	3	•	A01 1000 075	1.1	2.2		40	3	◦
883 1200	1.2	2.4		40	3	◦	A01 1200	1.2	2.4		40	3	•
883 1200	1.3	2.6		40	3	◦	A01 1200	1.3	2.6		40	3	•
883 1200	1.4	2.8		40	3	•	A01 1200	1.4	2.8		40	3	◦
883 1400	1.5	3		40	3	•	A01 1400	1.5	3		40	3	•
883 1600	1.6	3.2		40	3	•	A01 1600	1.6	3.2		40	3	◦
883 1800	1.7	3.4		40	3	•	A01 1800	1.7	3.4		40	3	◦
883 2000	1.8	3.6		40	3	◦	A01 2000	1.8	3.6		40	3	•
883 2200	1.9	3.8		40	3	◦	A01 2200	1.9	3.8		40	3	◦
883 2500	2.0	4		40	3	◦	A01 2500	2.0	4		40	3	•

D mm	Tol. μm
0.1 - 0.7	0 / -12
0.7 - 4.0	0 / -20

Material Group | Material-Gruppe | Groupe Matière | Gruppo Materiali | 材质主类

Cutting Parameter

N01	N02	N03	K01	K02	P01	P02	P03	M01	M02	S01	S02	S03	H01	H02	O01	O02	229
-----	-----	-----	-----	-----	-----	-----	-----	-----	-----	-----	-----	-----	-----	-----	-----	-----	-----

SE 45 MINIATURE ENDMILLS WITH LONG NECK, 2 FLUTES

- VHM SE 45 Kleinstfräser mit langem Hals, 2 Zähne
- Micro-frese SE 45, con collo lungo, 2 taglienti
- Micro-fraises SE 45 avec cou long, 2 dents
- 整体硬质合金 SE 45 系列 微小径2刃长颈平底铣刀

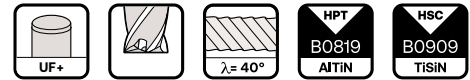

Order Number	Dimension (mm)						B0819	Order Number	Dimension (mm)						B0909
	D	l1	l2	L	d1	d2 (h6)			D	l1	l2	L	d1	d2 (h6)	
885 0020 050 0400	0.2	0.3	-	50	-	4	°	A03 0020 050 0400	0.2	0.3	-	50	-	4	•
885 0020 050 0400 005			0.5	50	0.17	4	•	A03 0020 050 0400 005			0.5	50	0.17	4	°
885 0020 050 0400 010			1	50	0.17	4	•	A03 0020 050 0400 010			1	50	0.17	4	•
885 0020 050 0400 015	0.3	0.4	1.5	50	0.17	4	°	A03 0020 050 0400 015	0.3	0.4	1.5	50	0.17	4	°
885 0030 050 0400			-	50	-	4	°	A03 0030 050 0400			-	50	-	4	•
885 0030 050 0400 010			1	50	0.27	4	°	A03 0030 050 0400 010			1	50	0.27	4	•
885 0030 050 0400 020	0.4	0.6	2	50	0.27	4	•	A03 0030 050 0400 020	0.4	0.6	2	50	0.27	4	•
885 0030 050 0400 030			3	50	0.27	4	°	A03 0030 050 0400 030			3	50	0.27	4	°
885 0040 050 0400			-	50	-	4	°	A03 0040 050 0400			-	50	-	4	°
885 0040 050 0400 020	0.5	0.7	2	50	0.37	4	•	A03 0040 050 0400 020	0.5	0.7	2	50	0.37	4	•
885 0040 050 0400 030			3	50	0.37	4	°	A03 0040 050 0400 030			3	50	0.37	4	•
885 0040 050 0400 040			4	50	0.37	4	°	A03 0040 050 0400 040			4	50	0.37	4	•
885 0040 050 0400 050	0.6	0.9	5	50	0.37	4	°	A03 0040 050 0400 050	0.6	0.9	5	50	0.37	4	°
885 0050 050 0400			-	50	-	4	°	A03 0050 050 0400			-	50	-	4	•
885 0050 050 0400 020			2	50	0.45	4	•	A03 0050 050 0400 020			2	50	0.45	4	•
885 0050 050 0400 040	0.7	1.0	4	50	0.45	4	•	A03 0050 050 0400 040	0.7	1.0	4	50	0.45	4	•
885 0050 050 0400 060			6	50	0.45	4	°	A03 0050 050 0400 060			6	50	0.45	4	•
885 0050 050 0400 080			8	50	0.45	4	•	A03 0050 050 0400 080			8	50	0.45	4	•
885 0060 050 0400	0.8	1.2	-	50	-	4	°	A03 0060 050 0400	0.8	1.2	-	50	-	4	°
885 0060 050 0400 020			2	50	0.55	4	•	A03 0060 050 0400 020			2	50	0.55	4	•
885 0060 050 0400 040			4	50	0.55	4	•	A03 0060 050 0400 040			4	50	0.55	4	•
885 0060 050 0400 060	0.9	1.4	6	50	0.55	4	°	A03 0060 050 0400 060	0.9	1.4	6	50	0.55	4	•
885 0060 050 0400 080			8	50	0.55	4	°	A03 0060 050 0400 080			8	50	0.55	4	•
885 0060 050 0400 100			10	50	0.55	4	•	A03 0060 050 0400 100			10	50	0.55	4	•
885 0070 050 0400	1.0	1.5	-	50	-	4	°	A03 0070 050 0400	1.0	1.5	-	50	-	4	°
885 0070 050 0400 020			2	50	0.65	4	°	A03 0070 050 0400 020			2	50	0.65	4	°
885 0070 050 0400 040			4	50	0.65	4	°	A03 0070 050 0400 040			4	50	0.65	4	•
885 0070 050 0400 060	0.8	1.2	6	50	0.65	4	°	A03 0070 050 0400 060	0.8	1.2	6	50	0.65	4	°
885 0070 050 0400 080			8	50	0.65	4	°	A03 0070 050 0400 080			8	50	0.65	4	°
885 0070 050 0400 100			10	50	0.65	4	°	A03 0070 050 0400 100			10	50	0.65	4	°
885 0080 050 0400	0.9	1.4	-	50	-	4	°	A03 0080 050 0400	0.9	1.4	-	50	-	4	•
885 0080 050 0400 040			4	50	0.75	4	•	A03 0080 050 0400 040			4	50	0.75	4	•
885 0080 050 0400 060			6	50	0.75	4	•	A03 0080 050 0400 060			6	50	0.75	4	•
885 0080 050 0400 080	1.0	1.5	8	50	0.75	4	°	A03 0080 050 0400 080	1.0	1.5	8	50	0.75	4	•
885 0080 050 0400 100			10	50	0.75	4	•	A03 0080 050 0400 100			10	50	0.75	4	•
885 0080 050 0400 120			12	50	0.75	4	•	A03 0080 050 0400 120			12	50	0.75	4	•
885 0090 050 0400	0.9	1.4	-	50	-	4	°	A03 0090 050 0400	0.9	1.4	-	50	-	4	•
885 0090 050 0400 060			6	50	0.85	4	°	A03 0090 050 0400 060			6	50	0.85	4	•
885 0090 050 0400 080			8	50	0.85	4	°	A03 0090 050 0400 080			8	50	0.85	4	°
885 0090 050 0400 100	1.0	1.5	10	50	0.85	4	°	A03 0090 050 0400 100	1.0	1.5	10	50	0.85	4	°
885 0090 050 0400 150 *			15	50	0.85	4	°	A03 0090 050 0400 150 *			15	50	0.85	4	°
885 0100 050 0400			-	50	-	4	°	A03 0100 050 0400			-	50	-	4	•
885 0100 050 0400 060	1.0	1.5	6	50	0.9	4	•	A03 0100 050 0400 060	1.0	1.5	6	50	0.9	4	•
885 0100 050 0400 080			8	50	0.9	4	•	A03 0100 050 0400 080			8	50	0.9	4	•
885 0100 050 0400 100			10	50	0.9	4	•	A03 0100 050 0400 100			10	50	0.9	4	•

* - DIN 6535

cont'd ▶

Material Group | Material-Gruppe | Groupe Matiere | Gruppo Materiali | 材质主类

Cutting Parameter

N01	N02	N03	K01	K02	P01	P02	P03	M01	M02	S01	S02	S03	H01	H02	O01	O02
			○				○		○		○		●			

227 - 229

SE 45 MINIATURE ENDMILLS WITH LONG NECK, 2 FLUTES

- VHM SE 45 Kleinfräser mit langem Hals, 2 Zähne
- Micro-fresa SE 45, con collo lungo, 2 taglienti
- Micro-fraises SE 45 avec cou long, 2 dents
- 整体硬质合金 SE 45 系列 微小径2刀长颈平底铣刀

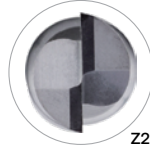
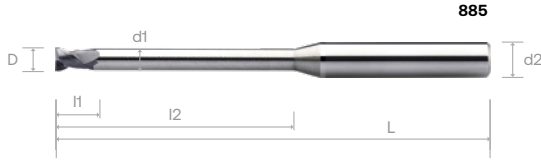

Order Number	Dimension (mm)						B0819	Order Number	Dimension (mm)						B0909
	D	l1	l2	L	d1	d2 (h6)			D	l1	l2	L	d1	d2 (h6)	
885 0100 050 0400 120	1	1.5	12	50	0.9	4	•	A03 0100 050 0400 120	1	1.5	12	50	0.9	4	•
885 0100 050 0400 140			14	50	0.9	4	•	A03 0100 050 0400 140			14	50	0.9	4	•
885 0100 050 0400 160			16	50	0.9	4	•	A03 0100 050 0400 160			16	50	0.9	4	•
885 0120 050 0400	1.2	1.8	-	50	-	4	•	A03 0120 050 0400	1.2	1.8	-	50	-	4	•
885 0120 050 0400 060			6	50	1.1	4	•	A03 0120 050 0400 060			6	50	1.1	4	•
885 0120 050 0400 080			8	50	1.1	4	•	A03 0120 050 0400 080			8	50	1.1	4	•
885 0120 050 0400 100			10	50	1.1	4	•	A03 0120 050 0400 100			10	50	1.1	4	•
885 0120 050 0400 120			12	50	1.1	4	•	A03 0120 050 0400 120			12	50	1.1	4	•
885 0140 050 0400	1.4	2.1	-	50	-	4	•	A03 0140 050 0400	1.4	2.1	-	50	-	4	•
885 0140 050 0400 060			6	50	1.3	4	•	A03 0140 050 0400 060			6	50	1.3	4	•
885 0140 050 0400 080			8	50	1.3	4	•	A03 0140 050 0400 080			8	50	1.3	4	•
885 0140 050 0400 100			10	50	1.3	4	•	A03 0140 050 0400 100			10	50	1.3	4	•
885 0140 050 0400 120			12	50	1.3	4	•	A03 0140 050 0400 120			12	50	1.3	4	•
885 0140 050 0400 140 *	14	50	1.3	4	•	A03 0140 050 0400 140 *	14	50	1.3	4	•				
885 0140 050 0400 160	16	50	1.3	4	•	A03 0140 050 0400 160	16	50	1.3	4	•				
885 0150 050 0400	1.5	2.3	-	50	-	4	•	A03 0150 050 0400	1.5	2.3	-	50	-	4	•
885 0150 050 0400 060			6	50	1.4	4	•	A03 0150 050 0400 060			6	50	1.4	4	•
885 0150 050 0400 080			8	50	1.4	4	•	A03 0150 050 0400 080			8	50	1.4	4	•
885 0150 050 0400 100			10	50	1.4	4	•	A03 0150 050 0400 100			10	50	1.4	4	•
885 0150 050 0400 120			12	50	1.4	4	•	A03 0150 050 0400 120			12	50	1.4	4	•
885 0150 050 0400 140	14	50	1.4	4	•	A03 0150 050 0400 140	14	50	1.4	4	•				
885 0150 050 0400 160 *	16	50	1.4	4	•	A03 0150 050 0400 160 *	16	50	1.4	4	•				
885 0150 060 0400	-	60	-	4	•	A03 0150 060 0400	-	60	-	4	•				
885 0150 060 0400 180	18	60	1.4	4	•	A03 0150 060 0400 180	18	60	1.4	4	•				
885 0150 060 0400 200	20	60	1.4	4	•	A03 0150 060 0400 200	20	60	1.4	4	•				
885 0160 050 0400	1.6	2.4	-	50	-	4	•	A03 0160 050 0400	1.6	2.4	-	50	-	4	•
885 0160 050 0400 060			6	50	1.5	4	•	A03 0160 050 0400 060			6	50	1.5	4	•
885 0160 050 0400 080			8	50	1.5	4	•	A03 0160 050 0400 080			8	50	1.5	4	•
885 0160 050 0400 100			10	50	1.5	4	•	A03 0160 050 0400 100			10	50	1.5	4	•
885 0160 050 0400 120			12	50	1.5	4	•	A03 0160 050 0400 120			12	50	1.5	4	•
885 0160 050 0400 140	14	50	1.5	4	•	A03 0160 050 0400 140	14	50	1.5	4	•				
885 0160 050 0400 160 *	16	50	1.5	4	•	A03 0160 050 0400 160 *	16	50	1.5	4	•				
885 0160 060 0400	-	60	-	4	•	A03 0160 060 0400	-	60	-	4	•				
885 0160 060 0400 180	18	60	1.5	4	•	A03 0160 060 0400 180	18	60	1.5	4	•				
885 0160 060 0400 200	20	60	1.5	4	•	A03 0160 060 0400 200	20	60	1.5	4	•				
885 0180 050 0400	1.8	2.7	-	50	-	4	•	A03 0180 050 0400	1.8	2.7	-	50	-	4	•
885 0180 050 0400 060			6	50	1.7	4	•	A03 0180 050 0400 060			6	50	1.7	4	•
885 0180 050 0400 080			8	50	1.7	4	•	A03 0180 050 0400 080			8	50	1.7	4	•
885 0180 050 0400 100			10	50	1.7	4	•	A03 0180 050 0400 100			10	50	1.7	4	•
885 0180 050 0400 120			12	50	1.7	4	•	A03 0180 050 0400 120			12	50	1.7	4	•
885 0180 050 0400 140	14	50	1.7	4	•	A03 0180 050 0400 140	14	50	1.7	4	•				
885 0180 050 0400 160 *	16	50	1.7	4	•	A03 0180 050 0400 160 *	16	50	1.7	4	•				
885 0180 060 0400	-	60	-	4	•	A03 0180 060 0400	-	60	-	4	•				
885 0180 060 0400 180	18	60	1.7	4	•	A03 0180 060 0400 180	18	60	1.7	4	•				
885 0180 060 0400 200	20	60	1.7	4	•	A03 0180 060 0400 200	20	60	1.7	4	•				

* - DIN 6535

cont'd ▶

Material Group | Material-Gruppe | Groupe Matiere | Gruppo Materiali | 材质主类

Cutting Parameter

N01	N02	N03	K01	K02	P01	P02	P03	M01	M02	S01	S02	S03	H01	H02	O01	O02	227 - 229
-----	-----	-----	-----	-----	-----	-----	-----	-----	-----	-----	-----	-----	-----	-----	-----	-----	-----------

SE 45 MINIATURE ENDMILLS WITH LONG NECK, 2 FLUTES

- VHM SE 45 Kleinstfräser mit langem Hals, 2 Zähne
- Micro-frese SE 45, con collo lungo, 2 taglienti
- Micro-fraises SE 45 avec cou long, 2 dents
- 整体硬质合金 SE 45 系列 微小径2刃长颈平底铣刀

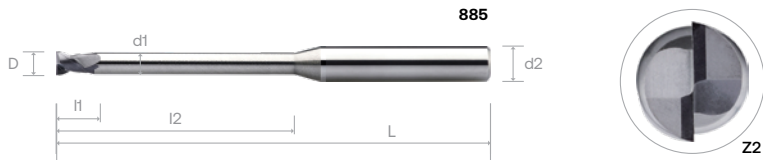
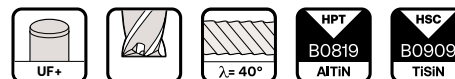

Order Number	Dimension (mm)						B0819	Order Number	Dimension (mm)						B0909
	D	I1	I2	L	d1	d2 (h6)			D	I1	I2	L	d1	d2 (h6)	
885 0200 050 0400	2	3	-	50	-	4	•	A03 0200 050 0400	2	3	-	50	-	4	◦
885 0200 050 0400 060			6	50	1.9	4	•	A03 0200 050 0400 060			6	50	1.9	4	•
885 0200 050 0400 080			8	50	1.9	4	•	A03 0200 050 0400 080			8	50	1.9	4	•
885 0200 050 0400 100			10	50	1.9	4	•	A03 0200 050 0400 100			10	50	1.9	4	•
885 0200 050 0400 120			12	50	1.9	4	•	A03 0200 050 0400 120			12	50	1.9	4	•
885 0200 050 0400 140			14	50	1.9	4	•	A03 0200 050 0400 140			14	50	1.9	4	•
885 0200 050 0400 160			16	50	1.9	4	•	A03 0200 050 0400 160			16	50	1.9	4	•
885 0200 060 0400			-	60	-	4	◦	A03 0200 060 0400			-	60	-	4	◦
885 0200 060 0400 180			18	60	1.9	4	•	A03 0200 060 0400 180			18	60	1.9	4	•
885 0200 060 0400 200			20	60	1.9	4	•	A03 0200 060 0400 200			20	60	1.9	4	•
885 0200 075 0400	-	75	-	4	◦	A03 0200 075 0400	-	75	-	4	◦				
885 0200 075 0400 250	25	75	1.9	4	•	A03 0200 075 0400 250	25	75	1.9	4	•				
885 0200 075 0400 300	30	75	1.9	4	•	A03 0200 075 0400 300	30	75	1.9	4	•				
885 0250 050 0400	2.5	3.7	-	50	-	4	◦	A03 0250 050 0400	2.5	3.7	-	50	-	4	◦
885 0250 050 0400 080			8	50	2.4	4	•	A03 0250 050 0400 080			8	50	2.4	4	•
885 0250 050 0400 100			10	50	2.4	4	•	A03 0250 050 0400 100			10	50	2.4	4	•
885 0250 050 0400 120			12	50	2.4	4	•	A03 0250 050 0400 120			12	50	2.4	4	•
885 0250 050 0400 140			14	50	2.4	4	•	A03 0250 050 0400 140			14	50	2.4	4	•
885 0250 050 0400 160			16	50	2.4	4	•	A03 0250 050 0400 160			16	50	2.4	4	•
885 0250 060 0400			-	60	-	4	◦	A03 0250 060 0400			-	60	-	4	◦
885 0250 060 0400 180			18	60	2.4	4	•	A03 0250 060 0400 180			18	60	2.4	4	•
885 0250 060 0400 200			20	60	2.4	4	•	A03 0250 060 0400 200			20	60	2.4	4	•
885 0250 060 0400 250			25	60	2.4	4	•	A03 0250 060 0400 250			25	60	2.4	4	•
885 0250 075 0400	-	75	-	4	◦	A03 0250 075 0400	-	75	-	4	◦				
885 0250 075 0400 300	30	75	2.4	4	•	A03 0250 075 0400 300	30	75	2.4	4	•				
885 0300 050 0600	3	4.5	-	50	-	6	◦	A03 0300 050 0600	3	4.5	-	50	-	6	◦
885 0300 050 0600 080 *			8	50	2.8	6	•	A03 0300 050 0600 080 *			8	50	2.8	6	•
885 0300 050 0600 100			10	50	2.8	6	•	A03 0300 050 0600 100			10	50	2.8	6	•
885 0300 050 0600 120			12	50	2.8	6	•	A03 0300 050 0600 120			12	50	2.8	6	•
885 0300 050 0600 140			14	50	2.8	6	•	A03 0300 050 0600 140			14	50	2.8	6	•
885 0300 060 0600			-	60	-	6	◦	A03 0300 060 0600			-	60	-	6	◦
885 0300 060 0600 160			16	60	2.8	6	•	A03 0300 060 0600 160			16	60	2.8	6	•
885 0300 060 0600 180 *			18	60	2.8	6	•	A03 0300 060 0600 180 *			18	60	2.8	6	•
885 0300 060 0600 200			20	60	2.8	6	•	A03 0300 060 0600 200			20	60	2.8	6	•
885 0300 075 0600			-	75	-	6	◦	A03 0300 075 0600			-	75	-	6	◦
885 0300 075 0600 250	25	75	2.8	6	•	A03 0300 075 0600 250	25	75	2.8	6	•				
885 0400 060 0600	4	4.5	-	60	-	6	◦	A03 0400 060 0600	4	4.5	-	60	-	6	◦
885 0400 060 0600 100			10	60	3.7	6	•	A03 0400 060 0600 100			10	60	3.7	6	•
885 0400 060 0600 150			15	60	3.7	6	•	A03 0400 060 0600 150			15	60	3.7	6	•
885 0400 060 0600 200			20	60	3.7	6	•	A03 0400 060 0600 200			20	60	3.7	6	•
885 0400 075 0600			-	75	-	6	◦	A03 0400 075 0600			-	75	-	6	◦
885 0400 075 0600 250			25	75	3.7	6	•	A03 0400 075 0600 250			25	75	3.7	6	•
885 0400 075 0600 300			30	75	3.7	6	•	A03 0400 075 0600 300			30	75	3.7	6	•
885 0400 075 0600 400			40	75	3.7	6	•	A03 0400 075 0600 400			40	75	3.7	6	•

* - DIN 6535

ALL LINE
EZ LINE -
ENDMILL
SE 30
NITICO 30
OPTIMUM
SE 45
SE 45X
NITICO 45
SE 60
SE 60X
DM70 -
SE 70
SE GR
TE 45
PLUNGE
-MILL
THREAD
MILL

Material Group | Material-Gruppe | Groupe Matière | Gruppo Materiali | 材质主类

Cutting Parameter

N01	N02	N03	K01	K02	P01	P02	P03	M01	M02	S01	S02	S03	H01	H02	O01	O02
-----	-----	-----	-----	-----	-----	-----	-----	-----	-----	-----	-----	-----	-----	-----	-----	-----

227-229



SE 45R MINIATURE TORUS ENDMILLS WITH LONG NECK, 2 FLUTES

- VHM SE 45R Toruskleinstfräser mit langem Hals, 2 Zähne
- Micro-frese toroidali SE 45, con collo lungo, 2 taglienti
- Micro-fraises SE 45 toriques avec cou long, 2 dents
- 整体硬质合金 SE 45R 系列 微小径2刃长颈平底铣刀



ALU LINE
EZ LINE - ENDMILL
SE 30
NITCo 30
OPTIMUM
SE 45
SE 45X
SE 45X
NITCo 45
SE 60
SE 60X
DM70 - SE70
SE GR
TE 45
PLUNGE - MILL
THREAD MILL

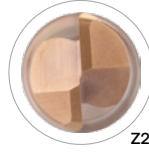

Order Number	Dimension (mm)								Order Number	Dimension (mm)							
	D	I1	I2	L	d1	d2(h6)	R	D		I1	I2	L	d1	d2(h6)	R		
B66 0020 050 0400 R005	0.2	0.3	-	50	-	4	0.05	◦	A79 0020 050 0400 R005	0.2	0.3	-	50	-	4	0.05	◦
B66 0020 050 0400 005 R005			0.5	50	0.17	4	0.05	◦	B66 0020 050 0400 005 R005			0.5	50	0.17	4	0.05	◦
B66 0020 050 0400 010 R005			1.0	50	0.17	4	0.05	◦	A79 0020 050 0400 010 R005			1.0	50	0.17	4	0.05	◦
B66 0020 050 0400 015 R005			1.5	50	0.17	4	0.05	◦	A79 0020 050 0400 015 R005			1.5	50	0.17	4	0.05	◦
B66 0020 050 0400 020 R005			2.0	50	0.17	4	0.05	◦	A79 0020 050 0400 020 R005			2.0	50	0.17	4	0.05	◦
B66 0030 050 0400 R005	0.3	0.4	-	50	-	4	0.05	◦	A79 0030 050 0400 R005	0.3	0.4	-	50	-	4	0.05	◦
B66 0030 050 0400 010 R005			1.0	50	0.27	4	0.05	◦	A79 0030 050 0400 010 R005			1.0	50	0.27	4	0.05	◦
B66 0030 050 0400 015 R005			1.5	50	0.27	4	0.05	◦	A79 0030 050 0400 015 R005			1.5	50	0.27	4	0.05	◦
B66 0030 050 0400 020 R005			2.0	50	0.27	4	0.05	◦	A79 0030 050 0400 020 R005			2.0	50	0.27	4	0.05	◦
B66 0030 050 0400 025 R005			2.5	50	0.27	4	0.05	◦	A79 0030 050 0400 025 R005			2.5	50	0.27	4	0.05	◦
B66 0030 050 0400 030 R005			3.0	50	0.27	4	0.05	◦	A79 0030 050 0400 030 R005			3.0	50	0.27	4	0.05	◦
B66 0030 050 0400 R010			-	50	-	4	0.1	◦	A79 0030 050 0400 R010			-	50	-	4	0.1	◦
B66 0030 050 0400 010 R010			1.0	50	0.27	4	0.1	◦	A79 0030 050 0400 010 R010			1.0	50	0.27	4	0.1	◦
B66 0030 050 0400 015 R010			1.5	50	0.27	4	0.1	◦	A79 0030 050 0400 015 R010			1.5	50	0.27	4	0.1	◦
B66 0030 050 0400 020 R010			2.0	50	0.27	4	0.1	◦	A79 0030 050 0400 020 R010			2.0	50	0.27	4	0.1	◦
B66 0030 050 0400 025 R010	2.5	50	0.27	4	0.1	◦	A79 0030 050 0400 025 R010	2.5	50	0.27	4	0.1	◦				
B66 0030 050 0400 030 R010	3.0	50	0.27	4	0.1	◦	A79 0030 050 0400 030 R010	3.0	50	0.27	4	0.1	◦				
B66 0040 050 0400 R005	0.4	0.6	-	50	-	4	0.05	◦	A79 0040 050 0400 R005	0.4	0.6	-	50	-	4	0.05	◦
B66 0040 050 0400 010 R005			1.0	50	0.37	4	0.05	◦	A79 0040 050 0400 010 R005			1.0	50	0.37	4	0.05	◦
B66 0040 050 0400 015 R005			1.5	50	0.37	4	0.05	◦	A79 0040 050 0400 015 R005			1.5	50	0.37	4	0.05	◦
B66 0040 050 0400 020 R005			2.0	50	0.37	4	0.05	◦	A79 0040 050 0400 020 R005			2.0	50	0.37	4	0.05	◦
B66 0040 050 0400 025 R005			2.5	50	0.37	4	0.05	◦	A79 0040 050 0400 025 R005			2.5	50	0.37	4	0.05	◦
B66 0040 050 0400 030 R005			3.0	50	0.37	4	0.05	◦	A79 0040 050 0400 030 R005			3.0	50	0.37	4	0.05	◦
B66 0040 050 0400 035 R005			3.5	50	0.37	4	0.05	◦	A79 0040 050 0400 035 R005			3.5	50	0.37	4	0.05	◦
B66 0040 050 0400 040 R005			4.0	50	0.37	4	0.05	◦	A79 0040 050 0400 040 R005			4.0	50	0.37	4	0.05	◦
B66 0040 050 0400 R010			-	50	-	4	0.1	◦	A79 0040 050 0400 R010			-	50	-	4	0.1	◦
B66 0040 050 0400 010 R010			1.0	50	0.37	4	0.1	◦	A79 0040 050 0400 010 R010			1.0	50	0.37	4	0.1	◦
B66 0040 050 0400 015 R010	1.5	50	0.37	4	0.1	◦	A79 0040 050 0400 015 R010	1.5	50	0.37	4	0.1	◦				
B66 0040 050 0400 020 R010	2.0	50	0.37	4	0.1	◦	A79 0040 050 0400 020 R010	2.0	50	0.37	4	0.1	◦				
B66 0040 050 0400 025 R010	2.5	50	0.37	4	0.1	◦	A79 0040 050 0400 025 R010	2.5	50	0.37	4	0.1	◦				
B66 0040 050 0400 030 R010	3.0	50	0.37	4	0.1	◦	A79 0040 050 0400 030 R010	3.0	50	0.37	4	0.1	◦				
B66 0040 050 0400 035 R010	3.5	50	0.37	4	0.1	◦	A79 0040 050 0400 035 R010	3.5	50	0.37	4	0.1	◦				
B66 0040 050 0400 040 R010	4.0	50	0.37	4	0.1	◦	A79 0040 050 0400 040 R010	4.0	50	0.37	4	0.1	◦				
B66 0050 050 0400 R005	0.5	0.7	-	50	-	4	0.05	◦	A79 0050 050 0400 R005	0.5	0.7	-	50	-	4	0.05	◦
B66 0050 050 0400 020 R005			2.0	50	0.45	4	0.05	◦	A79 0050 050 0400 020 R005			2.0	50	0.45	4	0.05	◦
B66 0050 050 0400 040 R005			4.0	50	0.45	4	0.05	◦	A79 0050 050 0400 040 R005			4.0	50	0.45	4	0.05	◦
B66 0050 050 0400 060 R005			6.0	50	0.45	4	0.05	◦	A79 0050 050 0400 060 R005			6.0	50	0.45	4	0.05	◦
B66 0050 050 0400 080 R005			8.0	50	0.45	4	0.05	◦	A79 0050 050 0400 080 R005			8.0	50	0.45	4	0.05	◦
B66 0050 050 0400 R010			-	50	-	4	0.1	◦	A79 0050 050 0400 R010			-	50	-	4	0.1	◦
B66 0050 050 0400 020 R010			2.0	50	0.45	4	0.1	◦	A79 0050 050 0400 020 R010			2.0	50	0.45	4	0.1	◦
B66 0050 050 0400 040 R010			4.0	50	0.45	4	0.1	◦	A79 0050 050 0400 040 R010			4.0	50	0.45	4	0.1	◦
B66 0050 050 0400 060 R010			6.0	50	0.45	4	0.1	◦	A79 0050 050 0400 060 R010			6.0	50	0.45	4	0.1	◦
B66 0050 050 0400 080 R010			8.0	50	0.45	4	0.1	◦	A79 0050 050 0400 080 R010			8.0	50	0.45	4	0.1	◦
B66 0060 050 0400 R010	0.6	0.9	-	50	-	4	0.1	◦	A79 0060 050 0400 R010	0.6	0.9	-	50	-	4	0.1	◦
B66 0060 050 0400 020 R010			2.0	50	0.55	4	0.1	◦	A79 0060 050 0400 020 R010			2.0	50	0.55	4	0.1	◦
B66 0060 050 0400 040 R010			4.0	50	0.55	4	0.1	◦	A79 0060 050 0400 040 R010			4.0	50	0.55	4	0.1	◦
B66 0060 050 0400 060 R010			6.0	50	0.55	4	0.1	◦	A79 0060 050 0400 060 R010			6.0	50	0.55	4	0.1	◦
B66 0060 050 0400 080 R010			8.0	50	0.55	4	0.1	◦	A79 0060 050 0400 080 R010			8.0	50	0.55	4	0.1	◦
B66 0060 050 0400 100 R010	10.0	50	0.55	4	0.1	◦	A79 0060 050 0400 100 R010	10.0	50	0.55	4	0.1	◦				
B66 0070 050 0400 R010	0.7	1.0	-	50	-	4	0.1	◦	A79 0070 050 0400 R010	0.7	1.0	-	50	-	4	0.1	◦
B66 0070 050 0400 020 R010			2.0	50	0.65	4	0.1	◦	A79 0070 050 0400 020 R010			2.0	50	0.65	4	0.1	◦
B66 0070 050 0400 040 R010			4.0	50	0.65	4	0.1	◦	A79 0070 050 0400 040 R010			4.0	50	0.65	4	0.1	◦
B66 0070 050 0400 060 R010			6.0	50	0.65	4	0.1	◦	A79 0070 050 0400 060 R010			6.0	50	0.65	4	0.1	◦
B66 0070 050 0400 080 R010			8.0	50	0.65	4	0.1	◦	A79 0070 050 0400 080 R010			8.0	50	0.65	4	0.1	◦
B66 0070 050 0400 100 R010	10.0	50	0.65	4	0.1	◦	A79 0070 050 0400 100 R010	10.0	50	0.65	4	0.1	◦				

cont'd ►

D mm	Tol. µm
0.1 - 0.7	0 / -12
0.7 - 4.0	0 / -20

Material Group | Material-Gruppe | Groupe Matière | Gruppo Materiali | 材质主类

Cutting Parameter

N01	N02	N03	K01	K02	P01	P02	P03	M01	M02	S01	S02	S03	H01	H02	O01	O02	227 - 229
-----	-----	-----	-----	-----	-----	-----	-----	-----	-----	-----	-----	-----	-----	-----	-----	-----	-----------

SE 45R MINIATURE TORUS ENDMILLS WITH LONG NECK, 2 FLUTES

- VHM SE 45R Toruskleinstfräser mit langem Hals, 2 Zähne
- Micro-frese toroidali SE 45, con collo lungo, 2 taglienti
- Micro-fraises SE 45 toriques avec cou long, 2 dents
- 整体硬质合金 SE 45R 系列 微小径2刀长颈平底铣刀

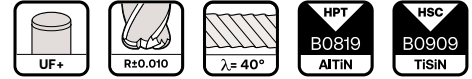

Order Number	Dimension (mm)							B0819	Order Number	Dimension (mm)							B0909					
	D	l1	l2	L	d1	d2(f6)	R			D	l1	l2	L	d1	d2(f6)	R						
B66 0080 050 0400 R005	0.8	1.2	-	50	-	4	0.05	°	A79 0080 050 0400 R005	0.8	1.2	-	50	-	4	0.05	°	A79 0080 050 0400 R005				
B66 0080 050 0400 040 R005			4.0	50	0.75	4	0.05	°	A79 0080 050 0400 040 R005			4.0	50	0.75	4	0.05	°	A79 0080 050 0400 040 R005				
B66 0080 050 0400 060 R005			6.0	50	0.75	4	0.05	°	A79 0080 050 0400 060 R005			6.0	50	0.75	4	0.05	°	A79 0080 050 0400 060 R005				
B66 0080 050 0400 080 R005			8.0	50	0.75	4	0.05	°	A79 0080 050 0400 080 R005			8.0	50	0.75	4	0.05	°	A79 0080 050 0400 080 R005				
B66 0080 050 0400 100 R005			10.0	50	0.75	4	0.05	°	A79 0080 050 0400 100 R005			10.0	50	0.75	4	0.05	°	A79 0080 050 0400 100 R005				
B66 0080 050 0400 120 R005			12.0	50	0.75	4	0.05	°	A79 0080 050 0400 120 R005			12.0	50	0.75	4	0.05	°	A79 0080 050 0400 120 R005				
B66 0080 050 0400 R010			-	50	-	4	0.1	°	A79 0080 050 0400 R010			-	50	-	4	0.1	°	A79 0080 050 0400 R010				
B66 0080 050 0400 040 R010			4.0	50	0.75	4	0.1	°	A79 0080 050 0400 040 R010			4.0	50	0.75	4	0.1	°	A79 0080 050 0400 040 R010				
B66 0080 050 0400 060 R010			6.0	50	0.75	4	0.1	°	A79 0080 050 0400 060 R010			6.0	50	0.75	4	0.1	°	A79 0080 050 0400 060 R010				
B66 0080 050 0400 080 R010			8.0	50	0.75	4	0.1	°	A79 0080 050 0400 080 R010			8.0	50	0.75	4	0.1	°	A79 0080 050 0400 080 R010				
B66 0080 050 0400 100 R010			10.0	50	0.75	4	0.1	°	A79 0080 050 0400 100 R010			10.0	50	0.75	4	0.1	°	A79 0080 050 0400 100 R010				
B66 0080 050 0400 120 R010			12.0	50	0.75	4	0.1	°	A79 0080 050 0400 120 R010			12.0	50	0.75	4	0.1	°	A79 0080 050 0400 120 R010				
B66 0090 050 0400 R010			0.9	1.4	-	50	-	4	0.1			°	A79 0090 050 0400 R010	0.9	1.4	-	50	-	4	0.1	°	A79 0090 050 0400 R010
B66 0090 050 0400 060 R010					6.0	50	0.85	4	0.1			°	A79 0090 050 0400 060 R010			6.0	50	0.85	4	0.1	°	A79 0090 050 0400 060 R010
B66 0090 050 0400 080 R010					8.0	50	0.85	4	0.1			°	A79 0090 050 0400 080 R010			8.0	50	0.85	4	0.1	°	A79 0090 050 0400 080 R010
B66 0090 050 0400 100 R010					10.0	50	0.85	4	0.1			°	A79 0090 050 0400 100 R010			10.0	50	0.85	4	0.1	°	A79 0090 050 0400 100 R010
B66 0090 050 0400 150 R010	15.0	50			0.85	4	0.1	°	A79 0090 050 0400 150 R010	15.0	50	0.85	4			0.1	°	A79 0090 050 0400 150 R010				
B66 0100 050 0400 R010	-	50			-	4	0.1	°	A79 0100 050 0400 R010	-	50	-	4			0.1	°	A79 0100 050 0400 R010				
B66 0100 050 0400 040 R010	4.0	50			0.9	4	0.1	°	A79 0100 050 0400 040 R010	4.0	50	0.9	4			0.1	°	A79 0100 050 0400 040 R010				
B66 0100 050 0400 060 R010	6.0	50			0.9	4	0.1	°	A79 0100 050 0400 060 R010	6.0	50	0.9	4			0.1	°	A79 0100 050 0400 060 R010				
B66 0100 050 0400 080 R010	8.0	50			0.9	4	0.1	°	A79 0100 050 0400 080 R010	8.0	50	0.9	4			0.1	°	A79 0100 050 0400 080 R010				
B66 0100 050 0400 100 R010	10.0	50			0.9	4	0.1	°	A79 0100 050 0400 100 R010	10.0	50	0.9	4			0.1	°	A79 0100 050 0400 100 R010				
B66 0100 050 0400 120 R010	12.0	50			0.9	4	0.1	°	A79 0100 050 0400 120 R010	12.0	50	0.9	4			0.1	°	A79 0100 050 0400 120 R010				
B66 0100 050 0400 140 R010	14.0	50			0.9	4	0.1	°	A79 0100 050 0400 140 R010	14.0	50	0.9	4			0.1	°	A79 0100 050 0400 140 R010				
B66 0100 050 0400 160 R010 *	16.0	50			0.9	4	0.1	°	A79 0100 050 0400 160 R010 *	16.0	50	0.9	4			0.1	°	A79 0100 050 0400 160 R010 *				
B66 0100 060 0400 R010	-	60			-	4	0.1	°	A79 0100 060 0400 R010	-	60	-	4			0.1	°	A79 0100 060 0400 R010				
B66 0100 060 0400 200 R010	20.0	60			0.9	4	0.1	°	A79 0100 060 0400 200 R010	20.0	60	0.9	4			0.1	°	A79 0100 060 0400 200 R010				
B66 0100 050 0400 R020	-	50			-	4	0.2	°	A79 0100 050 0400 R020	-	50	-	4			0.2	°	A79 0100 050 0400 R020				
B66 0100 050 0400 040 R020	4.0	50	0.9	4	0.2	°	A79 0100 050 0400 040 R020	4.0	50	0.9	4	0.2	°	A79 0100 050 0400 040 R020								
B66 0100 050 0400 060 R020	6.0	50	0.9	4	0.2	°	A79 0100 050 0400 060 R020	6.0	50	0.9	4	0.2	°	A79 0100 050 0400 060 R020								
B66 0100 050 0400 080 R020	8.0	50	0.9	4	0.2	°	A79 0100 050 0400 080 R020	8.0	50	0.9	4	0.2	°	A79 0100 050 0400 080 R020								
B66 0100 050 0400 100 R020	10.0	50	0.9	4	0.2	°	A79 0100 050 0400 100 R020	10.0	50	0.9	4	0.2	°	A79 0100 050 0400 100 R020								
B66 0100 050 0400 120 R020	12.0	50	0.9	4	0.2	°	A79 0100 050 0400 120 R020	12.0	50	0.9	4	0.2	°	A79 0100 050 0400 120 R020								
B66 0100 050 0400 140 R020	14.0	50	0.9	4	0.2	°	A79 0100 050 0400 140 R020	14.0	50	0.9	4	0.2	°	A79 0100 050 0400 140 R020								
B66 0100 050 0400 160 R020 *	16.0	50	0.9	4	0.2	°	A79 0100 050 0400 160 R020 *	16.0	50	0.9	4	0.2	°	A79 0100 050 0400 160 R020 *								
B66 0100 060 0400 R020	-	50	-	4	0.2	°	A79 0100 060 0400 R020	-	50	-	4	0.2	°	A79 0100 060 0400 R020								
B66 0100 060 0400 200 R020	20.0	50	0.9	4	0.2	°	A79 0100 060 0400 200 R020	20.0	50	0.9	4	0.2	°	A79 0100 060 0400 200 R020								
B66 0100 050 0400 R030	-	50	-	4	0.3	°	A79 0100 050 0400 R030	-	50	-	4	0.3	°	A79 0100 050 0400 R030								
B66 0100 050 0400 060 R030	6.0	50	0.9	4	0.3	°	A79 0100 050 0400 060 R030	6.0	50	0.9	4	0.3	°	A79 0100 050 0400 060 R030								
B66 0100 050 0400 100 R030	10.0	50	0.9	4	0.3	°	A79 0100 050 0400 100 R030	10.0	50	0.9	4	0.3	°	A79 0100 050 0400 100 R030								
B66 0100 050 0400 160 R030 *	16.0	50	0.9	4	0.3	°	A79 0100 050 0400 160 R030 *	16.0	50	0.9	4	0.3	°	A79 0100 050 0400 160 R030 *								
B66 0100 060 0400 R030	-	60	-	4	0.3	°	A79 0100 060 0400 R030	-	60	-	4	0.3	°	A79 0100 060 0400 R030								
B66 0100 060 0400 200 R030	20.0	60	0.9	4	0.3	°	A79 0100 060 0400 200 R030	20.0	60	0.9	4	0.3	°	A79 0100 060 0400 200 R030								
B66 0120 050 0400 R010	1.2	1.8	-	50	-	4	0.1	°	A79 0120 050 0400 R010	1.2	1.8	-	50	-	4	0.1	°	A79 0120 050 0400 R010				
B66 0120 050 0400 060 R010			6.0	50	1.1	4	0.1	°	A79 0120 050 0400 060 R010			6.0	50	1.1	4	0.1	°	A79 0120 050 0400 060 R010				
B66 0120 050 0400 080 R010			8.0	50	1.1	4	0.1	°	A79 0120 050 0400 080 R010			8.0	50	1.1	4	0.1	°	A79 0120 050 0400 080 R010				
B66 0120 050 0400 100 R010			10.0	50	1.1	4	0.1	°	A79 0120 050 0400 100 R010			10.0	50	1.1	4	0.1	°	A79 0120 050 0400 100 R010				
B66 0120 050 0400 120 R010	12.0	50	1.1	4	0.1	°	A79 0120 050 0400 120 R010	12.0	50	1.1	4	0.1	°	A79 0120 050 0400 120 R010								
B66 0140 050 0400 R010	1.4	2.1	-	50	-	4	0.1	°	A79 0140 050 0400 R010	1.4	2.1	-	50	-	4	0.1	°	A79 0140 050 0400 R010				
B66 0140 050 0400 060 R010			6.0	50	1.3	4	0.1	°	A79 0140 050 0400 060 R010			6.0	50	1.3	4	0.1	°	A79 0140 050 0400 060 R010				
B66 0140 050 0400 080 R010			8.0	50	1.3	4	0.1	°	A79 0140 050 0400 080 R010			8.0	50	1.3	4	0.1	°	A79 0140 050 0400 080 R010				
B66 0140 050 0400 100 R010			10.0	50	1.3	4	0.1	°	A79 0140 050 0400 100 R010			10.0	50	1.3	4	0.1	°	A79 0140 050 0400 100 R010				
B66 0140 050 0400 120 R010	12.0	50	1.3	4	0.1	°	A79 0140 050 0400 120 R010	12.0	50	1.3	4	0.1	°	A79 0140 050 0400 120 R010								
B66 0140 050 0400 140 R010	14.0	50	1.3	4	0.1	°	A79 0140 050 0400 140 R010	14.0	50	1.3	4	0.1	°	A79 0140 050 0400 140 R010								
B66 0140 050 0400 160 R010 *	16.0	50	1.3	4	0.1	°	A79 0140 050 0400 160 R010 *	16.0	50	1.3	4	0.1	°	A79 0140 050 0400 160 R010 *								

* - DIN 6535

cont'd ▶

D mm	Tol. μm
0.1 ~ 0.7	0 / -12
0.7 ~ 4.0	0 / -20

Material Group | Material-Gruppe | Groupe Matière | Gruppo Materiali | 材质主类

Cutting Parameter

N01	N02	N03	K01	K02	P01	P02	P03	M01	M02	S01	S02	S03	H01	H02	O01	O02	227 - 229
-----	-----	-----	-----	-----	-----	-----	-----	-----	-----	-----	-----	-----	-----	-----	-----	-----	-----------

SE 45R MINIATURE TORUS ENDMILLS WITH LONG NECK, 2 FLUTES

- VHM SE 45R Toruskleinstfräser mit langem Hals, 2 Zähne
- Micro-frese toroidali SE 45, con collo lungo, 2 taglianti
- Micro-fraises SE 45 toriques avec cou long, 2 dents
- 整体硬质合金 SE 45R 系列 微小径2刃长颈平底铣刀



Order Number	Dimension (mm)							B0819	Order Number	Dimension (mm)							B0909	
	D	I1	I2	L	d1	d2(h6)	R			D	I1	I2	L	d1	d2(h6)	R		
B66 0150 050 0400 R010	1.5	2.3	-	50	-	4	0.1	°	A79 0150 050 0400 R010	1.5	2.3	-	50	-	4	0.1	°	A79 0150 050 0400 R010
B66 0150 050 0400 060 R010			6.0	50	1.4	4	0.1	°	A79 0150 050 0400 060 R010			6.0	50	1.4	4	0.1	°	A79 0150 050 0400 060 R010
B66 0150 050 0400 080 R010			8.0	50	1.4	4	0.1	°	A79 0150 050 0400 080 R010			8.0	50	1.4	4	0.1	°	A79 0150 050 0400 080 R010
B66 0150 050 0400 120 R010			12.0	50	1.4	4	0.1	°	A79 0150 050 0400 120 R010			12.0	50	1.4	4	0.1	°	A79 0150 050 0400 120 R010
B66 0150 050 0400 160 R010 *			16.0	50	1.4	4	0.1	°	A79 0150 050 0400 160 R010 *			16.0	50	1.4	4	0.1	°	A79 0150 050 0400 160 R010 *
B66 0150 060 0400 R010			-	60	-	4	0.1	°	A79 0150 060 0400 R010			-	60	-	4	0.1	°	A79 0150 060 0400 R010
B66 0150 060 0400 200 R010			20.0	60	1.4	4	0.1	°	A79 0150 060 0400 200 R010			20.0	60	1.4	4	0.1	°	A79 0150 060 0400 200 R010
B66 0150 050 0400 R020			-	50	-	4	0.2	°	A79 0150 050 0400 R020			-	50	-	4	0.2	°	A79 0150 050 0400 R020
B66 0150 050 0400 060 R020			6.0	50	1.4	4	0.2	°	A79 0150 050 0400 060 R020			6.0	50	1.4	4	0.2	°	A79 0150 050 0400 060 R020
B66 0150 050 0400 080 R020			8.0	50	1.4	4	0.2	°	A79 0150 050 0400 080 R020			8.0	50	1.4	4	0.2	°	A79 0150 050 0400 080 R020
B66 0150 050 0400 100 R020			10.0	50	1.4	4	0.2	°	A79 0150 050 0400 100 R020			10.0	50	1.4	4	0.2	°	A79 0150 050 0400 100 R020
B66 0150 050 0400 120 R020			12.0	50	1.4	4	0.2	°	A79 0150 050 0400 120 R020			12.0	50	1.4	4	0.2	°	A79 0150 050 0400 120 R020
B66 0150 050 0400 140 R020			14.0	50	1.4	4	0.2	°	A79 0150 050 0400 140 R020			14.0	50	1.4	4	0.2	°	A79 0150 050 0400 140 R020
B66 0150 050 0400 160 R020 *			16.0	50	1.4	4	0.2	°	A79 0150 050 0400 160 R020 *			16.0	50	1.4	4	0.2	°	A79 0150 050 0400 160 R020 *
B66 0150 060 0400 R020			-	60	-	4	0.2	°	A79 0150 060 0400 R020			-	60	-	4	0.2	°	A79 0150 060 0400 R020
B66 0150 060 0400 180 R020			18.0	60	1.4	4	0.2	°	A79 0150 060 0400 180 R020			18.0	60	1.4	4	0.2	°	A79 0150 060 0400 180 R020
B66 0150 060 0400 200 R020			20.0	60	1.4	4	0.2	°	A79 0150 060 0400 200 R020			20.0	60	1.4	4	0.2	°	A79 0150 060 0400 200 R020
B66 0150 050 0400 R030			-	50	-	4	0.3	°	A79 0150 050 0400 R030			-	50	-	4	0.3	°	A79 0150 050 0400 R030
B66 0150 050 0400 080 R030			8.0	50	1.4	4	0.3	°	A79 0150 050 0400 080 R030			8.0	50	1.4	4	0.3	°	A79 0150 050 0400 080 R030
B66 0150 050 0400 160 R030 *			16.0	50	1.4	4	0.3	°	A79 0150 050 0400 160 R030 *			16.0	50	1.4	4	0.3	°	A79 0150 050 0400 160 R030 *
B66 0150 060 0400 R030			-	60	-	4	0.3	°	A79 0150 060 0400 R030			-	60	-	4	0.3	°	A79 0150 060 0400 R030
B66 0150 060 0400 200 R030			20.0	60	1.4	4	0.3	°	A79 0150 060 0400 200 R030			20.0	60	1.4	4	0.3	°	A79 0150 060 0400 200 R030
B66 0160 050 0400 R010			-	50	-	4	0.1	°	A79 0160 050 0400 R010			-	50	-	4	0.1	°	A79 0160 050 0400 R010
B66 0160 050 0400 060 R010			6.0	50	1.5	4	0.1	°	A79 0160 050 0400 060 R010			6.0	50	1.5	4	0.1	°	A79 0160 050 0400 060 R010
B66 0160 050 0400 080 R010	8.0	50	1.5	4	0.1	°	A79 0160 050 0400 080 R010	8.0	50	1.5	4	0.1	°	A79 0160 050 0400 080 R010				
B66 0160 050 0400 100 R010	10.0	50	1.5	4	0.1	°	A79 0160 050 0400 100 R010	10.0	50	1.5	4	0.1	°	A79 0160 050 0400 100 R010				
B66 0160 050 0400 120 R010	12.0	50	1.5	4	0.1	°	A79 0160 050 0400 120 R010	12.0	50	1.5	4	0.1	°	A79 0160 050 0400 120 R010				
B66 0160 050 0400 140 R010	14.0	50	1.5	4	0.1	°	A79 0160 050 0400 140 R010	14.0	50	1.5	4	0.1	°	A79 0160 050 0400 140 R010				
B66 0160 050 0400 160 R010 *	16.0	50	1.5	4	0.1	°	A79 0160 050 0400 160 R010 *	16.0	50	1.5	4	0.1	°	A79 0160 050 0400 160 R010 *				
B66 0160 060 0400 R010	-	60	-	4	0.1	°	A79 0160 060 0400 R010	-	60	-	4	0.1	°	A79 0160 060 0400 R010				
B66 0160 060 0400 180 R010	18.0	60	1.5	4	0.1	°	A79 0160 060 0400 180 R010	18.0	60	1.5	4	0.1	°	A79 0160 060 0400 180 R010				
B66 0160 060 0400 200 R010	20.0	60	1.5	4	0.1	°	A79 0160 060 0400 200 R010	20.0	60	1.5	4	0.1	°	A79 0160 060 0400 200 R010				
B66 0180 050 0400 R020	-	50	-	4	0.2	°	A79 0180 050 0400 R020	-	50	-	4	0.2	°	A79 0180 050 0400 R020				
B66 0180 050 0400 060 R020	6.0	50	1.7	4	0.2	°	A79 0180 050 0400 060 R020	6.0	50	1.7	4	0.2	°	A79 0180 050 0400 060 R020				
B66 0180 050 0400 080 R020	8.0	50	1.7	4	0.2	°	A79 0180 050 0400 080 R020	8.0	50	1.7	4	0.2	°	A79 0180 050 0400 080 R020				
B66 0180 050 0400 100 R020	10.0	50	1.7	4	0.2	°	A79 0180 050 0400 100 R020	10.0	50	1.7	4	0.2	°	A79 0180 050 0400 100 R020				
B66 0180 050 0400 120 R020	12.0	50	1.7	4	0.2	°	A79 0180 050 0400 120 R020	12.0	50	1.7	4	0.2	°	A79 0180 050 0400 120 R020				
B66 0180 050 0400 140 R020	14.0	50	1.7	4	0.2	°	A79 0180 050 0400 140 R020	14.0	50	1.7	4	0.2	°	A79 0180 050 0400 140 R020				
B66 0180 050 0400 160 R020 *	16.0	50	1.7	4	0.2	°	A79 0180 050 0400 160 R020 *	16.0	50	1.7	4	0.2	°	A79 0180 050 0400 160 R020 *				
B66 0180 060 0400 R020	-	60	-	4	0.2	°	A79 0180 060 0400 R020	-	60	-	4	0.2	°	A79 0180 060 0400 R020				
B66 0180 060 0400 180 R020	18.0	60	1.7	4	0.2	°	A79 0180 060 0400 180 R020	18.0	60	1.7	4	0.2	°	A79 0180 060 0400 180 R020				
B66 0180 060 0400 200 R020	20.0	60	1.7	4	0.2	°	A79 0180 060 0400 200 R020	20.0	60	1.7	4	0.2	°	A79 0180 060 0400 200 R020				
B66 0200 050 0400 R020	-	50	-	4	0.2	°	A79 0200 050 0400 R020	-	50	-	4	0.2	°	A79 0200 050 0400 R020				
B66 0200 050 0400 060 R020	6.0	50	1.9	4	0.2	°	A79 0200 050 0400 060 R020	6.0	50	1.9	4	0.2	°	A79 0200 050 0400 060 R020				
B66 0200 050 0400 080 R020	8.0	50	1.9	4	0.2	°	A79 0200 050 0400 080 R020	8.0	50	1.9	4	0.2	°	A79 0200 050 0400 080 R020				
B66 0200 050 0400 100 R020	10.0	50	1.9	4	0.2	°	A79 0200 050 0400 100 R020	10.0	50	1.9	4	0.2	°	A79 0200 050 0400 100 R020				
B66 0200 050 0400 120 R020	12.0	50	1.9	4	0.2	°	A79 0200 050 0400 120 R020	12.0	50	1.9	4	0.2	°	A79 0200 050 0400 120 R020				
B66 0200 050 0400 140 R020	14.0	50	1.9	4	0.2	°	A79 0200 050 0400 140 R020	14.0	50	1.9	4	0.2	°	A79 0200 050 0400 140 R020				
B66 0200 050 0400 160 R020	16.0	50	1.9	4	0.2	°	A79 0200 050 0400 160 R020	16.0	50	1.9	4	0.2	°	A79 0200 050 0400 160 R020				
B66 0200 060 0400 R020	-	60	-	4	0.2	°	A79 0200 060 0400 R020	-	60	-	4	0.2	°	A79 0200 060 0400 R020				
B66 0200 060 0400 180 R020	18.0	60	1.9	4	0.2	°	A79 0200 060 0400 180 R020	18.0	60	1.9	4	0.2	°	A79 0200 060 0400 180 R020				
B66 0200 060 0400 200 R020	20.0	60	1.9	4	0.2	°	A79 0200 060 0400 200 R020	20.0	60	1.9	4	0.2	°	A79 0200 060 0400 200 R020				
B66 0200 075 0400 R020	-	75	-	4	0.2	°	A79 0200 075 0400 R020	-	75	-	4	0.2	°	A79 0200 075 0400 R020				
B66 0200 075 0400 250 R020	25.0	75	1.9	4	0.2	°	A79 0200 075 0400 250 R020	25.0	75	1.9	4	0.2	°	A79 0200 075 0400 250 R020				
B66 0200 075 0400 300 R020	30.0	75	1.9	4	0.2	°	A79 0200 075 0400 300 R020	30.0	75	1.9	4	0.2	°	A79 0200 075 0400 300 R020				

* - DIN 6535

cont'd ▶

D mm	Tol. μm
0.1 - 0.7	0 / -12
0.7 - 4.0	0 / -20

Material Group | Material-Gruppe | Groupe Matière | Gruppo Materiali | 材质主类

Cutting Parameter

N01	N02	N03	K01	K02	P01	P02	P03	M01	M02	S01	S02	S03	H01	H02	O01	O02	227 - 229
-----	-----	-----	-----	-----	-----	-----	-----	-----	-----	-----	-----	-----	-----	-----	-----	-----	-----------

SE 45R MINIATURE TORUS ENDMILLS WITH LONG NECK, 2 FLUTES

- VHM SE 45R Toruskleinstfräser mit langem Hals, 2 Zähne
- Micro-frese toroidali SE 45, con collo lungo, 2 taglienti
- Micro-fraises SE 45 toriques avec cou long, 2 dents
- 整体硬质合金 SE 45R 系列 微小径2刃长颈平底铣刀

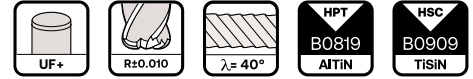

Order Number	Dimension (mm)							B0819	Order Number	Dimension (mm)							B0909
	D	I1	I2	L	d1	d2(f6)	R			D	I1	I2	L	d1	d2(f6)	R	
B66 0200 050 0400 R030	2	3	-	50	-	4	0.3	°	A79 0200 050 0400 R030	2	3	-	50	-	4	0.3	°
B66 0200 050 0400 080 R030			8.0	50	1.9	4	0.3	°	A79 0200 050 0400 080 R030			8.0	50	1.9	4	0.3	°
B66 0200 050 0400 160 R030			16.0	50	1.9	4	0.3	°	A79 0200 050 0400 160 R030			16.0	50	1.9	4	0.3	°
B66 0200 060 0400 R030			-	60	-	4	0.3	°	A79 0200 060 0400 R030			-	60	-	4	0.3	°
B66 0200 060 0400 200 R030			20.0	60	1.9	4	0.3	•	A79 0200 060 0400 200 R030			20.0	60	1.9	4	0.3	°
B66 0200 050 0400 R050			-	50	-	4	0.5	°	A79 0200 050 0400 R050			-	50	-	4	0.5	°
B66 0200 050 0400 060 R050			6.0	50	1.9	4	0.5	°	A79 0200 050 0400 060 R050			6.0	50	1.9	4	0.5	°
B66 0200 050 0400 080 R050			8.0	50	1.9	4	0.5	°	A79 0200 050 0400 080 R050			8.0	50	1.9	4	0.5	•
B66 0200 050 0400 120 R050			12.0	50	1.9	4	0.5	°	A79 0200 050 0400 120 R050			12.0	50	1.9	4	0.5	•
B66 0200 050 0400 160 R050			16.0	50	1.9	4	0.5	°	A79 0200 050 0400 160 R050			16.0	50	1.9	4	0.5	•
B66 0200 060 0400 R050			-	60	-	4	0.5	°	A79 0200 060 0400 R050			-	60	-	4	0.5	°
B66 0200 060 0400 200 R050			20.0	60	1.9	4	0.5	•	A79 0200 060 0400 200 R050			20.0	60	1.9	4	0.5	•
B66 0200 075 0400 R050			-	75	-	4	0.5	°	A79 0200 075 0400 R050			-	75	-	4	0.5	°
B66 0200 075 0400 250 R050			25.0	75	1.9	4	0.5	°	A79 0200 075 0400 250 R050			25.0	75	1.9	4	0.5	•
B66 0200 075 0400 300 R050			30.0	75	1.9	4	0.5	°	A79 0200 075 0400 300 R050			30.0	75	1.9	4	0.5	°
B66 0250 050 0400 R030			2.5	3.7	-	50	-	4	0.3			°	A79 0250 050 0400 R030	2.5	3.7	-	50
B66 0250 050 0400 080 R030	8.0	50			2.4	4	0.3	°	A79 0250 050 0400 080 R030	8.0	50	2.4	4			0.3	•
B66 0250 050 0400 100 R030	10.0	50			2.4	4	0.3	°	A79 0250 050 0400 100 R030	10.0	50	2.4	4			0.3	•
B66 0250 050 0400 120 R030	12.0	50			2.4	4	0.3	°	A79 0250 050 0400 120 R030	12.0	50	2.4	4			0.3	•
B66 0250 050 0400 140 R030	14.0	50			2.4	4	0.3	°	A79 0250 050 0400 140 R030	14.0	50	2.4	4			0.3	°
B66 0250 050 0400 160 R030	16.0	50			2.4	4	0.3	°	A79 0250 050 0400 160 R030	16.0	50	2.4	4			0.3	•
B66 0250 060 0400 R030	-	60			-	4	0.3	°	A79 0250 060 0400 R030	-	60	-	4			0.3	°
B66 0250 060 0400 180 R030	18.0	60			2.4	4	0.3	•	A79 0250 060 0400 180 R030	18.0	60	2.4	4			0.3	°
B66 0250 060 0400 200 R030	20.0	60			2.4	4	0.3	°	A79 0250 060 0400 200 R030	20.0	60	2.4	4			0.3	•
B66 0250 060 0400 250 R030	25.0	60			2.4	4	0.3	°	A79 0250 060 0400 250 R030	25.0	60	2.4	4			0.3	°
B66 0250 075 0400 R030	-	75			-	4	0.3	°	A79 0250 075 0400 R030	-	75	-	4			0.3	°
B66 0250 075 0400 300 R030	30.0	75			2.4	4	0.3	°	A79 0250 075 0400 300 R030	30.0	75	2.4	4			0.3	•
B66 0250 050 0400 R050	-	50			-	4	0.5	°	A79 0250 050 0400 R050	-	50	-	4			0.5	°
B66 0250 050 0400 080 R050	8.0	50			2.4	4	0.5	°	A79 0250 050 0400 080 R050	8.0	50	2.4	4			0.5	•
B66 0250 050 0400 120 R050	12.0	50			2.4	4	0.5	°	A79 0250 050 0400 120 R050	12.0	50	2.4	4			0.5	°
B66 0250 050 0400 160 R050	16.0	50			2.4	4	0.5	°	A79 0250 050 0400 160 R050	16.0	50	2.4	4			0.5	•
B66 0250 060 0400 R050	-	60	-	4	0.5	°	A79 0250 060 0400 R050	-	60	-	4	0.5	°				
B66 0250 060 0400 200 R050	20.0	60	2.4	4	0.5	°	A79 0250 060 0400 200 R050	20.0	60	2.4	4	0.5	°				
B66 0250 060 0400 250 R050	25.0	60	2.4	4	0.5	°	A79 0250 060 0400 250 R050	25.0	60	2.4	4	0.5	°				
B66 0250 075 0400 R050	-	75	-	4	0.5	°	A79 0250 075 0400 R050	-	75	-	4	0.5	°				
B66 0250 075 0400 300 R050	30.0	75	2.4	4	0.5	°	A79 0250 075 0400 300 R050	30.0	75	2.4	4	0.5	°				
B66 0300 050 0600 R020	3	4.5	-	50	-	6	0.2	°	A79 0300 050 0600 R020	3	4.5	-	50	-	6	0.2	°
B66 0300 050 0600 080 R020 *			8.0	50	2.8	6	0.2	°	A79 0300 050 0600 080 R020 *			8.0	50	2.8	6	0.2	°
B66 0300 050 0600 100 R020			10.0	50	2.8	6	0.2	°	A79 0300 050 0600 100 R020			10.0	50	2.8	6	0.2	°
B66 0300 050 0600 120 R020			12.0	50	2.8	6	0.2	°	A79 0300 050 0600 120 R020			12.0	50	2.8	6	0.2	•
B66 0300 050 0600 140 R020			14.0	50	2.8	6	0.2	°	A79 0300 050 0600 140 R020			14.0	50	2.8	6	0.2	•
B66 0300 060 0600 R020			-	60	-	6	0.2	°	A79 0300 060 0600 R020			-	60	-	6	0.2	°
B66 0300 060 0600 160 R020			16.0	60	2.8	6	0.2	°	A79 0300 060 0600 160 R020			16.0	60	2.8	6	0.2	•
B66 0300 060 0600 180 R020 *			18.0	60	2.8	6	0.2	°	A79 0300 060 0600 180 R020 *			18.0	60	2.8	6	0.2	°
B66 0300 060 0600 200 R020			20.0	60	2.8	6	0.2	°	A79 0300 060 0600 200 R020			20.0	60	2.8	6	0.2	•
B66 0300 075 0600 R020			-	75	-	6	0.2	°	A79 0300 075 0600 R020			-	75	-	6	0.2	°
B66 0300 075 0600 250 R020			25.0	75	2.8	6	0.2	°	A79 0300 075 0600 250 R020			25.0	75	2.8	6	0.2	•
B66 0300 050 0600 R030			-	50	-	6	0.3	°	A79 0300 050 0600 R030			-	50	-	6	0.3	°
B66 0300 050 0600 080 R030 *			8.0	50	2.8	6	0.3	°	A79 0300 050 0600 080 R030 *			8.0	50	2.8	6	0.3	•
B66 0300 050 0600 100 R030			10.0	50	2.8	6	0.3	°	A79 0300 050 0600 100 R030			10.0	50	2.8	6	0.3	•
B66 0300 050 0600 120 R030			12.0	50	2.8	6	0.3	°	A79 0300 050 0600 120 R030			12.0	50	2.8	6	0.3	•
B66 0300 050 0600 140 R030			14.0	50	2.8	6	0.3	°	A79 0300 050 0600 140 R030			14.0	50	2.8	6	0.3	°
B66 0300 060 0600 R030	-	60	-	6	0.3	°	A79 0300 060 0600 R030	-	60	-	6	0.3	°				
B66 0300 060 0600 160 R030	16.0	60	2.8	6	0.3	°	A79 0300 060 0600 160 R030	16.0	60	2.8	6	0.3	•				
B66 0300 060 0600 180 R030 *	18.0	60	2.8	6	0.3	°	A79 0300 060 0600 180 R030 *	18.0	60	2.8	6	0.3	•				

* - DIN 6535

cont'd ▶

D mm	Tol. μm
0.1 ~ 0.7	0 / -12
0.7 ~ 4.0	0 / -20

Material Group | Material-Gruppe | Groupe Matiere | Gruppo Materiali | 材质主类

Cutting Parameter

N01	N02	N03	K01	K02	P01	P02	P03	M01	M02	S01	S02	S03	H01	H02	O01	O02	227 - 229
-----	-----	-----	-----	-----	-----	-----	-----	-----	-----	-----	-----	-----	-----	-----	-----	-----	-----------

SE 45R MINIATURE TORUS ENDMILLS WITH LONG NECK, 2 FLUTES

- VHM SE 45R Toruskleinstfräser mit langem Hals, 2 Zähne
- Micro-frese toroidali SE 45, con collo lungo, 2 taglianti
- Micro-fraises SE 45 toriques avec cou long, 2 dents
- 整体硬质合金 SE 45R 系列 微小径2刃长颈平底铣刀



Order Number	Dimension (mm)							B0819	Order Number	Dimension (mm)							B0909
	D	I1	I2	L	d1	d2(h6)	R			D	I1	I2	L	d1	d2(h6)	R	
B66 0300 060 0600 200 R030	3	-	20.0	60	2.8	6	0.3	°	A79 0300 060 0600 200 R030	3	-	20.0	60	2.8	6	0.3	•
B66 0300 075 0600 R030			-	75	-	6	0.3	°	A79 0300 075 0600 R030			-	75	-	6	0.3	°
B66 0300 075 0600 250 R030			25.0	75	2.8	6	0.3	°	A79 0300 075 0600 250 R030			25.0	75	2.8	6	0.3	•
B66 0300 050 0600 R050			-	50	-	6	0.5	°	A79 0300 050 0600 R050			-	50	-	6	0.5	°
B66 0300 050 0600 080 R050 *			8.0	50	2.8	6	0.5	°	A79 0300 050 0600 080 R050 *			8.0	50	2.8	6	0.5	°
B66 0300 050 0600 100 R050			10.0	50	2.8	6	0.5	°	A79 0300 050 0600 100 R050			10.0	50	2.8	6	0.5	•
B66 0300 050 0600 120 R050			12.0	50	2.8	6	0.5	°	A79 0300 050 0600 120 R050			12.0	50	2.8	6	0.5	°
B66 0300 050 0600 140 R050			14.0	50	2.8	6	0.5	°	A79 0300 050 0600 140 R050			14.0	50	2.8	6	0.5	°
B66 0300 060 0600 R050			-	60	-	6	0.5	°	A79 0300 060 0600 R050			-	60	-	6	0.5	°
B66 0300 060 0600 160 R050			16.0	60	2.8	6	0.5	°	A79 0300 060 0600 160 R050			16.0	60	2.8	6	0.5	°
B66 0300 060 0600 180 R050 *			18.0	60	2.8	6	0.5	°	A79 0300 060 0600 180 R050 *			18.0	60	2.8	6	0.5	°
B66 0300 060 0600 200 R050			20.0	60	2.8	6	0.5	°	A79 0300 060 0600 200 R050			20.0	60	2.8	6	0.5	°
B66 0300 075 0600 R050	-	75	-	6	0.5	°	A79 0300 075 0600 R050	-	75	-	6	0.5	°				
B66 0300 075 0600 250 R050	25.0	75	2.8	6	0.5	°	A79 0300 075 0600 250 R050	25.0	75	2.8	6	0.5	°				
B66 0400 060 0600 R030	4.5	-	-	60	-	6	0.3	°	A79 0400 060 0600 R030	4.5	-	-	60	-	6	0.3	°
B66 0400 060 0600 100 R030			10.0	60	3.7	6	0.3	°	A79 0400 060 0600 100 R030			10.0	60	3.7	6	0.3	°
B66 0400 060 0600 150 R030			15.0	60	3.7	6	0.3	°	A79 0400 060 0600 150 R030			15.0	60	3.7	6	0.3	°
B66 0400 060 0600 200 R030			20.0	60	3.7	6	0.3	•	A79 0400 060 0600 200 R030			20.0	60	3.7	6	0.3	°
B66 0400 075 0600 R030			-	75	-	6	0.3	°	A79 0400 075 0600 R030			-	75	-	6	0.3	°
B66 0400 075 0600 250 R030			25.0	75	3.7	6	0.3	°	A79 0400 075 0600 250 R030			25.0	75	3.7	6	0.3	•
B66 0400 075 0600 300 R030			30.0	75	3.7	6	0.3	°	A79 0400 075 0600 300 R030			30.0	75	3.7	6	0.3	•
B66 0400 075 0600 400 R030			40	75	3.7	6	0.3	°	A79 0400 075 0600 400 R030			40	75	3.7	6	0.3	•
B66 0400 060 0600 R050			-	60	-	6	0.5	°	A79 0400 060 0600 R050			-	60	-	6	0.5	°
B66 0400 060 0600 100 R050			10	60	3.7	6	0.5	°	A79 0400 060 0600 100 R050			10	60	3.7	6	0.5	•
B66 0400 060 0600 150 R050			15	60	3.7	6	0.5	°	A79 0400 060 0600 150 R050			15	60	3.7	6	0.5	•
B66 0400 060 0600 200 R050			20	60	3.7	6	0.5	°	A79 0400 060 0600 200 R050			20	60	3.7	6	0.5	•
B66 0400 075 0600 R050	-	75	-	6	0.5	°	A79 0400 075 0600 R050	-	75	-	6	0.5	°				
B66 0400 075 0600 250 R050	25	75	3.7	6	0.5	°	A79 0400 075 0600 250 R050	25	75	3.7	6	0.5	•				
B66 0400 075 0600 300 R050	30	75	3.7	6	0.5	°	A79 0400 075 0600 300 R050	30	75	3.7	6	0.5	•				
B66 0400 075 0600 400 R050	40	75	3.7	6	0.5	°	A79 0400 075 0600 400 R050	40	75	3.7	6	0.5	•				

* - DIN 6535

D mm	Tol. μm
0.1 - 0.7	0 / -12
0.7 - 4.0	0 / -20

Material Group | Material-Gruppe | Groupe Matière | Gruppo Materiali | 材质主类

Cutting Parameter

N01	N02	N03	K01	K02	P01	P02	P03	M01	M02	S01	S02	S03	H01	H02	O01	O02	227 - 229
-----	-----	-----	-----	-----	-----	-----	-----	-----	-----	-----	-----	-----	-----	-----	-----	-----	-----------

SE 45 TORUS ENDMILLS WITH TAPER NECK, 2 FLUTES

- VHM SE 45R Torusfräser mit konischem Hals, 2 Zähne
- Frese toroidali SE 45, con collo conico, 2 taglienti
- Fraises SE 45 toriques avec cou conique, 2 dents
- 整体硬质合金 SE 45R 系列 2刀圆鼻铣刀 锥颈型

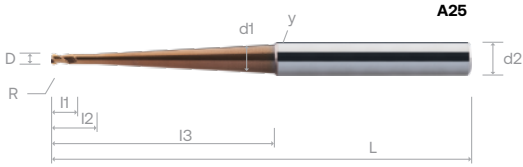
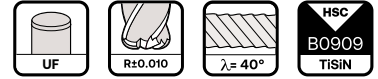

Order Number	Dimension (mm)								B0909
	D	I1	I2	I3	L	d2 (h6)	y	R	
A25 0100 020 06 080	1.0	1.5	4	20	60	6	8°	0.2	°
A25 0100 040 06 040			4	40	75	6	4.0°	0.2	°
A25 0150 020 06 070	1.5	2.3	7.5	20	60	6	7°	0.2	°
A25 0150 040 06 035			7.5	40	75	6	3.5°	0.2	°
A25 0200 020 06 057	2.0	3	8	20	60	6	5.7°	0.5	•
A25 0200 040 06 029			8	40	75	6	2.9°	0.5	•
A25 0200 040 06 010			8	40	75	6	1°	0.5	°
A25 0300 020 06 043			10	20	60	6	4.3°	0.5	•
A25 0300 040 06 021	3.0	3.5	12	40	75	6	2.1°	0.5	•
A25 0300 045 06 010			12	45	75	6	1°	0.5	°
A25 0400 020 06 029	4.0	4	12	20	60	6	2.9°	1	•
A25 0400 040 06 014			20	40	75	6	1.4°	1	•
A25 0400 060 06 010			20	60	100	6	1°	0.5	°
A25 0600 020 06 000			20	20	60	6	-	2	°
A25 0600 040 06 000	6.0	6	40	40	75	6	-	1	•
A25 0600 060 08 010			25	60	100	8	1°	2	°
A25 0600 080 08 010			25	80	125	8	1°	1	°
A25 0800 025 08 000			25	25	64	8	-	2	°
A25 0800 060 08 000	8.0	7	60	60	100	8	-	2	°
A25 0800 075 10 008			30	75	125	10	0.8°	1	°
A25 0800 105 10 006			20	105	150	10	0.6°	1	°
A25 1000 030 10 000			30	30	75	10	-	3	°
A25 1000 075 10 000	10.0	8	75	75	125	10	-	3	°
A25 1000 070 12 008			30	70	125	12	0.8°	3	°
A25 1200 035 12 000			35	35	100	12	-	4	°
A25 1200 070 12 000			70	70	125	12	-	4	°
A25 1200 100 16 012	12.0	10	35	100	150	16	1.2°	4	°

- ALL LINE
- EZ LINE - ENDMILL
- SE 30
- NITICO 30
- OPTIMUM
- SE 45
- SE 45X
- NITICO 45
- SE 60
- SE 60X
- DM70 - SE 70
- SE GR
- TE 45
- PLUNGE -MILL
- THREAD MILL

Material Group | Material-Gruppe | Groupe Matière | Gruppo Materiali | 材质主类

N01	N02	N03	K01	K02	P01	P02	P03	M01	M02	S01	S02	S03	H01	H02	O01	O02
-----	-----	-----	-----	-----	-----	-----	-----	-----	-----	-----	-----	-----	-----	-----	-----	-----

Cutting Parameter

230

SE 45 ENDMILLS, WITH SHORT FLUTE / WITH RECESS, 3 FLUTES

- VHM SE 45 Fräser, mit kurzen Nuten, 3 Zähne
- Frese SE 45 con taglienti corti, 3 taglienti
- Fraises SE 45 Standard à hélices courtes, 3 dents
- 整体硬质合金 SE 45 系列 3刃短刃平底铣刀

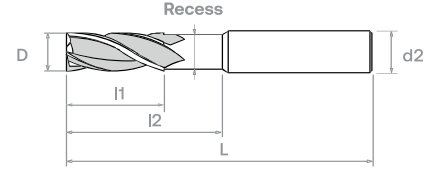
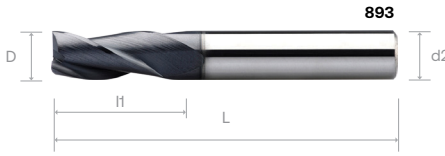

Order Number	Dimension (mm)					B0819	Order Number	Dimension (mm)					B0819	
	D	I1	I2	L	d2 (h6)			D	I1	I2	L	d2 (h6)		
893 0100 040 03	1	3		40	3	°	630 0100 040 03	1	3		40	3		
893 0100 040 04				40	4	°	630 0100 040 04				40	4		
893 0150 040 03	1.5	4.5		40	3	•	630 0150 040 03	1.5	4.5		40	3		
893 0150 040 04 *				40	4	°	630 0150 040 04				40	4		
893 0200 040 03 *	2	6.5		40	3	°	630 0200 040 03	2	6.5		40	3		
893 0200 040 04				40	4	•	630 0200 040 04				40	4		
893 0250 040 03	2.5			40	3	•	630 0250 040 03	2.5			40	3		
893 0250 040 04 *				40	4	°	630 0250 040 04				40	4		
893 0300	3	7		40	3	•	630 0300	3	7		15	40	3	•
893 0300 050 06				50	6	•	630 0300 050 06				15	50	6	°
893 0350 050 04	3.5			50	4	°	630 0350 050 04 *	3.5			20	50	4	°
893 0400				50	4	°	630 0400				20	50	4	•
893 0400 050 06 *	4	8		50	6	•	630 0400 050 06	4	8		20	50	6	°
893 0450 050 05				50	5	°	630 0450 050 05 *				20	50	5	°
893 0500	5	10		50	5	•	630 0500	5	10		20	50	5	°
893 0500 050 06 *				50	6	•	630 0500 050 06				20	50	6	°
893 0550 050 06 *	5.5			50	6	°	630 0550 050 06	5.5			20	50	6	°
893 0600 050				50	6	•	630 0600 050				20	50	6	°
893 0600 060	6	13		60	6	°	630 0600 060	6	13		30	60	6	°
893 0700 064 08				64	8	°	630 0700 064 08				30	64	8	°
893 0800	8	16		64	8	•	630 0800	8	16		30	64	8	°
893 0900 070 10				70	10	°	630 0900 070 10				32	70	10	°
893 1000 070	10	19		70	10	°	630 1000 070	10	19		32	70	10	°
893 1000 075				75	10	•	630 1000 075				32	75	10	°
893 1100 075 12 *	11	22		75	12	°	630 1100 075 12	11	22		37	75	12	°
893 1200				75	12	•	630 1200				37	75	12	°
893 1400	14			90	14	°	630 1400 *	14			44	90	14	°
893 1600				90	16	°	630 1600				46	90	16	°
893 1800	18	26		100	18	°	630 1800	18	26		53	100	18	°
893 2000				100	20	•	630 2000				58	100	20	°
893 2200	22	32		100	22	°	630 2200	22	32		58	100	22	°
893 2500				100	25	°	630 2500				58	100	25	°

* - DIN 6535

Material Group | Material-Gruppe | Groupe Matière | Gruppo Materiali | 材质主类

Cutting Parameter

N01	N02	N03	K01	K02	P01	P02	P03	M01	M02	S01	S02	S03	H01	H02	O01	O02	223
-----	-----	-----	-----	-----	-----	-----	-----	-----	-----	-----	-----	-----	-----	-----	-----	-----	-----

630 / 893 / A14 / A15



SE 45 ENDMILLS, WITH SHORT FLUTE / WITH RECESS, 3 FLUTES

- VHM SE 45 Standard Fräser, mit kurzen Nuten, 3 Zähne
- Frese SE 45 con taglienti corti, 3 taglienti
- Fraises SE 45 Standard à hélices courtes
- 整体硬质合金 SE 45 系列 3刃短刃平底铣刀

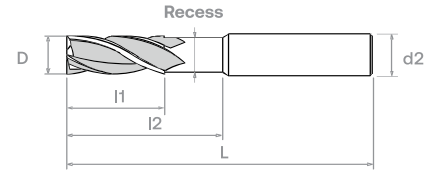

Order Number	Dimension (mm)					B0909	Order Number	Dimension (mm)					B0909
	D	I1	I2	L	d2 (h6)			D	I1	I2	L	d2 (h6)	
A14 0100 040 03	1	3		40	3	°	A15 0100 040 03	1	3		40	3	
A14 0100 040 04				40	4	°	A15 0100 040 04				40	4	
A14 0150 040 03	1.5	4.5		40	3	°	A15 0150 040 03	1.5	4.5		40	3	
A14 0150 040 04 *				40	4	°	A15 0150 040 04				40	4	
A14 0200 040 03 *	2	6.5		40	3	°	A15 0200 040 03	2	6.5		40	3	
A14 0200 040 04				40	4	°	A15 0200 040 04				40	4	
A14 0250 040 03	2.5			40	3	°	A15 0250 040 03	2.5			40	3	
A14 0250 040 04 *				40	4	°	A15 0250 040 04				40	4	
A14 0300	3	7		40	3	°	A15 0300	3	7	15	40	3	°
A14 0300 050 06				50	6	°	A15 0300 050 06				15	50	6
A14 0350 050 04	3.5	8		50	4	°	A15 0350 050 04 *	3.5	8	20	50	4	°
A14 0400				50	4	°	A15 0400 *				20	50	4
A14 0400 050 06 *	4			50	6	°	A15 0400 050 06	4		20	50	6	°
A14 0450 050 05				50	5	°	A15 0450 050 05 *				20	50	5
A14 0500	5	10		50	5	°	A15 0500	5	10	20	50	5	°
A14 0500 050 06 *				50	6	°	A15 0500 050 06				20	50	6
A14 0550 050 06 *	5.5			50	6	°	A15 0550 050 06	5.5		20	50	6	°
A14 0600 050				50	6	•	A15 0600 050				20	50	6
A14 0600 060	6	13		60	6	°	A15 0600 060	6	13	30	60	6	°
A14 0700 064 08				64	8	°	A15 0700 064 08				30	64	8
A14 0800	7	16		64	8	°	A15 0800	7	16	30	64	8	°
A14 0900 070 10				70	10	°	A15 0900 070 10				32	70	10
A14 1000 070	8	19		70	10	°	A15 1000 070	8	19	32	70	10	°
A14 1000 075				75	10	°	A15 1000 075				32	75	10
A14 1100 075 12 *	9	22		75	12	°	A15 1100 075 12	9	22	37	75	12	°
A14 1200				75	12	°	A15 1200				37	75	12
A14 1400	10	26		90	14	°	A15 1400	10	26	44	90	14	°
A14 1600				90	16	°	A15 1600				46	90	16
A14 1800	11	32		100	18	°	A15 1800	11	32	53	100	18	°
A14 2000				100	20	°	A15 2000				58	100	20
A14 2200	12			100	22	°	A15 2200	12		58	100	22	°
A14 2500				100	25	°	A15 2500				58	100	25

* - DIN 6535

ALL LINE
EZ LINE -
ENDMILL
SE 30
NITICO 30
OPTIMUM
SE 45
SE 45X
NITICO 45
SE 60
SE 60X
DN70 -
SE 70
SE GR
TE 45
PLUNGE
-MILL
THREAD
MILL

Material Group | Material-Gruppe | Groupe Matière | Gruppo Materiali | 材质主类

Cutting Parameter

N01	N02	N03	K01	K02	P01	P02	P03	M01	M02	S01	S02	S03	H01	H02	O01	O02
-----	-----	-----	-----	-----	-----	-----	-----	-----	-----	-----	-----	-----	-----	-----	-----	-----

223

886 / B31 / A04 / A05



SE 45 ENDMILLS / WITH RECESS, 2 FLUTES

- VHM SE 45 Fräser, 2 Zähne
- Frese SE 45, 2 taglienti
- Fraises SE 45 standard - 2 dents
- 整体硬质合金 SE 45 系列 2刃平底铣刀

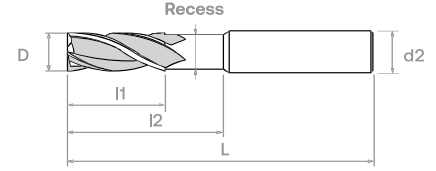
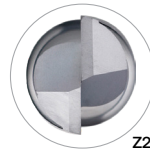

Order Number	Dimension (mm)					B0819	Order Number	Dimension (mm)					B0819	
	D	I1	I2	L	d2 (h6)			D	I1	I2	L	d2 (h6)		
886 0100 040 03	1	3		40	3	•	B31 0100 040 03	1	3		40	3	○	
886 0100 040 04				40	4	○	B31 0100 040 04				40	4	○	
886 0150 040 03	1.5	4.5		40	3	○	B31 0150 040 03	1.5	4.5		40	3	○	
886 0150 040 04 *				40	4	•	B31 0150 040 04				40	4	•	
886 0200 040 03 *	2	6.5		40	3	○	B31 0200 040 03	2	6.5		40	3	○	
886 0200 040 04				40	4	•	B31 0200 040 04				40	4	•	
886 0250 040 03	2.5			40	3	○	B31 0250 040 03	2.5			40	3	○	
886 0250 040 04 *				40	4	○	B31 0250 040 04				40	4	○	
886 0300	3	9		40	3	•	B31 0300	3	9		15	40	3	○
886 0300 050 06				50	6	•	B31 0300 050 06				15	50	6	○
886 0350 050 04	3.5			50	4	○	B31 0350 050 04 *	3.5			20	50	4	○
886 0400				50	4	○	B31 0400				20	50	4	○
886 0400 050 06	4	12		50	6	•	B31 0400 050 06	4	12		20	50	6	○
886 0450 050 05				50	5	•	B31 0450 050 05 *				20	50	5	○
886 0500	5	15		50	5	•	B31 0500	5	15		20	50	5	○
886 0500 050 06				50	6	•	B31 0500 050 06				20	50	6	○
886 0550 050 06	5.5			50	6	○	B31 0550 050 06	5.5			20	50	6	○
886 0600 050				50	6	•	B31 0600 050				20	50	6	○
886 0600 060	6	16		60	6	•	B31 0600 060	6	16		30	60	6	○
886 0700 064 08				64	8	○	B31 0700 064 08				30	64	8	○
886 0800	8	20		64	8	○	B31 0800	8	20		30	64	8	○
886 0900 070 10				70	10	○	B31 0900 070 10				32	70	10	○
886 1000 070	10	22		70	10	○	B31 1000 070	10	22		32	70	10	○
886 1000 075				75	10	•	B31 1000 075				32	75	10	○
886 1100 075 12 *	11	25		75	12	○	B31 1100 075 12	11	25		37	75	12	○
886 1200				75	12	•	B31 1200				37	75	12	○
886 1400	14	32		90	14	○	B31 1400	14	32		44	90	14	○
886 1600				90	16	•	B31 1600				46	90	16	○
886 1800	18	38		100	18	•	B31 1800	18	38		53	100	18	○
886 2000				100	20	○	B31 2000				58	100	20	○
886 2200	22	40		100	22	○	B31 2200	22	40		58	100	22	○
886 2500				100	25	○	B31 2500				58	100	25	○

* - DIN 6535

Material Group | Material-Gruppe | Groupe Matière | Gruppo Materiali | 材质主类

Cutting Parameter

N01	N02	N03	K01	K02	P01	P02	P03	M01	M02	S01	S02	S03	H01	H02	O01	O02	220
-----	-----	-----	-----	-----	-----	-----	-----	-----	-----	-----	-----	-----	-----	-----	-----	-----	-----

886 / B31 / A04 / A05



SE 45 ENDMILLS / WITH RECESS, 2 FLUTES

- VHM SE 45 Standard Fräser, 2 Zähne
- Frese SE 45, 2 taglienti
- Fraises SE 45 standard - 2 dents
- 整体硬质合金 SE 45 系列 2刃平底铣刀

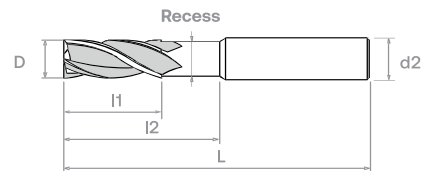
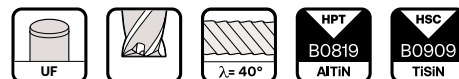

Order Number	Dimension (mm)					B0819	Order Number	Dimension (mm)					B0909	
	D	I1	I2	L	d2 (h6)			D	I1	I2	L	d2 (h6)		
A04 0100 040 03	1	3		40	3	°	A05 0100 040 03	1	3		40	3		
A04 0100 040 04				40	4	°	A05 0100 040 04				40	4		
A04 0150 040 03	1.5	4.5		40	3	°	A05 0150 040 03	1.5	4.5		40	3		
A04 0150 040 04 *				40	4	°	A05 0150 040 04				40	4		
A04 0200 040 03 *	2	6.5		40	3	•	A05 0200 040 03	2	6.5		40	3		
A04 0200 040 04				40	4	•	A05 0200 040 04				40	4		
A04 0250 040 03	2.5			40	3	•	A05 0250 040 03	2.5			40	3		
A04 0250 040 04 *				40	4	•	A05 0250 040 04				40	4		
A04 0300	3	9		40	3	•	A05 0300	3	9		40	3	°	
A04 0300 050 06				50	6	°	A05 0300 050 06				15	40	3	°
A04 0350 050 04	3.5	12		50	4	•	A05 0350 050 04 *	3.5	12		20	50	4	°
A04 0400				50	4	°	A05 0400				20	50	4	°
A04 0400 050 06	4			50	6	°	A05 0400 050 06	4			20	50	6	°
A04 0450 050 05				50	5	•	A05 0450 050 05 *				20	50	5	°
A04 0500	5	15		50	5	•	A05 0500	5	15		20	50	5	°
A04 0500 050 06				50	6	°	A05 0500 050 06				20	50	6	°
A04 0550 050 06	5.5	16		50	6	°	A05 0550 050 06	5.5	16		20	50	6	°
A04 0600 050				50	6	°	A05 0600 050				20	50	6	°
A04 0600 060	6	20		60	6	°	A05 0600 060	6	20		30	60	6	°
A04 0700 064 08				64	8	•	A05 0700 064 08				30	64	8	°
A04 0800	7			64	8	•	A05 0800	7			30	64	8	°
A04 0900 070 10				70	10	•	A05 0900 070 10				32	70	10	°
A04 1000 070	8	22		70	10	•	A05 1000 070	8	22		32	70	10	°
A04 1000 075				75	10	°	A05 1000 075				32	75	10	°
A04 1100 075 12 *	9	25		75	12	°	A05 1100 075 12	9	25		37	75	12	°
A04 1200				75	12	•	A05 1200				37	75	12	°
A04 1400	10	32		90	14	•	A05 1400	10	32		44	90	14	°
A04 1600				90	16	°	A05 1600				46	90	16	°
A04 1800	11	38		100	18	°	A05 1800	11	38		53	100	18	°
A04 2000				100	20	•	A05 2000				58	100	20	°
A04 2200	12	40		100	22	°	A05 2200	12	40		58	100	22	°
A04 2500				100	25	°	A05 2500				58	100	25	°

* - DIN 6535

- ALL LINE
- EZ LINE - ENDMILL
- SE 30
- NITICO 30
- OPTIMUM
- SE 45
- SE 45X
- NITICO 45
- SE 60
- SE 60X
- DN70 - SE 70
- SE GR
- TE 45
- PLUNGE -MILL
- THREAD MILL

Material Group | Material-Gruppe | Groupe Matière | Gruppo Materiali | 材质主类

Cutting Parameter

N01	N02	N03	K01	K02	P01	P02	P03	M01	M02	S01	S02	S03	H01	H02	O01	O02
-----	-----	-----	-----	-----	-----	-----	-----	-----	-----	-----	-----	-----	-----	-----	-----	-----

220

SE 45 LONG ENDMILLS, 4 FLUTES

- VHM SE45 Fräser, lang, 4 Zähne
- Frese lunghe SE 45, 4 taglienti
- Fraises SE 45 Longue - 4 dents
- 整体硬质合金 SE 45 系列 4刃长型平底铣刀



Order Number	Dimension (mm)					G6110	Order Number	Dimension (mm)					B0819
	D	l1	l2	L	d2 (h6)			D	l1	l2	L	d2 (h6)	
186 0300	3	19		60	3	•	889 0300	3	19		60	3	◦
186 0300 075 06				75	6	•	889 0300 075 06				75	6	◦
186 0400	4			60	4	•	889 0400	4			60	4	◦
186 0400 075 06				75	6	•	889 0400 075 06				75	6	•
186 0500	5		60	5	◦	889 0500	5		60	5	•		
186 0500 075 06			75	6	◦	889 0500 075 06			75	6	•		
186 0600	6	31		75	6	◦	889 0600	6	31		75	6	•
186 0800				75	8	◦	889 0800			8		75	8
186 1000 075	10			75	10	◦	889 1000 075	10				75	10
186 1000 100		50		100	10	•	889 1000 100		50		100	10	•
186 1200	12			100	12	•	889 1200	12			100	12	◦
186 1400		57		125	14	◦	889 1400		57		125	14	◦
186 1600			125	16	•	889 1600		125		16	•		
186 1800			125	18	◦	889 1800		125		18	◦		
186 2000	20		125	20	◦	889 2000	20		125	20	◦		

Order Number	Dimension (mm)					B0909	Order Number	Dimension (mm)					B0819	
	D	l1	l2	L	d2 (h6)			D	l1	l2	L	d2 (h6)		
A09 0300	3	19		60	3	◦								
A09 0300 075 06				75	6	•								
A09 0400	4			60	4	•								
A09 0400 075 06				75	6	•								
A09 0500	5		60	5	◦									
A09 0500 075 06			75	6	•									
A09 0600	6	31		75	6	•								
A09 0800				75	8	•								
A09 1000 075	10			75	10	◦								
A09 1000 100		50		100	10	•								
A09 1200	12			100	12	•								
A09 1400		57		125	14	•								
A09 1600			125	16	•									
A09 1800			125	18	◦									
A09 2000	20		125	20	•									

Material Group | Material-Gruppe | Groupe Matière | Gruppo Materiali | 材质主类

Cutting Parameter

N01	N02	N03	K01	K02	P01	P02	P03	M01	M02	S01	S02	S03	H01	H02	O01	O02	222
-----	-----	-----	-----	-----	-----	-----	-----	-----	-----	-----	-----	-----	-----	-----	-----	-----	-----

SE 45 EXTRA-LONG ENDMILLS, 4 FLUTES

- VHM SE45 Fräser,extra-lang, 4 Zähne
- Frese extra-lunghe SE 45, 4 taglienti
- Fraises SE 45 Extra-Longue- 4 dents
- 整体硬质合金 SE 45 系列 4刃加长型平底铣刀

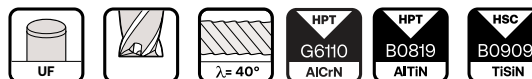

Order Number	Dimension (mm)					G6110	Order Number	Dimension (mm)					B0819
	D	I1	I2	L	d2 (h6)			D	I1	I2	L	d2 (h6)	
202 0300	3	25		100	3	◦	891 0300	3	25		100	3	•
202 0300 100 06				100	6	◦	891 0300 100 06				100	6	•
202 0400	4	31		100	4	◦	891 0400	4	31		100	4	•
202 0400 100 06				100	6	◦	891 0400 100 06				100	6	◦
202 0500	5	31		100	5	◦	891 0500	5	31		100	5	•
202 0500 100 06				100	6	◦	891 0500 100 06				100	6	•
202 0600	6	38		100	6	◦	891 0600	6	38		100	6	◦
202 0800	8	41		100	8	◦	891 0800	8	41		100	8	•
202 1000	10	57		125	10	◦	891 1000	10	57		125	10	◦
202 1200	12	75		150	12	◦	891 1200	12	75		150	12	◦
202 1400	14			150	14	◦	891 1400	14			150	14	◦
202 1600	16		150	16	◦	891 1600	16		150	16	•		
202 1800	18		150	18	◦	891 1800	18		150	18	•		
202 2000	20		150	20	◦	891 2000	20		150	20	•		

Order Number	Dimension (mm)					B0819	Order Number	Dimension (mm)					B0819
	D	I1	I2	L	d2 (h6)			D	I1	I2	L	d2 (h6)	
A11 0300	3	25		100	3	•							
A11 0300 100 06				100	6	◦							
A11 0400	4	31		100	4	•							
A11 0400 100 06				100	6	•							
A11 0500	5	31		100	5	•							
A11 0500 100 06				100	6	•							
A11 0600	6	38		100	6	•							
A11 0800	8	41		100	8	•							
A11 1000	10	57		125	10	•							
A11 1200	12	75		150	12	•							
A11 1400	14			150	14	•							
A11 1600	16		150	16	•								
A11 1800	18		150	18	◦								
A11 2000	20		150	20	•								





Material Group | Material-Gruppe | Groupe Matière | Gruppo Materiali | 材质主类

Cutting Parameter

N01	N02	N03	K01	K02	P01	P02	P03	M01	M02	S01	S02	S03	H01	H02	O01	O02
-----	-----	-----	-----	-----	-----	-----	-----	-----	-----	-----	-----	-----	-----	-----	-----	-----

222

SE 45 SHORT FLUTES, LONG REACH ENDMILLS - LONG / WITH RECESS, 4 FLUTES

-  VHM SE 45 LONG REACH Fräser, lang, mit kurzen Nuten, 4 Zähne
-  Frese lunghe SE 45 long-reach, con taglienti corti, 4 taglienti
-  Fraises SE 45 LONG REACH longues à hélices courtes, 4 dents
-  整体硬质合金 SE 45 系列 4刃长型长颈短刃平底铣刀

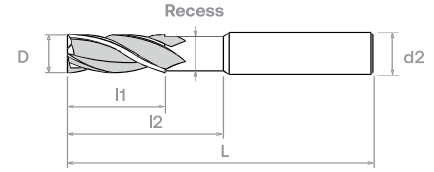
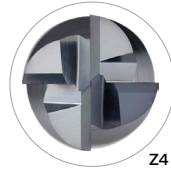
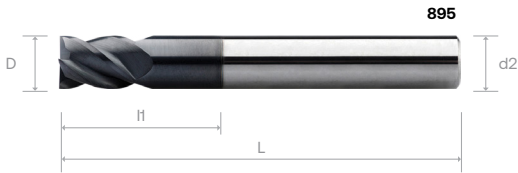
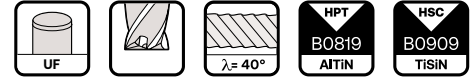

Order Number	Dimension (mm)					B0819	Order Number	Dimension (mm)					B0819
	D	I1	I2	L	d2 (h6)			D	I1	I2	L	d2 (h6)	
895 0300	3	5		60	3	○	897 0300	3	5	30	60	3	○
895 0300 075 06				75	6	○	897 0300 075 06			30	75	6	○
895 0400	4	8		60	4	○	897 0400	4	8	32	60	4	○
895 0400 075 06				75	6	●	897 0400 075 06			32	75	6	○
895 0500	5	9		60	5	○	897 0500	5	9	32	60	5	○
895 0500 075 06				75	6	○	897 0500 075 06			32	75	6	○
895 0600	6	10		75	6	●	897 0600	6	10	40	75	6	○
895 0800	8	12		75	8	○	897 0800	8	12	40	75	8	○
895 1000 075	10	14		75	10	○	897 1000 075	10	14	40	75	10	○
895 1000 100				100	10	○	897 1000 100			60	100	10	○
895 1200	12	16		100	12	○	897 1200	12	16	60	100	12	○
895 1400	14	22		125	14	○	897 1400	14	22	85	125	14	○
895 1600	16			125	16	○	897 1600	16		85	125	16	○
895 1800	18	26		125	18	○	897 1800	18	26	85	125	18	○
895 2000	20			125	20	●	897 2000	20		85	125	20	○

Order Number	Dimension (mm)					B0909	Order Number	Dimension (mm)					B0909
	D	I1	I2	L	d2 (h6)			D	I1	I2	L	d2 (h6)	
A18 0300	3	5		60	3	●	A19 0300	3	5	30	60	3	●
A18 0300 075 06				75	6	○	A19 0300 075 06			30	75	6	○
A18 0400	4	8		60	4	○	A19 0400	4	8	32	60	4	●
A18 0400 075 06				75	6	○	A19 0400 075 06			32	75	6	●
A18 0500	5	9		60	5	○	A19 0500	5	9	32	60	5	○
A18 0500 075 06				75	6	○	A19 0500 075 06			32	75	6	●
A18 0600	6	10		75	6	○	A19 0600	6	10	40	75	6	●
A18 0800	8	12		75	8	○	A19 0800	8	12	40	75	8	●
A18 1000 075	10	14		75	10	○	A19 1000 075	10	14	40	75	10	●
A18 1000 100				100	10	○	A19 1000 100			60	100	10	●
A18 1200	12	16		100	12	●	A19 1200	12	16	60	100	12	●
A18 1400	14	22		125	14	○	A19 1400	14	22	85	125	14	●
A18 1600	16			125	16	○	A19 1600	16		85	125	16	●
A18 1800	18	26		125	18	○	A19 1800	18	26	85	125	18	○
A18 2000	20			125	20	○	A19 2000	20		85	125	20	●

* - DIN 6535

Material Group | Material-Gruppe | Groupe Matière | Gruppo Materiali | 材质主类

Cutting Parameter

N01	N02	N03	K01	K02	P01	P02	P03	M01	M02	S01	S02	S03	H01	H02	O01	O02	224
-----	-----	-----	-----	-----	-----	-----	-----	-----	-----	-----	-----	-----	-----	-----	-----	-----	-----

899 / 901 / A22 / A23



SE 45 SHORT FLUTES, LONG REACH ENDMILLS - EXTRA-LONG / WITH RECESS, 4 FLUTES

- VHM SE 45 LONG REACH Fräser, extra-lang, mit kurzen Nuten, 4 Zähne
- Frese extra-lunghe SE 45 long-reach, con taglienti corti, 4 taglienti
- Fraises SE 45 LONG REACH extra-longues à hélices courtes, 4 dents
- 整体硬质合金 SE 45 系列 4刃加长型长颈短刃平底铣刀

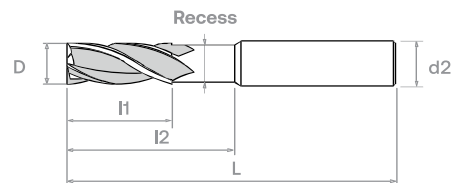
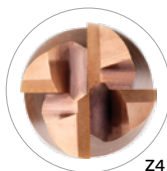
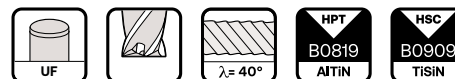

Order Number	Dimension (mm)					B0819	Order Number	Dimension (mm)					B0819
	D	l1	l2	L	d2 (h6)			D	l1	l2	L	d2 (h6)	
899 0300	3	5		100	3	○	901 0300	3	5	60	100	3	○
899 0300 100 06				100	6	●	901 0300 100 06			60	100	6	●
899 0400	4	8		100	4	○	901 0400	4	8	60	100	4	○
899 0400 100 06				100	6	○	901 0400 100 06 *			60	100	6	●
899 0500	5	9		100	5	○	901 0500	5	9	60	100	5	○
899 0500 100 06				100	6	○	901 0500 100 06			60	100	6	●
899 0600	6	10		100	6	●	901 0600	6	10	60	100	6	●
899 0800	8	12		100	8	●	901 0800	8	12	60	100	8	●
899 1000	10	14		125	10	○	901 1000 *	10	14	85	125	10	●
899 1200	12	16		150	12	○	901 1200	12	16	110	150	12	●
899 1400	14	22		150	14	○	901 1400	14	22	110	150	14	○
899 1600	16			150	16	○	901 1600	16			110	150	16
899 1800	18	26		150	18	○	901 1800	18	26	110	150	18	○
899 2000	20			150	20	○	901 2000	20			110	150	20

Order Number	Dimension (mm)					B0909	Order Number	Dimension (mm)					B0909
	D	l1	l2	L	d2 (h6)			D	l1	l2	L	d2 (h6)	
A22 0300	3	5		100	3	○	A23 0300	3	5	60	100	3	○
A22 0300 100 06				100	6	○	A23 0300 100 06			60	100	6	○
A22 0400	4	8		100	4	○	A23 0400	4	8	60	100	4	○
A22 0400 100 06				100	6	○	A23 0400 100 06 *			60	100	6	○
A22 0500	5	9		100	5	○	A23 0500	5	9	60	100	5	○
A22 0500 100 06				100	6	○	A23 0500 100 06			60	100	6	○
A22 0600	6	10		100	6	○	A23 0600	6	10	60	100	6	●
A22 0800	8	12		100	8	●	A23 0800	8	12	60	100	8	○
A22 1000	10	14		125	10	○	A23 1000 *	10	14	85	125	10	○
A22 1200	12	16		150	12	●	A23 1200	12	16	110	150	12	●
A22 1400	14	22		150	14	○	A23 1400	14	22	110	150	14	○
A22 1600	16			150	16	○	A23 1600	16			110	150	16
A22 1800	18	26		150	18	○	A23 1800	18	26	110	150	18	○
A22 2000	20			150	20	○	A23 2000	20			110	150	20

* - DIN 6535

Material Group | Material-Gruppe | Groupe Matière | Gruppo Materiali | 材质主类

Cutting Parameter

N01	N02	N03	K01	K02	P01	P02	P03	M01	M02	S01	S02	S03	H01	H02	O01	O02
-----	-----	-----	-----	-----	-----	-----	-----	-----	-----	-----	-----	-----	-----	-----	-----	-----

225

ALL LINE
EZ LINE -
ENDMILL
SE 30
NITICO 30
OPTIMUM
SE 45
SE 45X
NITICO 45
SE 60
SE 60X
DN70 -
SE 70
SE GR
TE 45
PLUNGE
-MILL
THREAD
MILL

SE 45R TORUS ENDMILLS, 4 FLUTES

- VHM SE 45R Standard Torusfräser, 4 Zähne
- Frese toroidali SE 45, 4 taglienti
- Fraises SE 45 toriques Standard, 4 dents
- 整体硬质合金 SE 45R 系列 4刃圆鼻铣刀

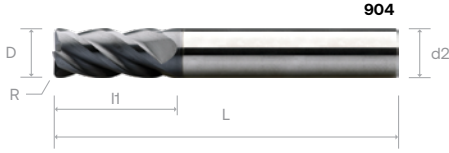

Order Number	Dimension (mm)						G6110	Order Number	Dimension (mm)						B0819	
	D	I1	I2	L	d2 (h6)	R			D	I1	I2	L	d2 (h6)	R		
311 0100 050 0400 020	1	3		50	4	0.2	°	904 0100 050 0400 020	1	3		50	4	0.2	°	B0819
311 0100 050 0600 020				50	6	0.2	°	904 0100 050 0600 020				50	6	0.2	•	
311 0150 050 0400 020	1.5	4.5		50	4	0.2	°	904 0150 050 0400 020	1.5	4.5		50	4	0.2	°	B0819
311 0150 050 0600 020				50	6	0.2	°	904 0150 050 0600 020				50	6	0.2	•	
311 0200 050 0400 020	2			50	4	0.2	•	904 0200 050 0400 020	2			50	4	0.2	°	B0819
311 0200 050 0400 030				50	4	0.3	°	904 0200 050 0400 030				50	4	0.3	°	
311 0200 050 0600 020	2			50	6	0.2	°	904 0200 050 0600 020	2			50	6	0.2	•	B0819
311 0200 050 0600 030				50	6	0.3	°	904 0200 050 0600 030				50	6	0.3	°	
311 0250 050 0400 020	2.5	6.5		50	4	0.2	°	904 0250 050 0400 020	2.5	6.5		50	4	0.2	°	B0819
311 0250 050 0400 030				50	4	0.3	°	904 0250 050 0400 030				50	4	0.3	°	
311 0250 050 0400 050	2.5			50	4	0.5	°	904 0250 050 0400 050	2.5			50	4	0.5	°	B0819
311 0250 050 0600 020				50	6	0.2	°	904 0250 050 0600 020				50	6	0.2	•	
311 0250 050 0600 030	2.5			50	6	0.3	°	904 0250 050 0600 030	2.5			50	6	0.3	•	B0819
311 0250 050 0600 050				50	6	0.5	°	904 0250 050 0600 050				50	6	0.5	°	
311 0300 040 0300 020	3	9		40	3	0.2	°	904 0300 040 0300 020	3	9		40	3	0.2	°	B0819
311 0300 040 0300 030				40	3	0.3	•	904 0300 040 0300 030				40	3	0.3	•	
311 0300 040 0300 050	3	9		40	3	0.5	•	904 0300 040 0300 050	3	9		40	3	0.5	•	B0819
311 0300 050 0400 020				50	4	0.2	°	904 0300 050 0400 020				50	4	0.2	°	
311 0300 050 0400 030	3	9		50	4	0.3	°	904 0300 050 0400 030	3	9		50	4	0.3	•	B0819
311 0300 050 0400 050				50	4	0.5	•	904 0300 050 0400 050				50	4	0.5	•	
311 0300 050 0600 020	3	9		50	6	0.2	°	904 0300 050 0600 020	3	9		50	6	0.2	°	B0819
311 0300 050 0600 030				50	6	0.3	°	904 0300 050 0600 030				50	6	0.3	•	
311 0300 050 0600 050	3	9		50	6	0.5	°	904 0300 050 0600 050	3	9		50	6	0.5	•	B0819
311 0300 060 0600 020				50	6	0.2	°	904 0300 060 0600 020				50	6	0.2	°	
311 0300 060 0600 030	3	9		50	6	0.3	°	904 0300 060 0600 030	3	9		50	6	0.3	°	B0819
311 0300 060 0600 050				50	6	0.5	•	904 0300 060 0600 050				50	6	0.5	°	
311 0400 050 0400 020	4	12		50	4	0.2	°	904 0400 050 0400 020	4	12		50	4	0.2	•	B0819
311 0400 050 0400 030				50	4	0.3	°	904 0400 050 0400 030				50	4	0.3	°	
311 0400 050 0400 050	4	12		50	4	0.5	°	904 0400 050 0400 050	4	12		50	4	0.5	•	B0819
311 0400 050 0400 100				50	4	1	•	904 0400 050 0400 100				50	4	1	•	
311 0400 050 0600 020	4	12		50	6	0.2	°	904 0400 050 0600 020	4	12		50	6	0.2	°	B0819
311 0400 050 0600 030				50	6	0.3	°	904 0400 050 0600 030				50	6	0.3	•	
311 0400 050 0600 050	4	12		50	6	0.5	°	904 0400 050 0600 050	4	12		50	6	0.5	•	B0819
311 0400 050 0600 100				50	6	1	•	904 0400 050 0600 100				50	6	1	•	
311 0400 060 0600 020	4	12		60	6	0.2	°	904 0400 060 0600 020	4	12		60	6	0.2	°	B0819
311 0400 060 0600 030				60	6	0.3	°	904 0400 060 0600 030				60	6	0.3	°	
311 0400 060 0600 050	4	12		60	6	0.5	°	904 0400 060 0600 050	4	12		60	6	0.5	•	B0819
311 0400 060 0600 100				60	6	1	•	904 0400 060 0600 100				60	6	1	•	
311 0500 050 0500 020	5	15		50	5	0.2	°	904 0500 050 0500 020	5	15		50	5	0.2	°	B0819
311 0500 050 0500 030				50	5	0.3	°	904 0500 050 0500 030				50	5	0.3	°	
311 0500 050 0500 050	5	15		50	5	0.5	•	904 0500 050 0500 050	5	15		50	5	0.5	•	B0819
311 0500 050 0500 100				50	5	1	•	904 0500 050 0500 100				50	5	1	•	
311 0500 050 0600 020	5	15		50	6	0.2	°	904 0500 050 0600 020	5	15		50	6	0.2	°	B0819
311 0500 050 0600 030				50	6	0.3	°	904 0500 050 0600 030				50	6	0.3	•	
311 0500 050 0600 050	5	15		50	6	0.5	°	904 0500 050 0600 050	5	15		50	6	0.5	•	B0819
311 0500 050 0600 100				50	6	1	•	904 0500 050 0600 100				50	6	1	•	
311 0500 060 0600 020	5	15		60	6	0.2	°	904 0500 060 0600 020	5	15		60	6	0.2	°	B0819
311 0500 060 0600 030				60	6	0.3	°	904 0500 060 0600 030				60	6	0.3	°	
311 0500 060 0600 050	5	15		60	6	0.5	°	904 0500 060 0600 050	5	15		60	6	0.5	°	B0819
311 0500 060 0600 100				60	6	1	•	904 0500 060 0600 100				60	6	1	•	
311 0600 050 0600 020	6	16		50	6	0.2	°	904 0600 050 0600 020	6	16		50	6	0.2	°	B0819
311 0600 050 0600 030				50	6	0.3	°	904 0600 050 0600 030				50	6	0.3	°	
311 0600 050 0600 050	6	16		50	6	0.5	°	904 0600 050 0600 050	6	16		50	6	0.5	•	B0819
311 0600 050 0600 100				50	6	1	•	904 0600 050 0600 100				50	6	1	•	

cont'd ▶

Material Group | Material-Gruppe | Groupe Matière | Gruppo Materiali | 材质主类

Cutting Parameter

N01	N02	N03	K01	K02	P01	P02	P03	M01	M02	S01	S02	S03	H01	H02	O01	O02	221
-----	-----	-----	-----	-----	-----	-----	-----	-----	-----	-----	-----	-----	-----	-----	-----	-----	-----

SE 45 MINIATURE ENDMILLS WITH LONG NECK, 2 FLUTES

- VHM SE 45 Kleinstfräser mit langem Hals, 2 Zähne
- Micro-frese SE 45, con collo lungo, 2 taglienti
- Micro-fraises SE 45 avec cou long, 2 dents
- 整体硬质合金 SE 45 系列 微小径2刃长颈平底铣刀

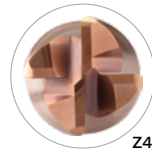

Order Number	Dimension (mm)						B0909	Order Number	Dimension (mm)						B0909			
	D	l1	l2	L	d2 (h6)	R			D	l1	l2	L	d2 (h6)	R				
A26 0100 050 0400 020	1	3		50	4	0.2	•											
A26 0100 050 0600 020				50	6	0.2	•											
A26 0150 050 0400 020	1.5	4.5		50	4	0.2	•											
A26 0150 050 0600 020				50	6	0.2	•											
A26 0200 050 0400 020	2			50	4	0.2	•											
A26 0200 050 0400 030				50	4	0.3	•											
A26 0200 050 0600 020				50	6	0.2	•											
A26 0200 050 0600 030				50	6	0.3	•											
A26 0250 050 0400 020	2.5	6.5		50	4	0.2	•											
A26 0250 050 0400 030				50	4	0.3	•											
A26 0250 050 0400 050				50	4	0.5	•											
A26 0250 050 0600 020				50	6	0.2	•											
A26 0250 050 0600 030				50	6	0.3	•											
A26 0250 050 0600 050				50	6	0.5	•											
A26 0300 040 0300 020	3	9		40	3	0.2	•											
A26 0300 040 0300 030				40	3	0.3	•											
A26 0300 040 0300 050				40	3	0.5	•											
A26 0300 050 0400 020				50	4	0.2	•											
A26 0300 050 0400 030				50	4	0.3	•											
A26 0300 050 0400 050				50	4	0.5	•											
A26 0300 050 0600 020				50	6	0.2	•											
A26 0300 050 0600 030				50	6	0.3	•											
A26 0300 050 0600 050				50	6	0.5	•											
A26 0300 060 0600 020				50	6	0.2	•											
A26 0300 060 0600 030				50	6	0.3	•											
A26 0300 060 0600 050				50	6	0.5	•											
A26 0400 050 0400 020	4	12		50	4	0.2	•											
A26 0400 050 0400 030				50	4	0.3	•											
A26 0400 050 0400 050				50	4	0.5	•											
A26 0400 050 0400 100				50	4	1	•											
A26 0400 050 0600 020				50	6	0.2	•											
A26 0400 050 0600 030				50	6	0.3	•											
A26 0400 050 0600 050				50	6	0.5	•											
A26 0400 050 0600 100				50	6	1	•											
A26 0400 060 0600 020				60	6	0.2	•											
A26 0400 060 0600 030				60	6	0.3	•											
A26 0400 060 0600 050				60	6	0.5	•											
A26 0400 060 0600 100				60	6	1	•											
A26 0500 050 0500 020	5	15		50	5	0.2	•											
A26 0500 050 0500 030				50	5	0.3	•											
A26 0500 050 0500 050				50	5	0.5	•											
A26 0500 050 0500 100				50	5	1	•											
A26 0500 050 0600 020				50	6	0.2	•											
A26 0500 050 0600 030				50	6	0.3	•											
A26 0500 050 0600 050				50	6	0.5	•											
A26 0500 050 0600 100				50	6	1	•											
A26 0500 060 0600 020				60	6	0.2	•											
A26 0500 060 0600 030				60	6	0.3	•											
A26 0500 060 0600 050				60	6	0.5	•											
A26 0500 060 0600 100				60	6	1	•											
A26 0600 050 0600 020	6	16		50	6	0.2	•											
A26 0600 050 0600 030				50	6	0.3	•											
A26 0600 050 0600 050				50	6	0.5	•											
A26 0600 050 0600 100		50	6	1	•													

cont'd ▶

Material Group | Material-Gruppe | Groupe Matière | Gruppo Materiali | 材质主类

Cutting Parameter

N01 N02 N03 K01 K02 P01 P02 P03 M01 M02 S01 S02 S03 H01 H02 O01 O02

221

ALL LINE
 EZ LINE - ENDMILL
 SE 30
 NITICO 30
 OPTIMUM
 SE 45
 SE 45X
 NITICO 45
 SE 60
 SE 60X
 DN70 - SE 70
 SE GR
 TE 45
 PLUNGE -MILL
 THREAD MILL

SE 45R TORUS ENDMILLS, 4 FLUTES

- VHM SE 45R Standard Torusfräser, 4 Zähne
- Frese toroidali SE 45, 4 taglienti
- Fraises SE 45 toriques Standard, 4 dents
- 整体硬质合金 SE 45R 系列 4刃圆鼻铣刀

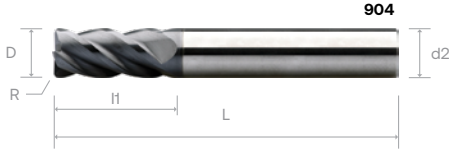

Order Number	Dimension (mm)						G6110	Order Number	Dimension (mm)						B0819	
	D	I1	I2	L	d2 (h6)	R			D	I1	I2	L	d2 (h6)	R		
311 0600 060 0600 020	6	20		60	6	0.2	•	904 0600 060 0600 020	6	20		60	6	0.2	•	904 0600 060 0600 020
311 0600 060 0600 030				60	6	0.3	•	904 0600 060 0600 030								
311 0600 060 0600 050				60	6	0.5	•	904 0600 060 0600 050								
311 0600 060 0600 100				60	6	1	•	904 0600 060 0600 100								
311 0800 064 0800 020				64	8	0.2	◦	904 0800 064 0800 020								
311 0800 064 0800 030				64	8	0.3	◦	904 0800 064 0800 030								
311 0800 064 0800 050	8	20		64	8	0.5	•	904 0800 064 0800 050	8	20		64	8	0.5	•	904 0800 064 0800 050
311 0800 064 0800 100				64	8	1	•	904 0800 064 0800 100								
311 0800 064 0800 150				64	8	1.5	•	904 0800 064 0800 150								
311 0800 064 0800 200				64	8	2	•	904 0800 064 0800 200								
311 1000 070 1000 020				70	10	0.2	◦	904 1000 070 1000 020								
311 1000 070 1000 030				70	10	0.3	◦	904 1000 070 1000 030								
311 1000 070 1000 050	10	22		70	10	0.5	•	904 1000 070 1000 050	10	22		70	10	0.5	◦	904 1000 070 1000 050
311 1000 070 1000 100				70	10	1	◦	904 1000 070 1000 100								
311 1000 070 1000 150				70	10	1.5	◦	904 1000 070 1000 150								
311 1000 070 1000 200				70	10	2	◦	904 1000 070 1000 200								
311 1000 075 1000 020				75	10	0.2	◦	904 1000 075 1000 020								
311 1000 075 1000 030				75	10	0.3	◦	904 1000 075 1000 030								
311 1000 075 1000 050		75	10	0.5	◦	904 1000 075 1000 050										
311 1000 075 1000 100		75	10	1	•	904 1000 075 1000 100		75	10	1	•	904 1000 075 1000 100				
311 1000 075 1000 150		75	10	1.5	◦	904 1000 075 1000 150		75	10	1.5	•	904 1000 075 1000 150				
311 1000 075 1000 200		75	10	2	◦	904 1000 075 1000 200		75	10	2	•	904 1000 075 1000 200				
311 1200 075 1200 020	12	25		75	12	0.2	◦	904 1200 075 1200 020	12	25		75	12	0.2	◦	904 1200 075 1200 020
311 1200 075 1200 030				75	12	0.3	•	904 1200 075 1200 030								
311 1200 075 1200 050				75	12	0.5	•	904 1200 075 1200 050								
311 1200 075 1200 100				75	12	1	◦	904 1200 075 1200 100								
311 1200 075 1200 150				75	12	1.5	◦	904 1200 075 1200 150								
311 1200 075 1200 200				75	12	2	•	904 1200 075 1200 200								
311 1400 090 1400 030	14	32		90	14	0.3	◦	904 1400 090 1400 030	14	32		90	14	0.3	◦	904 1400 090 1400 030
311 1400 090 1400 050				90	14	0.5	◦	904 1400 090 1400 050								
311 1400 090 1400 100				90	14	1	◦	904 1400 090 1400 100								
311 1400 090 1400 150				90	14	1.5	◦	904 1400 090 1400 150								
311 1400 090 1400 200				90	14	2	◦	904 1400 090 1400 200								
311 1400 090 1400 300				90	14	3	◦	904 1400 090 1400 300								
311 1600 090 1600 030	16	38		90	16	0.3	◦	904 1600 090 1600 030	16	38		90	16	0.3	◦	904 1600 090 1600 030
311 1600 090 1600 050				90	16	0.5	◦	904 1600 090 1600 050								
311 1600 090 1600 100				90	16	1	•	904 1600 090 1600 100								
311 1600 090 1600 150				90	16	1.5	◦	904 1600 090 1600 150								
311 1600 090 1600 200				90	16	2	◦	904 1600 090 1600 200								
311 1600 090 1600 300				90	16	3	◦	904 1600 090 1600 300								
311 1800 100 1800 030	18	38		100	18	0.3	◦	904 1800 100 1800 030	18	38		100	18	0.3	◦	904 1800 100 1800 030
311 1800 100 1800 050				100	18	0.5	◦	904 1800 100 1800 050								
311 1800 100 1800 100				100	18	1	◦	904 1800 100 1800 100								
311 1800 100 1800 150				100	18	1.5	◦	904 1800 100 1800 150								
311 1800 100 1800 200				100	18	2	◦	904 1800 100 1800 200								
311 1800 100 1800 300				100	18	3	◦	904 1800 100 1800 300								
311 2000 100 2000 030	20	38		100	20	0.3	◦	904 2000 100 2000 030	20	38		100	20	0.3	◦	904 2000 100 2000 030
311 2000 100 2000 050				100	20	0.5	•	904 2000 100 2000 050								
311 2000 100 2000 100				100	20	1	◦	904 2000 100 2000 100								
311 2000 100 2000 150				100	20	1.5	◦	904 2000 100 2000 150								
311 2000 100 2000 200				100	20	2	◦	904 2000 100 2000 200								
311 2000 100 2000 300				100	20	3	◦	904 2000 100 2000 300								

cont'd ▶

Material Group | Material-Gruppe | Groupe Matière | Gruppo Materiali | 材质主类

Cutting Parameter

N01	N02	N03	K01	K02	P01	P02	P03	M01	M02	S01	S02	S03	H01	H02	O01	O02	221
-----	-----	-----	-----	-----	-----	-----	-----	-----	-----	-----	-----	-----	-----	-----	-----	-----	-----

SE 45 MINIATURE ENDMILLS WITH LONG NECK, 2 FLUTES

- VHM SE 45 Kleinstfräser mit langem Hals, 2 Zähne
- Micro-frese SE 45, con collo lungo, 2 taglienti
- Micro-fraises SE 45 avec cou long, 2 dents
- 整体硬质合金 SE 45 系列 微小径2刃长颈平底铣刀

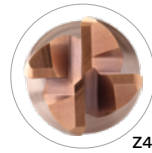

Order Number	Dimension (mm)						B0909	Order Number	Dimension (mm)						B0909			
	D	I1	I2	L	d2 (h6)	R			D	I1	I2	L	d2 (h6)	R				
A26 0600 060 0600 020	6	20		60	6	0.2	•											
A26 0600 060 0600 030				60	6	0.3	•											
A26 0600 060 0600 050				60	6	0.5	•											
A26 0600 060 0600 100				60	6	1	•											
A26 0800 064 0800 020			8	20		64	8	0.2	•									
A26 0800 064 0800 030						64	8	0.3	•									
A26 0800 064 0800 050		64			8	0.5	•											
A26 0800 064 0800 100		64			8	1	•											
A26 0800 064 0800 150		64			8	1.5	•											
A26 0800 064 0800 200		64			8	2	•											
A26 1000 070 1000 020	10	22		70	10	0.2	◦											
A26 1000 070 1000 030				70	10	0.3	•											
A26 1000 070 1000 050				70	10	0.5	•											
A26 1000 070 1000 100				70	10	1	•											
A26 1000 070 1000 150				70	10	1.5	◦											
A26 1000 070 1000 200				70	10	2	◦											
A26 1000 075 1000 020				75	10	0.2	◦											
A26 1000 075 1000 030				75	10	0.3	•											
A26 1000 075 1000 050				75	10	0.5	•											
A26 1000 075 1000 100				75	10	1	•											
A26 1000 075 1000 150				75	10	1.5	•											
A26 1000 075 1000 200				75	10	2	•											
A26 1200 075 1200 020	12	25		75	12	0.2	◦											
A26 1200 075 1200 030				75	12	0.3	◦											
A26 1200 075 1200 050				75	12	0.5	•											
A26 1200 075 1200 100				75	12	1	•											
A26 1200 075 1200 150				75	12	1.5	•											
A26 1200 075 1200 200				75	12	2	•											
A26 1200 075 1200 300		75	12	3	•													
A26 1400 090 1400 030	14	32		90	14	0.3	◦											
A26 1400 090 1400 050				90	14	0.5	◦											
A26 1400 090 1400 100				90	14	1	◦											
A26 1400 090 1400 150				90	14	1.5	◦											
A26 1400 090 1400 200				90	14	2	◦											
A26 1400 090 1400 300				90	14	3	◦											
A26 1600 090 1600 030	16	32		90	16	0.3	◦											
A26 1600 090 1600 050				90	16	0.5	•											
A26 1600 090 1600 100				90	16	1	•											
A26 1600 090 1600 150				90	16	1.5	◦											
A26 1600 090 1600 200				90	16	2	◦											
A26 1600 090 1600 300				90	16	3	◦											
A26 1800 100 1800 030	18	38		100	18	0.3	◦											
A26 1800 100 1800 050				100	18	0.5	◦											
A26 1800 100 1800 100				100	18	1	◦											
A26 1800 100 1800 150				100	18	1.5	◦											
A26 1800 100 1800 200				100	18	2	◦											
A26 1800 100 1800 300				100	18	3	◦											
A26 2000 100 2000 030	20	38		100	20	0.3	◦											
A26 2000 100 2000 050				100	20	0.5	•											
A26 2000 100 2000 100				100	20	1	◦											
A26 2000 100 2000 150				100	20	1.5	◦											
A26 2000 100 2000 200				100	20	2	◦											
A26 2000 100 2000 300				100	20	3	◦											

- ALL LINE
- EZ LINE - ENDMILL
- SE 30
- NITICO 30
- OPTIMUM
- SE 45
- SE 45X
- NITICO 45
- SE 60
- SE 60X
- DM70 - SE 70
- SE GR
- TE 45
- PLUNGE -MILL
- THREAD MILL

Material Group | Material-Gruppe | Groupe Matière | Gruppo Materiali | 材质主类

Cutting Parameter

N01	N02	N03	K01	K02	P01	P02	P03	M01	M02	S01	S02	S03	H01	H02	O01	O02	221
-----	-----	-----	-----	-----	-----	-----	-----	-----	-----	-----	-----	-----	-----	-----	-----	-----	-----

906 / 786 / A28 / A99



SE 45R TORUS SHORT FLUTES LONG REACH ENDMILLS - LONG / WITH RECESS, 2 FLUTES

- VHM SE 45R LONG REACH Torusfräser, lang, kurze Nuten, 2 Zähne
- Frese toroidali lunghe SE 45R long-reach, taglianti corti, 2 taglianti
- Fraises SE 45R LONG REACH toriques longues, dents courtes, 2 dents
- 整体硬质合金 SE 45R 系列 2刃长型长颈短刃圆鼻铣刀

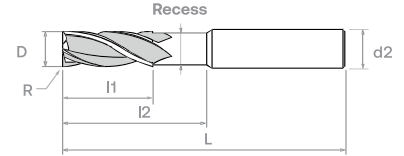
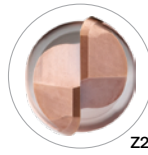

Order Number	Dimension (mm)						B0819	Order Number	Dimension (mm)						B0819	
	D	l1	l2	L	d2 (h6)	R			D	l1	l2	L	d2 (h6)	R		
906 0200 075 0600 030	2	4		75	6	0.3	○	786 0200 075 0600 030 *	2	4	30	75	6	0.3	○	
906 0300 075 0600 030	3	5		75	6	0.3	○	786 0300 075 0600 030	3	5	30	75	6	0.3	○	
906 0300 075 0600 050			75	6	0.5	○	786 0300 075 0600 050	30			75	6	0.5	○		
906 0400 075 0600 030	4	8		75	6	0.3	●	786 0400 075 0600 030	4	8	32	75	6	0.3	○	
906 0400 075 0600 050			75	6	0.5	○	786 0400 075 0600 050	32			75	6	0.5	○		
906 0500 075 0600 030	5	9		75	6	0.3	○	786 0500 075 0600 030	5	9	32	75	6	0.3	○	
906 0500 075 0600 050			75	6	0.5	○	786 0500 075 0600 050	32			75	6	0.5	○		
906 0600 075 0600 030	6	10		75	6	0.3	●	786 0600 075 0600 030	6	10	40	75	6	0.3	○	
906 0600 075 0600 050			75	6	0.5	○	786 0600 075 0600 050	40			75	6	0.5	○		
906 0600 075 0600 100	8	12		75	6	1	○	786 0600 075 0600 100	8	12	40	75	6	1	○	
906 0800 075 0800 030			75	8	0.3	○	786 0800 075 0800 030	40			75	8	0.3	○		
906 0800 075 0800 050	10	14		75	8	0.5	○	786 0800 075 0800 050	10	14	40	75	8	0.5	○	
906 0800 075 0800 100			75	8	1	○	786 0800 075 0800 100	40			75	8	1	○		
906 1000 075 1000 050	12	16		75	10	0.5	○	786 1000 075 1000 050	12	16	40	75	10	0.5	○	
906 1000 075 1000 100			75	10	1	○	786 1000 075 1000 100	40			75	10	1	○		
906 1000 075 1000 200	16	22		75	10	2	○	786 1000 075 1000 200	16	22	40	75	10	2	○	
906 1000 100 1000 050			100	10	0.5	○	786 1000 100 1000 050 *	60			100	10	0.5	○		
906 1000 100 1000 100	12	16		100	10	1	○	786 1000 100 1000 100 *	12	16	60	100	10	1	○	
906 1000 100 1000 200			100	10	2	○	786 1000 100 1000 200 *	60			100	10	2	○		
906 1200 100 1200 050	16	22		100	12	0.5	○	786 1200 100 1200 050	16	22	60	100	12	0.5	○	
906 1200 100 1200 100			100	12	1	●	786 1200 100 1200 100	60			100	12	1	○		
906 1200 100 1200 200	16	22		100	12	2	○	786 1200 100 1200 200	16	22	60	100	12	2	○	
906 1600 125 1600 050			125	16	0.5	○	786 1600 125 1600 050	85			125	16	0.5	○		
906 1600 125 1600 100	12	16		125	16	1	○	786 1600 125 1600 100	12	16	85	125	16	1	○	
906 1600 125 1600 200			125	16	2	○	786 1600 125 1600 200	85			125	16	2	○		
906 1600 125 1600 300				125	16	3	○	786 1600 125 1600 300				85	125	16	3	○

Order Number	Dimension (mm)						B0909	Order Number	Dimension (mm)						B0909	
	D	l1	l2	L	d2 (h6)	R			D	l1	l2	L	d2 (h6)	R		
A28 0200 075 0600 030	2	4		75	6	0.3	○	A99 0200 075 0600 030 *	2	4	30	75	6	0.3	○	
A28 0300 075 0600 030	3	5		75	6	0.3	○	A99 0300 075 0600 030	3	5	30	75	6	0.3	●	
A28 0300 075 0600 050			75	6	0.5	○	A99 0300 075 0600 050	30			75	6	0.5	○		
A28 0400 075 0600 030	4	8		75	6	0.3	○	A99 0400 075 0600 030	4	8	32	75	6	0.3	○	
A28 0400 075 0600 050			75	6	0.5	●	A99 0400 075 0600 050	32			75	6	0.5	○		
A28 0500 075 0600 030	5	9		75	6	0.3	○	A99 0500 075 0600 030	5	9	32	75	6	0.3	○	
A28 0500 075 0600 050			75	6	0.5	○	A99 0500 075 0600 050	32			75	6	0.5	○		
A28 0600 075 0600 030	6	10		75	6	0.3	○	A99 0600 075 0600 030	6	10	40	75	6	0.3	○	
A28 0600 075 0600 050			75	6	0.5	○	A99 0600 075 0600 050	40			75	6	0.5	●		
A28 0600 075 0600 100	8	12		75	6	1	●	A99 0600 075 0600 100	8	12	40	75	6	1	●	
A28 0800 075 0800 030			75	8	0.3	●	A99 0800 075 0800 030	40			75	8	0.3	○		
A28 0800 075 0800 050	10	14		75	8	0.5	○	A99 0800 075 0800 050	10	14	40	75	8	0.5	○	
A28 0800 075 0800 100			75	8	1	○	A99 0800 075 0800 100	40			75	8	1	○		
A28 1000 075 1000 050	12	16		75	10	0.5	●	A99 1000 075 1000 050	12	16	40	75	10	0.5	●	
A28 1000 075 1000 100			75	10	1	○	A99 1000 075 1000 100	40			75	10	1	●		
A28 1000 075 1000 200	16	22		75	10	2	○	A99 1000 075 1000 200	16	22	40	75	10	2	●	
A28 1000 100 1000 050			100	10	0.5	●	A99 1000 100 1000 050 *	60			100	10	0.5	○		
A28 1000 100 1000 100	12	16		100	10	1	○	A99 1000 100 1000 100 *	12	16	60	100	10	1	○	
A28 1000 100 1000 200			100	10	2	●	A99 1000 100 1000 200 *	60			100	10	2	●		
A28 1200 100 1200 050	16	22		100	12	0.5	○	A99 1200 100 1200 050	16	22	60	100	12	0.5	○	
A28 1200 100 1200 100			100	12	1	○	A99 1200 100 1200 100	60			100	12	1	●		
A28 1200 100 1200 200	16	22		100	12	2	○	A99 1200 100 1200 200	16	22	60	100	12	2	○	
A28 1600 125 1600 050			125	16	0.5	○	A99 1600 125 1600 050	85			125	16	0.5	○		
A28 1600 125 1600 100	12	16		125	16	1	○	A99 1600 125 1600 100	12	16	85	125	16	1	●	
A28 1600 125 1600 200			125	16	2	○	A99 1600 125 1600 200	85			125	16	2	●		
A28 1600 125 1600 300				125	16	3	○	A99 1600 125 1600 300				85	125	16	3	○

* - DIN 6535

Material Group | Material-Gruppe | Groupe Matiere | Gruppo Materiali | 材质主类

Cutting Parameter

N01	N02	N03	K01	K02	P01	P02	P03	M01	M02	S01	S02	S03	H01	H02	O01	O02	224
-----	-----	-----	-----	-----	-----	-----	-----	-----	-----	-----	-----	-----	-----	-----	-----	-----	-----

907 / 813 / A29 / A1B



SE 45R TORUS SHORT FLUTES LONG REACH ENDMILLS - LONG / WITH RECESS, 4 FLUTES

- VHM SE 45R LONG REACH Torusfräser, lang, kurze Nuten, 4 Zähne
- Frese toroidali lunghe SE 45 long-reach, taglianti corti, 4 taglianti
- Fraises SE 45 LONG REACH toriques longues, dents courtes, 4 dents
- 整体硬质合金 SE 45R 系列 4刃长型长颈短刃圆鼻铣刀

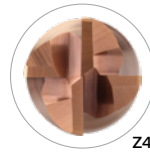

Order Number	Dimension (mm)						B0819	Order Number	Dimension (mm)						B0819		
	D	I1	I2	L	d2 (h6)	R			D	I1	I2	L	d2 (h6)	R			
907 0200 075 0600 020	2	4		75	6	0.2	°	813 0200 075 0600 020 *	2	4		30	75	6	0.2	°	•
907 0200 075 0600 030				75	6	0.3	°	813 0200 075 0600 030 *				30	75	6	0.3	°	
907 0300 075 0600 020	3	5		75	6	0.2	°	813 0300 075 0600 020	3	5		30	75	6	0.2	°	•
907 0300 075 0600 030				75	6	0.3	°	813 0300 075 0600 030				30	75	6	0.3	°	
907 0300 075 0600 050	3	5		75	6	0.5	°	813 0300 075 0600 050	3	5		30	75	6	0.5	°	•
907 0400 075 0600 020				75	6	0.2	°	813 0400 075 0600 020				32	75	6	0.2	°	
907 0400 075 0600 030	4	8		75	6	0.3	°	813 0400 075 0600 030	4	8		32	75	6	0.3	°	•
907 0400 075 0600 050				75	6	0.5	°	813 0400 075 0600 050				32	75	6	0.5	°	
907 0500 075 0600 020	5	9		75	6	0.2	°	813 0500 075 0600 020	5	9		32	75	6	0.2	°	•
907 0500 075 0600 030				75	6	0.3	°	813 0500 075 0600 030				32	75	6	0.3	°	
907 0500 075 0600 050	5	9		75	6	0.5	°	813 0500 075 0600 050	5	9		32	75	6	0.5	°	•
907 0600 075 0600 020				75	6	0.2	°	813 0600 075 0600 020				40	75	6	0.2	°	
907 0600 075 0600 030	6	10		75	6	0.3	•	813 0600 075 0600 030	6	10		40	75	6	0.3	°	•
907 0600 075 0600 050				75	6	0.5	°	813 0600 075 0600 050				40	75	6	0.5	°	
907 0600 075 0600 100	6	10		75	6	1	•	813 0600 075 0600 100	6	10		40	75	6	1	•	•
907 0800 075 0800 020				75	8	0.2	°	813 0800 075 0800 020				40	75	8	0.2	°	
907 0800 075 0800 030	8	12		75	8	0.3	°	813 0800 075 0800 030	8	12		40	75	8	0.3	°	•
907 0800 075 0800 050				75	8	0.5	•	813 0800 075 0800 050				40	75	8	0.5	•	
907 0800 075 0800 100	8	12		75	8	1	•	813 0800 075 0800 100	8	12		40	75	8	1	•	•
907 1000 075 1000 020				75	10	0.2	°	813 1000 075 1000 020				40	75	10	0.2	°	
907 1000 075 1000 030	10	14		75	10	0.3	°	813 1000 075 1000 030	10	14		40	75	10	0.3	°	•
907 1000 075 1000 050				75	10	0.5	°	813 1000 075 1000 050				40	75	10	0.5	°	
907 1000 075 1000 100	10	14		75	10	1	°	813 1000 075 1000 100	10	14		40	75	10	1	°	•
907 1000 075 1000 200				75	10	2	°	813 1000 075 1000 200				40	75	10	2	°	
907 1000 100 1000 020	10	14		100	10	0.2	°	813 1000 100 1000 020 *	10	14		60	100	10	0.2	°	•
907 1000 100 1000 030				100	10	0.3	°	813 1000 100 1000 030 *				60	100	10	0.3	°	
907 1000 100 1000 050	10	14		100	10	0.5	•	813 1000 100 1000 050 *	10	14		60	100	10	0.5	•	•
907 1000 100 1000 100				100	10	1	•	813 1000 100 1000 100 *				60	100	10	1	•	
907 1000 100 1000 200	10	14		100	10	2	•	813 1000 100 1000 200 *	10	14		60	100	10	2	•	•
907 1200 100 1200 020				100	10	0.2	°	813 1200 100 1200 020				60	100	10	0.2	°	
907 1200 100 1200 030	12	16		100	12	0.3	°	813 1200 100 1200 030	12	16		60	100	12	0.3	°	•
907 1200 100 1200 050				100	12	0.5	•	813 1200 100 1200 050				60	100	12	0.5	•	
907 1200 100 1200 100	12	16		100	12	1	•	813 1200 100 1200 100	12	16		60	100	12	1	•	•
907 1200 100 1200 200				100	12	2	°	813 1200 100 1200 200				60	100	12	2	•	
907 1600 125 1600 030	16	22		125	16	0.3	°	813 1600 125 1600 030	16	22		85	125	16	0.3	°	•
907 1600 125 1600 050				125	16	0.5	•	813 1600 125 1600 050				85	125	16	0.5	•	
907 1600 125 1600 100	16	22		125	16	1	•	813 1600 125 1600 100	16	22		85	125	16	1	•	•
907 1600 125 1600 200				125	16	2	°	813 1600 125 1600 200				85	125	16	2	•	
907 1600 125 1600 300	16	22		125	16	3	•	813 1600 125 1600 300	16	22		85	125	16	3	°	•

* - DIN 6535

cont'd ▶

Material Group | Material-Gruppe | Groupe Matière | Gruppo Materiali | 材质主类

Cutting Parameter

N01	N02	N03	K01	K02	P01	P02	P03	M01	M02	S01	S02	S03	H01	H02	O01	O02
-----	-----	-----	-----	-----	-----	-----	-----	-----	-----	-----	-----	-----	-----	-----	-----	-----

224

SE 45R TORUS SHORT FLUTES LONG REACH ENDMILLS - LONG / WITH RECESS, 4 FLUTES

- VHM SE 45R LONG REACH Torusfräser, lang, kurze Nuten, 4 Zähne
- Frese toroidali lunghe SE 45 long-reach, taglienti corti, 4 taglienti
- Fraises SE 45 LONG REACH toriques longues, dents courtes, 4 dents
- 整体硬质合金 SE 45R 系列 4刃长型长颈短刃圆鼻铣刀

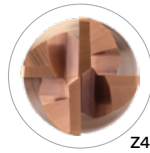

Order Number	Dimension (mm)						B0909	Order Number	Dimension (mm)						B0909	
	D	I 1	I 2	L	d2 (h6)	R			D	I 1	I 2	L	d2 (h6)	R		
A29 0200 075 0600 020	2	4		75	6	0.2	○	A1B 0200 075 0600 020 *	2	4	30	75	6	0.2	○	
A29 0200 075 0600 030				75	6	0.3	●	A1B 0200 075 0600 030 *				30	75	6	0.3	○
A29 0300 075 0600 020	3	5		75	6	0.2	○	A1B 0300 075 0600 020	3	5	30	75	6	0.2	○	
A29 0300 075 0600 030				75	6	0.3	●	A1B 0300 075 0600 030				30	75	6	0.3	●
A29 0300 075 0600 050				75	6	0.5	○	A1B 0300 075 0600 050				30	75	6	0.5	○
A29 0400 075 0600 020	4	8		75	6	0.2	○	A1B 0400 075 0600 020	4	8	32	75	6	0.2	○	
A29 0400 075 0600 030				75	6	0.3	○	A1B 0400 075 0600 030				32	75	6	0.3	●
A29 0400 075 0600 050				75	6	0.5	●	A1B 0400 075 0600 050				32	75	6	0.5	○
A29 0500 075 0600 020	5	9		75	6	0.2	○	A1B 0500 075 0600 020	5	9	32	75	6	0.2	○	
A29 0500 075 0600 030				75	6	0.3	●	A1B 0500 075 0600 030				32	75	6	0.3	●
A29 0500 075 0600 050				75	6	0.5	○	A1B 0500 075 0600 050				32	75	6	0.5	●
A29 0600 075 0600 020	6	10		75	6	0.2	○	A1B 0600 075 0600 020	6	10	40	75	6	0.2	○	
A29 0600 075 0600 030				75	6	0.3	○	A1B 0600 075 0600 030				40	75	6	0.3	○
A29 0600 075 0600 050				75	6	0.5	●	A1B 0600 075 0600 050				40	75	6	0.5	○
A29 0800 075 0800 100	8	12		75	6	1	●	A1B 0800 075 0800 100	8	12	40	75	6	1	●	
A29 0800 075 0800 020				75	8	0.2	●	A1B 0800 075 0800 020				40	75	8	0.2	○
A29 0800 075 0800 030				75	8	0.3	○	A1B 0800 075 0800 030				40	75	8	0.3	○
A29 0800 075 0800 050		75	8	0.5	●	A1B 0800 075 0800 050		40	75	8	0.5	●				
A29 0800 075 0800 100		75	8	1	●	A1B 0800 075 0800 100		40	75	8	1	●				
A29 1000 075 1000 020	10	14		75	10	0.2	○	A1B 1000 075 1000 020	10	14	40	75	10	0.2	○	
A29 1000 075 1000 030				75	10	0.3	○	A1B 1000 075 1000 030				40	75	10	0.3	○
A29 1000 075 1000 050				75	10	0.5	●	A1B 1000 075 1000 050				40	75	10	0.5	●
A29 1000 075 1000 100		75	10	1	●	A1B 1000 075 1000 100		40	75	10	1	○				
A29 1000 075 1000 200		75	10	2	○	A1B 1000 075 1000 200		40	75	10	2	○				
A29 1000 100 1000 020		100	10	0.2	○	A1B 1000 100 1000 020 *		60	100	10	0.2	○				
A29 1000 100 1000 030		100	10	0.3	○	A1B 1000 100 1000 030 *		60	100	10	0.3	○				
A29 1000 100 1000 050		100	10	0.5	●	A1B 1000 100 1000 050 *		60	100	10	0.5	●				
A29 1000 100 1000 100		100	10	1	●	A1B 1000 100 1000 100 *		60	100	10	1	●				
A29 1000 100 1000 200		100	10	2	○	A1B 1000 100 1000 200 *		60	100	10	2	○				
A29 1200 100 1200 020	12	16		100	12	0.2	○	A1B 1200 100 1200 020	12	16	60	100	12	0.2	○	
A29 1200 100 1200 030				100	12	0.3	○	A1B 1200 100 1200 030				60	100	12	0.3	○
A29 1200 100 1200 050				100	12	0.5	○	A1B 1200 100 1200 050				60	100	12	0.5	●
A29 1200 100 1200 100		100	12	1	●	A1B 1200 100 1200 100		60	100	12	1	●				
A29 1200 100 1200 200		100	12	2	●	A1B 1200 100 1200 200		60	100	12	2	●				
A29 1600 125 1600 030	16	22		125	16	0.3	○	A1B 1600 125 1600 030	16	22	85	125	16	0.3	○	
A29 1600 125 1600 050				125	16	0.5	○	A1B 1600 125 1600 050				85	125	16	0.5	○
A29 1600 125 1600 100				125	16	1	●	A1B 1600 125 1600 100				85	125	16	1	●
A29 1600 125 1600 200		125	16	2	●	A1B 1600 125 1600 200		85	125	16	2	●				
A29 1600 125 1600 300		125	16	3	○	A1B 1600 125 1600 300		85	125	16	3	○				

* - DIN 6535

Material Group | Material-Gruppe | Groupe Matière | Gruppo Materiali | 材质主类

Cutting Parameter

N01	N02	N03	K01	K02	P01	P02	P03	M01	M02	S01	S02	S03	H01	H02	O01	O02	224
-----	-----	-----	-----	-----	-----	-----	-----	-----	-----	-----	-----	-----	-----	-----	-----	-----	-----

908 / B32 / A30 / A31



SE 45R TORUS SHORT FLUTES LONG REACH ENDMILLS - EXTRA-LONG / WITH RECESS, 2 FLUTE

- VHM SE 45R LONG REACH Torusfräser, extra-lang, kurze Nuten, 2 Zähne
- Frese toroidali extra-lunghe SE 45 long-reach, taglienti corti, 2 taglienti
- Fraises SE 45 LONG REACH toriques extra-longues, dents courtes, 2 dents
- 整体硬质合金 SE 45R 系列 2刃加长型长颈短刃圆鼻铣刀

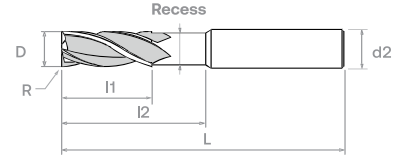
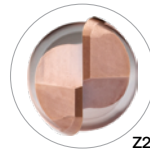

Order Number	Dimension (mm)						B0819
	D	l1	l2	L	d2 (h6)	R	
908 0200 100 0600 030	2	4		100	6	0.3	°
908 0300 100 0600 030				100	6	0.3	°
908 0300 100 0600 050	3	5		100	6	0.5	°
908 0400 100 0600 030				100	6	0.3	°
908 0400 100 0600 050	4	8		100	6	0.5	°
908 0500 100 0600 030				100	6	0.3	°
908 0500 100 0600 050	5	9		100	6	0.5	°
908 0600 100 0600 030				100	6	0.3	°
908 0600 100 0600 050	6	10		100	6	0.5	°
908 0800 100 0600 100				100	6	1	°
908 0800 100 0800 030				100	8	0.3	°
908 0800 100 0800 050	8	12		100	8	0.5	°
908 0800 100 0800 100				100	8	1	•
908 1000 125 1000 050				125	10	0.5	°
908 1000 125 1000 100	10	14		125	10	1	°
908 1000 125 1000 200				125	10	2	°
908 1200 150 1200 050				150	12	0.5	°
908 1200 150 1200 100	12	16		150	12	1	°
908 1200 150 1200 200				150	12	2	°
908 1600 150 1600 050				150	16	0.5	°
908 1600 150 1600 100	16	22		150	16	1	°
908 1600 150 1600 200				150	16	2	°
908 1600 150 1600 300				150	16	3	°

Order Number	Dimension (mm)						B0819
	D	l1	l2	L	d2 (h6)	R	
B32 0200 100 0600 030	2	4	60	100	6	0.3	°
B32 0300 100 0600 030			60	100	6	0.3	°
B32 0300 100 0600 050	3	5	60	100	6	0.5	°
B32 0400 100 0600 030 *			60	100	6	0.3	°
B32 0400 100 0600 050 *	4	8	60	100	6	0.5	°
B32 0500 100 0600 030			60	100	6	0.3	°
B32 0500 100 0600 050	5	9	60	100	6	0.5	°
B32 0600 100 0600 030			60	100	6	0.3	°
B32 0600 100 0600 050	6	10	60	100	6	0.5	°
B32 0600 100 0800 100			60	100	6	1	°
B32 0800 100 0800 030			60	100	8	0.3	°
B32 0800 100 0800 050	8	12	60	100	8	0.5	°
B32 0800 100 0800 100			60	100	8	1	°
B32 1000 125 1000 050 *			85	125	10	0.5	°
B32 1000 125 1000 100 *	10	14	85	125	10	1	°
B32 1000 125 1000 200 *			85	125	10	2	°
B32 1200 150 1200 050			110	150	12	0.5	°
B32 1200 150 1200 100	12	16	110	150	12	1	°
B32 1200 150 1200 200			110	150	12	2	°
B32 1600 150 1600 050			110	150	16	0.5	°
B32 1600 150 1600 100	16	22	110	150	16	1	°
B32 1600 150 1600 200			110	150	16	2	°
B32 1600 150 1600 300			110	150	16	3	°

Order Number	Dimension (mm)						B0819
	D	l1	l2	L	d2 (h6)	R	
A30 0200 100 0600 030	2	4		100	6	0.3	°
A30 0300 100 0600 030				100	6	0.3	°
A30 0300 100 0600 050	3	5		100	6	0.5	°
A30 0400 100 0600 030				100	6	0.3	°
A30 0400 100 0600 050	4	8		100	6	0.5	°
A30 0500 100 0600 030				100	6	0.3	°
A30 0500 100 0600 050	5	9		100	6	0.5	°
A30 0600 100 0600 030				100	6	0.3	°
A30 0600 100 0600 050	6	10		100	6	0.5	•
A30 0600 100 0600 100				100	6	1	•
A30 0800 100 0800 030				100	8	0.3	°
A30 0800 100 0800 050	8	12		100	8	0.5	•
A30 0800 100 0800 100				100	8	1	°
A30 1000 125 1000 050				125	10	0.5	°
A30 1000 125 1000 100	10	14		125	10	1	°
A30 1000 125 1000 200				125	10	2	°
A30 1200 150 1200 050				150	12	0.5	°
A30 1200 150 1200 100	12	16		150	12	1	°
A30 1200 150 1200 200				150	12	2	°
A30 1600 150 1600 050				150	16	0.5	°
A30 1600 150 1600 100	16	22		150	16	1	°
A30 1600 150 1600 200				150	16	2	°
A30 1600 150 1600 300				150	16	3	°

Order Number	Dimension (mm)						B0909
	D	l1	l2	L	d2 (h6)	R	
A31 0200 100 0600 030	2	4	60	100	6	0.3	°
A31 0300 100 0600 030			60	100	6	0.3	°
A31 0300 100 0600 050	3	5	60	100	6	0.5	°
A31 0400 100 0600 030 *			60	100	6	0.3	°
A31 0400 100 0600 050 *	4	8	60	100	6	0.5	•
A31 0500 100 0600 030			60	100	6	0.3	•
A31 0500 100 0600 050	5	9	60	100	6	0.5	°
A31 0600 100 0600 030			60	100	6	0.3	°
A31 0600 100 0600 050	6	10	60	100	6	0.5	°
A31 0600 100 0600 100			60	100	6	1	•
A31 0800 100 0800 030			60	100	8	0.3	°
A31 0800 100 0800 050	8	12	60	100	8	0.5	•
A31 0800 100 0800 100			60	100	8	1	•
A31 1000 125 1000 050 *			85	125	10	0.5	°
A31 1000 125 1000 100 *	10	14	85	125	10	1	°
A31 1000 125 1000 200 *			85	125	10	2	•
A31 1200 150 1200 050			110	150	12	0.5	•
A31 1200 150 1200 100	12	16	110	150	12	1	•
A31 1200 150 1200 200			110	150	12	2	•
A31 1600 150 1600 050			110	150	16	0.5	°
A31 1600 150 1600 100	16	22	110	150	16	1	°
A31 1600 150 1600 200			110	150	16	2	°
A31 1600 150 1600 300			110	150	16	3	°

* - DIN 6535

Material Group | Material-Gruppe | Groupe Matière | Gruppo Materiali | 材质主类

Cutting Parameter

N01	N02	N03	K01	K02	P01	P02	P03	M01	M02	S01	S02	S03	H01	H02	O01	O02
-----	-----	-----	-----	-----	-----	-----	-----	-----	-----	-----	-----	-----	-----	-----	-----	-----

224

ALL LINE
EZ LINE -
ENDMILL
SE 30
NITICO 30
OPTIMUM
SE 45
SE 45X
NITICO 45
SE 60
SE 60X
DN70 -
SE 70
SE GR
TE 45
PLUNGE
-MILL
THREAD
MILL

SE 45R TORUS SHORT FLUTES LONG REACH ENDMILLS - EXTRA-LONG / WITH RECESS, 4 FLUTE

- VHM SE 45R LONG REACH Torusfräser, extra-lang, kurze Nuten, 4 Zähne
- Frese toroidali extra-lunghe SE 45 long-reach, taglianti corti, 4 taglianti
- Fraises SE 45 LONG REACH toriques extra-longues, dents courtes, 4 dents
- 整体硬质合金 SE 45R 系列 4刃加长型长颈短刃圆鼻铣刀



Order Number	Dimension (mm)						B0819	Order Number	Dimension (mm)						B0819		
	D	I1	I2	L	d2(h6)	R			D	I1	I2	L	d2(h6)	R			
909 0200 100 0600 020	2	4		100	6	0.2	°	B33 0200 100 0600 020	2	4		60	100	6	0.2	°	B33 0200 100 0600 030
909 0200 100 0600 030				100	6	0.3	°	B33 0300 100 0600 020				60	100	6	0.3	°	B33 0300 100 0600 030
909 0300 100 0600 020	3	5		100	6	0.2	°	B33 0300 100 0600 030	3	5		60	100	6	0.2	°	B33 0300 100 0600 050
909 0300 100 0600 030				100	6	0.3	°	B33 0400 100 0600 100				60	100	6	0.5	°	B33 0400 100 0600 100
909 0300 100 0600 050	4	8		100	6	1	°	B33 0400 100 0600 020 *	4	8		60	100	6	1	°	B33 0400 100 0600 030 *
909 0400 100 0600 100				100	6	0.2	°	B33 0500 100 0600 020				60	100	6	0.2	°	B33 0500 100 0600 030
909 0400 100 0600 020	5	9		100	6	0.3	°	B33 0400 100 0600 050 *	5	9		60	100	6	0.3	°	B33 0400 100 0600 100 *
909 0400 100 0600 030				100	6	0.5	°	B33 0500 100 0600 030				60	100	6	0.5	°	B33 0500 100 0600 050
909 0500 100 0600 020	6	10		100	6	1	°	B33 0400 100 0600 100 *	6	10		60	100	6	1	°	B33 0500 100 0600 100
909 0500 100 0600 030				100	6	0.2	°	B33 0600 100 0600 020				60	100	6	0.2	°	B33 0600 100 0600 030
909 0500 100 0600 050	8	12		100	6	0.3	°	B33 0600 100 0600 030	8	12		60	100	6	0.3	°	B33 0600 100 0600 050
909 0600 100 0600 020				100	6	0.5	°	B33 0600 100 0600 100				60	100	6	0.5	°	B33 0800 100 0800 020
909 0600 100 0600 030	10	14		100	6	1	°	B33 0600 125 0600 020	10	14		60	100	6	1	°	B33 0800 100 0800 030
909 0600 125 0600 020				125	6	0.2	°	B33 0600 125 0600 030				60	100	8	0.2	°	B33 0800 100 0800 050
909 0600 125 0600 030	12	16		125	6	0.3	°	B33 0600 125 0600 050	12	16		60	125	6	0.3	°	B33 0800 125 0800 020
909 0600 125 0600 050				125	6	0.5	°	B33 0600 125 0600 100				60	125	6	0.5	°	B33 0800 125 0800 030
909 0800 100 0800 020	16	22		125	6	1	°	B33 0800 100 0800 100	16	22		60	125	6	1	°	B33 0800 125 0800 050
909 0800 100 0800 030				100	8	0.2	°	B33 0800 100 0800 200				60	125	8	0.2	°	B33 0800 125 0800 100
909 0800 100 0800 050	10	14		100	8	0.3	°	B33 0800 125 0800 020	10	14		60	125	8	0.3	°	B33 0800 125 0800 200
909 0800 100 0800 100				100	8	0.5	°	B33 0800 125 0800 030				60	125	8	0.5	°	B33 1000 125 1000 020 *
909 0800 100 0800 200	12	16		100	8	1	°	B33 0800 125 0800 050	12	16		60	125	8	1	°	B33 1000 125 1000 030 *
909 0800 125 0800 020				125	8	0.2	°	B33 0800 125 0800 100				85	125	10	0.2	°	B33 1000 125 1000 050 *
909 0800 125 0800 030	16	22		125	8	0.3	°	B33 0800 125 0800 200	16	22		60	125	8	0.3	°	B33 1000 125 1000 100 *
909 0800 125 0800 050				125	8	0.5	°	B33 1000 125 1000 200				85	125	10	0.5	°	B33 1000 125 1000 200 *
909 0800 125 0800 100	10	14		125	8	1	°	B33 1000 125 1000 020 *	10	14		60	125	8	1	°	B33 1000 150 1000 020
909 0800 125 0800 200				125	8	2	°	B33 1000 125 1000 030				60	125	8	2	°	B33 1000 150 1000 030
909 1000 125 1000 020	12	16		125	10	0.2	°	B33 1000 125 1000 050 *	12	16		85	125	10	0.2	°	B33 1000 150 1000 050
909 1000 125 1000 030				125	10	0.3	°	B33 1000 125 1000 100 *				85	125	10	0.3	°	B33 1000 150 1000 100
909 1000 125 1000 050	16	22		125	10	0.5	°	B33 1000 125 1000 200 *	16	22		85	125	10	0.5	°	B33 1000 150 1000 200
909 1000 150 1000 020				150	10	0.2	°	B33 1200 150 1200 020				85	150	10	0.2	°	B33 1200 150 1200 030
909 1000 150 1000 030	10	14		150	10	0.3	°	B33 1000 150 1000 050	10	14		85	150	10	0.3	°	B33 1200 150 1200 050
909 1000 150 1000 050				150	10	0.5	°	B33 1000 150 1000 100				85	150	10	0.5	°	B33 1200 150 1200 100
909 1000 150 1000 100	12	16		150	10	1	°	B33 1000 150 1000 200	12	16		85	150	10	1	°	B33 1200 150 1200 200
909 1000 150 1000 200				150	10	2	°	B33 1000 150 1000 020				85	150	10	2	°	B33 1600 150 1600 020
909 1200 150 1200 020	16	22		150	12	0.2	°	B33 1000 150 1000 030	16	22		110	150	12	0.2	°	B33 1600 150 1600 030
909 1200 150 1200 030				150	12	0.3	°	B33 1000 150 1000 050				110	150	12	0.3	°	B33 1600 150 1600 050
909 1200 150 1200 050	10	14		150	12	0.5	°	B33 1000 150 1000 100	10	14		110	150	12	0.5	°	B33 1600 150 1600 100
909 1200 150 1200 100				150	12	1	°	B33 1000 150 1000 200				110	150	12	1	°	B33 1600 150 1600 200
909 1200 150 1200 200	16	22		150	12	2	°	B33 1000 150 1000 020	16	22		110	150	12	2	°	B33 1600 150 1600 300
909 1600 150 1600 030				150	16	0.3	°	B33 1200 150 1200 020				110	150	16	0.3	°	
909 1600 150 1600 050	12	16		150	16	0.5	°	B33 1200 150 1200 030	12	16		110	150	16	0.5	°	
909 1600 150 1600 100				150	16	1	°	B33 1200 150 1200 050				110	150	16	1	°	
909 1600 150 1600 200	16	22		150	16	2	°	B33 1200 150 1200 100	16	22		110	150	16	2	°	
909 1600 150 1600 300				150	16	3	°	B33 1600 150 1600 020				110	150	16	3	°	

* - DIN 6535

cont'd ▶

Material Group | Material-Gruppe | Groupe Matière | Gruppo Materiali | 材质主类

Cutting Parameter

N01	N02	N03	K01	K02	P01	P02	P03	M01	M02	S01	S02	S03	H01	H02	O01	O02	225
-----	-----	-----	-----	-----	-----	-----	-----	-----	-----	-----	-----	-----	-----	-----	-----	-----	-----

SE 45R TORUS SHORT FLUTES LONG REACH ENDMILLS - EXTRA-LONG / WITH RECESS, 4 FLUTE

- VHM SE 45R LONG REACH Torusfräser, extra-lang, kurze Nuten, 4 Zähne
- Frese toroidali extra-lunghe SE 45 long-reach, taglienti corti, 4 taglienti
- Fraises SE 45 LONG REACH toriques extra-longues, dents courtes, 4 dents
- 整体硬质合金 SE 45R 系列 4刃加长型长颈短刃圆鼻铣刀

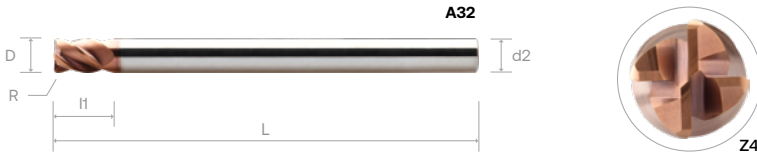

Order Number	Dimension (mm)						B0909	Order Number	Dimension (mm)						B0909	
	D	I1	I2	L	d2 (h6)	R			D	I1	I2	L	d2 (h6)	R		
A32 0200 100 0600 020	2	4		100	6	0.2	°	A33 0200 100 0600 020	2	4	60	100	6	0.2	°	°
A32 0200 100 0600 030				100	6	0.3	°	A33 0200 100 0600 030			60	100	6	0.3	°	
A32 0300 100 0600 020	3	5		100	6	0.2	°	A33 0300 100 0600 020	3	5	60	100	6	0.2	°	°
A32 0300 100 0600 030				100	6	0.3	°	A33 0300 100 0600 030			60	100	6	0.3	°	
A32 0300 100 0600 050				100	6	0.5	°	A33 0300 100 0600 050			60	100	6	0.5	°	°
A32 0300 100 0600 100				100	6	1	°	A33 0300 100 0600 100			60	100	6	1	°	
A32 0400 100 0600 020	4	8		100	6	0.2	°	A33 0400 100 0600 020 *	4	8	60	100	6	0.2	°	°
A32 0400 100 0600 030				100	6	0.3	°	A33 0400 100 0600 030 *			60	100	6	0.3	°	
A32 0400 100 0600 050				100	6	0.5	°	A33 0400 100 0600 050 *			60	100	6	0.5	°	°
A32 0400 100 0600 100				100	6	1	°	A33 0400 100 0600 100 *			60	100	6	1	°	
A32 0500 100 0600 020	5	9		100	6	0.2	°	A33 0500 100 0600 020	5	9	60	100	6	0.2	°	°
A32 0500 100 0600 030				100	6	0.3	°	A33 0500 100 0600 030			60	100	6	0.3	°	
A32 0500 100 0600 050				100	6	0.5	°	A33 0500 100 0600 050			60	100	6	0.5	°	°
A32 0500 100 0600 100				100	6	1	°	A33 0500 100 0600 100			60	100	6	1	°	
A32 0600 100 0600 020	6	10		100	6	0.2	°	A33 0600 100 0600 020	6	10	60	100	6	0.2	°	°
A32 0600 100 0600 030				100	6	0.3	°	A33 0600 100 0600 030			60	100	6	0.3	°	
A32 0600 100 0600 050				100	6	0.5	°	A33 0600 100 0600 050			60	100	6	0.5	°	°
A32 0600 100 0600 100				100	6	1	°	A33 0600 100 0600 100			60	100	6	1	°	
A32 0600 125 0600 020				125	6	0.2	°	A33 0600 125 0600 020			60	125	6	0.2	°	°
A32 0600 125 0600 030				125	6	0.3	°	A33 0600 125 0600 030			60	125	6	0.3	°	
A32 0600 125 0600 050				125	6	0.5	°	A33 0600 125 0600 050			60	125	6	0.5	°	°
A32 0600 125 0600 100				125	6	1	°	A33 0600 125 0600 100			60	125	6	1	°	
A32 0800 100 0800 020	8	12		100	8	0.2	°	A33 0800 100 0800 020	8	12	60	100	8	0.2	°	°
A32 0800 100 0800 030				100	8	0.3	°	A33 0800 100 0800 030			60	100	8	0.3	°	
A32 0800 100 0800 050				100	8	0.5	°	A33 0800 100 0800 050			60	100	8	0.5	°	°
A32 0800 100 0800 100				100	8	1	°	A33 0800 100 0800 100			60	100	8	1	°	
A32 0800 100 0800 200				100	8	2	°	A33 0800 100 0800 200			60	100	8	2	°	°
A32 0800 125 0800 020				125	8	0.2	°	A33 0800 125 0800 020			60	125	8	0.2	°	
A32 0800 125 0800 030				125	8	0.3	°	A33 0800 125 0800 030			60	125	8	0.3	°	°
A32 0800 125 0800 050				125	8	0.5	°	A33 0800 125 0800 050			60	125	8	0.5	°	
A32 0800 125 0800 100				125	8	1	°	A33 0800 125 0800 100			60	125	8	1	°	°
A32 0800 125 0800 200				125	8	2	°	A33 0800 125 0800 200			60	125	8	2	°	
A32 1000 125 1000 020	10	14		125	10	0.2	°	A33 1000 125 1000 020 *	10	14	85	125	10	0.2	°	°
A32 1000 125 1000 030				125	10	0.3	°	A33 1000 125 1000 030 *			85	125	10	0.3	°	
A32 1000 125 1000 050				125	10	0.5	°	A33 1000 125 1000 050 *			85	125	10	0.5	°	°
A32 1000 125 1000 100				125	10	1	°	A33 1000 125 1000 100 *			85	125	10	1	°	
A32 1000 125 1000 200				125	10	2	°	A33 1000 125 1000 200 *			85	125	10	2	°	°
A32 1000 150 1000 020				150	10	0.2	°	A33 1000 150 1000 020			85	150	10	0.2	°	
A32 1000 150 1000 030				150	10	0.3	°	A33 1000 150 1000 030			85	150	10	0.3	°	°
A32 1000 150 1000 050				150	10	0.5	°	A33 1000 150 1000 050			85	150	10	0.5	°	
A32 1000 150 1000 100				150	10	1	°	A33 1000 150 1000 100			85	150	10	1	°	°
A32 1000 150 1000 200				150	10	2	°	A33 1000 150 1000 200			85	150	10	2	°	
A32 1200 150 1200 020	12	16		150	12	0.2	°	A33 1200 150 1200 020	12	16	110	150	12	0.2	°	°
A32 1200 150 1200 030				150	12	0.3	°	A33 1200 150 1200 030			110	150	12	0.3	°	
A32 1200 150 1200 050				150	12	0.5	°	A33 1200 150 1200 050			110	150	12	0.5	°	°
A32 1200 150 1200 100				150	12	1	°	A33 1200 150 1200 100			110	150	12	1	°	
A32 1200 150 1200 200				150	12	2	°	A33 1200 150 1200 200			110	150	12	2	°	°
A32 1600 150 1600 030	16	22		150	16	0.3	°	A33 1600 150 1600 030	16	22	110	150	16	0.3	°	
A32 1600 150 1600 050				150	16	0.5	°	A33 1600 150 1600 050			110	150	16	0.5	°	
A32 1600 150 1600 100				150	16	1	°	A33 1600 150 1600 100			110	150	16	1	°	°
A32 1600 150 1600 200				150	16	2	°	A33 1600 150 1600 200			110	150	16	2	°	
A32 1600 150 1600 300				150	16	3	°	A33 1600 150 1600 300			110	150	16	3	°	

* - DIN 6535

ALL LINE
EZ LINE -
ENDMILL
SE 30
NITICO 30
OPTIMUM
SE 45
SE 45X
NITICO 45
SE 60
SE 60X
DN70 -
SE 70
SE GR
TE 45
PLUNGE
-MILL
THREAD
MILL

Material Group | Material-Gruppe | Groupe Matière | Gruppo Materiali | 材质主类

Cutting Parameter

N01	N02	N03	K01	K02	P01	P02	P03	M01	M02	S01	S02	S03	H01	H02	O01	O02	225
-----	-----	-----	-----	-----	-----	-----	-----	-----	-----	-----	-----	-----	-----	-----	-----	-----	-----

B71 / C14 / A89 / A94



SE 45 MULTIFLUTE ENDMILLS / WITH RECESS, 6 - 8 FLUTES

- VHM SE45 Mehrzahnfräser, 6 bzw. 8 Zähne
- Frese multi-taglienti SE 45, 6 - 8 taglienti
- Fraises Multidentés SE 45, 6 respectivement 8 dents
- 整体硬质合金 SE 45 系列 ☒6-8刃多刃平底铣刀☒

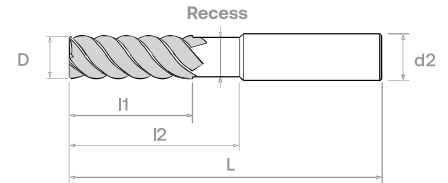
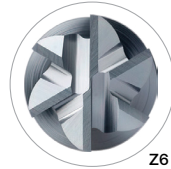
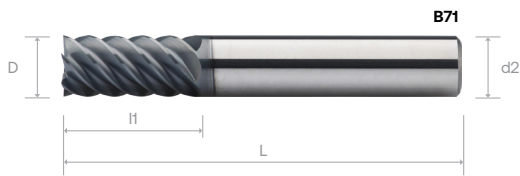

Order Number	Dimension (mm)						B0819	Order Number	Dimension (mm)						B0819
	D	I1	I2	L	d2 (h6)	Z			D	I1	I2	L	d2 (h6)	Z	
B71 0300 050 06	3	8		50	6	6	•	C14 0300 050 06	3	8	20	50	6	6	•
B71 0400 050 06	4	11		50	6	6	◦	C14 0400 050 06	4	11	20	50	6	6	•
B71 0500 050 06	5	13		50	6	6	◦	C14 0500 050 06	5	13	20	50	6	6	•
B71 0600 050	6	15		50	6	6	•	C14 0600 050	6	15	20	50	6	6	•
B71 0600 060				60	6	6	•	C14 0600 060				30	60	6	6
B71 0800	8	20		64	8	6	•	C14 0800	8	20	30	64	8	6	•
B71 1000	10			70	10	6	•	C14 1000	10	22	32	70	10	6	•
B71 1200	12	25		75	12	6	•	C14 1200	12	25	37	75	12	6	•
B71 1400	14	30		90	14	6	◦	C14 1400	14	30	44	90	14	6	◦
B71 1600	16			90	16	8	•	C14 1600	16	30	46	90	16	8	•
B71 1800	18	35		100	18	8	◦	C14 1800	18	35	53	100	18	8	◦
B71 2000	20	38		100	20	8	•	C14 2000	20	38	58	100	20	8	•

Order Number	Dimension (mm)						B0909	Order Number	Dimension (mm)						B0909
	D	I1	I2	L	d2 (h6)	Z			D	I1	I2	L	d2 (h6)	Z	
A89 0300 050 06	3	8		50	6	6	•	A94 0300 050 06	3	8	20	50	6	6	◦
A89 0400 050 06	4	11		50	6	6	•	A94 0400 050 06	4	11	20	50	6	6	◦
A89 0500 050 06	5	13		50	6	6	•	A94 0500 050 06	5	13	20	50	6	6	◦
A89 0600 050	6	15		50	6	6	•	A94 0600 050	6	15	20	50	6	6	◦
A89 0600 060				60	6	6	•	A94 0600 060				30	60	6	6
A89 0800	8	20		64	8	6	◦	A94 0800	8	20	30	64	8	6	◦
A89 1000	10			70	10	6	◦	A94 1000	10	22	32	70	10	6	◦
A89 1200	12	25		75	12	6	•	A94 1200	12	25	37	75	12	6	◦
A89 1400	14	30		90	14	6	•	A94 1400	14	30	44	90	14	6	◦
A89 1600	16			90	16	8	◦	A94 1600	16	30	46	90	16	8	◦
A89 1800	18	35		100	18	8	◦	A94 1800	18	35	53	100	18	8	◦
A89 2000	20	38		100	20	8	•	A94 2000	20	38	58	100	20	8	◦

Material Group | Material-Gruppe | Groupe Matière | Gruppo Materiali | 材质主类

Cutting Parameter

N01	N02	N03	K01	K02	P01	P02	P03	M01	M02	S01	S02	S03	H01	H02	O01	O02	225
-----	-----	-----	-----	-----	-----	-----	-----	-----	-----	-----	-----	-----	-----	-----	-----	-----	-----

ALU LINE
 EZ LINE - ENDMILL
 SE 30
 NITCo 30
 OPTIMUM
 SE 45
 SE 45X
 NITCo 45
 SE 60
 SE 60X
 DM70 - SE70
 SE GR
 TE 45
 PLUNGE -MILL
 THREAD MILL

B73 / C15 / A90 / A95



SE 45 LONG MULTIFLUTE ENDMILLS / WITH RECESS, 6 - 8 FLUTES

- VHM SE45 Mehrzahnfräser, lang, 6 bzw. 8 Zähne
- Frese multi-taglienti lunghe SE 45 lunghe, 6 - 8 taglienti
- Fraises Multidentés SE 45 longues, 6 respectivement 8 dents
- 整体硬质合金 SE 45 系列 6-8刃长型多刃平底铣刀

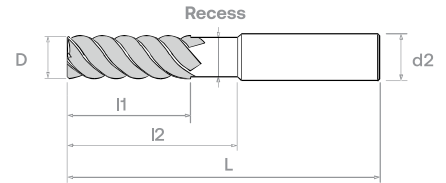
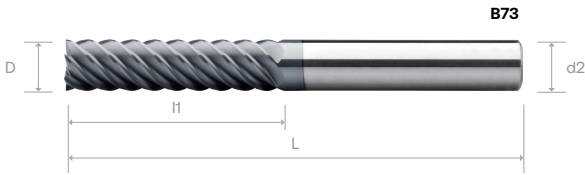
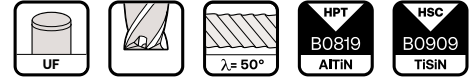

Order Number	Dimension (mm)						B0819	Order Number	Dimension (mm)						B0819
	D	l1	l2	L	d2 (h6)	Z			D	l1	l2	L	d2 (h6)	Z	
B73 0300 075 06	3	19		75	6	6	•	C15 0300 075 06	3	19	30	75	6	6	•
B73 0400 075 06	4			75	6	6	•	C15 0400 075 06	4		32	75	6	6	•
B73 0500 075 06	5			75	6	6	•	C15 0500 075 06	5		32	75	6	6	•
B73 0600	6	31		75	6	6	◦	C15 0600	6	31	40	75	6	6	•
B73 0800	8			75	8	6	•	C15 0800	8		40	75	8	6	•
B73 1000	10	45		100	10	6	•	C15 1000	10	45	60	100	10	6	•
B73 1200	12	50		100	12	6	•	C15 1200	12	50	60	100	12	6	•
B73 1400	14	57		125	14	6	•	C15 1400	14	57	85	125	14	6	•
B73 1600	16			125	16	8	•	C15 1600	16		85	125	16	8	•
B73 1800	18			125	18	8	◦	C15 1800	18		85	125	18	8	•
B73 2000	20			125	20	8	◦	C15 2000	20		85	125	20	8	•

Order Number	Dimension (mm)						B0909	Order Number	Dimension (mm)						B0909
	D	l1	l2	L	d2 (h6)	Z			D	l1	l2	L	d2 (h6)	Z	
A90 0300 075 06	3	19		75	6	6	•	A95 0300 075 06	3	19	30	75	6	6	◦
A90 0400 075 06	4			75	6	6	◦	A95 0400 075 06	4		32	75	6	6	◦
A90 0500 075 06	5			75	6	6	•	A95 0500 075 06	5		32	75	6	6	◦
A90 0600	6	31		75	6	6	•	A95 0600	6	31	40	75	6	6	◦
A90 0800	8			75	8	6	•	A95 0800	8		40	75	8	6	◦
A90 1000	10	45		100	10	6	•	A95 1000	10	45	60	100	10	6	◦
A90 1200	12	50		100	12	6	◦	A95 1200	12	50	60	100	12	6	◦
A90 1400	14	57		125	14	6	•	A95 1400	14	57	85	125	14	6	◦
A90 1600	16			125	16	8	•	A95 1600	16		85	125	16	8	◦
A90 1800	18			125	18	8	◦	A95 1800	18		85	125	18	8	◦
A90 2000	20			125	20	8	•	A95 2000	20		85	125	20	8	◦

Material Group | Material-Gruppe | Groupe Matière | Gruppo Materiali | 材质主类

N01	N02	N03	K01	K02	P01	P02	P03	M01	M02	S01	S02	S03	H01	H02	O01	O02
-----	-----	-----	-----	-----	-----	-----	-----	-----	-----	-----	-----	-----	-----	-----	-----	-----

Cutting Parameter

226

ALL LINE
 EZ LINE - ENDMILL
 SE 30
 NITICO 30
 OPTIMUM
 SE 45
 SE 45X
 NITICO 45
 SE 60
 SE 60X
 DN70 - SE 70
 SE GR
 TE 45
 PLUNGE -MILL
 THREAD MILL

B78 / C16 / A91 / A96



SE 45 EXTRA-LONG MULTIFLUTE ENDMILLS / WITH RECESS, 6 - 8 FLUTES

- VHM SE45 Mehrzahnfräser, extra-lang, 6 bzw. 8 Zähne
- Frese multi-taglienti extra-lunghe SE 45, 6 - 8 taglienti
- Fraises Multident SE 45 extra-longues, 6 respectivement 8 dents
- 整体硬质合金 SE 45 系列 6-8刃加长型多刃平底铣刀

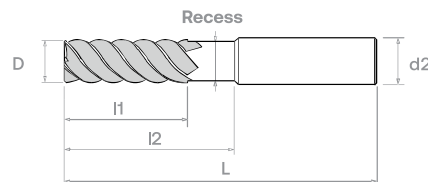
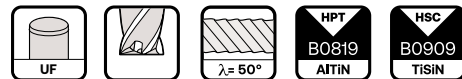

Order Number	Dimension (mm)						B0819	Order Number	Dimension (mm)						B0819	
	D	I1	I2	L	d2 (h6)	Z			D	I1	I2	L	d2 (h6)	Z		
B78 0300 100 06	3	25		100	6	6	°	C16 0300 100 06	3	25	60	100	6	6	°	
B78 0400 100 06	4	31		100	6	6	°	C16 0400 100 06 *	4	31	60	100	6	6	°	
B78 0500 100 06	5			100	6	6	°	C16 0500 100 06	5			60	100	6	6	•
B78 0600	6	38		100	6	6	°	C16 0600	6	38	60	100	6	6	•	
B78 0800	8	41		100	8	6	°	C16 0800	8	41	60	100	8	6	•	
B78 1000	10	57		125	10	6	°	C16 1000 *	10	57	85	125	10	6	°	
B78 1200	12	75		150	12	6	°	C16 1200	12	75	110	150	12	6	°	
B78 1400	14			150	14	6	°	C16 1400	14			110	150	14	6	°
B78 1600	16			150	16	8	°	C16 1600	16			110	150	16	8	•
B78 1800	18			150	18	8	°	C16 1800	18			110	150	18	8	°
B78 2000	20		150	20	8	°	C16 2000	20		110	150	20	8	•		

Order Number	Dimension (mm)						B0909	Order Number	Dimension (mm)						B0909	
	D	I1	I2	L	d2 (h6)	Z			D	I1	I2	L	d2 (h6)	Z		
A91 0300 100 06	3	25		100	6	6	°	A96 0300 100 06	3	25	60	100	6	6	°	
A91 0400 100 06	4	31		100	6	6	°	A96 0400 100 06 *	4	31	60	100	6	6	°	
A91 0500 100 06	5			100	6	6	°	A96 0500 100 06	5			60	100	6	6	°
A91 0600	6	38		100	6	6	°	A96 0600	6	38	60	100	6	6	°	
A91 0800	8	41		100	8	6	°	A96 0800	8	41	60	100	8	6	°	
A91 1000	10	57		125	10	6	°	A96 1000 *	10	57	85	125	10	6	°	
A91 1200	12	75		150	12	6	°	A96 1200	12	75	110	150	12	6	°	
A91 1400	14			150	14	6	°	A96 1400	14			110	150	14	6	°
A91 1600	16			150	16	8	•	A96 1600	16			110	150	16	8	°
A91 1800	18			150	18	8	°	A96 1800	18			110	150	18	8	°
A91 2000	20		150	20	8	•	A96 2000	20		110	150	20	8	°		

* - DIN 6535

Material Group | Material-Gruppe | Groupe Matière | Gruppo Materiali | 材质主类

Cutting Parameter

N01	N02	N03	K01	K02	P01	P02	P03	M01	M02	S01	S02	S03	H01	H02	O01	O02	226 - 227
-----	-----	-----	-----	-----	-----	-----	-----	-----	-----	-----	-----	-----	-----	-----	-----	-----	-----------

Note: These recommended cutting data indicators are just for reference. They should be adjusted according to the different cutting condition



SE 45 Standard Endmills, 2 Flutes - 886, A04, A05, B31

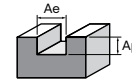

Slotting	K		P		M		S	
Working Material	Ductile Cast Iron		Prehardened steel		Stainless steel		Nickel Alloy	
Properties	-		35 ≤ HRC < 45		Low Machinability		-	
Cutting depth, ap	0.80 × D		0.80 × D		0.45 × D		0.30 × D	
Cutting Width, ae	1.00 × D		1.00 × D				1.00 × D	
D	Vc	Fz	Vc	Fz	Vc	Fz	Vc	Fz
1	65	0.003	80	0.003	40	0.002	20	0.004
2		0.006		0.006		0.004		0.008
3		0.009		0.009		0.006		0.012
4		0.012		0.012		0.010		0.018
5		0.015		0.015		0.012		0.024
6		0.018		0.018		0.016		0.028
8		0.024		0.024		0.020		0.037
10		0.030		0.030		0.024		0.045
12		0.036		0.036		0.030		0.055
14		0.042		0.042		0.035		0.066
16		0.048		0.048		0.040		0.072
18		0.054		0.054		0.045		0.082
20		0.060		0.060		0.049		0.091
22	0.066	0.066	0.055	0.100				
25	0.075	0.075	0.060	0.120				

SE 45 Standard Endmills, 2 Flutes - 886, A04, A05, B31

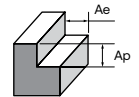

Side Milling	K		P		M		S		H	
Working Material	Ductile Cast Iron		Prehardened steel		Stainless steel		Nickel Alloy		Hardened steel	
Properties	-		35 ≤ HRC < 45		Low Machinability		-		45 ≤ HRC < 52	
Cutting depth, ap	1.00 × D		1.00 × D		1.00 × D		1.00 × D		1.00 × D	
Cutting Width, ae	0.18 × D		0.18 × D		0.18 × D		0.10 × D		0.15 × D	
D	Vc	Fz	Vc	Fz	Vc	Fz	Vc	Fz	Vc	Fz
1	75	0.004	90	0.004	45	0.005	30	0.004	75	0.003
2		0.008		0.009		0.013		0.008		0.006
3		0.011		0.014		0.020		0.012		0.009
4		0.016		0.020		0.028		0.018		0.012
5		0.020		0.028		0.038		0.024		0.015
6		0.024		0.034		0.046		0.028		0.018
8		0.032		0.046		0.060		0.037		0.024
10		0.040		0.058		0.076		0.045		0.030
12		0.048		0.069		0.090		0.055		0.036
14		0.056		0.078		0.098		0.066		0.042
16		0.064		0.088		0.108		0.072		0.048
18		0.072		0.099		0.120		0.082		0.054
20		0.080		0.105		0.132		0.091		0.060
22	0.088	0.115	0.140	0.100	0.066					
25	0.100	0.124	0.152	0.120	0.075					

ALU LINE
 EZ LINE - ENDMILL
 SE 30
 NITICO 30
 OPTIMUM
SE 45
 SE 45X
 NITICO 45
 SE 60
 SE 60X
 DN70 - SE 70
 SE GR
 TE 45
 PLUNGE -MILL
 THREAD MILL

Recommended Cutting Data



Note: These recommended cutting data indicators are just for reference. They should be adjusted according to the different cutting condition



SE 45 Standard Endmills, 4 Flutes - 311, 851, 862, 863, 887, 904, A26, B30, B59

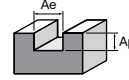

Slotting	K		P		M		S	
Working Material	Ductile Cast Iron		Prehardened steel		Stainless steel		Nickel Alloy	
Properties	-		35 ≤ HRC < 45		Low Machinability		-	
Cutting depth, ap	0.80 × D		0.80 × D		0.45 × D		0.30 × D	
Cutting Width, ae	1.00 × D		1.00 × D		1.00 × D		1.00 × D	
D	Vc	Fz	Vc	Fz	Vc	Fz	Vc	Fz
1	80	0.003	100	0.003	50	0.002	25	0.004
2		0.006		0.006		0.004		0.008
3		0.009		0.009		0.006		0.012
4		0.012		0.012		0.010		0.018
5		0.015		0.015		0.012		0.024
6		0.018		0.018		0.016		0.028
8		0.024		0.024		0.020		0.037
10		0.030		0.030		0.024		0.045
12		0.036		0.036		0.030		0.055
14		0.042		0.042		0.035		0.066
16		0.048		0.048		0.040		0.072
18		0.054		0.054		0.045		0.082
20		0.060		0.060		0.049		0.091
22		0.066		0.066		0.055		0.100
25		0.075		0.075		0.060		0.120

SE 45 Standard Endmills, 4 Flutes - 311, 851, 862, 863, 887, 904, A26, B30, B59

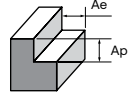

Side Milling	K		P		M		S		H	
Working Material	Ductile Cast Iron		Prehardened steel		Stainless steel		Nickel Alloy		Hardened steel	
Properties	-		35 ≤ HRC < 45		Low Machinability		-		45 ≤ HRC < 52	
Cutting depth, ap	1.00 × D		1.00 × D		1.00 × D		1.00 × D		1.00 × D	
Cutting Width, ae	0.18 × D		0.18 × D		0.18 × D		0.10 × D		0.15 × D	
D	Vc	Fz	Vc	Fz	Vc	Fz	Vc	Fz	Vc	Fz
1	90	0.004	110	0.004	55	0.005	35	0.004	90	0.003
2		0.008		0.009		0.013		0.008		0.006
3		0.012		0.014		0.020		0.012		0.009
4		0.017		0.020		0.028		0.018		0.012
5		0.022		0.028		0.038		0.024		0.015
6		0.026		0.034		0.046		0.028		0.018
8		0.034		0.046		0.060		0.037		0.024
10		0.042		0.058		0.076		0.045		0.030
12		0.051		0.069		0.090		0.055		0.036
14		0.060		0.078		0.098		0.066		0.042
16		0.068		0.088		0.108		0.072		0.048
18		0.076		0.099		0.120		0.082		0.054
20		0.084		0.105		0.132		0.091		0.060
22		0.088		0.115		0.140		0.100		0.066
25		0.100		0.124		0.152		0.120		0.075

ALU LINE
EZ LINE - ENDMILL
SE 30
NITCo 30
OPTIMUM
SE 45
SE 45X
NITCo 45
SE 60
SE 60X
DM70 - SE70
SE GR
TE 45
PLUNGE -MILL
THREAD MILL

Recommended Cutting Data



Note: These recommended cutting data indicators are just for reference. They should be adjusted according to the different cutting condition



SE 45 Long Endmills, 4 Flutes - 186, 855, 866, 867, 889, A09

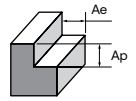

Side Milling	K		P		M		S		H	
Working Material	Ductile Cast Iron		Prehardened steel		Stainless steel		Nickel Alloy		Hardened steel	
Properties	-		35 ≤ HRC < 45		Low Machinability		-		45 ≤ HRC < 52	
Cutting depth, ap	1.50 × D		1.50 × D		1.50 × D		1.50 × D		1.50 × D	
Cutting Width, ae	0.14 × D		0.14 × D		0.14 × D		0.08 × D		0.12 × D	
D	Vc	Fz	Vc	Fz	Vc	Fz	Vc	Fz	Vc	Fz
3	80	0.011	100	0.014	45	0.018	25	0.010	80	0.007
4		0.015		0.019		0.024		0.016		0.010
5		0.019		0.026		0.031		0.021		0.013
6		0.024		0.034		0.044		0.026		0.016
8		0.032		0.046		0.058		0.035		0.022
10		0.040		0.058		0.074		0.043		0.028
12		0.048		0.069		0.088		0.052		0.034
14		0.056		0.078		0.096		0.064		0.040
16		0.064		0.088		0.106		0.070		0.046
18		0.072		0.099		0.118		0.080		0.052
20	0.080	0.105	0.130	0.088	0.058					

SE 45 Extra-Long Endmills, 4 Flutes - 202, 859, 870, 871, 891, A11

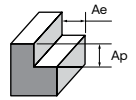

Side Milling	K		P		M		S		H	
Working Material	Ductile Cast Iron		Prehardened steel		Stainless steel		Nickel Alloy		Hardened steel	
Properties	-		35 ≤ HRC < 45		Low Machinability		-		45 ≤ HRC < 52	
Cutting depth, ap	2.00 × D		2.00 × D		2.00 × D		2.00 × D		2.00 × D	
Cutting Width, ae	0.12 × D		0.12 × D		0.12 × D		0.05 × D		0.08 × D	
D	Vc	Fz	Vc	Fz	Vc	Fz	Vc	Fz	Vc	Fz
3	70	0.010	90	0.013	35	0.016	20	0.009	70	0.006
4		0.014		0.017		0.022		0.014		0.009
5		0.017		0.023		0.028		0.019		0.012
6		0.022		0.031		0.040		0.023		0.014
8		0.029		0.041		0.052		0.032		0.020
10		0.036		0.052		0.067		0.039		0.025
12		0.043		0.062		0.079		0.047		0.031
14		0.050		0.070		0.086		0.058		0.036
16		0.058		0.079		0.095		0.063		0.041
18		0.065		0.089		0.106		0.072		0.047
20	0.072	0.095	0.117	0.079	0.052					

ALU LINE
 EZ LINE -
 ENDMILL
 SE 30
 NITICO 30
 OPTIMUM
 SE 45
 SE 45X
 NITICO 45
 SE 60
 SE 60X
 DN70 -
 SE 70
 SE GR
 TE 45
 PLUNGE
 -MILL
 THREAD
 MILL

Recommended Cutting Data



Note: These recommended cutting data indicators are just for reference. They should be adjusted according to the different cutting condition



SE 45 Short Flutes Standard Endmills, 3 Flutes - 630, 893, A14, A15

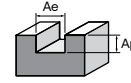

Slotting	K		P		M		S	
Working Material	Ductile Cast Iron		Prehardened steel		Stainless steel		Nickel Alloy	
Properties	-		35 ≤ HRC < 45		Low Machinability		-	
Cutting depth, ap	0.80 × D		0.80 × D		0.45 × D		0.30 × D	
Cutting Width, ae	1.00 × D		1.00 × D		1.00 × D		1.00 × D	
D	Vc	Fz	Vc	Fz	Vc	Fz	Vc	Fz
1	70	0.004	90	0.004	45	0.002	20	0.004
2		0.008		0.008		0.004		0.008
3		0.012		0.012		0.006		0.012
4		0.018		0.017		0.010		0.018
5		0.022		0.021		0.012		0.024
6		0.027		0.026		0.016		0.028
8		0.035		0.033		0.020		0.037
10		0.045		0.043		0.024		0.045
12		0.052		0.050		0.030		0.055
14		0.061		0.060		0.035		0.066
16		0.072		0.068		0.040		0.072
18		0.080		0.075		0.045		0.082
20		0.090		0.088		0.049		0.091
22		0.098		0.095		0.055		0.100
25		0.108		0.102		0.060		0.120

SE 45 Short Flutes Standard Endmills, 3 Flutes - 630, 893, A14, A15

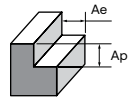

Side Milling	K		P		M		S		H	
Working Material	Ductile Cast Iron		Prehardened steel		Stainless steel		Nickel Alloy		Hardened steel	
Properties	-		35 ≤ HRC < 45		Low Machinability		-		45 ≤ HRC < 52	
Cutting depth, ap	0.32 × D		0.32 × D		0.30 × D		0.25 × D		0.30 × D	
Cutting Width, ae	0.40 × D		0.40 × D		0.40 × D		0.40 × D		0.40 × D	
D	Vc	Fz	Vc	Fz	Vc	Fz	Vc	Fz	Vc	Fz
1	80	0.004	100	0.004	50	0.005	30	0.004	80	0.003
2		0.008		0.009		0.013		0.008		
3		0.012		0.014		0.020		0.012		0.009
4		0.017		0.020		0.028		0.018		0.012
5		0.022		0.028		0.038		0.024		0.015
6		0.026		0.034		0.046		0.028		0.018
8		0.034		0.046		0.060		0.037		0.024
10		0.042		0.058		0.076		0.045		0.030
12		0.051		0.069		0.090		0.055		0.036
14		0.060		0.078		0.098		0.066		0.042
16		0.068		0.088		0.108		0.072		0.048
18		0.076		0.099		0.120		0.082		0.054
20		0.084		0.105		0.132		0.091		0.060
22		0.088		0.115		0.140		0.100		0.066
25		0.100		0.124		0.152		0.120		0.075

ALU LINE
EZ LINE - ENDMILL
SE 30
NITCo 30
OPTIMUM
SE 45
SE 45X
NITCo 45
SE 60
SE 60X
DM70 - SE70
SE GR
TE 45
PLUNGE -MILL
THREAD MILL

Recommended Cutting Data



Note: These recommended cutting data indicators are just for reference. They should be adjusted according to the different cutting condition



SE 45 Short Flutes Long Reach Long Endmills, 4 Flutes - 813, 895, 897, 907, A18, A19, A29, A1B

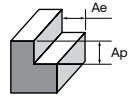

Side Milling	K		P		M		S		H	
Working Material	Ductile Cast Iron		Prehardened steel		Stainless steel		Nickel Alloy		Hardened steel	
Properties	-		35 ≤ HRC < 45		Low Machinability		-		45 ≤ HRC < 52	
Cutting depth, ap	0.27 × D		0.27 × D		0.25 × D		0.20 × D		0.25 × D	
Cutting Width, ae	0.35 × D		0.35 × D		0.35 × D		0.35 × D		0.35 × D	
D	Vc	Fz	Vc	Fz	Vc	Fz	Vc	Fz	Vc	Fz
2	90	0.007	110	0.008	50	0.011	30	0.005	90	0.004
3		0.011		0.014		0.018		0.010		0.007
4		0.015		0.019		0.024		0.016		0.010
5		0.019		0.026		0.031		0.021		0.013
6		0.024		0.034		0.044		0.026		0.016
8		0.032		0.046		0.058		0.035		0.022
10		0.040		0.058		0.074		0.043		0.028
12		0.048		0.069		0.088		0.052		0.034
14		0.056		0.078		0.096		0.064		0.040
16		0.064		0.088		0.106		0.070		0.046

SE 45R Short Flutes Long Reach Torus Long Endmills, 2 Flutes - 786, 906, 908, A28, A30, A31, A99, B32

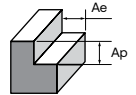

Side Milling	K		P		M		S		H	
Working Material	Ductile Cast Iron		Prehardened steel		Stainless steel		Nickel Alloy		Hardened steel	
Properties	-		35 ≤ HRC < 45		Low Machinability		-		45 ≤ HRC < 52	
Cutting depth, ap	0.27 × D		0.27 × D		0.25 × D		0.20 × D		0.25 × D	
Cutting Width, ae	0.35 × D		0.35 × D		0.35 × D		0.35 × D		0.35 × D	
D	Vc	Fz	Vc	Fz	Vc	Fz	Vc	Fz	Vc	Fz
2	75	0.007	90	0.008	40	0.011	25	0.005	75	0.004
3		0.011		0.014		0.018		0.010		0.007
4		0.015		0.019		0.024		0.016		0.010
5		0.019		0.026		0.031		0.021		0.013
6		0.024		0.034		0.044		0.026		0.016
8		0.032		0.046		0.058		0.035		0.022
10		0.040		0.058		0.074		0.043		0.028
12		0.048		0.069		0.088		0.052		0.034
14		0.056		0.078		0.096		0.064		0.040
16		0.064		0.088		0.106		0.070		0.046

AU LINE
 EZ LINE -
 ENDMILL
 SE 30
 NITCO 30
 OPTIMUM
 SE 45
 SE 45X
 NITCO 45
 SE 60
 SE 60X
 DN70 -
 SE 70
 SE GR
 TE 45
 PLUNGE
 -MILL
 THREAD
 MILL

Recommended Cutting Data



Note: These recommended cutting data indicators are just for reference. They should be adjusted according to the different cutting condition



SE 45 Short Flutes Long Reach Extra-Long Endmills, 4 Flutes - 899, 901, 909, A22, A23, A32, A33, B33

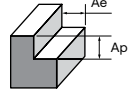

Side Milling	K		P		M		S		H	
Working Material	Ductile Cast Iron		Prehardened steel		Stainless steel		Nickel Alloy		Hardened steel	
Properties	-		35 ≤ HRC < 45		Low Machinability		-		45 ≤ HRC < 52	
Cutting depth, ap	0.25 × D		0.25 × D		0.23 × D		0.18 × D		0.23 × D	
Cutting Width, ae	0.32 × D		0.32 × D		0.32 × D		0.32 × D		0.32 × D	
D	Vc	Fz	Vc	Fz	Vc	Fz	Vc	Fz	Vc	Fz
2	80	0.006	100	0.008	40	0.009	30	0.004	80	0.004
3		0.010		0.013		0.016		0.009		0.006
4		0.014		0.017		0.022		0.014		0.009
5		0.017		0.023		0.028		0.019		0.012
6		0.022		0.031		0.040		0.023		0.014
8		0.029		0.041		0.052		0.032		0.020
10		0.036		0.052		0.067		0.039		0.025
12		0.043		0.062		0.079		0.047		0.031
14		0.050		0.070		0.086		0.058		0.036
16		0.058		0.079		0.095		0.063		0.041
18		0.065		0.089		0.106		0.072		0.047
20		0.072		0.095		0.117		0.079		0.052

SE 45 MultiFlutes Standard Endmills, 6 Flutes - A89, A94, B71, C14

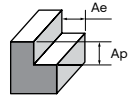

Side Milling	K		P		M		S		H	
Working Material	Ductile Cast Iron		Prehardened steel		Stainless steel		Nickel Alloy		Hardened steel	
Properties	-		35 ≤ HRC < 45		Low Machinability		-		45 ≤ HRC < 52	
Cutting depth, ap	1.00 × D		1.00 × D		1.00 × D		1.00 × D		1.00 × D	
Cutting Width, ae	0.15 × D		0.15 × D		0.10 × D		0.07 × D		0.08 × D	
D	Vc	Fz	Vc	Fz	Vc	Fz	Vc	Fz	Vc	Fz
3	120	0.012	130	0.013	55	0.008	40	0.009	110	0.012
4		0.017		0.018		0.011		0.012		0.017
5		0.022		0.023		0.015		0.016		0.021
6		0.027		0.028		0.019		0.019		0.025
8		0.036		0.038		0.026		0.026		0.034
10		0.045		0.048		0.033		0.035		0.042
12		0.055		0.058		0.041		0.045		0.051
14		0.062		0.067		0.045		0.052		0.059

SE 45 MultiFlutes Standard Endmills, 8 Flutes - A89, A94, B71, C14

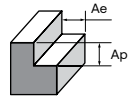

Side Milling	K		P		M		S		H	
Working Material	Ductile Cast Iron		Prehardened steel		Stainless steel		Nickel Alloy		Hardened steel	
Properties	-		35 ≤ HRC < 45		Low Machinability		-		45 ≤ HRC < 52	
Cutting depth, ap	1.00 × D		1.00 × D		1.00 × D		1.00 × D		1.00 × D	
Cutting Width, ae	0.15 × D		0.15 × D		0.10 × D		0.07 × D		0.08 × D	
D	Vc	Fz	Vc	Fz	Vc	Fz	Vc	Fz	Vc	Fz
16	120	0.067	130	0.072	55	0.052	40	0.060	110	0.063
18		0.074		0.078		0.058		0.066		0.071
20		0.081		0.084		0.062		0.069		0.078

ALU LINE
ENDMILL
SE 30
NITCo 30
OPTIMUM
SE 45
SE 45X
NITCo 45
SE 60
SE 60X
DM70 - SE70
SE GR
TE 45
PLUNGE -MILL
THREAD MILL

Note: These recommended cutting data indicators are just for reference. They should be adjusted according to the different cutting condition



SE 45 MultiFlutes Long Endmills, 6 Flutes - A90, A95, B73, C15

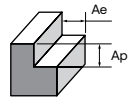

Side Milling	K		P		M		S		H	
Working Material	Ductile Cast Iron		Prehardened steel		Stainless steel		Nickel Alloy		Hardened steel	
Properties	-		35 ≤ HRC < 45		Low Machinability		-		45 ≤ HRC < 52	
Cutting depth, ap	1.50 × D		1.50 × D		1.50 × D		1.50 × D		1.50 × D	
Cutting Width, ae	0.12 × D		0.12 × D		0.08 × D		0.05 × D		0.06 × D	
D	Vc	Fz	Vc	Fz	Vc	Fz	Vc	Fz	Vc	Fz
3	105	0.011	115	0.012	45	0.008	35	0.007	95	0.011
4		0.016		0.016		0.012		0.011		0.016
5		0.020		0.021		0.017		0.016		0.020
6		0.024		0.025		0.021		0.020		0.024
8		0.033		0.034		0.029		0.028		0.033
10		0.042		0.043		0.038		0.036		0.041
12		0.052		0.055		0.048		0.046		0.049
14		0.059		0.062		0.055		0.052		0.057

SE 45 MultiFlutes Long Endmills, 6 Flutes - A90, A95, B73, C15

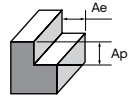

Side Milling	K		P		M		S		H	
Working Material	Ductile Cast Iron		Prehardened steel		Stainless steel		Nickel Alloy		Hardened steel	
Properties	-		35 ≤ HRC < 45		Low Machinability		-		45 ≤ HRC < 52	
Cutting depth, ap	1.50 × D		1.50 × D		1.50 × D		1.50 × D		1.50 × D	
Cutting Width, ae	0.12 × D		0.12 × D		0.08 × D		0.05 × D		0.06 × D	
D	Vc	Fz	Vc	Fz	Vc	Fz	Vc	Fz	Vc	Fz
16	105	0.064	115	0.065	45	0.060	35	0.058	95	0.062
18		0.071		0.072		0.064		0.064		0.069
20		0.077		0.078		0.069		0.068		0.076

SE 45 MultiFlutes Extra-Long Endmills, 6 Flutes - A91, A96, B78, C16

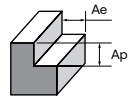

Side Milling	K		P		M		S		H	
Working Material	Ductile Cast Iron		Prehardened steel		Stainless steel		Nickel Alloy		Hardened steel	
Properties	-		35 ≤ HRC < 45		Low Machinability		-		45 ≤ HRC < 52	
Cutting depth, ap	2.00 × D		2.00 × D		2.00 × D		2.00 × D		2.00 × D	
Cutting Width, ae	0.08 × D		0.08 × D		0.05 × D		0.03 × D		0.04 × D	
D	Vc	Fz	Vc	Fz	Vc	Fz	Vc	Fz	Vc	Fz
3	90	0.011	100	0.012	35	0.007	30	0.006	80	0.010
4		0.015		0.016		0.011		0.010		0.014
5		0.020		0.021		0.015		0.014		0.018
6		0.024		0.025		0.019		0.018		0.022
8		0.032		0.034		0.026		0.025		0.030
10		0.041		0.043		0.034		0.032		0.038
12		0.050		0.054		0.043		0.041		0.047
14		0.058		0.062		0.050		0.047		0.054

AU LINE
 EZ LINE -
 ENDMILL
 SE 30
 NITCO 30
 OPTIMUM
 SE 45
 SE 45X
 NITCO 45
 SE 60
 SE 60X
 DN70 -
 SE 70
 SE GR
 TE 45
 PLUNGE
 -MILL
 THREAD
 MILL

Recommended Cutting Data



Note: These recommended cutting data indicators are just for reference. They should be adjusted according to the different cutting condition



SE 45 MultiFlutes Extra-Long Endmills, 6 Flutes - A91, A96, B78, C16

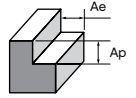

Side Milling	K		P		M		S		H	
Working Material	Ductile Cast Iron		Prehardened steel		Stainless steel		Nickel Alloy		Hardened steel	
Properties	-		35 ≤ HRC < 45		Low Machinability		-		45 ≤ HRC < 52	
Cutting depth, ap	2.00 × D		2.00 × D		2.00 × D		2.00 × D		2.00 × D	
Cutting Width, ae	0.08 × D		0.08 × D		0.05 × D		0.03 × D		0.04 × D	
D	Vc	Fz	Vc	Fz	Vc	Fz	Vc	Fz	Vc	Fz
16	90	0.062	100	0.064	35	0.054	30	0.052	80	0.060
18		0.069		0.071		0.058		0.058		0.066
20		0.076		0.079		0.062		0.061		0.072

SE 45 Miniature Long Neck Endmills, 2 Flutes - 885, A03, A79, B66

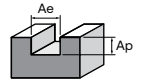

Slotting	K			P			M			S			H			
Working Material	Ductile Cast Iron			Prehardened steel			Stainless steel			Nickel Alloy			Hardened steel			
Properties	-			35 ≤ HRC < 45			Low Machinability			-			45 ≤ HRC < 52			
D	Effective Length	Ap	N	Fz	Ap	N	Fz	Ap	N	Fz	Ap	N	Fz	Ap	N	Fz
0.2	0.5	0.013	34380	0.004		38200	0.004	0.008	27000	0.002	0.006	16880	0.002	0.010	33750	0.002
	1.0	0.009	34430	0.003	0.010	38250	0.003	0.006	27000	0.002	0.004	16880	0.002	0.007	33750	0.002
	1.5	0.005	30990	0.003	0.006	34430	0.003	0.003	24300	0.002	0.002	15190	0.002	0.004	30380	0.002
0.3	1.0	0.014	30600	0.005	0.015	34000	0.005	0.008	24000	0.004	0.006	15000	0.004	0.011	30000	0.004
	2.0	0.007	27540	0.005	0.008	30600	0.005	0.005	21600	0.003	0.004	13500	0.003	0.006	27000	0.003
	3.0	0.005	27540	0.005	0.006	30600	0.005	0.003	21600	0.003	0.002	13500	0.003	0.004	27000	0.003
0.4	2.0	0.018	24480	0.007	0.020	27200	0.007	0.011	19200	0.007	0.008	12000	0.005	0.014	24000	0.006
	3.0	0.010	22030	0.006	0.011	24480	0.006	0.006	17280	0.006	0.005	10800	0.005	0.008	21600	0.005
	4.0	0.006	22030	0.006	0.007	24480	0.006	0.004	17280	0.006	0.003	10800	0.005	0.005	21600	0.005
0.5	5.0	0.006	19580	0.005	0.007	21760	0.005	0.004	15360	0.005	0.003	9600	0.004	0.005	19200	0.004
	2.0	0.023	24480	0.008	0.025	27200	0.008	0.014	19200	0.008	0.011	12000	0.006	0.018	24000	0.007
	4.0	0.013	22030	0.007	0.014	24480	0.007	0.008	17280	0.007	0.006	10800	0.005	0.010	21600	0.006
0.6	6.0	0.008	19580	0.006	0.009	21760	0.006	0.005	15360	0.006	0.004	9600	0.005	0.007	19200	0.006
	8.0	0.005	19580	0.005	0.006	21760	0.005	0.003	15360	0.005	0.002	9600	0.005	0.004	19200	0.005
	2.0	0.027	24480	0.009	0.029	27200	0.009	0.017	19200	0.009	0.013	12000	0.007	0.021	24000	0.008
0.7	4.0	0.016	22030	0.008	0.017	24480	0.008	0.010	17280	0.008	0.007	10800	0.006	0.012	21600	0.007
	6.0	0.010	22030	0.007	0.011	24480	0.007	0.006	17280	0.007	0.005	10800	0.005	0.008	21600	0.006
	10.0	0.005	19580	0.006	0.006	21760	0.006	0.004	15360	0.006	0.003	9600	0.005	0.005	19200	0.005
0.8	2.0	0.046	24480	0.010	0.049	27200	0.010	0.028	19200	0.010	0.021	12000	0.008	0.035	24000	0.009
	4.0	0.032	22030	0.009	0.034	24480	0.009	0.020	17280	0.009	0.015	10800	0.007	0.025	21600	0.008
	6.0	0.012	22030	0.008	0.013	24480	0.008	0.007	17280	0.009	0.005	10800	0.007	0.009	21600	0.008
0.9	8.0	0.012	19580	0.008	0.013	21760	0.008	0.007	15360	0.008	0.005	9600	0.006	0.009	19200	0.007
	10.0	0.012	19580	0.008	0.013	21760	0.008	0.007	15360	0.008	0.005	9600	0.006	0.009	19200	0.007
	4.0	0.036	24480	0.012	0.039	27200	0.011	0.022	18560	0.012	0.017	11600	0.009	0.028	23200	0.010
1.0	6.0	0.021	22030	0.012	0.022	24480	0.011	0.013	16640	0.012	0.010	10400	0.009	0.016	20800	0.010
	8.0	0.013	22030	0.011	0.014	24480	0.010	0.008	16480	0.010	0.006	10300	0.008	0.010	20600	0.009
	10.0	0.013	19580	0.009	0.014	21760	0.009	0.008	15360	0.008	0.006	9600	0.007	0.010	19200	0.008
1.0	12.0	0.007	19580	0.008	0.008	21760	0.009	0.005	15360	0.008	0.004	9600	0.007	0.006	19200	0.008
	6.0	0.023	22030	0.014	0.025	24480	0.013	0.014	17280	0.013	0.011	10800	0.012	0.018	21600	0.013
	8.0	0.015	22030	0.013	0.016	24480	0.012	0.009	17280	0.012	0.007	10800	0.011	0.012	21600	0.012
1.0	10.0	0.015	19580	0.008	0.016	21760	0.008	0.009	15360	0.008	0.007	9600	0.007	0.012	19200	0.008
	15.0	0.015	19580	0.008	0.016	21760	0.008	0.009	15360	0.008	0.007	9600	0.007	0.012	19200	0.008
	6.0	0.028	23400	0.014	0.032	26000	0.013	0.016	18400	0.015	0.012	11500	0.012	0.020	23000	0.013
1.0	8.0	0.024	22500	0.013	0.028	25000	0.013	0.016	17520	0.014	0.012	10950	0.011	0.020	21900	0.012
	10.0	0.020	21600	0.012	0.024	24000	0.012	0.010	16720	0.013	0.008	10450	0.011	0.013	20900	0.012
	12.0	0.018	20700	0.012	0.020	23000	0.012	0.010	15920	0.012	0.008	9950	0.010	0.013	19900	0.011
1.0	14.0	0.015	19800	0.012	0.016	22000	0.011	0.010	15120	0.012	0.008	9450	0.009	0.013	18900	0.010
	16.0	0.010	18900	0.011	0.011	21000	0.011	0.006	14320	0.011	0.005	8950	0.009	0.008	17900	0.010

cont'd ▶

ALU LINE
EZ LINE - ENDMILL
SE 30
NITCo 30
OPTIMUM
SE 45
SE 45X
NITCo 45
SE 60
SE 60X
DM70 - SE70
SE GR
TE 45
PLUNGE -MILL
THREAD MILL

Recommended Cutting Data



Note: These recommended cutting data indicators are just for reference. They should be adjusted according to the different cutting condition



SE 45 Miniature Long Neck Endmills, 2 Flutes - 885, A03, A79, B66

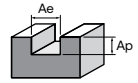

Slotting		K			P			M			S			H			
Working Material		Ductile Cast Iron			Prehardened steel			Stainless steel			Nickel Alloy			Hardened steel			
Properties		-			35 ≤ HRC < 45			Low Machinability			-			45 ≤ HRC < 52			
D	Effective Length	Ap	N	Fz	Ap	N	Fz	Ap	N	Fz	Ap	N	Fz	Ap	N	Fz	
1.2	6.0	0.055	20250	0.015	0.059	22500	0.015	0.034	15680	0.018	0.025	9800	0.014	0.042	19600	0.015	
	8.0	0.048	19800	0.015	0.052	22000	0.014	0.022	15520	0.017	0.014	9700	0.013	0.030	19400	0.014	
	10.0	0.041	19350	0.014	0.045	21500	0.014	0.012	15360	0.015	0.009	9600	0.012	0.020	19200	0.013	
	12.0	0.026	18900	0.014	0.030	21000	0.013	0.012	15200	0.014	0.009	9500	0.011	0.015	19000	0.012	
1.4	6.0	0.065	17820	0.018	0.070	19800	0.018	0.040	14000	0.021	0.030	8750	0.015	0.050	17500	0.017	
	8.0	0.050	17640	0.017	0.060	19600	0.017	0.030	13840	0.020	0.020	8650	0.014	0.040	17300	0.016	
	10.0	0.045	17460	0.016	0.050	19400	0.016	0.020	13680	0.018	0.015	8550	0.014	0.030	17100	0.015	
	12.0	0.035	17280	0.015	0.040	19200	0.015	0.016	13520	0.017	0.012	8450	0.013	0.018	16900	0.014	
1.4	14.0	0.025	17100	0.014	0.030	19000	0.014	0.014	13360	0.016	0.010	8350	0.012	0.015	16700	0.013	
	16.0	0.015	16920	0.013	0.020	18800	0.013	0.011	13200	0.015	0.009	8250	0.011	0.012	16500	0.012	
	1.5	6.0	0.070	17190	0.020	0.077	19100	0.019	0.044	13440	0.018	0.033	8400	0.016	0.055	16800	0.018
		8.0	0.060	16740	0.019	0.070	18600	0.018	0.032	13280	0.018	0.024	8300	0.016	0.040	16600	0.018
10.0		0.055	16380	0.018	0.062	18200	0.017	0.024	12960	0.018	0.018	8100	0.016	0.030	16200	0.018	
12.0		0.045	16020	0.017	0.053	17800	0.017	0.024	12640	0.015	0.018	7900	0.014	0.030	15800	0.015	
1.5	14.0	0.035	15750	0.016	0.044	17500	0.017	0.015	12240	0.015	0.011	7650	0.014	0.019	15300	0.015	
	16.0	0.030	15300	0.015	0.035	17000	0.016	0.015	11920	0.012	0.011	7450	0.011	0.019	14900	0.012	
	18.0	0.028	14850	0.014	0.030	16500	0.015	0.015	11600	0.012	0.011	7250	0.011	0.019	14500	0.012	
	20.0	0.025	14400	0.013	0.027	16000	0.013	0.015	11040	0.012	0.011	6900	0.011	0.019	13800	0.012	
1.6	6.0	0.084	16650	0.021	0.091	18500	0.020	0.055	13120	0.020	0.040	8200	0.017	0.065	16400	0.019	
	8.0	0.077	16200	0.020	0.084	18000	0.019	0.045	13040	0.019	0.030	8150	0.016	0.055	16300	0.018	
	10.0	0.069	16020	0.019	0.076	17800	0.018	0.030	12880	0.018	0.023	8050	0.015	0.040	16100	0.017	
	12.0	0.062	15840	0.018	0.069	17600	0.018	0.025	12720	0.017	0.020	7950	0.014	0.035	15900	0.016	
1.6	14.0	0.053	15660	0.017	0.060	17400	0.017	0.020	12560	0.016	0.018	7850	0.014	0.030	15700	0.015	
	16.0	0.044	15480	0.016	0.051	17200	0.016	0.016	12400	0.015	0.013	7750	0.013	0.026	15500	0.014	
	18.0	0.039	15300	0.015	0.046	17000	0.015	0.016	12240	0.014	0.013	7650	0.012	0.023	15300	0.013	
	20.0	0.036	15120	0.014	0.043	16800	0.014	0.016	12080	0.013	0.012	7550	0.011	0.020	15100	0.012	
1.8	6.0	0.105	15480	0.023	0.120	17200	0.021	0.065	12240	0.022	0.050	7650	0.018	0.075	15300	0.020	
	8.0	0.095	15300	0.022	0.115	17000	0.020	0.055	12080	0.021	0.040	7550	0.018	0.065	15100	0.020	
	10.0	0.085	15120	0.021	0.105	16800	0.019	0.035	11920	0.020	0.030	7450	0.017	0.045	14900	0.019	
	12.0	0.080	14940	0.020	0.110	16600	0.019	0.030	11760	0.019	0.025	7350	0.016	0.035	14700	0.018	
1.8	14.0	0.080	14760	0.019	0.100	16400	0.018	0.020	11600	0.018	0.019	7250	0.015	0.021	14500	0.017	
	16.0	0.070	14580	0.018	0.090	16200	0.017	0.020	11440	0.017	0.016	7150	0.014	0.021	14300	0.016	
	18.0	0.060	14400	0.017	0.080	16000	0.016	0.018	11280	0.016	0.016	7050	0.014	0.021	14100	0.015	
	20.0	0.050	14220	0.016	0.070	15800	0.015	0.018	11120	0.015	0.014	6950	0.013	0.020	13900	0.014	
2.0	6.0	0.130	14400	0.025	0.145	16000	0.023	0.080	11520	0.024	0.060	7200	0.019	0.100	14400	0.021	
	8.0	0.120	14220	0.024	0.140	15800	0.022	0.056	11360	0.023	0.042	7100	0.019	0.070	14200	0.021	
	10.0	0.110	14040	0.023	0.130	15600	0.021	0.056	11200	0.022	0.042	7000	0.019	0.070	14000	0.021	
	12.0	0.100	13680	0.022	0.120	15200	0.021	0.040	10880	0.021	0.030	6800	0.019	0.050	13600	0.021	
2.0	14.0	0.090	13500	0.022	0.110	15000	0.020	0.032	10720	0.021	0.024	6700	0.019	0.040	13400	0.021	
	16.0	0.080	13140	0.021	0.100	14600	0.020	0.032	10480	0.019	0.024	6550	0.017	0.040	13100	0.019	
	18.0	0.070	12870	0.020	0.090	14300	0.019	0.020	10240	0.019	0.015	6400	0.017	0.025	12800	0.019	
	20.0	0.060	12600	0.019	0.080	14000	0.019	0.020	9920	0.019	0.015	6200	0.017	0.025	12400	0.019	
2.0	25.0	0.050	12330	0.018	0.070	13700	0.018	0.020	9680	0.017	0.015	6050	0.015	0.025	12100	0.017	
	30.0	0.040	12150	0.017	0.060	13500	0.018	0.012	9520	0.017	0.009	5950	0.015	0.015	11900	0.017	
	2.5	8.0	0.130	11520	0.031	0.145	12800	0.028	0.100	9280	0.030	0.080	5800	0.023	0.120	11600	0.026
		10.0	0.120	11390	0.03	0.135	12650	0.027	0.080	9120	0.030	0.060	5700	0.023	0.095	11400	0.026
12.0		0.105	11250	0.029	0.125	12500	0.027	0.060	8960	0.029	0.050	5600	0.023	0.080	11200	0.025	
14.0		0.095	11120	0.028	0.115	12350	0.026	0.045	8800	0.028	0.035	5500	0.023	0.065	11000	0.024	
2.5	16.0	0.085	10980	0.027	0.105	12200	0.026	0.040	8660	0.027	0.030	5350	0.021	0.058	10700	0.023	
	18.0	0.075	10890	0.026	0.095	12100	0.025	0.035	8480	0.026	0.025	5300	0.020	0.047	10600	0.022	
	20.0	0.067	10800	0.025	0.085	12000	0.025	0.035	8400	0.026	0.025	5250	0.020	0.047	10500	0.022	
	25.0	0.055	10350	0.024	0.070	11500	0.024	0.030	8160	0.025	0.020	5100	0.019	0.033	10200	0.021	
30.0	0.040	9900	0.023	0.065	11000	0.023	0.015	7840	0.024	0.012	4900	0.019	0.030	9800	0.020		

cont'd ▶

ALU LINE
EZ LINE -
ENDMILL
SE 30
NITICO 30
OPTIMUM
SE 45
SE 45X
NITICO 45
SE 60
SE 60X
DN70 -
SE 70
SE GR
TE 45
PLUNGE
-MILL
THREAD
MILL

Note: These recommended cutting data indicators are just for reference. They should be adjusted according to the different cutting condition



SE 45 Miniature Long Neck Endmills, 2 Flutes - 885, A03, A79, B66

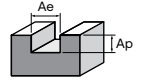

Slotting		K			P			M			S			H		
Working Material		Ductile Cast Iron			Prehardened steel			Stainless steel			Nickel Alloy			Hardened steel		
Properties		-			35 ≤ HRC < 45			Low Machinability			-			45 ≤ HRC < 52		
D	Effective Length	Ap	N	Fz	Ap	N	Fz	Ap	N	Fz	Ap	N	Fz	Ap	N	Fz
3.0	8.0	0.140	9790	0.036	0.150	10880	0.034	0.120	7920	0.036	0.090	4950	0.028	0.140	9900	0.031
	10.0	0.130	9760	0.036	0.140	10840	0.033	0.100	7800	0.035	0.080	4880	0.028	0.120	9750	0.031
	12.0	0.110	9720	0.035	0.130	10800	0.032	0.085	7680	0.034	0.070	4800	0.026	0.105	9600	0.029
	14.0	0.100	9680	0.034	0.120	10750	0.032	0.070	7520	0.033	0.060	4700	0.025	0.090	9400	0.028
	16.0	0.090	9630	0.033	0.110	10700	0.032	0.055	7360	0.032	0.050	4600	0.024	0.075	9200	0.027
	18.0	0.080	9540	0.032	0.100	10600	0.031	0.043	7240	0.031	0.040	4530	0.023	0.068	9050	0.026
	20.0	0.075	9450	0.032	0.090	10500	0.029	0.038	7120	0.030	0.036	4450	0.023	0.060	8900	0.026
4.0	25.0	0.062	9270	0.031	0.070	10300	0.029	0.032	7000	0.029	0.028	4380	0.023	0.040	8750	0.025
	10.0	0.150	7520	0.047	0.160	8350	0.045	0.140	6000	0.042	0.120	3750	0.039	0.150	7500	0.043
	15.0	0.110	7380	0.046	0.120	8200	0.042	0.100	5840	0.040	0.084	3650	0.037	0.110	7300	0.041
	20.0	0.090	7200	0.045	0.100	8000	0.041	0.080	5720	0.038	0.070	3580	0.036	0.090	7150	0.040
	25.0	0.075	6930	0.043	0.080	7700	0.039	0.060	5600	0.036	0.050	3500	0.034	0.070	7000	0.038
	30.0	0.065	6660	0.038	0.070	7400	0.035	0.050	5440	0.030	0.040	3400	0.029	0.060	6800	0.032
	40.0	0.055	5820	0.033	0.060	6470	0.031	0.040	4800	0.026	0.030	3000	0.025	0.050	6000	0.028

SE 45 Miniature Endmills, 2 Flutes - 883, A01

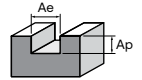

Slotting		K			P			M			S			H		
Working Material		Ductile Cast Iron			Prehardened steel			Stainless steel			Nickel Alloy			Hardened steel		
Properties		-			35 ≤ HRC < 45			Low Machinability			-			45 ≤ HRC < 52		
D		Ap	N	Fz	Ap	N	Fz	Ap	N	Fz	Ap	N	Fz	Ap	N	Fz
0.1		0.010	50000	0.003	0.011		0.003	0.004	50000	0.002	0.003	44000	0.001	0.005	50000	0.002
0.2		0.013	36000	0.005	0.014	39000	0.005	0.008	30000	0.004	0.006	21000	0.003	0.010	37500	0.004
0.3		0.014	32000	0.006	0.015	35000	0.006	0.008	27000	0.005	0.006	18000	0.004	0.011	33400	0.005
0.4		0.018	25500	0.008	0.020	28000	0.008	0.011	22000	0.007	0.008	15500	0.005	0.014	28000	0.006
0.5		0.023	25000	0.010	0.025	27800	0.010	0.014	20000	0.008	0.011	14000	0.006	0.018	26000	0.007
0.6		0.027	24700	0.012	0.029	27400	0.012	0.017	19500	0.010	0.013	13500	0.008	0.021	25000	0.01
0.7		0.032	24650	0.012	0.038	27200	0.012	0.021	19400	0.011	0.015	12800	0.009	0.025	24400	0.011
0.8		0.036	24500	0.014	0.040	27000	0.015	0.026	19000	0.015	0.017	12600	0.010	0.030	24000	0.012
0.9		0.040	22500	0.016	0.045	25400	0.017	0.029	18000	0.016	0.019	12400	0.011	0.034	22800	0.013
1.0		0.048	22000	0.019	0.050	24000	0.020	0.030	17000	0.018	0.022	12000	0.014	0.038	22000	0.015
1.2		0.055	21000	0.020	0.060	23000	0.021	0.034	16000	0.018	0.025	11200	0.015	0.042	19200	0.018
1.4		0.065	20300	0.021	0.070	21200	0.023	0.040	15000	0.019	0.030	10200	0.017	0.050	17600	0.020
1.5		0.072	19500	0.022	0.077	20800	0.024	0.044	14000	0.021	0.033	10000	0.018	0.055	17000	0.021
1.6		0.078	19000	0.023	0.083	19800	0.025	0.048	13000	0.023	0.036	9800	0.019	0.060	16500	0.022
1.8		0.085	18000	0.025	0.091	19000	0.027	0.052	12500	0.024	0.039	9200	0.021	0.065	15500	0.024
2.0		0.102	17000	0.027	0.120	18000	0.029	0.080	11500	0.027	0.045	8900	0.023	0.072	14500	0.026

ALU LINE
ENDMILL
SE 30
NITCo 30
OPTIMUM
SE 45
SE 45X
NITCo 45
SE 60
SE 60X
DM70 - SE70
SE GR
TE 45
PLUNGE-MILL
THREAD MILL

Recommended Cutting Data



Note: These recommended cutting data indicators are just for reference. They should be adjusted according to the different cutting condition



SE 45R Torus Taper Neck Endmills, 2 Flutes - A25

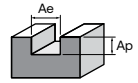

Slotting		K			P			M			S			H		
Working Material		Ductile Cast Iron			Prehardened steel			Stainless steel			Nickel Alloy			Hardened steel		
Properties		-			35 ≤ HRC < 45			Low Machinability			-			45 ≤ HRC < 52		
D	Effective Length	Ap	N	Fz	Ap	N	Fz	Ap	N	Fz	Ap	N	Fz	Ap	N	Fz
1.0	20	0.023	18900	0.011	0.025	21000	0.011	0.006	13430	0.011	0.005	8950	0.009	0.008	17900	0.010
	40	0.011	15300	0.011	0.012	17000	0.011	0.004	10130	0.011	0.003	6750	0.009	0.005	13500	0.010
1.5	20	0.036	14400	0.013	0.040	16000	0.013	0.015	10350	0.013	0.011	6900	0.011	0.019	13800	0.012
	40	0.032	12690	0.012	0.035	14100	0.012	0.010	8630	0.013	0.007	5750	0.011	0.012	11500	0.012
2.0	20	0.072	12600	0.019	0.080	14000	0.019	0.020	9300	0.021	0.015	6200	0.017	0.025	12400	0.019
	40	0.054	12150	0.018	0.060	13500	0.018	0.012	8930	0.019	0.009	5950	0.015	0.015	11900	0.017
3.0	20	0.081	9450	0.029	0.090	10500	0.029	0.048	6680	0.029	0.036	4450	0.023	0.060	8900	0.026
	40	0.059	8370	0.028	0.065	9300	0.028	0.024	5780	0.029	0.018	3850	0.023	0.030	7700	0.026
4.0	45	0.054	8280	0.027	0.060	9200	0.027	0.020	5700	0.028	0.015	3800	0.023	0.025	7600	0.025
	20	0.090	7200	0.041	0.100	8000	0.041	0.072	5360	0.044	0.054	3580	0.036	0.090	7150	0.040
6.0	40	0.063	5823	0.041	0.070	6470	0.041	0.040	4500	0.039	0.030	3000	0.032	0.050	6000	0.035
	60	0.054	5400	0.038	0.060	6000	0.038	0.032	4280	0.035	0.024	2850	0.029	0.040	5700	0.032
8.0	20	0.108	4950	0.065	0.120	5500	0.065	0.080	3640	0.068	0.060	2430	0.056	0.100	4850	0.062
	40	0.081	4050	0.062	0.090	4500	0.062	0.064	3150	0.064	0.048	2100	0.052	0.080	4200	0.058
10.0	60	0.072	3780	0.061	0.080	4200	0.061	0.056	2930	0.058	0.042	1950	0.048	0.070	3900	0.053
	80	0.054	3420	0.060	0.060	3800	0.060	0.040	2630	0.053	0.030	1750	0.043	0.050	3500	0.048
12.0	25	0.126	3780	0.090	0.140	4200	0.090	0.088	2740	0.094	0.066	1830	0.077	0.110	3650	0.085
	60	0.090	2970	0.085	0.100	3300	0.085	0.064	2250	0.083	0.048	1500	0.068	0.080	3000	0.075
15.0	75	0.063	2700	0.080	0.070	3000	0.080	0.048	2030	0.072	0.036	1350	0.059	0.060	2700	0.065
	105	0.050	2520	0.070	0.055	2800	0.070	0.036	1880	0.057	0.027	1250	0.047	0.045	2500	0.052
20.0	30	0.135	3060	0.115	0.150	3400	0.115	0.096	2210	0.127	0.072	1480	0.104	0.120	2950	0.115
	70	0.072	2520	0.100	0.080	2800	0.100	0.056	1730	0.110	0.042	1150	0.090	0.070	2300	0.100
25.0	75	0.068	2385	0.095	0.075	2650	0.095	0.048	1650	0.105	0.036	1100	0.086	0.060	2200	0.095
	35	0.144	2610	0.142	0.160	2900	0.142	0.104	1880	0.154	0.078	1250	0.126	0.130	2500	0.140
30.0	70	0.081	2160	0.125	0.090	2400	0.125	0.048	1500	0.132	0.036	1000	0.108	0.060	2000	0.120
	100	0.063	1980	0.110	0.070	2200	0.110	0.032	1430	0.110	0.024	950	0.090	0.040	1900	0.100

AU LINE
 EZ LINE -
 ENDMILL
 SE 30
 NITICO 30
 OPTIMUM
 SE 45
 SE 45X
 NITICO 45
 SE 60
 SE 60X
 DN70 -
 SE 70
 SE GR
 TE 45
 PLUNGE
 -MILL
 THREAD
 MILL

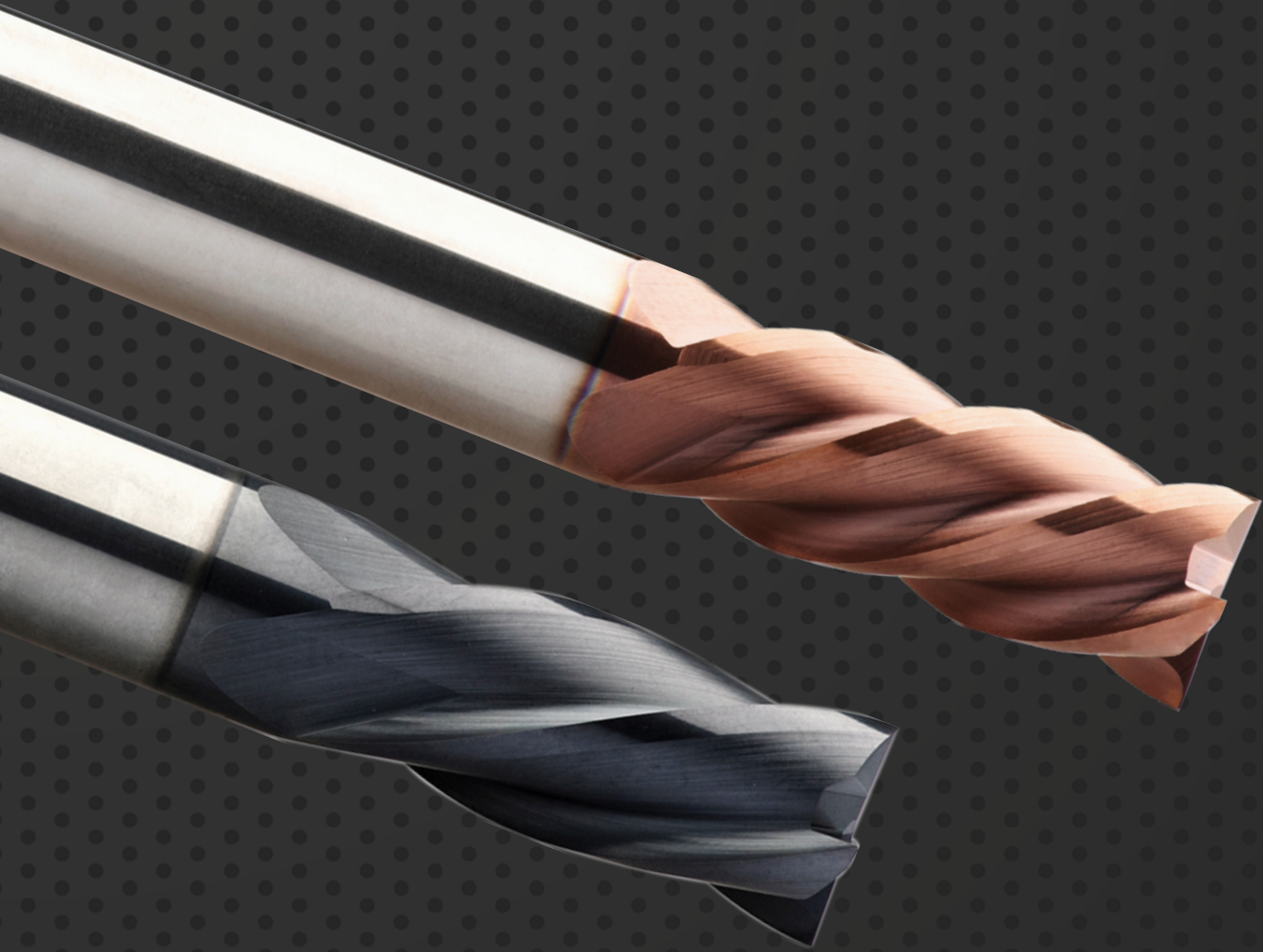

ENDMILLS





SE 45X

For material application ≤ 52 HRC

Index - SE 45X, For ≤ 52 HRC

 Suitable for Material Groups
  Adapté pour les matériaux
  适用于材料
 Geeignet für die Materialgruppen
  Adatto per il materiale

P **H**

	EDP Number	Type	No. Z	Helix Angle	Coating	Performance	Page Number
NEW	887 	SE 45X DP	4	40°	B0819	P	235
	543 	SE 45X DP	4	40°	G6110	P	236
NEW	635 	SE 45X DP, Recess	4	40°	B0819	P	235
NEW	A06 	SE 45X DP	4	40°	B0909	P	235
NEW	A07 	SE 45X DP, Recess	4	40°	B0909	P	235

G - General P - Performance

FEATURES & BENEFITS

SE 45X



Top View

1 Gash Land Design



Improves strength and provide great chipping resistance.

2 Differential Pitch (DP) Design



Provides excellent surface finishing while eliminating chatter

3 Ideal Cutting Edge

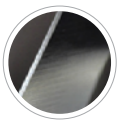

Provide edge protection to prolong tool life



4 Cutting Edge Preparation

- Enhances tool life
- Less material adhere on the cutting edge for stable machining
- Improves wear resistance and reduces excessive friction

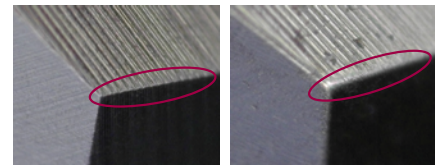

5 Superior Coating to Reduce Friction

- Increases hardness and higher abrasive wear resistance
- Higher thermal resistance
- Smoother chips evacuation

6 Harder material

- Improves rigidity
- Improves surface finishing and maximizes tool life

7 Suitable for Materials

- For excellent finishing process in Mould & Die
- HRC 40 ~55 (Ae ≤ 0.5mm)





1. Stirnschliff Design
Verbessert die Leistung deutlich und bietet Schutz gegen Ausbrüche
2. Ungleiche Teilung (DP)
Per una lavorazione senza vibrazione e finiture superficiali eccellenti
3. Perfekte Schneide
Bietet Schneidkantenschutz, um die Lebensdauer des Werkzeugs zu verlängern
4. Schneidkantenbehandlung
Verbessert die Werkzeuglebensdauer
Weniger Materialanhaftungen an der Schneide Für stabile Bearbeitung
Verbessert die Verschleißfestigkeit und reduziert übermäßige Reibung
5. Ausgezeichnete Beschichtung zur Verringerung der Reibung
Erhöht die Härte und und bietet bessere Verschleißfestigkeit
Höhere Temperaturbeständigkeit
Glatte Oberfläche für besseren Spänefluß
6. Härteres Material
Verbessert die Steifigkeit
Verbessert die Oberflächenbearbeitung und maximiert die Standzeit
7. Geeignet für Materialgruppen P,H
Für exzellenten Veredelungsprozess in Mold & Die
HRC 40 ~55 (Ae ≤ 0.5mm)



1. 底刃斜面式设计
显著提高强度, 提供极好的耐崩裂性。
2. 不等分割設計 (DP)
有效降低加工時的振動從而, 達到更好的工件表面光潔度。
3. 理想的切削刃
提供边缘保护延长刀具寿命。
4. 切削刃设置提高刀具寿命
提高刀具寿命。
切削刃上的材料附着少, 加工稳定。
提高耐磨性并减少过度摩擦。
5. 优异的涂层, 减少摩擦
增加硬度, 提高材料耐磨性。
更高的抗热性。
更顺畅的排屑。
6. 较硬的材料
提高刚性。
改善表面光洁度并最大限度地延长刀具寿命。
7. 适用于材料 P、H
在模具和模具中获得出色的精加工工艺
HRC 40 ~55 (Ae ≤ 0.5mm)



1. Struttura area sgrossatura
Migliora notevolmente la potenza e offre un'eccellente resistenza alle scheggiature
grande resistenza alla scheggiatura.
2. Design del passo differenziale (DP)
Design del passo differenziale (DP) Riduce le vibrazioni, massimizza la produttività e la durata dell'utensile.
3. Angolo di taglio ideale
Offre una protezione degli angoli per prolungare la durata dello strumento
4. Preparazione dell'angolo di taglio
Migliora la durata dello strumento
Meno materiale che aderisce sull'angolo di taglio per una lavorazione stabile
Migliora la resistenza all'usura e riduce l'attrito eccessivo
5. Rivestimento superiore per ridurre la frizione
Aumenta la durezza e una maggiore resistenza all'usura abrasiva
Resistenza termica superiore
Evacuazione dei trucioli più semplice
6. Materiale più duro
Migliora la rigidità
Migliora la finitura superficiale e massimizza la durata dell'utensile
7. Adatto per materiali
Per un eccellente processo di finitura in Mould & Die
HRC 40 ~55 (Ae ≤ 0.5mm)



1. Conception de fraise pour l'usinage general
Améliore considérablement la solidité et apporte une excellente résistance à l'ébarbage
grande résistance à l'écaillage.
2. Conception à pas différentiel (DP)
Pour un usinage sans vibrations et un très bon état de surface
3. Arête tranchante idéale
Protège les arêtes pour prolonger la durée de vie de l'outil
4. Préparation des arêtes de coupes
Améliore la durée de vie de l'outil
Moins de matériau adhère à l'arête tranchante pour un usinage stable
Améliore la résistance à l'usure et réduit les frottements excessifs
5. Revêtement supérieur pour réduire la friction
Augmente la dureté et la résistance à l'abrasion
Résistance thermique supérieure
Évacuation des copeaux plus fluide
6. Matériau plus dur
Améliore la rigidité
Améliore la finition de surface et maximise la durée de vie de l'outil
7. Convient aux matériaux
Pour un excellent processus de finition dans Mold & Die
HRC 40 ~55 (Ae ≤ 0.5mm)

SE 45X DP ENDMILLS, 4 FLUTES

- VHM SE 45X DP Fräser, 4 Zähne
- Frese SE 45X DP in metallo duro integrale, 4 taglianti
- Fraises 2 tailles SE 45X DP - 4 dents
- 整体硬质合金 SE 45X DP 系列 4刃平底铣刀

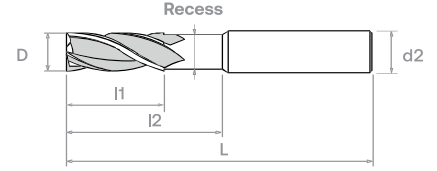
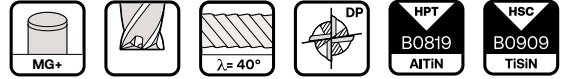

Order Number	Dimension (mm)					B0819	Order Number	Dimension (mm)					B0819
	D	I1	I2	L	d2 (h6)			D	I1	I2	L	d2 (h6)	
887 0100 050 04	1	3		50	4	o	635 0100 050 04	1	3		50	4	
887 0150 050 04	1.5	4.5		50	4	o	635 0150 050 04	1.5	4.5		50	4	
887 0200 050 04	2	6.5		50	4	o	635 0200 050 04	2	6.5		50	4	
887 0250 050 04	2.5			50	4	o	635 0250 050 04	2.5				50	4
887 0300	3	9		40	3	•	635 0300	3	9	15	40	3	o
887 0300 050 06				50	6	o	635 0300 050 06				15	50	6
887 0350 050 04	3.5	12		50	4	•	635 0350 050 04 *	3.5	12	20	50	4	o
887 0400	4			50	4	•	635 0400 *	4			20	50	4
887 0400 050 06	4.5	15		50	6	•	635 0400 050 06	4.5	15	20	50	6	o
887 0450 050 05				50	5	•	635 0450 050 05 *				20	50	5
887 0500	5	16		50	5	•	635 0500 *	5	16	20	50	5	o
887 0500 050 06	5.5			50	6	o	635 0500 050 06	5.5			20	50	6
887 0550 050 06				50	6	o	635 0550 050 06				20	50	6
887 0600 050	6	20		50	6	•	635 0600 050	6	20	20	50	6	o
887 0600 060					60	6	•			635 0600 060			30
887 0700 064 08	7	22		64	8	o	635 0700 064 08	7	22	30	64	8	o
887 0800	8			64	8	•	635 0800	8			30	64	8
887 0900 070 10	9	25		70	10	o	635 0900 070 10	9	25	32	70	10	o
887 1000 070	10			70	10	o	635 1000 070	10			32	70	10
887 1100 075 12	11	32		75	12	o	635 1100 075 12	11	32	37	75	12	o
887 1200	12			75	12	o	635 1200	12			37	75	12
887 1400	14	38		90	14	•	635 1400 *	14	38	44	90	14	o
887 1600	16			90	16	•	635 1600	16			46	90	16
887 2000	20		100	20	•	635 2000	20		58	100	20	o	

Order Number	Dimension (mm)					B0909	Order Number	Dimension (mm)					B0909
	D	I1	I2	L	d2 (h6)			D	I1	I2	L	d2 (h6)	
A06 0100 050 04	1	3		50	4	o	A07 0100 050 04	1	3		50	4	
A06 0150 050 04	1.5	4.5		50	4	•	A07 0150 050 04	1.5	4.5		50	4	
A06 0200 050 04	2	6.5		50	4	•	A07 0200 050 04	2	6.5		50	4	
A06 0250 050 04	2.5			50	4	•	A07 0250 050 04	2.5				50	4
A06 0300	3	9		40	3	•	A07 0300	3	9	15	40	3	o
A06 0300 050 06				50	6	•	A07 0300 050 06				15	50	6
A06 0350 050 04 *	3.5	12		50	4	o	A07 0350 050 04	3.5	12	20	50	4	o
A06 0400 *	4			50	4	•	A07 0400	4			20	50	4
A06 0400 050 06	4.5	15		50	6	•	A07 0400 050 06	4.5	15	20	50	6	•
A06 0450 050 05 *				50	5	o	A07 0450 050 05				20	50	5
A06 0500 *	5	16		50	5	•	A07 0500	5	16	20	50	5	o
A06 0500 050 06	5.5			50	6	•	A07 0500 050 06	5.5			20	50	6
A06 0550 050 06				50	6	•	A07 0550 050 06				20	50	6
A06 0600 050	6	20		50	6	•	A07 0600 050	6	20	20	50	6	o
A06 0600 060					60	6	•			A07 0600 060			30
A06 0700 064 08	7	22		64	8	•	A07 0700 064 08	7	22	30	64	8	o
A06 0800	8			64	8	•	A07 0800	8			30	64	8
A06 0900 070 10	9	25		70	10	o	A07 0900 070 10	9	25	32	70	10	o
A06 1000 070	10			70	10	•	A07 1000 070	10			32	70	10
A06 1100 075 12	11	32		75	12	•	A07 1100 075 12	11	32	37	75	12	o
A06 1200	12			75	12	•	A07 1200	12			37	75	12
A06 1400 *	14	38		90	14	•	A07 1400	14	38	44	90	14	o
A06 1600	16			90	16	•	A07 1600	16			46	90	16
A06 2000	20		100	20	•	A07 2000	20		58	100	20	o	

* - DIN 6535

Material Group | Material-Gruppe | Groupe Matière | Gruppo Materiali | 材质主类

Cutting Parameter

N01	N02	N03	K01	K02	P01	P02	P03	M01	M02	S01	S02	S03	H01	H02	O01	O02	237
-----	-----	-----	-----	-----	-----	-----	-----	-----	-----	-----	-----	-----	-----	-----	-----	-----	-----

SE 45X DP ENDMILLS, 4 FLUTES

- VHM SE 45X DP Fräser, 4 Zähne
- Frese SE 45X DP in metallo duro integrale, 4 taglienti
- Fraises 2 tailles SE 45X DP - 4 dents
- 整体硬质合金 SE 45X DP 系列 4刃平底铣刀

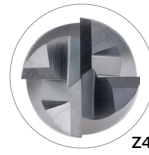
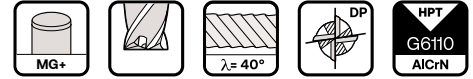

Order Number	Dimension (mm)					G6110	Order Number	Dimension (mm)					G6110
	D	l1	l2	L	d2 (h6)			D	l1	l2	L	d2 (h6)	
543 0100 050 04	1	3		50	4	◦							
543 0150 050 04	1.5	4.5		50	4	◦							
543 0200 050 04	2	6.5		50	4	◦							
543 0250 050 04	2.5			50	4	◦							
543 0300	3	9		40	3	•							
543 0300 050 06	3	12		50	6	◦							
543 0350 050 04	3.5			50	4	◦							
543 0400	4	15		50	4	•							
543 0400 050 06	4			50	6	•							
543 0450 050 05	4.5	20		50	5	•							
543 0500	5			50	5	•							
543 0500 050 06	5	25		50	6	◦							
543 0550 050 06	5.5			50	6	◦							
543 0600 050	6	32		50	6	•							
543 0600 060	6			60	6	•							
543 0700 064 08	7	38		64	8	◦							
543 0800	8			64	8	•							
543 0900 070 10	9	100		70	10	•							
543 1000 070	10			70	10	•							
543 1100 075 12	11	20		75	12	•							
543 1200	12			75	12	•							
543 1400	14	20		90	14	•							
543 1600	16			90	16	◦							
543 2000	20		100	20	◦								

* - DIN 6535

ALU LINE
 EZ LINE - ENDMILL
 SE 30
 NITICO 30
 OPTIMUM
 SE 45
SE 45X
 NITICO 45
 SE 60
 SE 60X
 DN70 - SE 70
 SE GR
 TE 45
 PLUNGE -MILL
 THREAD MILL

Material Group | Material-Gruppe | Groupe Matière | Gruppo Materiali | 材质主类

N01	N02	N03	K01	K02	P01	P02	P03	M01	M02	S01	S02	S03	H01	H02	O01	O02
-----	-----	-----	-----	-----	-----	-----	-----	-----	-----	-----	-----	-----	-----	-----	-----	-----

Cutting Parameter

237

Recommended Cutting Data



Note: These recommended cutting data indicators are just for reference. They should be adjusted according to the different cutting condition



SE 45X DP Endmills, 4 Flutes - 543, 635, 887, A06, A07

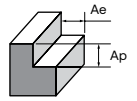

Side Milling	P		H	
Working Material	Prehardened steel		Hardened steel	
Properties	35 ≤ HRC < 45		45 ≤ HRC < 52	
Cutting depth, ap	1.20 × D		1.20 × D	
Cutting Width, ae	0.12 × D		0.10 × D	
D	Vc	Fz	Vc	Fz
1	130	0.007	100	0.006
2		0.016		0.014
3		0.025		0.023
4		0.035		0.033
5		0.046		0.044
6		0.060		0.058
8		0.085		0.082
10		0.112		0.107
12		0.142		0.136
14		0.156		0.151
16		0.167		0.162
20		0.194		0.188

ALU LINE
EZ LINE -
ENDMILL
SE 30
SE 30
NITCo 30
OPTIMUM
SE 45
SE 45X
NITCo 45
SE 60
SE 60X
DM70 -
SE70
SE GR
TE 45
PLUNGE
-MILL
THREAD
MILL

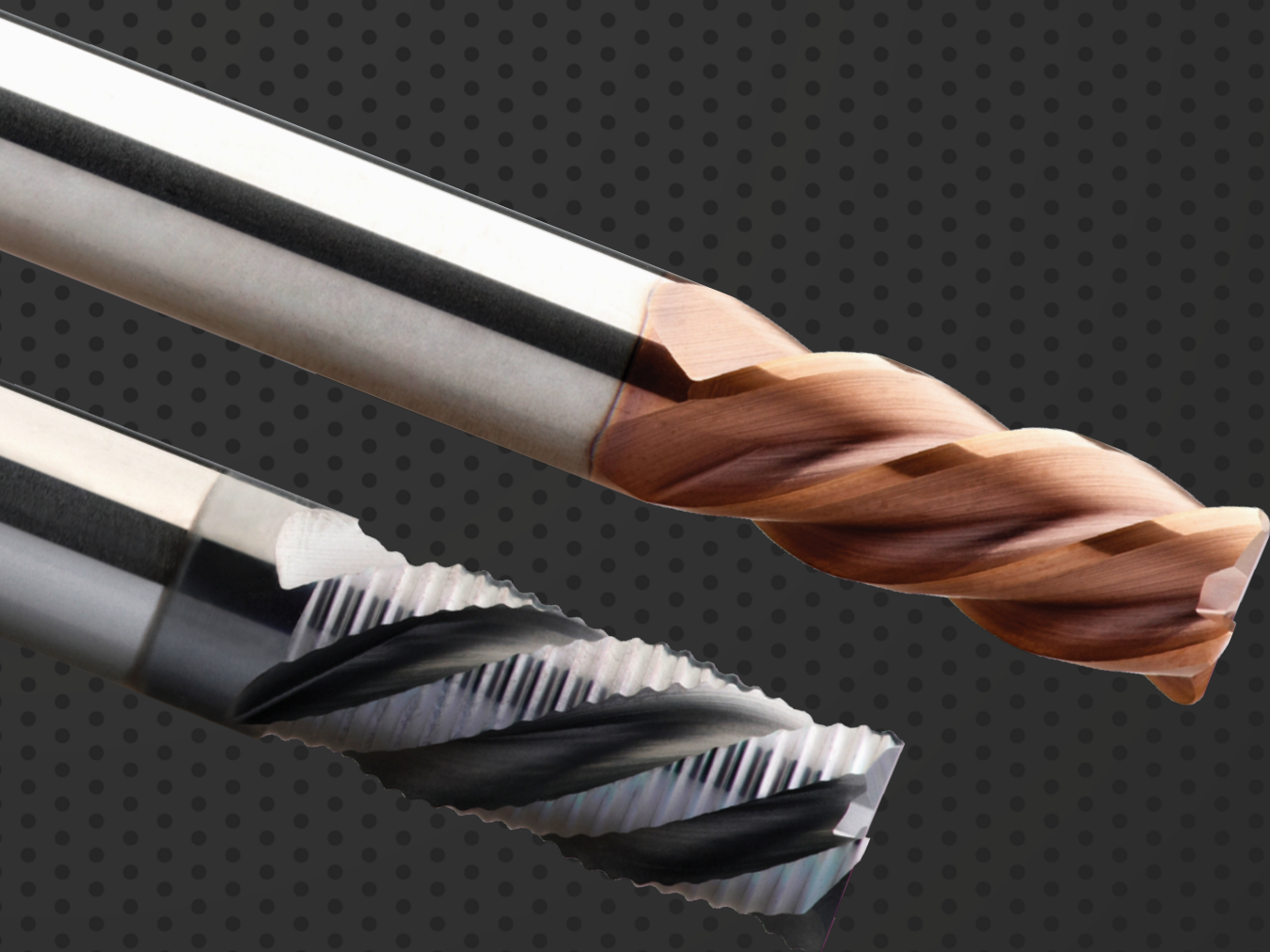

ENDMILLS

NiTiCo 45

No Vibration and Noise

For material application between 36 HRC to 52 HRC

Index NiTiCo 45, For 36 - 52 HRC

Suitable for Material Groups

Adapté pour les matériaux

适用于材料

Geeignet für die Materialgruppen

Adatto per il materiale



	EDP Number	Type	No. Z	Helix Angle	Coating	Performance	Page Number
NEW	K92	NiTiCo 45 DP/DH	4	$a^\circ \neq b^\circ$	B0909	P	242
NEW	K93	NiTiCo 45 DP/DH, Recess	4	$a^\circ \neq b^\circ$	B0909	P	242
NEW	K94	NiTiCo 45 DP/DH, Weldon	4	$a^\circ \neq b^\circ$	B0909	P	242
NEW	K95	NiTiCo 45 DP/DH, Recess, Weldon	4	$a^\circ \neq b^\circ$	B0909	P	242
NEW	K96	NiTiCo 45 DP/DH Torus	4	$a^\circ \neq b^\circ$	B0909	P	243
NEW	K97	NiTiCo 45 DP/DH Torus, Recess	4	$a^\circ \neq b^\circ$	B0909	P	243
NEW	K98	NiTiCo 45 DP/DH Torus, Weldon	4	$a^\circ \neq b^\circ$	B0909	P	243
NEW	K99	NiTiCo 45 DP/DH Torus, Recess, Weldon	4	$a^\circ \neq b^\circ$	B0909	P	243
	G38	NiTiCo 45 DP Roughing	4	40°	G6110	P	245
	G41	NiTiCo 45 DP Roughing, Recess	4	40°	G6110	P	245
	G44	DP Roughing, Weldon	4	40°	G6110	P	245
	G47	DP Roughing, Recess, Weldon	4	40°	G6110	P	245

G - General P - Performance

FEATURES & BENEFITS

NiTiCo 45 DP



Top View

1 Perfect Edge Grinding

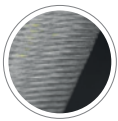

- Improves surface finishing
- Enables higher cutting speeds
- High CNC repeatability within 0.010mm

2 Differential Pitch (DP) Design



- Reduce Vibrations
- Maximizes productivity and tool life



3 PVD coating + coating selection

- Superior wear and chipping resistance due to optimally matched coating and carbide material
- Prolong the tool life
- Enables higher cutting speeds

4 Suitable for Material Groups





- Noviano (keine Vibration und Lärm)
1. Perfekter Kantenschliff
verbessert die Oberflächengüte
ermöglicht höhere Schnittgeschwindigkeiten
hohe CNC-Wiederholgenauigkeit innerhalb 0.01mm
- Exzentrischer Schliff
Perfekter Schliff der Schneidkante
2. Ungleiche Teilung (DP)
Reduziert Lärm und Vibrationen
 3. PVD-Beschichtung + Hartmetallsorte
ausgezeichnete Beständigkeit gegen Verschleiß und
Abplatzungen durch optimale Abstimmung von
Material und Beschichtung
verlängert die Lebensdauer des Werkzeugs
ermöglicht höhere Schnittgeschwindigkeiten
 4. Geeignet für die Materialgruppen P, M, K, S



- Noviano (无振动和噪音)
1. 完美的边刃研磨
改善表面光洁度。
实现更高的切削速率。
在 0.010mm 内数控系统可重复性高。
- 偏心研磨
完美的边刃研磨。
2. 可变指数
防震设计。
 3. PVD 涂层 + 碳化物硬质合金选择
由于涂层和碳化物材料的最佳匹配, 具有优异的耐磨性和耐
崩裂性。
延长刀具寿命。
实现更高的切削速率。
 4. 适用于材料 P、M、K、S



- Noviano (nessuna vibrazione e rumore)
1. Perfetta levigatura degli spigoli
Migliora la finitura superficiale
consente maggiori velocità di taglio
Elevata ripetibilità cnc entro 0,010 mm
- Levigatura orbitale
Perfetta levigatura degli spigoli
2. Indice variabile
Struttura antivibrazione
 3. Rivestimento PVD+selezione carburo
resistenza ad usura e scheggiatura superiore grazie
a rivestimento abbinato in modo ottimale e materiale
in carburi
prolunga la vita dello strumento
consente maggiori velocità di taglio
 4. Adatto per il materiale P, M, K, S



- Noviano (aucune vibration, aucun bruit)
1. Meulage parfait des arêtes
améliore la finition de surface
permet des vitesses de coupe supérieures
haute répétabilité de l'usinage sur CNC de 0,010 mm
- Index des variables
conception anti-vibrations
3. Revêtement sous forme de dépôt en phase vapeur +
sélection de carbure
Haute résistance à l'usure et à l'ecaillage, grâce au
revêtement en totale adéquation avec le carbure
prolonge la durée de vie de l'outil
permet des vitesses de coupe supérieures
 4. Adatto per il materiale P, M, K, S

K92 / K93 / K94 / K95 NEW



NITICO 45 DP/DH ENDMILLS / WITH RECESS, 4 FLUTES

- VHM NiTiCo 45 DP/DH Fräser, 4 Zähne
- Frese NiTiCo 45, con passo differenziale, elica variabile, 4 taglienti
- Fraises NiTiCo 45 DP/DH à pas décalés et hélices différentes, 4 dents
- 整体硬质合金 NiTiCo 45 DP/DH 系列 4刃平底铣刀

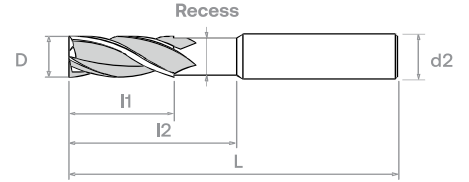
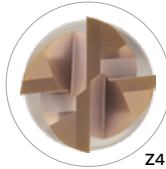
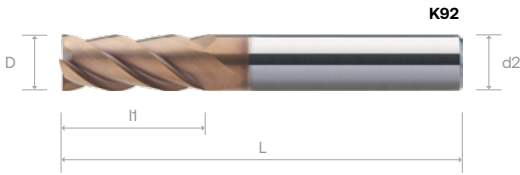
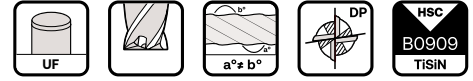

Order Number	Dimension (mm)					HA	B0909
	D	I1	I2	L	d2 (h6)		
K92 0300	3	8		57	6	•	
K92 0400	4	11		57	6	•	
K92 0500	5	13		57	6	•	
K92 0600	6			57	6	•	
K92 0800	8	19		63	8	•	
K92 1000	10	22		72	10	•	
K92 1200	12	26		83	12	•	
K92 1400	14			83	14	•	
K92 1600	16	32		92	16	•	
K92 1800	18			92	18	◦	
K92 2000	20	38		104	20	•	

Order Number	Dimension (mm)					HA	B0909
	D	I1	I2	L	d2 (h6)		
K93 0300	3	8	14	57	6	◦	
K93 0400	4	11	18	57	6	◦	
K93 0500	5	13	18	57	6	◦	
K93 0600	6		20	57	6	◦	
K93 0800	8	19	26	63	8	◦	
K93 1000	10	22	32	72	10	◦	
K93 1200	12	26	36	83	12	◦	
K93 1400	14		36	83	14	◦	
K93 1600	16	32	42	92	16	◦	
K93 1800	18		42	92	18	◦	
K93 2000	20	38	52	104	20	◦	

Order Number	Dimension (mm)					HB	B0909
	D	I1	I2	L	d2 (h6)		
K94 0300	3	8		57	6	◦	
K94 0400	4	11		57	6	◦	
K94 0500	5	13		57	6	◦	
K94 0600	6			57	6	◦	
K94 0800	8	19		63	8	◦	
K94 1000	10	22		72	10	◦	
K94 1200	12	26		83	12	◦	
K94 1400	14			83	14	◦	
K94 1600	16	32		92	16	◦	
K94 1800	18			92	18	◦	
K94 2000	20	38		104	20	◦	

Order Number	Dimension (mm)					HB	B0909
	D	I1	I2	L	d2 (h6)		
K95 0300	3	8	14	57	6	◦	
K95 0400	4	11	18	57	6	◦	
K95 0500	5	13	18	57	6	◦	
K95 0600	6		20	57	6	◦	
K95 0800	8	19	26	63	8	◦	
K95 1000	10	22	32	72	10	◦	
K95 1200	12	26	36	83	12	◦	
K95 1400	14		36	83	14	◦	
K95 1600	16	32	42	92	16	◦	
K95 1800	18		42	92	18	◦	
K95 2000	20	38	52	104	20	◦	

CNC Repeatability
 Ø1 - Ø3 within 10µm
 Ø4 - Ø8 within 15µm
 ≥ Ø10 within 20µm

Material Group | Material-Gruppe | Groupe Matière | Gruppo Materiali | 材质主类



Cutting Parameter

246

ALU LINE
 EZ LINE - ENDMILL
 SE 30
 NITICO 30
 OPTIMUM
 SE 45
 SE 45X
 NITICO 45
 SE 60
 SE 60X
 DN70 - SE 70
 SE GR
 TE 45
 PLUNGE -MILL
 THREAD MILL

K96 / K97 / K98 / K99

NEW



NITICO 45 DP/DH TORUS ENDMILLS / WITH RECESS, 4 FLUTES

- VHM NiTiCo 45 DP/DH Torusfräser, 4 Zähne
- Frese toroidali NiTiCo 45, con passo differenziale, elica variabile, 4 taglienti
- Fraises NiTiCo 45 DP/DH toriques à pas décalés et hélices différentes, 4 dents
- 整体硬质合金 NiTiCo 45 DP/DH 系列 4刃圆鼻铣刀

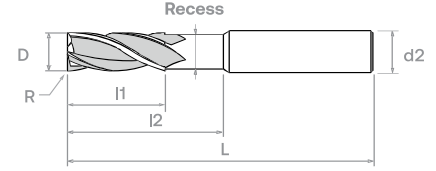
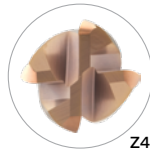

Order Number	Dimension (mm)						HA	B0909	Order Number	Dimension (mm)						HA	B0909
	D	I1	I2	L	d2 (h6)	R				D	I1	I2	L	d2 (h6)	R		
K96 0300 050 0600 030	3	8		57	6	0.3	•	K97 0300 050 0600 030	3	8	15	57	6	0.3	◦		
K96 0300 050 0600 050				57	6	0.5	•	K97 0300 050 0600 050				15	57	6	0.5	◦	
K96 0400 057 0600 030	4	11		57	6	0.3	•	K97 0400 057 0600 030	4	11	18	57	6	0.3	◦		
K96 0400 057 0600 050				57	6	0.5	•	K97 0400 057 0600 050				18	57	6	0.5	◦	
K96 0500 057 0600 100	5	13		57	6	1	•	K97 0500 057 0600 100	5	13	18	57	6	1	◦		
K96 0500 057 0600 030				57	6	0.3	•	K97 0500 057 0600 030				18	57	6	0.3	◦	
K96 0600 057 0600 050	6	13		57	6	0.3	•	K97 0600 057 0600 050	6	13	20	57	6	0.3	◦		
K96 0600 057 0600 100				57	6	0.5	•	K97 0600 057 0600 100				20	57	6	0.5	◦	
K96 0800 064 0800 030	8	19		57	6	1	•	K97 0800 064 0800 030	8	19	26	63	8	0.3	◦		
K96 0800 064 0800 050				63	8	0.3	•	K97 0800 064 0800 050				26	63	8	0.5	◦	
K96 0800 064 0800 100	8	19		63	8	0.5	•	K97 0800 064 0800 100	8	19	26	63	8	1	◦		
K96 0800 064 0800 150				63	8	1.5	•	K97 0800 064 0800 150				26	63	8	1.5	◦	
K96 0800 064 0800 200	10	22		63	8	2	•	K97 0800 064 0800 200	10	22	26	63	8	2	◦		
K96 1000 072 1000 030				72	10	0.3	•	K97 1000 072 1000 030				30	72	10	0.3	◦	
K96 1000 072 1000 050	10	22		72	10	0.5	•	K97 1000 072 1000 050	10	22	30	72	10	0.5	◦		
K96 1000 072 1000 100				72	10	1	•	K97 1000 072 1000 100				30	72	10	1	◦	
K96 1000 072 1000 150	10	22		72	10	1.5	•	K97 1000 072 1000 150	10	22	30	72	10	1.5	◦		
K96 1000 072 1000 200				72	10	2	•	K97 1000 072 1000 200				30	72	10	2	◦	
K96 1200 083 1200 030	12	26		72	10	2	•	K97 1200 083 1200 030	12	26	36	83	12	0.3	◦		
K96 1200 083 1200 050				83	12	0.3	•	K97 1200 083 1200 050				36	83	12	0.5	◦	
K96 1200 083 1200 100	12	26		83	12	0.5	•	K97 1200 083 1200 100	12	26	36	83	12	0.5	◦		
K96 1200 083 1200 150				83	12	1	•	K97 1200 083 1200 150				36	83	12	1	◦	
K96 1200 083 1200 200	12	26		83	12	2	•	K97 1200 083 1200 200	12	26	36	83	12	2	◦		
K96 1200 083 1200 250				83	12	2.5	◦	K97 1200 083 1200 250				36	83	12	2.5	◦	
K96 1400 083 1400 030	14	26		83	12	3	•	K97 1400 083 1400 030	14	26	36	83	12	3	◦		
K96 1400 083 1400 050				83	14	0.3	◦	K97 1400 083 1400 050				36	83	14	0.5	◦	
K96 1400 083 1400 100	14	26		83	14	0.5	◦	K97 1400 083 1400 100	14	26	36	83	14	1	◦		
K96 1400 083 1400 200				83	14	2	◦	K97 1400 083 1400 200				36	83	14	2	◦	
K96 1400 083 1400 300	16	32		83	14	3	•	K97 1400 083 1400 300	16	32	36	83	14	3	◦		
K96 1600 092 1600 030				92	16	0.3	◦	K97 1600 092 1600 030				42	92	16	0.3	◦	
K96 1600 092 1600 050	16	32		92	16	0.5	•	K97 1600 092 1600 050	16	32	42	92	16	0.5	◦		
K96 1600 092 1600 100				92	16	1	•	K97 1600 092 1600 100				42	92	16	1	◦	
K96 1600 092 1600 200	16	32		92	16	2	◦	K97 1600 092 1600 200	16	32	42	92	16	2	◦		
K96 1600 092 1600 250				92	16	2.5	◦	K97 1600 092 1600 250				42	92	16	2.5	◦	
K96 1600 092 1600 300	18	32		92	16	3	•	K97 1600 092 1600 300	18	32	42	92	16	3	◦		
K96 1600 092 1600 400				92	16	4	◦	K97 1600 092 1600 400				42	92	16	4	◦	
K96 1800 092 1800 030	18	32		92	18	0.3	◦	K97 1800 092 1800 030	18	32	42	92	18	0.3	◦		
K96 1800 092 1800 050				92	18	0.5	◦	K97 1800 092 1800 050				42	92	18	0.5	◦	
K96 1800 092 1800 100	18	32		92	18	1	◦	K97 1800 092 1800 100	18	32	42	92	18	1	◦		
K96 1800 092 1800 200				92	18	2	◦	K97 1800 092 1800 200				42	92	18	2	◦	
K96 1800 092 1800 300	20	38		92	18	3	◦	K97 1800 092 1800 300	20	38	42	92	18	3	◦		
K96 2000 104 2000 030				104	20	0.3	◦	K97 2000 104 2000 030				52	104	20	0.3	◦	
K96 2000 104 2000 050	20	38		104	20	0.5	◦	K97 2000 104 2000 050	20	38	52	104	20	0.5	◦		
K96 2000 104 2000 100				104	20	1	•	K97 2000 104 2000 100				52	104	20	1	◦	
K96 2000 104 2000 200	20	38		104	20	2	◦	K97 2000 104 2000 200	20	38	52	104	20	2	◦		
K96 2000 104 2000 250				104	20	2.5	◦	K97 2000 104 2000 250				52	104	20	2.5	◦	
K96 2000 104 2000 300	20	38		104	20	3	◦	K97 2000 104 2000 300	20	38	52	104	20	3	◦		
K96 2000 104 2000 400				104	20	4	◦	K97 2000 104 2000 400				52	104	20	4	◦	

cont'd ▶

CNC Repeatability

Ø1 - Ø3 within 10µm

Ø4 - Ø8 within 15µm

≥ Ø10 within 20µm

Material Group | Material-Gruppe | Groupe Matiere | Gruppo Materiali | 材质主类

Cutting Parameter

N01	N02	N03	K01	K02	P01	P02	P03	M01	M02	S01	S02	S03	H01	H02	O01	O02	247
-----	-----	-----	-----	-----	-----	-----	-----	-----	-----	-----	-----	-----	-----	-----	-----	-----	-----

K96 / K97 / K98 / K99 NEW



NITICO 45 DP/DH TORUS ENDMILLS / WITH RECESS, 4 FLUTES

- VHM NiTiCo 45 DP/DH Torusfräser, 4 Zähne
- Frese toroidali NiTiCo 45, con passo differenziale, elica variabile, 4 taglienti
- Fraises NiTiCo 45 DP/DH toriques à pas décalés et hélices différentes, 4 dents
- 整体硬质合金 NiTiCo 45 DP/DH 系列 4刃圆鼻铣刀

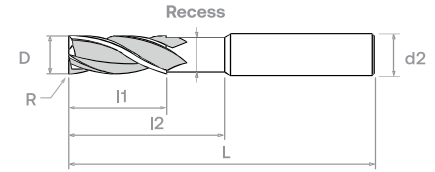
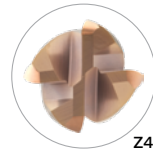
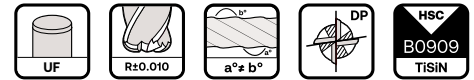

Order Number	Dimension (mm)						HB	B0909	Order Number	Dimension (mm)						HB	B0909
	D	l1	l2	L	d2 (h6)	R				D	l1	l2	L	d2 (h6)	R		
K98 0300 050 0600 030	3	8		57	6	0.3	°	K99 0300 050 0600 030	3	8	15	57	6	0.3	°		
K98 0300 050 0600 050			57	6	0.5	°	K99 0300 050 0600 050	15			57	6	0.5	°			
K98 0400 057 0600 030	4	11		57	6	0.3	°	K99 0400 057 0600 030	4	11	18	57	6	0.3	°		
K98 0400 057 0600 050			57	6	0.5	°	K99 0400 057 0600 050	18			57	6	0.5	°			
K98 0500 057 0600 100	5	13		57	6	1	°	K99 0500 057 0600 100	5	13	18	57	6	1	°		
K98 0500 057 0600 030			57	6	0.3	°	K99 0500 057 0600 030	18			57	6	0.3	°			
K98 0500 057 0600 050	6	13		57	6	0.5	°	K99 0500 057 0600 050	6	13	18	57	6	0.5	°		
K98 0600 057 0600 030			57	6	0.3	°	K99 0600 057 0600 030	20			57	6	0.3	°			
K98 0600 057 0600 050	8	19		57	6	0.5	°	K99 0600 057 0600 050	8	19	20	57	6	0.5	°		
K98 0600 057 0600 100			57	6	1	°	K99 0600 057 0600 100	20			57	6	1	°			
K98 0800 064 0800 030	10	22		63	8	0.3	°	K99 0800 064 0800 030	10	22	26	63	8	0.3	°		
K98 0800 064 0800 050			63	8	0.5	°	K99 0800 064 0800 050	26			63	8	0.5	°			
K98 0800 064 0800 100	12	26		63	8	1	°	K99 0800 064 0800 100	12	26	26	63	8	1	°		
K98 0800 064 0800 150			63	8	1.5	°	K99 0800 064 0800 150	26			63	8	1.5	°			
K98 0800 064 0800 200	14	26		63	8	2	°	K99 0800 064 0800 200	14	26	26	63	8	2	°		
K98 1000 072 1000 030			72	10	0.3	°	K99 1000 072 1000 030	30			72	10	0.3	°			
K98 1000 072 1000 050	16	32		72	10	0.5	°	K99 1000 072 1000 050	16	32	30	72	10	0.5	°		
K98 1000 072 1000 100			72	10	1	°	K99 1000 072 1000 100	30			72	10	1	°			
K98 1000 072 1000 150	18	32		72	10	1.5	°	K99 1000 072 1000 150	18	32	30	72	10	1.5	°		
K98 1000 072 1000 200			72	10	2	°	K99 1000 072 1000 200	30			72	10	2	°			
K98 1200 083 1200 030	20	38		83	12	0.3	°	K99 1200 083 1200 030	20	38	36	83	12	0.3	°		
K98 1200 083 1200 050			83	12	0.5	°	K99 1200 083 1200 050	36			83	12	0.5	°			
K98 1200 083 1200 100	24	46		83	12	1	°	K99 1200 083 1200 100	24	46	36	83	12	1	°		
K98 1200 083 1200 200			83	12	2	°	K99 1200 083 1200 200	36			83	12	2	°			
K98 1200 083 1200 250	26	54		83	12	2.5	°	K99 1200 083 1200 250	26	54	36	83	12	2.5	°		
K98 1200 083 1200 300			83	12	3	°	K99 1200 083 1200 300	36			83	12	3	°			
K98 1400 083 1400 030	30	66		83	14	0.3	°	K99 1400 083 1400 030	30	66	36	83	14	0.3	°		
K98 1400 083 1400 050			83	14	0.5	°	K99 1400 083 1400 050	36			83	14	0.5	°			
K98 1400 083 1400 100	36	78		83	14	1	°	K99 1400 083 1400 100	36	78	36	83	14	1	°		
K98 1400 083 1400 200			83	14	2	°	K99 1400 083 1400 200	36			83	14	2	°			
K98 1400 083 1400 300	42	90		83	14	3	°	K99 1400 083 1400 300	42	90	36	83	14	3	°		
K98 1600 092 1600 030			92	16	0.3	°	K99 1600 092 1600 030	42			92	16	0.3	°			
K98 1600 092 1600 050	48	102		92	16	0.5	°	K99 1600 092 1600 050	48	102	42	92	16	0.5	°		
K98 1600 092 1600 100			92	16	1	°	K99 1600 092 1600 100	42			92	16	1	°			
K98 1600 092 1600 200	54	114		92	16	2	°	K99 1600 092 1600 200	54	114	42	92	16	2	°		
K98 1600 092 1600 250			92	16	2.5	°	K99 1600 092 1600 250	42			92	16	2.5	°			
K98 1600 092 1600 300	60	126		92	16	3	°	K99 1600 092 1600 300	60	126	42	92	16	3	°		
K98 1600 092 1600 400			92	16	4	°	K99 1600 092 1600 400	42			92	16	4	°			
K98 1800 092 1800 030	66	138		92	18	0.3	°	K99 1800 092 1800 030	66	138	42	92	18	0.3	°		
K98 1800 092 1800 050			92	18	0.5	°	K99 1800 092 1800 050	42			92	18	0.5	°			
K98 1800 092 1800 100	72	150		92	18	1	°	K99 1800 092 1800 100	72	150	42	92	18	1	°		
K98 1800 092 1800 200			92	18	2	°	K99 1800 092 1800 200	42			92	18	2	°			
K98 1800 092 1800 300	78	162		92	18	3	°	K99 1800 092 1800 300	78	162	42	92	18	3	°		
K98 2000 104 2000 030			92	18	0.3	°	K99 2000 104 2000 030	52			104	20	0.3	°			
K98 2000 104 2000 050	84	174		104	20	0.5	°	K99 2000 104 2000 050	84	174	52	104	20	0.5	°		
K98 2000 104 2000 100			104	20	1	°	K99 2000 104 2000 100	52			104	20	1	°			
K98 2000 104 2000 200	90	186		104	20	2	°	K99 2000 104 2000 200	90	186	52	104	20	2	°		
K98 2000 104 2000 250			104	20	2.5	°	K99 2000 104 2000 250	52			104	20	2.5	°			
K98 2000 104 2000 300	96	198		104	20	3	°	K99 2000 104 2000 300	96	198	52	104	20	3	°		
K98 2000 104 2000 400			104	20	4	°	K99 2000 104 2000 400	52			104	20	4	°			

ALU LINE
 EZ LINE - ENDMILL
 SE 30
 NITICO 30
 OPTIMUM
 SE 45
 SE 45X
 NITICO 45
 SE 60
 SE 60X
 DN70 - SE70
 SE GR
 TE 45
 PLUNGE -MILL
 THREAD MILL

CNC Repeatability	
Ø1 - Ø3	within 10µm
Ø4 - Ø8	within 15µm
≥ Ø10	within 20µm

Material Group | Material-Gruppe | Groupe Matière | Gruppo Materiali | 材质主类

N01
N02
N03
K01
K02
P01
P02
P03
M01
M02
S01
S02
S03
H01
H02
O01
O02

Cutting Parameter

247

G38 / G41 / G44 / G47 NEW



NITICO 45 DP ROUGHING ENDMILLS / WITH WELDON, 4 FLUTES

- VHM NiTiCo 45 DP Schrumpfpräser, 4 Zähne
- Frese per sgrossare NiTiCo 45, con passo differenziale, 4 taglienti
- Fraises ébauches NiTiCo 45 DP à pas décalés - 4 dents
- 整体硬质合金 NiTiCo 45 DP 系列 4刃粗加工平底铣刀

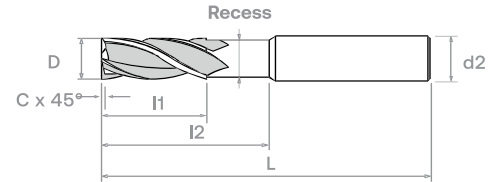
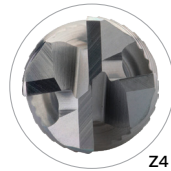

Order Number	Dimension (mm)						HA	G6110
	D	I1	I2	L	d2 (h6)	C		
G38 0600	6	13		57	6	0.1	°	
G38 0800	8	20		64	8	0.2	°	
G38 1000	10	22		72	10	0.2	•	
G38 1200	12	26		83	12	0.2	•	
G38 1400	14		83	14	0.3	°		
G38 1600	16	32		92	16	0.3	°	
G38 1800	18		92	18	0.3	°		
G38 2000	20	38		104	20	0.4	°	

Order Number	Dimension (mm)						HA	G6110
	D	I1	I2	L	d2 (h6)	C		
G41 0600 *	6	13	20	57	6	0.1	°	
G41 0800	8	20	30	64	8	0.2	°	
G41 1000 *	10	22	32	72	10	0.2	°	
G41 1200 *	12	26	37	83	12	0.2	°	
G41 1400	14		44	83	14	0.3	°	
G41 1600	16	32	46	92	16	0.3	°	
G41 1800	18		53	92	18	0.3	°	
G41 2000	20	38	58	104	20	0.4	°	

Order Number	Dimension (mm)						HB	G6110
	D	I1	I2	L	d2 (h6)	C		
G44 0600	6	13		57	6	0.1	•	
G44 0800	8	20		64	8	0.2	°	
G44 1000	10	22		72	10	0.2	•	
G44 1200	12	26		83	12	0.2	°	
G44 1400	14		83	14	0.3	°		
G44 1600	16	32		92	16	0.3	°	
G44 1800	18		92	18	0.3	°		
G44 2000	20	38		104	20	0.4	•	

Order Number	Dimension (mm)						HB	G6110
	D	I1	I2	L	d2 (h6)	C		
G47 0600 *	6	13	20	57	6	0.1	°	
G47 0800	8	20	30	64	8	0.2	°	
G47 1000 *	10	22	32	72	10	0.2	°	
G47 1200 *	12	26	37	83	12	0.2	°	
G47 1400	14		44	83	14	0.3	°	
G47 1600	16	32	46	92	16	0.3	°	
G47 1800	18		53	92	18	0.3	°	
G47 2000	20	38	58	104	20	0.4	°	

* - DIN 6535

Material Group | Material-Gruppe | Groupe Matière | Gruppo Materiali | 材质主类

Cutting Parameter

N01	N02	N03	K01	K02	P01	P02	P03	M01	M02	S01	S02	S03	H01	H02	O01	O02	248
-----	-----	-----	-----	-----	-----	-----	-----	-----	-----	-----	-----	-----	-----	-----	-----	-----	-----

ALU LINE
 EZ LINE - ENDMILL
 SE 30
 NITICO 30
 OPTIMUM
 SE 45
 SE 45X
 NITICO 45
 SE 60
 SE 60X
 DM70 - SE70
 SE GR
 TE 45
 PLUNGE -MILL
 THREAD MILL

Recommended Cutting Data



Note: These recommended cutting data indicators are just for reference. They should be adjusted according to the different cutting condition



NiTiCo 45 Endmills, 4 Flutes - K92, K93, K94, K95

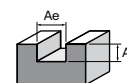

Slotting	K		P		M		S	
Working Material	Ductile Cast Iron		Prehardened steel		Stainless steel		Nickel Alloy	
Properties	-		35 ≤ HRC < 45		Low Machinability		-	
Cutting depth, ap	0.80 x D		0.80 x D		0.45 x D		0.30 x D	
Cutting Width, ae	1.00 x D		1.00 x D		1.00 x D		1.00 x D	
D	Vc	Fz	Vc	Fz	Vc	Fz	Vc	Fz
3	80	0.012	100	0.013	55	0.014	25	0.011
4		0.017		0.018		0.018		0.015
5		0.022		0.023		0.023		0.019
6		0.027		0.028		0.029		0.024
8		0.036		0.038		0.039		0.032
10		0.046		0.049		0.050		0.043
12		0.057		0.059		0.061		0.054
14		0.065		0.069		0.070		0.060
16		0.073		0.077		0.078		0.065
18		0.081		0.086		0.087		0.073
20	0.088	0.095	0.095	0.079				

NiTiCo 45 Endmills, 4 Flutes - K92, K93, K94, K95

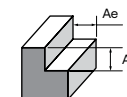

Side Milling	K		P		M		S	
Working Material	Ductile Cast Iron		Prehardened steel		Stainless steel		Nickel Alloy	
Properties	-		35 ≤ HRC < 45		Low Machinability		-	
Cutting depth, ap	1.00 x D		1.00 x D		1.00 x D		1.00 x D	
Cutting Width, ae	0.18 x D		0.18 x D		0.18 x D		0.10 x D	
D	Vc	Fz	Vc	Fz	Vc	Fz	Vc	Fz
3	90	0.014	120	0.014	70	0.016	35	0.014
4		0.019		0.021		0.023		0.019
5		0.026		0.027		0.029		0.024
6		0.031		0.032		0.035		0.030
8		0.043		0.045		0.048		0.041
10		0.055		0.058		0.062		0.052
12		0.068		0.072		0.078		0.067
14		0.077		0.081		0.088		0.076
16		0.087		0.090		0.098		0.084
18		0.095		0.099		0.106		0.094
20	0.102	0.108	0.113	0.101				

ALU LINE
 EZ LINE -
 ENDMILL
 SE 30
 NITICO 30
 OPTIMUM
 SE 45
 SE 45X
 NITICO 45
 SE 60
 SE 60X
 DN70 -
 SE 70
 SE GR
 TE 45
 PLUNGE
 -MILL
 THREAD
 MILL

Recommended Cutting Data



Note: These recommended cutting data indicators are just for reference. They should be adjusted according to the different cutting condition



NiTiCo 45 Torus Endmills, 4 Flutes - K96, K97, K98, K99

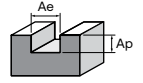

Slotting	K		P		M		S	
Working Material	Ductile Cast Iron		Prehardened steel		Stainless steel		Nickel Alloy	
Properties	-		35 ≤ HRC < 45		Low Machinability		-	
Cutting depth, ap	0.80 x D		0.80 x D		0.45 x D		0.30 x D	
Cutting Width, ae	1.00 x D		1.00 x D		1.00 x D		1.00 x D	
D	Vc	Fz	Vc	Fz	Vc	Fz	Vc	Fz
3	100	0.012	125	0.013	70	0.013	30	0.011
4		0.017		0.018		0.018		0.016
5		0.022		0.023		0.024		0.020
6		0.027		0.028		0.029		0.027
8		0.036		0.038		0.039		0.036
10		0.046		0.049		0.049		0.047
12		0.057		0.059		0.060		0.056
14		0.065		0.070		0.069		0.066
16		0.073		0.078		0.077		0.071
18		0.082		0.087		0.087		0.080
20	0.090	0.094	0.097	0.089				

NiTiCo 45 Torus Endmills, 4 Flutes - K96, K97, K98, K99

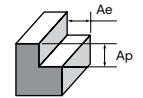

Side Milling	K		P		M		S	
Working Material	Ductile Cast Iron		Prehardened steel		Stainless steel		Nickel Alloy	
Properties	-		35 ≤ HRC < 45		Low Machinability		-	
Cutting depth, ap	1.00 x D		1.00 x D		1.00 x D		1.00 x D	
Cutting Width, ae	0.18 x D		0.18 x D		0.18 x D		0.10 x D	
D	Vc	Fz	Vc	Fz	Vc	Fz	Vc	Fz
3	110	0.014	150	0.014	85	0.017	45	0.013
4		0.019		0.021		0.023		0.019
5		0.026		0.027		0.030		0.024
6		0.032		0.032		0.036		0.029
8		0.045		0.045		0.050		0.041
10		0.056		0.058		0.064		0.051
12		0.070		0.072		0.081		0.067
14		0.079		0.081		0.091		0.074
16		0.089		0.091		0.102		0.081
18		0.097		0.099		0.112		0.091
20	0.104	0.109	0.117	0.101				

ALU LINE
ENDMILL -
SE 30
NITICO 30
OPTIMUM
SE 45
SE 45X
NITICO 45
SE 60
SE 60X
DM70 -
SE 70
SE GR
TE 45
PLUNGE
-MILL
THREAD
MILL

Recommended Cutting Data



Note: These recommended cutting data indicators are just for reference. They should be adjusted according to the different cutting condition



NiTiCo 45 Roughing Endmills, 4 Flutes - G38, G41, G44, G47

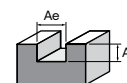

Slotting	K		P		M		S	
Working Material	Ductile Cast Iron		Prehardened steel		Stainless steel		Nickel Alloy	
Properties	-		35 ≤ HRC < 45		Low Machinability		-	
Cutting depth, ap	0.80 x D		0.80 x D		0.45 x D		0.30 x D	
Cutting Width, ae	1.00 x D		1.00 x D		1.00 x D		1.00 x D	
D	Vc	Fz	Vc	Fz	Vc	Fz	Vc	Fz
6	90	0.033	115	0.034	55	0.035	35	0.030
8		0.044		0.046		0.048		0.040
10		0.056		0.059		0.061		0.052
12		0.069		0.073		0.075		0.065
14		0.079		0.084		0.086		0.072
16		0.089		0.095		0.096		0.079
18		0.099		0.106		0.108		0.089
20		0.108		0.116		0.116		0.098

NiTiCo 45 Roughing Endmills, 4 Flutes - G38, G41, G44, G47

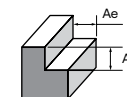

Side Milling	K		P		M		S	
Working Material	Ductile Cast Iron		Prehardened steel		Stainless steel		Nickel Alloy	
Properties	-		35 ≤ HRC < 45		Low Machinability		-	
Cutting depth, ap	1.00 x D		1.00 x D		1.00 x D		1.00 x D	
Cutting Width, ae	0.18 x D		0.18 x D		0.18 x D		0.10 x D	
D	Vc	Fz	Vc	Fz	Vc	Fz	Vc	Fz
6	100	0.038	130	0.041	65	0.043	45	0.037
8		0.053		0.055		0.058		0.051
10		0.066		0.070		0.076		0.063
12		0.083		0.088		0.096		0.081
14		0.093		0.099		0.108		0.092
16		0.105		0.110		0.119		0.101
18		0.115		0.121		0.129		0.113
20		0.125		0.132		0.139		0.122

ALU LINE
 EZ LINE -
 ENDMILL
 SE 30
 NITICO 30
 OPTIMUM
 SE 45
 SE 45X
 NITICO 45
 SE 60
 SE 60X
 DN70 -
 SE 70
 SE GR
 TE 45
 PLUNGE
 -MILL
 THREAD
 MILL



ENDMILLS

SE 60











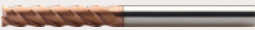





For general machining

For material application between 53 HRC to 68 HRC

Index SE 60, For 53 – 68 HRC

 Suitable for Material Groups
  Adapté pour les matériaux
  适用于材料
 Geeignet für die Materialgruppen
  Adatto per il materiale

H

EDP Number	Type	No. Z	Helix Angle	Coating	Performance	Page Number
A36	 SE 60 Long	4	40°	B0909	G	253
A37	 SE 60 Extra-Long	4	40°	B0909	G	254
A38	 SE 60 Long Reach Long	4	40°	B0909	G	255
A39	 SE 60 Long Reach Long	4	40°	B0909	G	255
A40	 SE 60 Long Reach Extra-Long	4	40°	B0909	G	256
A41	 SE 60 Long Reach Extra-Long	4	40°	B0909	G	256
A44	 SE 60 Multiflute Long	6/8	50°	B0909	G	257
A45	 SE 60 Multiflute Long	6/8	50°	B0909	G	257
A46	 SE 60 Multiflute Extra-Long	6/8	50°	B0909	G	258
A47	 SE 60 Multiflute Extra-Long	6/8	50°	B0909	G	258
A34	 SE 60 Short Flute	4	45°	B0909	G	259
A48	 SE 60R Short Flute	4	45°	B0909	G	260
A49	 SE 60R Short Flute	4	45°	B0909	G	260
A51	 SE 60R Long Reach Long	4	40°	B0909	G	261
A52	 SE 60R Long Reach Long	4	40°	B0909	G	261
A53	 SE 60R Long Reach Extra-Long	4	40°	B0909	G	262
A54	 SE 60R Long Reach Extra-Long	4	40°	B0909	G	262
A55	 SE 60 Mini	2	40°	B0909	G	263

G - General P - Performance

FEATURES & BENEFITS

SE 60



Top View

1 Gash Land Design



Significantly improves strength and provide great chipping resistance

2 Eccentric Grinding

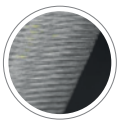

Optimum eccentric grinding in order to avoid rubbing, while maintaining maximum cutting tool strength.



3 Cutting Edge Preparation



- Enhances tool life
- Less material adhere on the cutting edge for stable machining
- Improves wear resistance and reduces excessive friction

4 Suitable for Material Group

H



1. Stirnschliff Design
Verbessert die Leistung deutlich und bietet Schutz gegen Ausbrüche
2. Exzentrischer Schliff
Optimaler exzentrischer Schliff zur Reduzierung der Reibung unter Beibehaltung der maximalen Schneidenstabilität
3. Schneidkantenbehandlung
Verbessert die Werkzeuglebensdauer
Weniger Materialanhaftungen an der Schneide Für stabile Bearbeitung
Verbessert die Verschleißfestigkeit und reduziert übermäßige Reibung
4. Negativer Spanwinkel
Geeignet für das Materialgruppe H



1. 底刃斜面式设计
显著提高强度, 提供极好的耐崩裂性。
2. 偏心研磨
最佳偏心研磨, 可避免摩擦, 同时保持最大切削刀具强度。
3. 切削刃设置提高刀具寿命
提高刀具寿命。
切削刃上的材料附着少, 加工稳定。
提高耐磨性并减少过度摩擦。
4. 负前角
适用于材料 H。



1. Struttura area sgrossatura
Migliora notevolmente la potenza e offre un'eccellente resistenza alle scheggiature
2. Levigatura orbitale
Levigatura orbitale ottimale per evitare sfregatura, garantendo la massima resistenza dello strumento di taglio.
3. Preparazione dell'angolo di taglio
Migliora la durata dello strumento
Meno materiale che aderisce sull'angolo di taglio
Per una lavorazione stabile
Migliora la resistenza all'usura e riduce l'attrito eccessivo
4. Angolo di taglio negativo
Adatto per il materiale H



1. Conception de fraise pour l'usinage general
Améliore considérablement la solidité et apporte une excellente résistance à l'ébarbage
2. Meulage excentrique
Meulage optimal diminuant le coefficient de friction tout en maintenant une bonne acuité de l'arête de coupe
3. Préparation des arêtes de coupes
Améliore la durée de vie de l'outil
Moins de matériau adhère à l'arête tranchante
Pour un usinage stable
Améliore la résistance à l'usure et réduit les frottements excessifs
4. Angle de coupe négatif
Adapté pour les matériaux H

SE 60 LONG ENDMILLS, 4 FLUTES

- VHM Fräser SE 60, lang, 4 Zähne
- Frese lunghe SE 60, 4 taglienti
- Fraises SE 60 Longue, 4 dents
- 整体硬质合金 SE 60 系列 4刃长型平底铣刀



Order Number	Dimension (mm)					B0909
	D	I 1	I 2	L	d2 (h6)	
A36 0300 075 06	3	19		75	6	•
A36 0400 075 06	4			75	6	•
A36 0500	5			60	5	•
A36 0500 075 06			75	6	•	
A36 0600	6	31		75	6	•
A36 0800	8			75	8	•
A36 1000 075	10			75	10	•
A36 1000 100			100	10	•	
A36 1200	12	50		100	12	•
A36 1400	14			125	14	•
A36 1600	16	57		125	16	•
A36 1800	18			125	18	•
A36 2000	20			125	20	•

ALU LINE
 EZ LINE - ENDMILL
 SE 30
 NITCo 30
 OPTIMUM
 SE 45
 SE 45X
 NITCo 45
 SE 60
 SE 60X
 DM70 - SE70
 SE GR
 TE 45
 PLUNGE -MILL
 THREAD MILL

Material Group | Material-Gruppe | Groupe Matière | Gruppo Materiali | 材质主类

Cutting Parameter

N01	N02	N03	K01	K02	P01	P02	P03	M01	M02	S01	S02	S03	H01	H02	O01	O02	264
-----	-----	-----	-----	-----	-----	-----	-----	-----	-----	-----	-----	-----	-----	-----	-----	-----	-----

SE 60 EXTRA-LONG ENDMILLS, 4 FLUTES

- VHM SE 60 Fräser, extra-lang, 4 Zähne
- Frese extra-lunghe SE 60, 4 taglienti
- Fraises SE 60 Extra-Longue- 4 dents
- 整体硬质合金 SE 60 系列 4刃加长型平底铣刀



Order Number	Dimension (mm)					B0909
	D	l1	l2	L	d2 (h6)	
A37 0300 100 06	3	25		100	6	•
A37 0400 100 06	4	31		100	6	•
A37 0500 100 06	5			100	6	•
A37 0600	6			100	6	•
A37 0800	8	41		100	8	•
A37 1000	10	57		125	10	•
A37 1200	12	75		150	12	•
A37 1400	14			150	14	•
A37 1600	16			150	16	•
A37 1800	18			150	18	•
A37 2000	20			150	20	•

- ALL LINE
- EZ LINE - ENDMILL
- SE 30
- NITICO 30
- OPTIMUM
- SE 45
- SE 45X
- NITICO 45
- SE 60**
- SE 60X
- DM70 - SE70
- SE GR
- TE 45
- PLUNGE -MILL
- THREAD MILL

Material Group | Material-Gruppe | Groupe Matière | Gruppo Materiali | 材质主类

Cutting Parameter

N01	N02	N03	K01	K02	P01	P02	P03	M01	M02	S01	S02	S03	H01	H02	O01	O02	264
-----	-----	-----	-----	-----	-----	-----	-----	-----	-----	-----	-----	-----	-----	-----	-----	-----	-----

SE 60 LONG, LONG REACH ENDMILLS WITH SHORT FLUTES / WITH RECESS, 4 FLUTES

- VHM SE 60 LONG REACH Fräser, lang, mit kurzen Nuten, 4 Zähne
- Frese lunghe SE 60 long-reach, con taglienti corti, 4 taglienti
- Fraises SE 60 LONG REACH longues à hélices courtes, 4 dents
- 整体硬质合金 SE 60 系列 4 刃长型长颈短刃平底铣刀

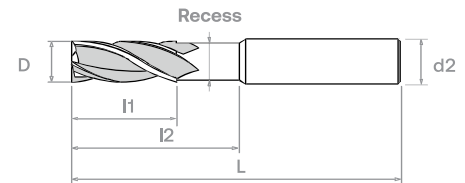
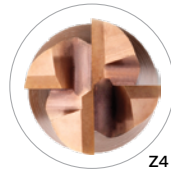
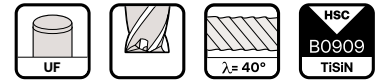

Order Number	Dimension (mm)					B0909	Order Number	Dimension (mm)					B0909
	D	l1	l2	L	d2 (h6)			D	l1	l2	L	d2 (h6)	
A38 0300 075 06	3	5		75	6	•	A39 0300 075 06	3	5	30	75	6	•
A38 0400 075 06	4	8		75	6	•	A39 0400 075 06	4	8	32	75	6	•
A38 0500 075 06	5	9		75	6	•	A39 0500 075 06	5	9	32	75	6	•
A38 0600	6	10		75	6	•	A39 0600	6	10	40	75	6	•
A38 0800	8	12		75	8	•	A39 0800	8	12	40	75	8	•
A38 1000 075	10	14		75	10	•	A39 1000 075	10	14	40	75	10	•
A38 1000 100			100	10	•	A39 1000 100	60			100	10	•	
A38 1200	12	16		100	12	•	A39 1200	12	16	60	100	12	•
A38 1400	14	22		125	14	•	A39 1400	14	22	85	125	14	•
A38 1600	16		125	16	•	A39 1600	16	85		125	16	•	
A38 1800	18	26		125	18	•	A39 1800	18	26	85	125	18	•
A38 2000	20		125	20	•	A39 2000	20	85		125	20	•	

Material Group | Material-Gruppe | Groupe Matière | Gruppo Materiali | 材质主类

Cutting Parameter

N01	N02	N03	K01	K02	P01	P02	P03	M01	M02	S01	S02	S03	H01	H02	O01	O02	265
-----	-----	-----	-----	-----	-----	-----	-----	-----	-----	-----	-----	-----	-----	-----	-----	-----	-----

SE 60 EXTRA-LONG, LONG REACH ENDMILLS, WITH SHORT FLUTES / WITH RECESS, 4 FLUTES

- VHM SE 60 LONG REACH Fräser, extra-lang, mit kurzen Nuten, 4 Zähne
- Frese extra-lunghe SE 60 long-reach, con taglienti corti, 4 taglienti
- Fraises SE 60 LONG REACH extra-longues à hélices courtes, 4 dents
- 整体硬质合金 SE 60 系列 4刃加长型长颈短刃平底铣刀

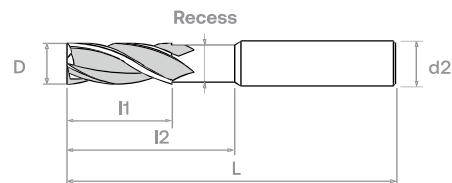
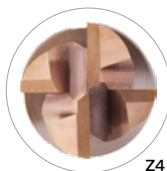

Order Number	Dimension (mm)					B0909	Order Number	Dimension (mm)					B0909
	D	l1	l2	L	d2 (h6)			D	l1	l2	L	d2 (h6)	
A40 0300 100 06	3	5		100	6	•	A41 0300 100 06	3	5	60	100	6	•
A40 0400 100 06	4	8		100	6	•	A41 0400 100 06	4	8	60	100	6	•
A40 0500 100 06	5	9		100	6	•	A41 0500 100 06	5	9	60	100	6	•
A40 0600	6	10		100	6	•	A41 0600	6	10	60	100	6	•
A40 0800	8	12		100	8	•	A41 0800	8	12	60	100	8	•
A40 1000	10	14		125	10	•	A41 1000	10	14	85	125	10	•
A40 1200	12	16		150	12	•	A41 1200	12	16	110	150	12	•
A40 1400	14	22		150	14	•	A41 1400	14	22	110	150	14	•
A40 1600	16			150	16	•	A41 1600	16		110	150	16	•
A40 1800	18	26		150	18	•	A41 1800	18	26	110	150	18	•
A40 2000	20			150	20	•	A41 2000	20		110	150	20	•

ALU LINE
 EZ LINE -
 ENDMILL
 SE 30
 NITICO 30
 OPTIMUM
 SE 45
 SE 45X
 NITICO 45
SE 60
 SE 60X
 DN70 -
 SE 70
 SE GR
 TE 45
 PLUNGE
 -MILL
 THREAD
 MILL

Material Group | Material-Gruppe | Groupe Matière | Gruppo Materiali | 材质主类

Cutting Parameter

N01	N02	N03	K01	K02	P01	P02	P03	M01	M02	S01	S02	S03	H01	H02	O01	O02
-----	-----	-----	-----	-----	-----	-----	-----	-----	-----	-----	-----	-----	-----	-----	-----	-----

266

A44 / A45



SE 60 LONG MULTIFLUTE ENDMILLS / WITH RECESS, 6 - 8 FLUTES

- VHM SE 60 Mehrzahnfräser, lang, 6 bzw. 8 Zähne
- Frese multi-taglienti lunghe SE 60, 6 - 8 taglienti
- Fraises Multidentés SE 60 longues, 6 - 8 dents
- 整体硬质合金 SE 60 系列 6-8刃长型多刃平底铣刀

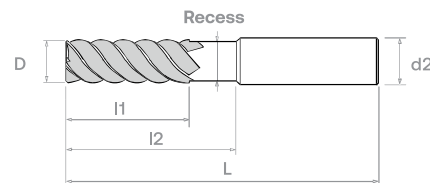

Order Number	Dimension (mm)						B0909	Order Number	Dimension (mm)						B0909
	D	l1	l2	L	d2 (h6)	Z			D	l1	l2	L	d2 (h6)	Z	
A44 0300 075 06	3	19		75	6	6	•	A45 0300 075 06	3	19	30	75	6	6	•
A44 0400 075 06	4			75	6	6	•	A45 0400 075 06	4		32	75	6	6	•
A44 0500 075 06	5			75	6	6	•	A45 0500 075 06	5		32	75	6	6	•
A44 0600	6	31		75	6	6	•	A45 0600	6	31	40	75	6	6	•
A44 0800	8			75	8	6	•	A45 0800	8		40	75	8	6	•
A44 1000	10	45		100	10	6	•	A45 1000	10	45	60	100	10	6	•
A44 1200	12	50		100	12	6	•	A45 1200	12	50	60	100	12	6	•
A44 1400	14	57		125	14	6	•	A45 1400	14	57	85	125	14	6	•
A44 1600	16			125	16	8	•	A45 1600	16		85	125	16	8	•
A44 1800	18			125	18	8	•	A45 1800	18		85	125	18	8	•
A44 2000	20			125	20	8	•	A45 2000	20		85	125	20	8	•

Material Group | Material-Gruppe | Groupe Matière | Gruppo Materiali | 材质主类

Cutting Parameter

N01	N02	N03	K01	K02	P01	P02	P03	M01	M02	S01	S02	S03	H01	H02	O01	O02	266
-----	-----	-----	-----	-----	-----	-----	-----	-----	-----	-----	-----	-----	-----	-----	-----	-----	-----

SE 60 EXTRA-LONG MULTIFLUTE ENDMILLS / WITH RECESS, 6 - 8 FLUTES

- VHM SE 60 Mehrzahnfräser, extra-lang, 6 bzw. 8 Zähne
- Frese multi-taglienti extra-lunghe SE 60, 6 - 8 taglienti
- Fraises Multidentés SE 60 extra-longues, 6 - 8 dents
- 整体硬质合金 SE 60 系列 6-8刃加长型多刃平底铣刀

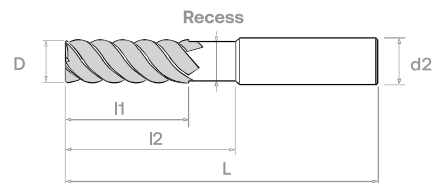
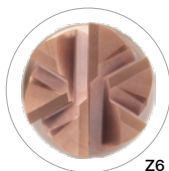

Order Number	Dimension (mm)						B0909	Order Number	Dimension (mm)						B0909	
	D	l1	l2	L	d2 (h6)	Z			D	l1	l2	L	d2 (h6)	Z		
A46 0300 100 06	3	25		100	6	6	•	A47 0300 100 06	3	25	60	100	6	6	•	
A46 0400 100 06	4	31		100	6	6	•	A47 0400 100 06	4	31	60	100	6	6	•	
A46 0500 100 06	5			100	6	6	•	A47 0500 100 06	5			60	100	6	6	•
A46 0600	6	38		100	6	6	•	A47 0600	6	38	60	100	6	6	•	
A46 0800	8	41		100	8	6	•	A47 0800	8	41	60	100	8	6	•	
A46 1000	10	57		125	10	6	•	A47 1000	10	57	85	125	10	6	•	
A46 1200	12	75		150	12	6	•	A47 1200	12	75	110	150	12	6	•	
A46 1400	14			150	14	6	•	A47 1400	14			110	150	14	6	•
A46 1600	16			150	16	8	•	A47 1600	16			110	150	16	8	•
A46 1800	18			150	18	8	•	A47 1800	18			110	150	18	8	•
A46 2000	20			150	20	8	•	A47 2000	20			110	150	20	8	•

- ALU LINE
- EZ LINE - ENDMILL
- SE 30
- NITICO 30
- OPTIMUM
- SE 45
- SE 45X
- NITICO 45
- SE 60
- SE 60X
- DM70 - SE70
- SE GR
- TE 45
- PLUNGE -MILL
- THREAD MILL

Material Group | Material-Gruppe | Groupe Matière | Gruppo Materiali | 材质主类

Cutting Parameter

N01	N02	N03	K01	K02	P01	P02	P03	M01	M02	S01	S02	S03	H01	H02	O01	O02
-----	-----	-----	-----	-----	-----	-----	-----	-----	-----	-----	-----	-----	-----	-----	-----	-----

267

SE 60 SHORT FLUTES ENDMILLS, 4 FLUTES

- VHM SE 60 Fräser, 4 Zähne
- Frese SE 60, con taglienti corti, 4 taglienti
- Fraises SE 60, 4 dents
- 整体硬质合金 SE 60 系列 4刃平底铣刀

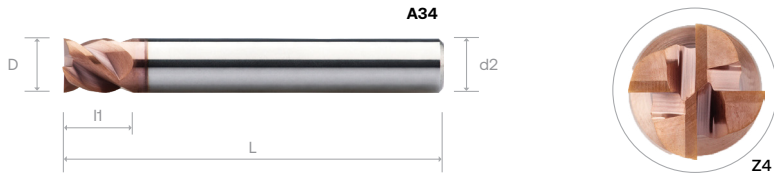

Order Number	Dimension (mm)					B0909
	D	I1	I2	L	d2 (h6)	
A34 0300 060 06	3	4		60	6	•
A34 0400 060 06	4	5		60	6	•
A34 0500 060 06	5	6		60	6	•
A34 0600	6	7		60	6	•
A34 0800	8	9		64	8	•
A34 1000	10	11		70	10	•
A34 1200	12	13		75	12	•
A34 1600	16	17		90	16	•

ALU LINE
 EZ LINE - ENDMILL
 SE 30
 NITCo 30
 OPTIMUM
 SE 45
 SE 45X
 NITCo 45
SE 60
 SE 60X
 DM70 - SE70
 SE GR
 TE 45
 PLUNGE -MILL
 THREAD MILL

Material Group | Material-Gruppe | Groupe Matière | Gruppo Materiali | 材质主类

Cutting Parameter

N01	N02	N03	K01	K02	P01	P02	P03	M01	M02	S01	S02	S03	H01	H02	O01	O02	265
-----	-----	-----	-----	-----	-----	-----	-----	-----	-----	-----	-----	-----	-----	-----	-----	-----	-----

SE 60R TORUS ENDMILLS, SHORT FLUTES / WITH RECESS, 4 FLUTES

- VHM SE 60R Standard Torusfräser, kurzen Nuten, 4 Zähne
- Frese toroidali SE 60R, con taglienti corti, 4 taglienti
- Fraises toriques SE 60R, dents courtes, 4 dents
- 整体硬质合金 SE 60R 系列 4刃短刃圆鼻铣刀

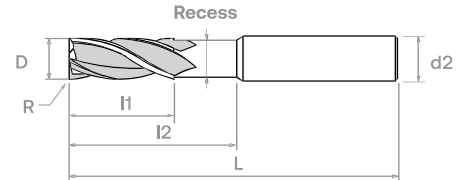
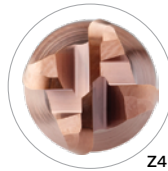

Order Number	Dimension (mm)						B0909	Order Number	Dimension (mm)						B0909
	D	l1	l2	L	d2 (h6)	R			D	l1	l2	L	d2 (h6)	R	
A48 0300 060 0600 030	3	4		60	6	0.3	•	A49 0300 060 0600 030	3	4	14	60	6	0.3	•
A48 0300 060 0600 050				60	6	0.5	•	A49 0300 060 0600 050			14	60	6	0.5	•
A48 0400 060 0600 030	4	5		60	6	0.3	•	A49 0400 060 0600 030	4	5	16	60	6	0.3	•
A48 0400 060 0600 050				60	6	0.5	•	A49 0400 060 0600 050			16	60	6	0.5	•
A48 0500 060 0600 030	5	6		60	6	0.3	•	A49 0500 060 0600 030	5	6	18	60	6	0.3	•
A48 0500 060 0600 050				60	6	0.5	•	A49 0500 060 0600 050			18	60	6	0.5	•
A48 0600 060 0600 030	6	7		60	6	0.3	•	A49 0600 060 0600 030	6	7	20	60	6	0.3	•
A48 0600 060 0600 050				60	6	0.5	•	A49 0600 060 0600 050			20	60	6	0.5	•
A48 0600 060 0600 100				60	6	1.0	•	A49 0600 060 0600 100			20	60	6	1.0	•
A48 0800 064 0800 030	8	9		64	8	0.3	•	A49 0800 064 0800 030 *	8	9	26	64	8	0.3	•
A48 0800 064 0800 050				64	8	0.5	•	A49 0800 064 0800 050 *			26	64	8	0.5	•
A48 0800 064 0800 100				64	8	1.0	•	A49 0800 064 0800 100 *			26	64	8	1.0	•
A48 1000 070 1000 050	10	11		70	10	0.5	•	A49 1000 070 1000 050	10	11	31	70	10	0.5	•
A48 1000 070 1000 100				70	10	1.0	•	A49 1000 070 1000 100			31	70	10	1.0	•
A48 1000 070 1000 200				70	10	2.0	•	A49 1000 070 1000 200			31	70	10	2.0	•
A48 1200 075 1200 050	12	13		75	12	0.5	•	A49 1200 075 1200 050	12	13	37	75	12	0.5	•
A48 1200 075 1200 100				75	12	1.0	•	A49 1200 075 1200 100			37	75	12	1.0	•
A48 1200 075 1200 200				75	12	2.0	•	A49 1200 075 1200 200			37	75	12	2.0	•
A48 1600 090 1600 050	16	17		90	16	0.5	•	A49 1600 090 1600 050	16	17	43	90	16	0.5	•
A48 1600 090 1600 100				90	16	1.0	•	A49 1600 090 1600 100			43	90	16	1.0	•
A48 1600 090 1600 200				90	16	2.0	•	A49 1600 090 1600 200			43	90	16	2.0	•
A48 1600 090 1600 300				90	16	3.0	•	A49 1600 090 1600 300			43	90	16	3.0	•

* - DIN 6535

Material Group | Material-Gruppe | Groupe Matière | Gruppo Materiali | 材质主类

Cutting Parameter

N01	N02	N03	K01	K02	P01	P02	P03	M01	M02	S01	S02	S03	H01	H02	O01	O02	265
-----	-----	-----	-----	-----	-----	-----	-----	-----	-----	-----	-----	-----	-----	-----	-----	-----	-----

SE 60R LONG REACH TORUS ENDMILLS, SHORT FLUTES - LONG / WITH RECESS, 4 FLUTES

- VHM SE 60R LONG REACH Fräser, lang, mit kurzen Nuten, 4 Zähne
- Frese torodali lunghe SE 60R LONG REACH, con taglienti corti, 4 taglienti
- Fraises SE 60R LONG REACH toriques longues, dents courtes, 4 dents
- 整体硬质合金 SE 60R 系列 4刃长型长颈短刃圆鼻铣刀

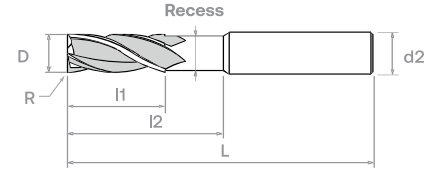
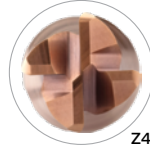

Order Number	Dimension (mm)						B0909	Order Number	Dimension (mm)						B0909	
	D	l1	l2	L	d2 (H6)	R			D	l1	l2	L	d2 (H6)	R		
A51 0200 075 0600 020	2	4		75	6	0.2	•	A52 0200 075 0600 020 *	2	4	30	75	6	0.2	•	
A51 0200 075 0600 030				75	6	0.3	•	A52 0200 075 0600 030 *				30	75	6	0.3	•
A51 0300 075 0600 020				75	6	0.2	•	A52 0300 075 0600 020				30	75	6	0.2	•
A51 0300 075 0600 030	3	5		75	6	0.3	•	A52 0300 075 0600 030	3	5	30	75	6	0.3	•	
A51 0300 075 0600 050				75	6	0.5	•	A52 0300 075 0600 050				30	75	6	0.5	•
A51 0400 075 0600 020				75	6	0.2	•	A52 0400 075 0600 020				32	75	6	0.2	•
A51 0400 075 0600 030	4	8		75	6	0.3	•	A52 0400 075 0600 030	4	8	32	75	6	0.3	•	
A51 0400 075 0600 050				75	6	0.5	•	A52 0400 075 0600 050				32	75	6	0.5	•
A51 0500 075 0600 020				75	6	0.2	•	A52 0500 075 0600 020				32	75	6	0.2	•
A51 0500 075 0600 030	5	9		75	6	0.3	•	A52 0500 075 0600 030	5	9	32	75	6	0.3	•	
A51 0500 075 0600 050				75	6	0.5	•	A52 0500 075 0600 050				32	75	6	0.5	•
A51 0600 075 0600 020				75	6	0.2	•	A52 0600 075 0600 020				40	75	6	0.2	•
A51 0600 075 0600 030	6	10		75	6	0.3	•	A52 0600 075 0600 030	6	10	40	75	6	0.3	•	
A51 0600 075 0600 050				75	6	0.5	•	A52 0600 075 0600 050				40	75	6	0.5	•
A51 0600 075 0600 100				75	6	1	•	A52 0600 075 0600 100				40	75	6	1	•
A51 0800 075 0800 020	8	12		75	8	0.2	•	A52 0800 075 0800 020	8	12	40	75	8	0.2	•	
A51 0800 075 0800 030				75	8	0.3	•	A52 0800 075 0800 030				40	75	8	0.3	•
A51 0800 075 0800 050				75	8	0.5	•	A52 0800 075 0800 050				40	75	8	0.5	•
A51 0800 075 0800 100		75	8	1	•	A52 0800 075 0800 100		40	75	8	1	•				
A51 1000 075 1000 020	10	14		75	10	0.2	•	A52 1000 075 1000 020	10	14	40	75	10	0.2	•	
A51 1000 075 1000 030				75	10	0.3	•	A52 1000 075 1000 030				40	75	10	0.3	•
A51 1000 075 1000 050				75	10	0.5	•	A52 1000 075 1000 050				40	75	10	0.5	•
A51 1000 075 1000 100		75	10	1	•	A52 1000 075 1000 100		40	75	10	1	•				
A51 1000 075 1000 200		75	10	2	•	A52 1000 075 1000 200		40	75	10	2	•				
A51 1000 100 1000 020	10	14		100	10	0.2	•	A52 1000 100 1000 020 *	10	14	60	100	10	0.2	•	
A51 1000 100 1000 030				100	10	0.3	•	A52 1000 100 1000 030 *				60	100	10	0.3	•
A51 1000 100 1000 050				100	10	0.5	•	A52 1000 100 1000 050 *				60	100	10	0.5	•
A51 1000 100 1000 100		100	10	1	•	A52 1000 100 1000 100 *		60	100	10	1	•				
A51 1000 100 1000 200		100	10	2	•	A52 1000 100 1000 200 *		60	100	10	2	•				
A51 1200 100 1200 020	12	16		100	12	0.2	•	A52 1200 100 1200 020	12	16	60	100	12	0.2	•	
A51 1200 100 1200 030				100	12	0.3	•	A52 1200 100 1200 030				60	100	12	0.3	•
A51 1200 100 1200 050				100	12	0.5	•	A52 1200 100 1200 050				60	100	12	0.5	•
A51 1200 100 1200 100		100	12	1	•	A52 1200 100 1200 100		60	100	12	1	•				
A51 1200 100 1200 200		100	12	2	•	A52 1200 100 1200 200		60	100	12	2	•				
A51 1600 125 1600 030	16	22		125	16	0.3	•	A52 1600 125 1600 030	16	22	85	125	16	0.3	•	
A51 1600 125 1600 050				125	16	0.5	•	A52 1600 125 1600 050				85	125	16	0.5	•
A51 1600 125 1600 100				125	16	1	•	A52 1600 125 1600 100				85	125	16	1	•
A51 1600 125 1600 200		125	16	2	•	A52 1600 125 1600 200		85	125	16	2	•				
A51 1600 125 1600 300		125	16	3	•	A52 1600 125 1600 300		85	125	16	3	•				

* - DIN 6535

Material Group | Material-Gruppe | Groupe Matière | Gruppo Materiali | 材质主类

Cutting Parameter

N01	N02	N03	K01	K02	P01	P02	P03	M01	M02	S01	S02	S03	H01	H02	O01	O02	265
-----	-----	-----	-----	-----	-----	-----	-----	-----	-----	-----	-----	-----	-----	-----	-----	-----	-----

SE 60R TORUS SHORT FLUTES LONG REACH ENDMILLS - EXTRA-LONG / WITH RECESS, 4 FLUTES

- VHM SE 60R LONG REACH Fräser, extra-lang, mit kurzen Nuten, 4 Zähne
- Frese torodali extra-lunghe SE 60R long-reach, con taglienti corti, 4 taglienti
- Fraises toriques SE 60R LONG REACH extra-longues, dents courtes, 4 dents
- 整体硬质合金 SE 60R 系列 4刃加长型长颈短刃圆鼻铣刀

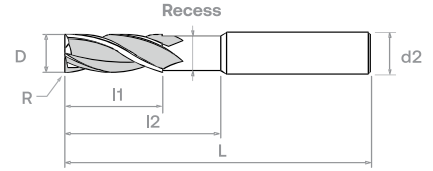
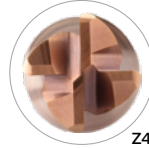

Order Number	Dimension (mm)						B0909	Order Number	Dimension (mm)						B0909	
	D	I1	I2	L	d2 (h6)	R			D	I1	I2	L	d2 (h6)	R		
A53 0200 100 0600 020	2	4		100	6	0.2	•	A54 0200 100 0600 020	2	4	60	100	6	0.2	•	
A53 0200 100 0600 030				100	6	0.3	•	A54 0200 100 0600 030				60	100	6	0.3	•
A53 0300 100 0600 020	3	5		100	6	0.2	•	A54 0300 100 0600 020	3	5	60	100	6	0.2	•	
A53 0300 100 0600 030				100	6	0.3	•	A54 0300 100 0600 030				60	100	6	0.3	•
A53 0300 100 0600 050				100	6	0.5	•	A54 0300 100 0600 050				60	100	6	0.5	•
A53 0300 100 0600 100	4	8		100	6	1	•	A54 0300 100 0600 100	4	8	60	100	6	1	•	
A53 0400 100 0600 020				100	6	0.2	•	A54 0400 100 0600 020 *				60	100	6	0.2	•
A53 0400 100 0600 030				100	6	0.3	•	A54 0400 100 0600 030 *				60	100	6	0.3	•
A53 0400 100 0600 050				100	6	0.5	•	A54 0400 100 0600 050 *				60	100	6	0.5	•
A53 0400 100 0600 100	5	9		100	6	1	•	A54 0400 100 0600 100 *	5	9	60	100	6	1	•	
A53 0500 100 0600 020				100	6	0.2	•	A54 0500 100 0600 020				60	100	6	0.2	•
A53 0500 100 0600 030				100	6	0.3	•	A54 0500 100 0600 030				60	100	6	0.3	•
A53 0500 100 0600 050				100	6	0.5	•	A54 0500 100 0600 050				60	100	6	0.5	•
A53 0500 100 0600 100				100	6	1	•	A54 0500 100 0600 100				60	100	6	1	•
A53 0600 100 0600 020	6	10		100	6	0.2	•	A54 0600 100 0600 020	6	10	60	100	6	0.2	•	
A53 0600 100 0600 030				100	6	0.3	•	A54 0600 100 0600 030				60	100	6	0.3	•
A53 0600 100 0600 050				100	6	0.5	•	A54 0600 100 0600 050				60	100	6	0.5	•
A53 0600 125 0600 020				125	6	0.2	•	A54 0600 125 0600 020				60	125	6	0.2	•
A53 0600 125 0600 030				125	6	0.3	•	A54 0600 125 0600 030				60	125	6	0.3	•
A53 0600 125 0600 050				125	6	0.5	•	A54 0600 125 0600 050				60	125	6	0.5	•
A53 0600 125 0600 100	8	12		125	6	1	•	A54 0600 125 0600 100	8	12	60	125	6	1	•	
A53 0800 100 0800 020				100	8	0.2	•	A54 0800 100 0800 020				60	100	8	0.2	•
A53 0800 100 0800 030				100	8	0.3	•	A54 0800 100 0800 030				60	100	8	0.3	•
A53 0800 100 0800 050				100	8	0.5	•	A54 0800 100 0800 050				60	100	8	0.5	•
A53 0800 100 0800 100				100	8	1	•	A54 0800 100 0800 100				60	100	8	1	•
A53 0800 100 0800 200				100	8	2	•	A54 0800 100 0800 200				60	100	8	2	•
A53 0800 125 0800 020				125	8	0.2	•	A54 0800 125 0800 020				60	125	8	0.2	•
A53 0800 125 0800 030		125	8	0.3	•	A54 0800 125 0800 030		60	125	8	0.3	•				
A53 0800 125 0800 050		125	8	0.5	•	A54 0800 125 0800 050		60	125	8	0.5	•				
A53 0800 125 0800 100	10	14		125	8	1	•	A54 0800 125 0800 100	10	14	60	125	8	1	•	
A53 0800 125 0800 200				125	8	2	•	A54 0800 125 0800 200				60	125	8	2	•
A53 1000 125 1000 020				125	10	0.2	•	A54 1000 125 1000 020 *				85	125	10	0.2	•
A53 1000 125 1000 030				125	10	0.3	•	A54 1000 125 1000 030 *				85	125	10	0.3	•
A53 1000 125 1000 050				125	10	0.5	•	A54 1000 125 1000 050 *				85	125	10	0.5	•
A53 1000 125 1000 100				125	10	1	•	A54 1000 125 1000 100 *				85	125	10	1	•
A53 1000 125 1000 200				125	10	2	•	A54 1000 125 1000 200 *				85	125	10	2	•
A53 1000 150 1000 020				150	10	0.2	•	A54 1000 150 1000 020				85	150	10	0.2	•
A53 1000 150 1000 030	12	16		150	10	0.3	•	A54 1000 150 1000 030	12	16	85	150	10	0.3	•	
A53 1000 150 1000 050				150	10	0.5	•	A54 1000 150 1000 050				85	150	10	0.5	•
A53 1000 150 1000 100				150	10	1	•	A54 1000 150 1000 100				85	150	10	1	•
A53 1000 150 1000 200		150	10	2	•	A54 1000 150 1000 200		85	150	10	2	•				
A53 1200 150 1200 020		150	12	0.2	•	A54 1200 150 1200 020	16	22	110	150	12	0.2	•			
A53 1200 150 1200 030		150	12	0.3	•	A54 1200 150 1200 030				110	150	12	0.3	•		
A53 1200 150 1200 050		150	12	0.5	•	A54 1200 150 1200 050				110	150	12	0.5	•		
A53 1200 150 1200 100		150	12	1	•	A54 1200 150 1200 100		110	150	12	1	•				
A53 1200 150 1200 200		150	12	2	•	A54 1200 150 1200 200		110	150	12	2	•				
A53 1600 150 1600 030	16	22		150	16	0.3	•	A54 1600 150 1600 030	16	22	110	150	16	0.3	•	
A53 1600 150 1600 050				150	16	0.5	•	A54 1600 150 1600 050				110	150	16	0.5	•
A53 1600 150 1600 100				150	16	1	•	A54 1600 150 1600 100				110	150	16	1	•
A53 1600 150 1600 200				150	16	2	•	A54 1600 150 1600 200				110	150	16	2	•
A53 1600 150 1600 300		150	16	3	•	A54 1600 150 1600 300		110	150	16	3	•				

* - DIN 6535

Material Group | Material-Gruppe | Groupe Matière | Gruppo Materiali | 材质主类

N01	N02	N03	K01	K02	P01	P02	P03	M01	M02	S01	S02	S03	H01	H02	O01	O02
-----	-----	-----	-----	-----	-----	-----	-----	-----	-----	-----	-----	-----	-----	-----	-----	-----

Cutting Parameter

266

ALL LINE
EZ LINE -
ENDMILL
SE 30
NITICO 30
OPTIMUM
SE 45
SE 45X
NITICO 45
SE 60
SE 60X
DN70 -
SE70
SE GR
TE 45
PLUNGE
-MILL
THREAD
MILL

SE 60 MINIATURE ENDMILLS, 2 FLUTES

- VHM SE 60 Kleinstfräser, 2 Zähne
- Micro-frese SE 60, 2 taglienti
- Micro-Fraises SE 60, 2 dents
- 整体硬质合金 SE 60 系列 微小径2刀平底铣刀

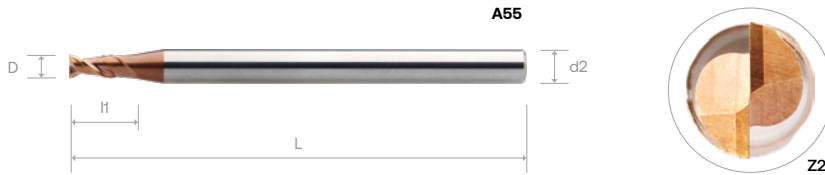
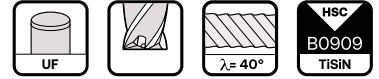

Order Number	Dimension (mm)					B0909
	D	I1	I2	L	d2 (h6)	
A55 0010 03	0.1	0.2		40	3	•
A55 0010 04				40	4	•
A55 0020 03	0.2	0.4		40	3	•
A55 0020 04				40	4	•
A55 0030 03	0.3	0.6		40	3	•
A55 0030 04				40	4	•
A55 0040 03	0.4	0.8		40	3	•
A55 0040 04				40	4	•
A55 0050 03	0.5	1.0		40	3	•
A55 0050 04				40	4	•
A55 0060 03	0.6	1.2		40	3	•
A55 0060 04				40	4	•
A55 0070 03	0.7	1.4		40	3	•
A55 0070 04				40	4	•
A55 0080 03	0.8	1.6		40	3	•
A55 0080 04				40	4	•
A55 0090 03	0.9	1.8		40	3	•
A55 0090 04				40	4	•

D mm	Tol. μm
0.1 - 0.7	0 / -12
0.7 - 4.0	0 / -20

Material Group | Material-Gruppe | Groupe Matière | Gruppo Materiali | 材质主类

Cutting Parameter

N01	N02	N03	K01	K02	P01	P02	P03	M01	M02	S01	S02	S03	H01	H02	O01	O02	267
-----	-----	-----	-----	-----	-----	-----	-----	-----	-----	-----	-----	-----	-----	-----	-----	-----	-----

Note: These recommended cutting data indicators are just for reference. They should be adjusted according to the different cutting condition



SE 60 Long Endmills, 4 Flutes - A36

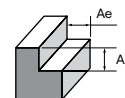

Side Milling	H				
Working Material	Hardened steel		Hardened steel		
Properties	45 ≤ HRC < 52		52 ≤ HRC < 68		
Cutting depth, ap	1.50 × D		1.50 × D		
Cutting Width, ae	0.12 × D		0.08 × D		
D	Vc	Fz	Vc	Fz	
3	90	0.014	60	0.010	
4		0.020		0.013	
5		0.024		0.017	
6		0.030		0.020	
8		0.041		0.028	
10		0.052		0.035	
12		0.063		0.044	
14		0.072		0.050	
16		0.082		0.057	
18		0.091		0.061	
20		0.101		0.068	
20		0.101		0.101	0.068

SE 60 Extra-Long Endmills, 4 Flutes - A37

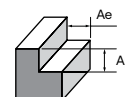

Side Milling	H			
Working Material	Hardened steel		Hardened steel	
Properties	45 ≤ HRC < 52		52 ≤ HRC < 68	
Cutting depth, ap	2.00 × D		2.00 × D	
Cutting Width, ae	0.08 × D		0.05 × D	
D	Vc	Fz	Vc	Fz
3	80	0.015	50	0.008
4		0.020		0.011
5		0.026		0.014
6		0.031		0.018
8		0.042		0.024
10		0.053		0.031
12		0.065		0.039
14		0.074		0.044
16		0.085		0.051
18		0.094		0.054
20		0.104		0.059

ALU LINE
 EZ LINE -
 ENDMILL
 SE 30
 NITCO 30
 OPTIMUM
 SE 45
 SE 45X
 NITCO 45
SE 60
 SE 60X
 DN70 -
 SE 70
 SE GR
 TE 45
 PLUNGE
 -MILL
 THREAD
 MILL

Note: These recommended cutting data indicators are just for reference. They should be adjusted according to the different cutting condition

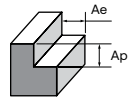

SE 60 Short Flutes Endmills, 4 Flutes - A34, A48, A49

Side Milling		H			
Working Material		Hardened steel		Hardened steel	
Properties		45 ≤ HRC < 52		52 ≤ HRC < 68	
Cutting depth, ap		0.30 × D		0.25 × D	
Cutting Width, ae		0.40 × D		0.40 × D	
D	Vc	Fz	Vc	Fz	
3	100	0.016	70	0.011	
4		0.021		0.014	
5		0.027		0.018	
6		0.032		0.022	
8		0.043		0.029	
10		0.054		0.038	
12		0.066		0.047	
14		0.076		0.053	
16		0.085		0.061	

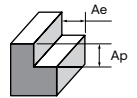

SE 60 Short Flutes Long Reach Long Endmills, 4 Flutes - A38, A39, A51, A52

Side Milling		H			
Working Material		Hardened steel		Hardened steel	
Properties		45 ≤ HRC < 52		52 ≤ HRC < 68	
Cutting depth, ap		0.25 × D		0.20 × D	
Cutting Width, ae		0.35 × D		0.35 × D	
D	Vc	Fz	Vc	Fz	
2	90	0.009	60	0.006	
3		0.014		0.010	
4		0.020		0.013	
5		0.024		0.017	
6		0.030		0.020	
8		0.041		0.028	
10		0.052		0.035	
12		0.063		0.044	
14		0.072		0.050	
16		0.082		0.057	
18	0.091	0.061			
20	0.101	0.068			

ALU LINE
EZ LINE - ENDMILL
SE 30
SE 30
NITCo 30
OPTIMUM
SE 45
SE 45X
NITCo 45
SE 60
SE 60X
DM70 - SE70
SE GR
TE 45
PLUNGE -MILL
THREAD MILL

Note: These recommended cutting data indicators are just for reference. They should be adjusted according to the different cutting condition



SE 60 Short Flutes Long Reach Extra-Long Endmills, 4 Flutes - A40, A41, A53, A54

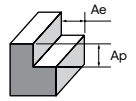

Side Milling	H			
Working Material	Hardened steel		Hardened steel	
Properties	45 ≤ HRC < 52		52 ≤ HRC < 68	
Cutting depth, ap	0.23 × D		0.18 × D	
Cutting Width, ae	0.32 × D		0.32 × D	
D	Vc	Fz	Vc	Fz
2	80	0.010	50	0.005
3		0.015		0.008
4		0.020		0.011
5		0.026		0.014
6		0.031		0.018
8		0.042		0.024
10		0.053		0.031
12		0.065		0.039
14		0.074		0.044
16		0.085		0.051
18		0.094		0.054
20		0.104		0.059

SE 60 MultiFlutes Long Endmills, 6 Flutes - A44, A45

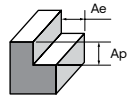

Side Milling	H			
Working Material	Hardened steel		Hardened steel	
Properties	45 ≤ HRC < 52		52 ≤ HRC < 68	
Cutting depth, ap	1.50 × D		1.50 × D	
Cutting Width, ae	0.06 × D		0.05 × D	
D	Vc	Fz	Vc	Fz
3	95	0.011	65	0.008
4		0.016		0.011
5		0.020		0.014
6		0.024		0.017
8		0.033		0.023
10		0.041		0.030
12		0.049		0.038
14		0.057		0.043

SE 60 MultiFlutes Long Endmills, 8 Flutes - A44, A45

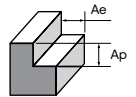

Side Milling	H			
Working Material	Hardened steel		Hardened steel	
Properties	45 ≤ HRC < 52		52 ≤ HRC < 68	
Cutting depth, ap	1.50 × D		1.50 × D	
Cutting Width, ae	0.06 × D		0.05 × D	
D	Vc	Fz	Vc	Fz
16	95	0.062	65	0.047
18		0.069		0.052
20		0.076		0.057

AU LINE
EZ LINE -
ENDMILL
SE 30
NITCO 30
OPTIMUM
SE 45
SE 45X
NITCO 45
SE 60
SE 60X
DN70 -
SE 70
SE GR
TE 45
PLUNGE
-MILL
THREAD
MILL

Note: These recommended cutting data indicators are just for reference. They should be adjusted according to the different cutting condition



ALU LINE
EZ LINE - ENDMILL
SE 30
NITCo 30
OPTIMUM
SE 45
SE 45X
NITCo 45
SE 60
SE 60X
DM70 - SE70
SE GR
TE 45
PLUNGE -MILL
THREAD MILL

SE 60 MultiFlutes Extra-Long Endmills, 6 Flutes - A46, A47

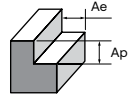

Side Milling		H			
Working Material	Hardened steel		Hardened steel		
Properties	45 ≤ HRC < 52		52 ≤ HRC < 68		
Cutting depth, ap	2.00 × D		2.00 × D		
Cutting Width, ae	0.04 × D		0.03 × D		
D	Vc	Fz	Vc	Fz	
3	80	0.010	50	0.007	
4		0.014		0.010	
5		0.018		0.013	
6		0.022		0.016	
8		0.030		0.022	
10		0.038		0.028	
12		0.047		0.036	
14		0.054		0.041	

SE 60 MultiFlutes Extra-Long Endmills, 8 Flutes - A46, A47

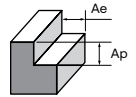

Side Milling		H			
Working Material	Hardened steel		Hardened steel		
Properties	45 ≤ HRC < 52		52 ≤ HRC < 68		
Cutting depth, ap	2.00 × D		2.00 × D		
Cutting Width, ae	0.04 × D		0.03 × D		
D	Vc	Fz	Vc	Fz	
16	80	0.060	50	0.045	
18		0.066		0.050	
20		0.072		0.053	

SE 60 Miniature Endmills, 2 Flutes - A55

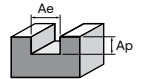

Slotting		H				
Working Material	Hardened steel			Hardened steel		
Properties	45 ≤ HRC < 52			52 ≤ HRC < 68		
D	Ap	N	Fz	Ap	N	Fz
0.1	0.020	50000	0.002	0.020	50000	0.002
0.2	0.040	50000	0.003	0.020	50000	0.002
0.3	0.060	50000	0.003	0.030	50000	0.002
0.4	0.080	50000	0.003	0.040	40000	0.003
0.5	0.100	50000	0.003	0.050	32000	0.003
0.6	0.120	48000	0.004	0.060	26500	0.005
0.7	0.140	41100	0.005	0.070	22700	0.006
0.8	0.160	35700	0.006	0.080	20000	0.007
0.9	0.180	32000	0.007	0.090	17800	0.008



ENDMILLS

SE 60X









Suitable for high speed milling

For material application between 40 HRC to 60 HRC

Index - SE 60X, For 40 - 60 HRC

Suitable for Material Groups
 Adapté pour les matériaux
 适用于材料
 Geeignet für die Materialgruppen
 Adatto per il materiale

P **H**

EDP Number	Type	No. Z	Helix Angle	Coating	Performance	Page Number
G78 	SE 60X Fin-Mill Torus	4/6	25°	B0909	P	272
G80 	SE 60X Fin-Mill Torus, Recess	4/6	25°	B0909	P	272
G82 	SE 60X Fin-Mill Torus Long	4/6	25°	B0909	P	273
G84 	SE 60X Fin-Mill Torus Long, Recess	4/6	25°	B0909	P	273
A4G 	SE 60X Fin-Mill Torus Miniature Long Neck	2/4	25°	B0909	P	274
A4F 	SE 60X Fin-Mill Taper Neck	4	25°	B0909	P	278
815 	SE 60X	4	25°	G6110	P	280
A98 	SE 60X, Recess	4	25°	B0909	P	280
G86 	SE 60X Sweep-Mill	4/6	3°	B0909	P	283

G - General P - Performance

FEATURES & BENEFITS

SE 60X Fin-Mill



Top View

1 4/6 Flutes

2x to 3x feed rate in comparison with conventional 2 flutes cutter

2 Tough PVD Silicon Based Coating

- Prolong the tool life
- Enables higher cutting speeds
- Increases hardness and higher abrasive wear resistance
- Smoother chips evacuation



3 Suitable for Material Groups





1. 4/6 Schneiden
zwei- bzw. dreifacher Vorschub gegenüber Fräsen
mit 2 Schneiden
2. PVD-Silizium-Hartbeschichtung
verlängert die Lebensdauer des Werkzeugs
ermöglicht höhere Schnittgeschwindigkeiten
erhöht die Hitzebeständigkeit, deshalb sehr gut
geeignet für Trockenbearbeitung
3. Geeignet für Materialgruppe P, H



1. 4/6 刃
与常规的 2 刃刀具相比, 进给速率提高 2 倍或 3 倍。
2. 耐用的 PVD 硅基涂层
延长刀具寿命。
实现更高的切屑速度。
增加耐热性, 因此非常适合干式切削。
3. 适用高硬度材料 P、H



1. 4/6 scanalature
velocità di avanzamento 2 o 3 volte maggiore rispetto
a cutter tradizionali a 2 scanalature
2. Rivestimento in silicene PVD resistente
prolunga la vita dello strumento
consente maggiori velocità di taglio
aumenta la resistenza al calore ed è quindi adatto per
la lavorazione a secco
3. Adatto per Materiale P, H



1. 4/6 goujures
Débit 2 à 3 fois plus élevé que les dispositifs de coupe
conventionnels à 2 goujures
2. Revêtement à base de silicium sous forme de dépôt
en phase vapeur résistant
prolonge la durée de vie de l'outil
permet des vitesses de coupe supérieures
augmente la résistance à la chaleur, donc parfaitement
adapté à l'usinage à sec
3. Adapté au matériaux P, H

SE 60X FIN-MILL TORUS ENDMILLS / WITH RECESS, 4 - 6 FLUTES

- VHM SE 60X Fin-mill Standard Torusfräser, 4 / 6 Zähne
- Frese ad alto avanzamento toroidali SE 60X, 4 - 6 taglienti
- Fraises 2 tailles SE 60X Fin-mill toriques - Standard, 4 - 6 dents
- 整体硬质合金 SE60X Fin-mill 系列 4/6刃圆鼻铣刀

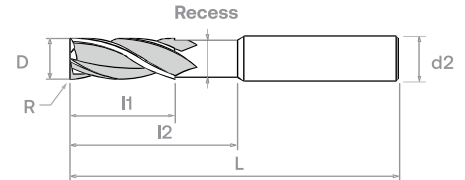
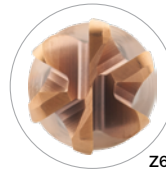
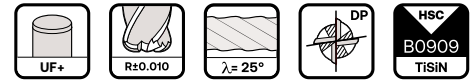

Order Number	Dimension (mm)								B0909	Order Number	Dimension (mm)								B0909
	D	I1	I2	L	d2 (h6)	R	Z	D			I1	I2	L	d2 (h6)	R	Z			
G78 0200 060 0600 030	2	2		60	6	0.3	4	•	G80 0200 060 0600 030	2	2	10	60	6	0.3	4	•		
G78 0200 060 0600 050				60	6	0.5	4	•	G80 0200 060 0600 050				20	60	6	0.5	4	◦	
G78 0300 060 0600 030	3	3		60	6	0.3	4	•	G80 0300 060 0600 030	3	3	21	60	6	0.3	4	◦		
G78 0300 060 0600 050				60	6	0.5	4	•	G80 0300 060 0600 050				21	60	6	0.5	4	•	
G78 0400 060 0600 030	4	4		60	6	0.3	4	◦	G80 0400 060 0600 030	4	4	12	60	6	0.3	4	◦		
G78 0400 060 0600 050				60	6	0.5	4	◦	G80 0400 060 0600 050				12	60	6	0.5	4	•	
G78 0600 060 0600 030	6	6		60	6	0.3	4	•	G80 0600 060 0600 030	6	6	20	60	6	0.3	4	•		
G78 0600 060 0600 050				60	6	0.5	4	◦	G80 0600 060 0600 050				20	60	6	0.5	4	•	
G78 0600 060 0600 100				60	6	1	4	•	G80 0600 060 0600 100				20	60	6	1	4	•	
G78 0800 064 0800 030	8	8		64	8	0.3	6	•	G80 0800 064 0800 030	8	8	24	64	8	0.3	6	◦		
G78 0800 064 0800 050				64	8	0.5	6	•	G80 0800 064 0800 050				24	64	8	0.5	6	◦	
G78 0800 064 0800 100				64	8	1	6	◦	G80 0800 064 0800 100				24	64	8	1	6	•	
G78 0800 064 0800 200				64	8	2	6	•	G80 0800 064 0800 200				24	64	8	2	6	◦	
G78 1000 075 1000 030	10	10		75	10	0.3	6	•	G80 1000 075 1000 030	10	10	30	75	10	0.3	6	◦		
G78 1000 075 1000 050				75	10	0.5	6	•	G80 1000 075 1000 050				30	75	10	0.5	6	◦	
G78 1000 075 1000 100				75	10	1	6	◦	G80 1000 075 1000 100				30	75	10	1	6	•	
G78 1000 075 1000 200				75	10	2	6	•	G80 1000 075 1000 200				30	75	10	2	6	◦	
G78 1200 075 1200 030	12	12		75	12	0.3	6	•	G80 1200 075 1200 030	12	12	30	75	12	0.3	6	◦		
G78 1200 075 1200 050				75	12	0.5	6	•	G80 1200 075 1200 050				30	75	12	0.5	6	◦	
G78 1200 075 1200 100				75	12	1	6	◦	G80 1200 075 1200 100				30	75	12	1	6	◦	
G7 1200 075 1200 200				75	12	2	6	•	G80 1200 075 1200 200				30	75	12	2	6	•	

ALU LINE
 EZ LINE -
 ENDMILL
 SE 30
 NITICO 30
 OPTIMUM
 SE 45
 SE 45X
 NITICO 45
 SE 60
 SE 60X
 DN70 -
 SE 70
 SE GR
 TE 45
 PLUNGE
 -MILL
 THREAD
 MILL

CNC Repeatability
 Ø1 - Ø3 within 10µm
 Ø4 - Ø8 within 15µm
 ≥ Ø10 within 20µm

Material Group | Material-Gruppe | Groupe Matière | Gruppo Materiali | 材质主类

N01
N02
N03
K01
K02
P01
P02
P03
M01
M02
S01
S02
S03
H01
H02
O01
O02

Cutting Parameter

284

SE 60X FIN-MILL TORUS LONG ENDMILLS / WITH RECESS, 4 - 6 FLUTES

- VHM SE 60X Fin-mill Torusfräser, lang, 4 / 6 Zähne
- Frese ad alto avanzamento toroidali lunghe SE 60X, 4 - 6 taglienti
- Fraises 2 tailles SE 60X Fin-mill toriques longues, 4 - 6 dents
- 整体硬质合金 SE60X Fin-mill 系列 4/6刃长型圆鼻铣刀

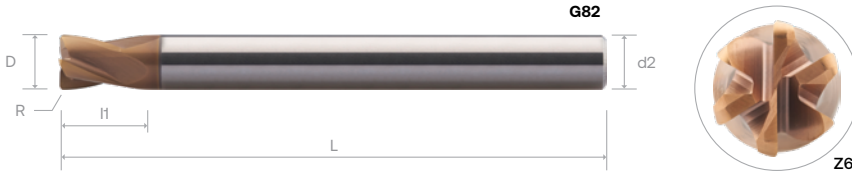

Order Number	Dimension (mm)								B0909	Order Number	Dimension (mm)								B0909
	D	I1	I2	L	d2 (h6)	R	Z	D			I1	I2	L	d2 (h6)	R	Z			
G82 0200 075 0600 030	2	2		75	6	0.3	4	•	G84 0200 075 0600 030	2	2	35	75	6	0.3	4	◦		
G82 0200 075 0600 050				75	6	0.5	4	◦				G84 0200 075 0600 050		35	75	6	0.5	4	◦
G82 0300 075 0600 030	3	3		75	6	0.3	4	◦	G84 0300 075 0600 030	3	3	30	75	6	0.3	4	◦		
G82 0300 075 0600 050				75	6	0.5	4	◦				G84 0300 075 0600 050		30	75	6	0.5	4	◦
G82 0400 075 0600 030	4	4		75	6	0.3	4	◦	G84 0400 075 0600 030	4	4	32	75	6	0.3	4	◦		
G82 0400 075 0600 050				75	6	0.5	4	◦				G84 0400 075 0600 050		32	75	6	0.5	4	•
G82 0600 075 0600 030	6	6		75	6	0.3	4	◦	G84 0600 075 0600 030	6	6	40	75	6	0.3	4	◦		
G82 0600 075 0600 050				75	6	0.5	4	◦				G84 0600 075 0600 050		40	75	6	0.5	4	◦
G82 0600 075 0600 100				75	6	1	4	•				G84 0600 075 0600 100		40	75	6	1	4	◦
G82 0800 100 0800 030	8	8		100	8	0.3	6	◦	G84 0800 100 0800 030	8	8	60	100	8	0.3	6	◦		
G82 0800 100 0800 050				100	8	0.5	6	•				G84 0800 100 0800 050		60	100	8	0.5	6	◦
G82 0800 100 0800 100				100	8	1	6	◦				G84 0800 100 0800 100		60	100	8	1	6	◦
G82 0800 100 0800 200				100	8	2	6	◦				G84 0800 100 0800 200		60	100	8	2	6	◦
G82 1000 100 1000 030	10	10		100	10	0.3	6	◦	G84 1000 100 1000 030	10	10	60	100	10	0.3	6	◦		
G82 1000 100 1000 050				100	10	0.5	6	•				G84 1000 100 1000 050		60	100	10	0.5	6	◦
G82 1000 100 1000 100				100	10	1	6	◦				G84 1000 100 1000 100		60	100	10	1	6	◦
G82 1000 100 1000 200				100	10	2	6	•				G84 1000 100 1000 200		60	100	10	2	6	◦
G82 1200 100 1200 030	12	12		100	12	0.3	6	◦	G84 1200 100 1200 030	12	12	60	100	12	0.3	6	◦		
G82 1200 100 1200 050				100	12	0.5	6	◦				G84 1200 100 1200 050		60	100	12	0.5	6	◦
G82 1200 100 1200 100				100	12	1	6	◦				G84 1200 100 1200 100		60	100	12	1	6	◦
G82 1200 100 1200 200				100	12	2	6	•				G84 1200 100 1200 200		60	100	12	2	6	◦

CNC Repeatability
 Ø1 - Ø3 within 10µm
 Ø4 - Ø8 within 15µm
 ≥ Ø10 within 20µm

Material Group | Material-Gruppe | Groupe Matière | Gruppo Materiali | 材质主类

Cutting Parameter

N01	N02	N03	K01	K02	P01	P02	P03	M01	M02	S01	S02	S03	H01	H02	O01	O02	284
-----	-----	-----	-----	-----	-----	-----	-----	-----	-----	-----	-----	-----	-----	-----	-----	-----	-----

SE 60X FIN-MILL TORUS ENDMILLS WITH LONG NECK, 2 - 4 FLUTES

- VHM SE 60X Fin-Mill Torus-Kleinstfräser mit langem Hals, 2/4 Zähne
- Micro-frese ad alto avanzamento toroidali SE 60X, con collo conico, 2 - 4 taglienti
- Micro-fraises SE 60X Fin-Mill 2 - 4 tailles toriques avec cou long, 2 dents
- 整体硬质合金 SE 60X Fin-Mill 系列 圆鼻长颈短刃 立铣刀 2/4 刃

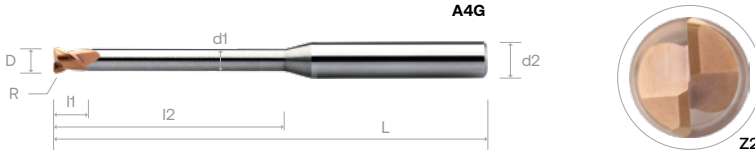
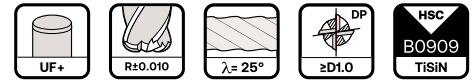

Order Number	Dimension (mm)								B0909	Order Number	Dimension (mm)								B0909	
	D	l1	l2	L	d1	R	d2(h6)	Z			D	l1	l2	L	d1	R	d2(h6)	Z		
A4G 0020 050 0400 R005	0.2	0.2	-	50	-	0.05	4	2	•	A4G 0100 060 0400 R030	1	1	-	60	-	0.3	4	4	•	
A4G 0020 050 0400 005 R005			0.5	50	0.17	0.05	4	2	•				A4G 0100 060 0400 200 R030	20	60	0.9	0.3	4	4	•
A4G 0020 050 0400 010 R005			1	50	0.17	0.05	4	2	•				A4G 0150 050 0400 R010	-	50	-	0.1	4	4	•
A4G 0020 050 0400 015 R005	0.3	0.3	1.5	50	0.17	0.05	4	2	•	A4G 0150 050 0400 060 R010	1.5	1.5	6	50	1.4	0.1	4	4	•	
A4G 0020 050 0400 020 R005			2	50	0.17	0.05	4	2	•	A4G 0150 050 0400 080 R010			8.0	50	1.4	0.1	4	4	•	
A4G 0030 050 0400 R005			-	50	-	0.05	4	2	•	A4G 0150 050 0400 120 R010			12	50	1.4	0.1	4	4	•	
A4G 0030 050 0400 010 R005			1	50	0.27	0.05	4	2	•	A4G 0150 050 0400 160 R010			16	50	1.4	0.1	4	4	•	
A4G 0030 050 0400 015 R005			1.5	50	0.27	0.05	4	2	•	A4G 0150 060 0400 R010			-	60	-	0.1	4	4	•	
A4G 0030 050 0400 020 R005			2	50	0.27	0.05	4	2	•	A4G 0150 060 0400 200 R010			20	60	1.4	0.1	4	4	•	
A4G 0030 050 0400 025 R005	0.4	0.4	2.5	50	0.27	0.05	4	2	•	A4G 0150 050 0400 R020	1.5	1.5	-	50	-	0.2	4	4	•	
A4G 0030 050 0400 030 R005			3	50	0.27	0.05	4	2	•	A4G 0150 050 0400 060 R020			6.0	50	1.4	0.2	4	4	•	
A4G 0040 050 0400 R005			-	50	-	0.05	4	2	•	A4G 0150 050 0400 080 R020			8.0	50	1.4	0.2	4	4	•	
A4G 0040 050 0400 010 R005	0.5	0.5	1	50	0.37	0.05	4	2	•	A4G 0150 050 0400 100 R020	1.5	1.5	10	50	1.4	0.2	4	4	•	
A4G 0040 050 0400 015 R005			1.5	50	0.37	0.05	4	2	•	A4G 0150 050 0400 120 R020			12	50	1.4	0.2	4	4	•	
A4G 0040 050 0400 020 R005			2	50	0.37	0.05	4	2	•	A4G 0150 050 0400 140 R020			14	50	1.4	0.2	4	4	•	
A4G 0040 050 0400 025 R005			2.5	50	0.37	0.05	4	2	•	A4G 0150 050 0400 160 R020			16	50	1.4	0.2	4	4	•	
A4G 0040 050 0400 030 R005			3	50	0.37	0.05	4	2	•	A4G 0150 060 0400 R020			-	60	-	0.2	4	4	•	
A4G 0040 050 0400 035 R005			3.5	50	0.37	0.05	4	2	•	A4G 0150 060 0400 180 R020			18	60	1.4	0.2	4	4	•	
A4G 0040 050 0400 040 R005	0.6	0.6	4	50	0.37	0.05	4	2	•	A4G 0150 060 0400 200 R020	2	2	20	60	1.4	0.2	4	4	•	
A4G 0050 050 0400 R005			-	50	-	0.05	4	2	•	A4G 0150 050 0400 R030			-	50	-	0.3	4	4	•	
A4G 0050 050 0400 010 R005			1	50	0.45	0.05	4	2	•	A4G 0150 050 0400 080 R030			8.0	50	1.4	0.3	4	4	•	
A4G 0050 050 0400 020 R005			2	50	0.45	0.05	4	2	•	A4G 0150 050 0400 160 R030			16	50	1.4	0.3	4	4	•	
A4G 0050 050 0400 030 R005			3	50	0.45	0.05	4	2	•	A4G 0150 060 0400 R030			-	60	-	0.3	4	4	•	
A4G 0050 050 0400 040 R005			4	50	0.45	0.05	4	2	•	A4G 0200 050 0400 R020			20	60	1.4	0.3	4	4	•	
A4G 0050 050 0400 060 R005	0.8	0.8	6	50	0.45	0.05	4	2	•	A4G 0200 050 0400 060 R020	2	2	6	50	1.9	0.2	4	4	•	
A4G 0060 050 0400 R010			-	50	-	0.1	4	2	•	A4G 0200 050 0400 080 R020			8	50	1.9	0.2	4	4	•	
A4G 0060 050 0400 020 R010			2	50	0.55	0.1	4	2	•	A4G 0200 050 0400 100 R020			10	50	1.9	0.2	4	4	•	
A4G 0060 050 0400 040 R010			4	50	0.55	0.1	4	2	•	A4G 0200 050 0400 120 R020			12	50	1.9	0.2	4	4	•	
A4G 0060 050 0400 060 R010			6	50	0.55	0.1	4	2	•	A4G 0200 050 0400 140 R020			14	50	1.9	0.2	4	4	•	
A4G 0060 050 0400 080 R010			8	50	0.55	0.1	4	2	•	A4G 0200 050 0400 160 R020			16	50	1.9	0.2	4	4	•	
A4G 0060 050 0400 100 R010	1	1	10	50	0.55	0.1	4	2	•	A4G 0200 060 0400 R020	2.5	2.5	-	60	-	0.2	4	4	•	
A4G 0080 050 0400 R010			-	50	-	0.1	4	2	•	A4G 0200 060 0400 180 R020			18	60	1.9	0.2	4	4	•	
A4G 0080 050 0400 040 R010			4	50	0.75	0.1	4	2	•	A4G 0200 060 0400 200 R020			20	60	1.9	0.2	4	4	•	
A4G 0080 050 0400 060 R010			6	50	0.75	0.1	4	2	•	A4G 0200 075 0400 R020			-	75	-	0.2	4	4	•	
A4G 0080 050 0400 080 R010			8	50	0.75	0.1	4	2	•	A4G 0200 075 0400 250 R020			25	75	1.9	0.2	4	4	•	
A4G 0080 050 0400 120 R010			12	50	0.75	0.1	4	2	•	A4G 0200 075 0400 300 R020			30	75	1.9	0.2	4	4	•	
A4G 0100 050 0400 040 R010	1	1	-	50	-	0.1	4	4	•	A4G 0200 050 0400 R030	2	2	-	50	-	0.3	4	4	•	
A4G 0100 050 0400 060 R010			4	50	0.9	0.1	4	4	•	A4G 0200 050 0400 080 R030			8	50	1.9	0.3	4	4	•	
A4G 0100 050 0400 080 R010			6	50	0.9	0.1	4	4	•	A4G 0200 050 0400 160 R030			16	50	1.9	0.3	4	4	•	
A4G 0100 050 0400 100 R010			8	50	0.9	0.1	4	4	•	A4G 0200 060 0400 R030			-	60	-	0.3	4	4	•	
A4G 0100 050 0400 120 R010			10	50	0.9	0.1	4	4	•	A4G 0200 060 0400 200 R030			20	60	1.9	0.3	4	4	•	
A4G 0100 050 0400 140 R010			12	50	0.9	0.1	4	4	•	A4G 0200 050 0400 R050			6	50	1.9	0.5	4	4	•	
A4G 0100 050 0400 160 R010	14	50	0.9	0.1	4	4	•	A4G 0200 050 0400 060 R050	8	50	1.9	0.5	4	4	•					
A4G 0100 050 0400 200 R010	16	50	0.9	0.1	4	4	•	A4G 0200 050 0400 080 R050	12	50	1.9	0.5	4	4	•					
A4G 0100 075 0400 R010	1	1	-	75	-	0.1	4	4	•	A4G 0200 050 0400 120 R050	2.5	2.5	12	50	1.9	0.5	4	4	•	
A4G 0100 075 0400 200 R010			20	75	0.9	0.1	4	4	•	A4G 0200 050 0400 160 R050			16	50	1.9	0.5	4	4	•	
A4G 0100 050 0400 R020			-	50	-	0.2	4	4	•	A4G 0200 060 0400 R050			-	60	-	0.5	4	4	•	
A4G 0100 050 0400 040 R020			4	50	0.9	0.2	4	4	•	A4G 0200 060 0400 200 R050			20	60	1.9	0.5	4	4	•	
A4G 0100 050 0400 060 R020			6	50	0.9	0.2	4	4	•	A4G 0200 075 0400 R050			-	75	-	0.5	4	4	•	
A4G 0100 050 0400 080 R020			8	50	0.9	0.2	4	4	•	A4G 0200 075 0400 250 R050			25	75	1.9	0.5	4	4	•	
A4G 0100 050 0400 100 R020	10	50	0.9	0.2	4	4	•	A4G 0200 075 0400 300 R050	30	75	1.9	0.5	4	4	•					
A4G 0100 050 0400 120 R020	12	50	0.9	0.2	4	4	•	A4G 0250 050 0400 R030	-	50	-	0.3	4	4	•					
A4G 0100 050 0400 140 R020	14	50	0.9	0.2	4	4	•	A4G 0250 050 0400 080 R030	8	50	2.4	0.3	4	4	•					
A4G 0100 050 0400 160 R020	16	50	0.9	0.2	4	4	•	A4G 0250 050 0400 100 R030	10	50	2.4	0.3	4	4	•					
A4G 0100 060 0400 R020	-	60	-	0.2	4	4	•	A4G 0250 050 0400 120 R030	12	50	2.4	0.3	4	4	•					
A4G 0100 060 0400 200 R020	20	60	0.9	0.2	4	4	•	A4G 0250 050 0400 140 R030	14	50	2.4	0.3	4	4	•					
A4G 0100 050 0400 R030	-	50	-	0.3	4	4	•	A4G 0250 050 0400 160 R030	16	50	2.4	0.3	4	4	•					
A4G 0100 050 0400 060 R030	6	50	0.9	0.3	4	4	•	A4G 0250 060 0400 R030	-	60	-	0.3	4	4	•					
A4G 0100 050 0400 100 R030	10	50	0.9	0.3	4	4	•	A4G 0250 060 0400 180 R030	18	60	2.4	0.3	4	4	•					
A4G 0100 050 0400 160 R030	16	50	0.9	0.3	4	4	•	A4G 0250 060 0400 200 R030	20	60	2.4	0.3	4	4	•					

cont'd ▶

Material Group | Material-Gruppe | Groupe Matière | Gruppo Materiali | 材质主类

Cutting Parameter

N01	N02	N03	K01	K02	P01	P02	P03	M01	M02	S01	S02	S03	H01	H02	O01	O02	286 - 287
-----	-----	-----	-----	-----	-----	-----	-----	-----	-----	-----	-----	-----	-----	-----	-----	-----	-----------

SE 60X FIN-MILL TORUS ENDMILLS WITH TAPER NECK, 4 FLUTES

- VHM SE 60X Fin-mill Standard Torusfräser, 4 Zähne
- Frese ad alto avanzamento toroidali SE6 0X, con collo conico, 4 taglienti
- Fraises 2 tailles SE 60X Fin-mill toriques - Standard, cou conique 4 dents
- 整体硬质合金 SE 60X Fin-mill 系列 圆鼻 立铣刀 4 刃 - 标准长度



Order Number	Dimension (mm)									Interference Angle	Effective Wall Gradient Angle			B0909
	D	l1	l2	l3	d1	L	d2 (h6)	y	R		1°	2°	3°	
A4F 0100 015 06 010 R010	1.0	1.0	2.0	15	1.35	60	6	1°	0.1	8.31°	15.08	15.35	15.61	◦
A4F 0100 020 06 010 R010			2.0	20	1.53	60	6	1°	0.1	6.47°	20.08	20.43	20.78	◦
A4F 0100 025 06 010 R010			2.0	25	1.70	60	6	1°	0.1	5.30°	25.08	25.52	25.96	◦
A4F 0100 030 06 010 R010			2.0	30	1.88	75	6	1°	0.1	4.49°	30.08	30.61	31.13	◦
A4F 0100 035 06 010 R010			2.0	35	2.05	75	6	1°	0.1	3.89°	35.08	35.70	36.31	◦
A4F 0100 006 06 030 R010			2.0	6	1.32	60	6	3°	0.1	17.07°	-	6.04	6.15	◦
A4F 0100 010 06 030 R010			2.0	10	1.74	60	6	3°	0.1	11.83°	-	-	10.14	◦
A4F 0100 020 06 010 R020			2.0	20	1.53	60	6	1°	0.2	6.50°	20.08	20.43	20.78	◦
A4F 0100 025 06 010 R020			2.0	25	1.70	60	6	1°	0.2	5.32°	25.08	25.52	25.95	◦
A4F 0100 030 06 010 R020			2.0	30	1.88	75	6	1°	0.2	4.50°	30.08	30.60	31.13	◦
A4F 0100 035 06 010 R020			2.0	35	2.05	75	6	1°	0.2	3.90°	35.08	35.69	36.30	◦
A4F 0100 006 06 030 R020			2.0	6	1.32	60	6	3°	0.2	17.27°	-	6.04	6.14	◦
A4F 0100 010 06 030 R020	2.0	10	1.74	60	6	3°	0.2	11.93°	-	-	10.13	◦		
A4F 0150 015 06 010 R020	1.5	1.5	3.0	15	1.82	60	6	1°	0.2	7.59°	15.10	15.36	15.62	◦
A4F 0150 020 06 010 R020			3.0	20	1.99	60	6	1°	0.2	5.89°	20.10	20.45	20.80	◦
A4F 0150 025 06 010 R020			3.0	25	2.17	60	6	1°	0.2	4.81°	25.10	25.54	25.97	◦
A4F 0150 030 06 010 R020			3.0	30	2.34	75	6	1°	0.2	4.07°	30.10	30.62	31.15	◦
A4F 0150 010 06 030 R020			3.0	10	2.13	60	6	1°	0.2	10.86°	-	10.02	10.19	◦
A4F 0150 015 06 030 R020			3.0	15	2.66	60	6	3°	0.2	7.78°	-	-	15.18	◦
A4F 0150 015 06 010 R030			3.0	15	1.82	60	6	3°	0.3	1.63°	15.10	15.36	15.62	◦
A4F 0150 020 06 010 R030			3.0	20	1.99	60	6	1°	0.3	5.92°	21.10	20.44	20.79	◦
A4F 0150 025 06 010 R030			3.0	25	2.17	60	6	1°	0.3	4.83°	25.10	25.53	25.97	◦
A4F 0150 030 06 010 R030			3.0	30	2.34	75	6	1°	0.3	4.08°	30.10	30.62	31.14	◦
A4F 0150 010 06 030 R030			3.0	10	2.13	60	6	3°	0.3	10.95°	-	10.02	10.18	◦
A4F 0150 015 06 030 R030			3.0	15	2.66	60	6	3°	0.3	7.83°	-	-	15.17	◦
A4F 0200 015 06 010 R020	2.0	2.0	4.0	15	2.28	60	6	1°	0.2	6.85°	15.12	15.38	15.64	◦
A4F 0200 020 06 010 R020			4.0	20	2.46	60	6	1°	0.2	5.30°	20.12	20.47	20.81	◦
A4F 0200 025 06 010 R020			4.0	25	2.63	60	6	1°	0.2	4.32°	25.12	25.55	25.99	◦
A4F 0200 040 06 010 R020			4.0	30	2.81	75	6	1°	0.2	3.46°	30.12	30.64	31.16	◦
A4F 0200 040 06 010 R020			4.0	40	3.61	75	6	1°	0.2	2.78°	40.12	40.82	41.51	◦
A4F 0200 050 06 010 R020			4.0	50	3.51	100	6	1°	0.2	2.24°	50.12	50.99	51.86	◦
A4F 0200 015 06 030 R020			4.0	15	3.05	60	6	3°	0.2	7.01°	-	-	15.24	◦

cont'd ▶

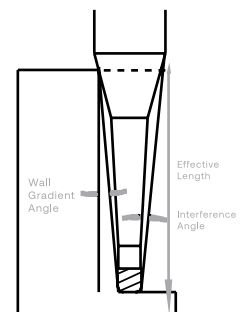

Material Group | Material-Gruppe | Groupe Matière | Gruppo Materiali | 材质主类

N01 N02 N03 K01 K02 P01 P02 P03 M01 M02 S01 S02 S03 H01 H02 O01 O02
288

SE 60X FIN-MILL TORUS ENDMILLS WITH TAPER NECK, 4 FLUTES

- VHM SE 60X Fin-mill Standard Torusfräser, 4 Zähne
- Frese ad alto avanzamento toroidali SE6 0X, con collo conico, 4 taglienti
- Fraises 2 tailles SE 60X Fin-mill toriques - Standard, cou conique 4 dents
- 整体硬质合金 SE 60X Fin-mill 系列 圆鼻 立铣刀 4 刃 - 标准长度

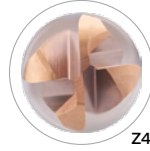
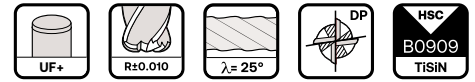

Order Number	Dimension (mm)									Interference Angle	Effective Wall Gradient Angle			B0909		
	D	I1	I2	I3	d1	L	d2 (h6)	y	R		1°	2°	3°			
A4F 0200 020 06 030 R020	2.0	2.0	4.0	20	3.58	60	6	3°	0.2	5.44°	-	-	2023	o		
A4F 0200 015 06 010 R030			4.0	15	2.28	60	6	1°	0.3	6.89°	15.12	15.38	15.63	o		
A4F 0200 020 06 010 R030			4.0	20	2.46	60	6	1°	0.3	5.32°	20.12	20.46	20.81	o		
A4F 0200 025 06 010 R030			4.0	25	2.63	60	6	1°	0.3	4.34°	25.12	25.55	25.98	o		
A4F 0200 030 06 010 R030			4.0	30	2.81	75	6	1°	0.3	3.66°	30.12	30.64	31.16	o		
A4F 0200 040 06 010 R030			4.0	40	3.16	75	6	1°	0.3	2.78°	40.12	40.81	41.51	o		
A4F 0200 050 06 010 R030			4.0	50	3.51	100	6	1°	0.3	2.25°	50.12	50.99	51.86	o		
A4F 0200 015 06 030 R030			4.0	15	3.05	60	6	3°	0.3	7.05°	-	-	15.23	o		
A4F 0200 020 06 030 R030			4.0	20	3.58	60	6	3°	0.3	5.46°	-	-	20.22	o		
A4F 0200 015 06 010 R050			4.0	15	2.28	60	6	1°	0.5	6.97°	15.11	15.37	15.62	o		
A4F 0200 020 06 010 R050			4.0	20	2.46	60	6	1°	0.5	5.37°	20.11	20.46	20.80	o		
A4F 0200 025 06 010 R050			4.0	25	2.63	60	6	1°	0.5	4.37°	25.11	25.54	25.97	o		
A4F 0200 030 06 010 R050			4.0	30	2.81	75	6	1°	0.5	3.68°	30.11	30.63	31.15	o		
A4F 0200 040 06 010 R050			4.0	40	3.16	75	6	1°	0.5	2.80°	40.11	40.80	41.50	o		
A4F 0200 050 06 010 R050			4.0	50	3.51	100	6	1°	0.5	2.26°	50.11	50.98	51.85	o		
A4F 0200 015 06 030 R050			4.0	15	3.05	60	6	3°	0.5	7.14°	-	-	15.22	o		
A4F 0200 020 06 030 R050			4.0	20	3.58	60	6	3°	0.5	5.52°	-	-	20.21	o		
A4F 0300 015 06 010 R020			3.0	3.0	4.0	15	3.18	60	6	1°	0.2	5.29°	15.17	15.43	15.69	o
A4F 0300 020 06 010 R020	6.0	20			3.29	60	6	1°	0.2	4.06°	20.20	20.55	20.90	o		
A4F 0300 030 06 010 R020	6.0	30			3.64	75	6	1°	0.2	2.77°	30.20	30.73	31.25	o		
A4F 0300 040 06 010 R020	6.0	40			3.99	75	6	1°	0.2	2.11°	40.20	40.90	41.60	o		
A4F 0300 050 06 010 R020	6.0	50			4.34	100	6	1°	0.2	1.70°	50.20	51.08	51.95	o		
A4F 0300 060 06 010 R020	6.0	60			4.69	100	6	1°	0.2	1.42°	60.20	61.25	62.30	o		
A4F 0300 015 06 010 R050	4.0	15			3.18	60	6	1°	0.5	5.39°	15.16	15.42	15.68	o		
A4F 0300 020 06 010 R050	6.0	20			3.29	60	6	1°	0.5	4.11°	20.20	20.54	20.89	o		
A4F 0300 030 06 010 R050	6.0	30			3.64	75	6	1°	0.5	2.80°	30.20	30.72	31.24	o		
A4F 0300 040 06 010 R050	6.0	40			3.99	75	6	1°	0.5	2.12°	40.20	40.89	41.59	o		
A4F 0300 050 06 010 R050	6.0	50			4.34	100	6	1°	0.5	1.71°	50.20	51.07	51.94	o		
A4F 0300 060 06 010 R050	6.0	60			4.69	100	6	1°	0.5	1.43°	60.20	61.24	62.29	o		
A4F 0400 020 06 010 R050	4.0	4.0			8.0	20	4.12	75	6	1°	0.5	2.80°	20.29	20.63	20.98	o
A4F 0400 040 06 010 R050					8.0	40	4.82	75	6	1°	0.5	1.43°	40.29	40.98	41.68	o
A4F 0400 050 08 010 R050					6.0	6.0	8.0	50	6.97	100	6	1°	1.0	1.16°	50.38	51.24

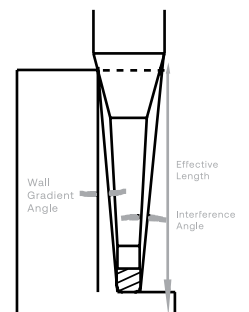

Material Group | Material-Gruppe | Groupe Matière | Gruppo Materiali | 材质主类

N01	N02	N03	K01	K02	P01	P02	P03	M01	M02	S01	S02	S03	H01	H02	O01	O02	288
-----	-----	-----	-----	-----	-----	-----	-----	-----	-----	-----	-----	-----	-----	-----	-----	-----	-----

FEATURES & BENEFITS

SE 60X Double R



Top View

1 Very Large Radius with Center Cutting

- Increase stock removal rate
- Enables higher cutting feed

2 Short Flutes with Corner Radius

- Short flute to increase toughness
- Prolong tool life with reinforce large corner radius



3 Tough PVD Silicon Based Coating

- Prolong the tool life
- Enables higher cutting speeds
- Increases hardness and higher abrasive wear resistance
- Smoother chips evacuation

4 Suitable for Material Groups





1. Sehr großer Radius mit Zentrumschnitt
Erhöhung des Spanvolumens
ermöglicht eine höhere Schnittgeschwindigkeit
2. Kurze Schneiden mit Eckradius
Erhöhung der Zähigkeit durch kurze Schneiden
verlängert die Werkzeuglebensdauer durch
verstärkten großen Eckradius
3. PVD-Silizium-Hartbeschichtung
verlängert die Lebensdauer des Werkzeugs
ermöglicht höhere Schnittgeschwindigkeiten
erhöht die Hitzebeständigkeit, deshalb sehr gut
geeignet für Trockenbearbeitung
4. Geeignet für Materialgruppe P, H



1. 非常大的半径与中心切割
增加材料去屑率。
实现更高的切削进给。
2. 带圆角的短刃
通过短刃提高韧性。
加强大圆角半径,延长刀具寿命。
3. 耐用的 PVD 硅基涂层
延长刀具寿命。
实现更高的切屑速度。
增加耐热性,因此非常适合干式切削。
4. 适用高硬度材料 P, H



1. Raggio molto largo con taglio centrale
Aumenta il tasso di asportazione
Consente avanzamento di taglio superiore
2. Scanalature corte con raggio d'angolo
Aumenta la resistenza grazie alle scanalature corte
Prolunga la vita dello strumento con raggio d'angolo
ampio e rinforzato
3. Rivestimento in silicone PVD resistente
prolunga la vita dello strumento
consente maggiori velocità di taglio
aumenta la resistenza al calore ed è quindi adatto per
la lavorazione a secco
4. Adatto per Materiale P, H



1. Rayon très large avec coupe au centre
augmente le taux d'évacuation du matériau
2. Augmente la résistance grâce aux goujures courtes
Prolonge la durée de vie de l'outil grâce double rayon
3. Revêtement à base de silicium sous forme de dépôt
en phase vapeur résistant
prolonge la durée de vie de l'outil
permet des vitesses de coupe supérieures
augmente la résistance à la chaleur, donc parfaitement
adapté à l'usinage à sec
4. Adapté au matériaux P, H

815 / A98



SE 60X DOUBLE R BALLNOSE CUTTERS, 2 FLUTES

- VHM SE 60X Double R Radiusfräser, 2 Zähne
- Frese sferiche SE 60X Double R, 4 taglienti
- Fraises SE 60X Double R, à bout hémisphérique
- 整体硬质合金 SE 60X Double R 系列 球头 立铣刀 2 刃 - 标准长度

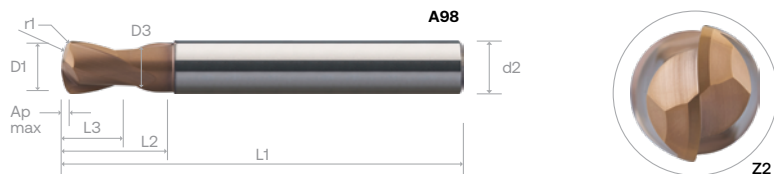
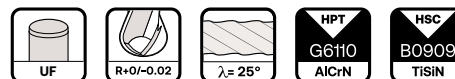

Order Number	Dimension (mm)										G6110	Order Number	Dimension (mm)										B0909
	D1	D3	L1	L2	L3	r1	r2	Ap max	d2 (h6)				D1	D3	L1	L2	L3	r1	r2	Ap max	d2 (h6)		
815 0400	4	3.90	50	9	4	0.5	4	0.8	6	°	A98 0400	4	3.90	50	9	4	0.5	4	0.8	6	•		
815 0500	5	4.90		11	5	0.6	5	1	6	°	A98 0500	5	4.90		11	5	0.6	5	1	6	°		
815 0600	6	5.90		13	6	0.8	6	1.2	6	°	A98 0600	6	5.90		13	6	0.8	6	1.2	6	•		
815 0800	8	7.90	64	19	8	1	8	1.6	8	°	A98 0800	8	7.90	64	19	8	1	8	1.6	8	°		
815 1000	10	9.90	75	21	10	1.5	10	2.2	10	°	A98 1000	10	9.90	75	21	10	1.5	10	2.2	10	°		
815 1200	12	11.90		25	12	2	12	2.8	12	°	A98 1200	12	11.90		25	12	2	12	2.8	12	•		
815 1600	16	15.90	90	33	16	2.5	16	3.6	16	°	A98 1600	16	15.90	90	33	16	2.5	16	3.6	16	°		

ALU LINE
 EZ LINE - ENDMILL
 SE 30
 NITICO 30
 OPTIMUM
 SE 45
 SE 45X
 SE 45X
 NITICO 45
 SE 60
 SE 60X
 DN70 - SE70
 SE GR
 TE 45
 PLUNGE -MILL
 THREAD MILL

Ø mm	HPMT Standard
0.1 - 3.0	-10 / -25
3.0 - 6.0	-10 / -38
6.0 - 10.0	-10 / -50
10.0 - 12.0	-10 / -50

Material Group | Material-Gruppe | Groupe Matière | Gruppo Materiali | 材质主类

N01	N02	N03	K01	K02	P01	P02	P03	M01	M02	S01	S02	S03	H01	H02	O01	O02	285 - 286
-----	-----	-----	-----	-----	-----	-----	-----	-----	-----	-----	-----	-----	-----	-----	-----	-----	-----------

Cutting Parameter

FEATURES & BENEFITS

SE 60X Sweep-Mill



Top View

1 4/6 Flutes

- 2x to 3x feed rate in comparison with conventional 2 flutes cutter
- Short flute to increase toughness
- Prolongs tool life by having more flutes

2 Very Large Radius

- Increases stock removal rate
- Enables higher cutting feed



3 Tough PVD Silicon Based Coating

- Prolong the tool life
- Enables higher cutting speeds
- Increases hardness and higher abrasive wear resistance
- Smoother chips evacuation

4 Suitable for Material Groups





1. 4/6 Schneiden
zwei- bzw. dreifacher Vorschub gegenüber Fräsern
mit 2 Schneiden
höhere Belastbarkeit durch kurze Schneiden
verlängerte Werkzeuglebensdauer durch mehr
Schneiden
2. Sehr großer Radius
höheres Spanvolumen
ermöglicht höhere Schnittgeschwindigkeit
3. PVD-Silizium-Hartbeschichtung
verlängert die Lebensdauer des Werkzeugs
ermöglicht höhere Schnittgeschwindigkeiten
erhöht die Hitzebeständigkeit, deshalb sehr gut
geeignet für Trockenbearbeitung
4. Geeignet für Materialgruppe P, H



1. 4/6 刃
与常规的 2 刃刀具相比, 进给速率提高 2 倍或 3 倍。
通过短刃设计增加刀具韧性。
通过更多的刀刃数延长刀具寿命。
2. 较大的圆角
增加铁料去除能力。
实现更高的切削进给。
3. 耐用的 PVD 硅基涂层
延长刀具寿命。
实现更高的切屑速度。
增加耐热性, 因此非常适合干式切削。
4. 适用高硬度材料 P、H



1. 4/6 scanalature
velocità di avanzamento 2 o 3 volte maggiore rispetto
a cutter tradizionali a 2 scanalature
aumenta la resistenza grazie ad una scanalatura corta
Prolunga la vita dello strumento grazie a più
scanalature
2. Raggio molto grande
Aumenta il tasso di asportazione
Consente avanzamento di taglio superiore
3. Rivestimento in silicene PVD resistente
prolunga la vita dello strumento
consente maggiori velocità di taglio
aumenta la resistenza al calore ed è quindi adatto per
la lavorazione a secco
4. Adatto per Materiale P, H



1. 4/6 goujures
Débit 2 à 3 fois plus élevé que les dispositifs de coupe
conventionnels à 2 goujures
augmente la résistance grâce aux goujures courtes
2. Rayons extrêmement larges
augmente le taux d'évacuation du matériau
permet un débit copeaux optimum
3. Revêtement à base de silicium sous forme de dépôt
en phase vapeur résistant
prolonge la durée de vie de l'outil
permet des vitesses de coupe supérieures
augmente la résistance à la chaleur, donc parfaitement
adapté à l'usinage à sec
4. Adapté au matériaux P, H

SE 60X SWEEP-MILL TORUS ENDMILLS, 4 - 6 FLUTES

- VHM SE 60X Sweep-Mill Torusfräser, 4/6 Schneiden
- Frese ad alto avanzamento toroidali per finitura SE 60X, 4 - 6 taglienti
- Fraises 2 tailles toriques SE 60X Sweep-Mill, 4 - 6 dents, pour opération d'ébauche
- 整体硬质合金 SE 60X Sweep-Mill 系列 圆鼻立铣刀4/6刃



Order Number	Dimension (mm)							B0909
	D	I1	I2	L	d2 (h6)	R (theo)	Z	
G86 0300 057 0600 060	3	1.5	6	57	6	0.3	4	•
G86 0300 057 0600 120			12	57	6	0.3	4	◦
G86 0400 057 0600 080	4	1.5	8	57	6	0.4	4	•
G86 0400 057 0600 150			15	57	6	0.4	4	•
G86 0500 057 0600 100	5	2	10	57	6	0.5	4	•
G86 0500 057 0600 210			22	57	6	0.5	4	◦
G86 0600 057 0600 120	6	2.5	12	57	6	0.6	4	•
G86 0600 057 0600 260			26	57	6	0.6	4	•
G86 0800 063 0800 160	8	3	16	63	8	0.8	6	•
G86 0800 063 0800 310			32	63	8	0.8	6	•
G86 1000 072 1000 200	10	3.5	20	72	10	1	6	•
G86 1000 072 1000 360			36	72	10	1	6	◦
G86 1200 083 1200 240	12	4	24	83	12	1.2	6	•
G86 1200 083 1200 410			43	83	12	1.2	6	◦

Ø mm	HPMT Standard
0.1 < 3.0	-10 / -25
3.0 ~ 6.0	-10 / -38
6.0 ~ 10.0	-10 / -50
10.0 ~ 12.0	-10 / -50

Material Group | Material-Gruppe | Groupe Matière | Gruppo Materiali | 材质主类

Cutting Parameter

N01	N02	N03	K01	K02	P01	P02	P03	M01	M02	S01	S02	S03	H01	H02	O01	O02	285
-----	-----	-----	-----	-----	-----	-----	-----	-----	-----	-----	-----	-----	-----	-----	-----	-----	-----

Recommended Cutting Data



Note: These recommended cutting data indicators are just for reference. They should be adjusted according to the different cutting condition



SE 60X Fin-Mill Torus Endmills, 4 Flutes - G78, G80

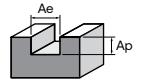

Face Milling	P		H			
Working Material	Prehardened steel		Hardened steel		Hardened steel	
Properties	35 ≤ HRC < 45		45 ≤ HRC < 52		52 ≤ HRC < 68	
Cutting depth, ap	0.05 × D		0.05 × D		0.05 × D	
Cutting Width, ae	0.40 × D		0.35 × D		0.15 × D	
D	Vc	Fz	Vc	Fz	Vc	Fz
2	150	0.021	130	0.019	110	0.018
3		0.037		0.033		0.031
4		0.060		0.055		0.052
6		0.092		0.085		0.082

SE 60X Fin-Mill Torus Endmills, 6 Flutes - G78, G80

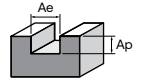

Face Milling	P		H			
Working Material	Prehardened steel		Hardened steel		Hardened steel	
Properties	35 ≤ HRC < 45		45 ≤ HRC < 52		52 ≤ HRC < 68	
Cutting depth, ap	0.05 × D		0.05 × D		0.05 × D	
Cutting Width, ae	0.40 × D		0.35 × D		0.30 × D	
D	Vc	Fz	Vc	Fz	Vc	Fz
8	150	0.096	130	0.088	110	0.085
10		0.125		0.114		0.110
12		0.155		0.145		0.140

SE 60X Fin-Mill Torus Long Endmills, 4 Flutes - G82, G84

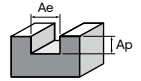

Face Milling	P		H			
Working Material	Prehardened steel		Hardened steel		Hardened steel	
Properties	35 ≤ HRC < 45		45 ≤ HRC < 52		52 ≤ HRC < 68	
Cutting depth, ap	0.05 × D		0.05 × D		0.05 × D	
Cutting Width, ae	0.35 × D		0.30 × D		0.25 × D	
D	Vc	Fz	Vc	Fz	Vc	Fz
2	135	0.019	115	0.017	100	0.016
3		0.033		0.031		0.029
4		0.055		0.051		0.048
6		0.086		0.080		0.076

SE 60X Fin-Mill Torus Long Endmills, 6 Flutes - G82, G84

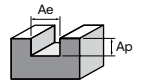

Face Milling	P		H			
Working Material	Prehardened steel		Hardened steel		Hardened steel	
Properties	35 ≤ HRC < 45		45 ≤ HRC < 52		52 ≤ HRC < 68	
Cutting depth, ap	0.05 × D		0.05 × D		0.05 × D	
Cutting Width, ae	0.35 × D		0.30 × D		0.25 × D	
D	Vc	Fz	Vc	Fz	Vc	Fz
8	135	0.090	115	0.084	100	0.080
10		0.120		0.110		0.105
12		0.150		0.140		0.135

ALU LINE
EZ LINE -
ENDMILL
SE 30
NITCO 30
OPTIMUM
SE 45
SE 45X
NITCO 45
SE 60
SE 60X
DN70 -
SE 70
SE GR
TE 45
PLUNGE
-MILL
THREAD
MILL

Recommended Cutting Data



Note: These recommended cutting data indicators are just for reference. They should be adjusted according to the different cutting condition



SE 60X Sweep-Mill Torus Endmill, 4 Flutes - G86

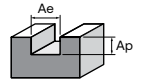

Face Milling		P		H		
Working Material	Prehardened steel		Hardened steel		Hardened steel	
Properties	35 ≤ HRC < 45		45 ≤ HRC < 52		52 ≤ HRC < 68	
Cutting depth, ap	0.05 × D		0.04 × D		0.03 × D	
Cutting Width, ae	0.40 × D		0.35 × D		0.30 × D	
D	Vc	Fz	Vc	Fz	Vc	Fz
3	160	0.062	140	0.060	120	0.060
4		0.087		0.085		0.083
5		0.114		0.112		0.110
6		0.142		0.140		0.138

SE 60X Sweep-Mill Torus Endmill, 6 Flutes - G86

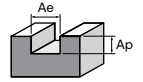

Face Milling		P		H		
Working Material	Prehardened steel		Hardened steel		Hardened steel	
Properties	35 ≤ HRC < 45		45 ≤ HRC < 52		52 ≤ HRC < 68	
Cutting depth, ap	0.05 × D		0.04 × D		0.03 × D	
Cutting Width, ae	0.40 × D		0.35 × D		0.30 × D	
D	Vc	Fz	Vc	Fz	Vc	Fz
8	160	0.144	140	0.142	120	0.140
10		0.184		0.182		0.180
12		0.227		0.225		0.220

SE 60X Double R Ballnose Cutter, 2 Flutes - 815, A98

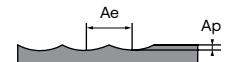

Roughing		P		H		
Working Material	Prehardened steel		Hardened steel		Hardened steel	
Properties	35 ≤ HRC < 45		45 ≤ HRC < 52		52 ≤ HRC < 68	
Cutting depth, ap	0.03 × D		0.03 × D		0.03 × D	
Cutting Width, ae	0.40 × D		0.35 × D		0.30 × D	
D	Vc	Fz	Vc	Fz	Vc	Fz
4	180	0.041	130	0.038	100	0.036
5		0.055		0.052		0.049
6		0.070		0.067		0.064
8		0.097		0.092		0.087
10		0.124		0.117		0.110
12		0.157		0.145		0.140
16		0.200		0.190		0.180

ALU LINE
ENDMILL
SE 30
SE 30
NITCo 30
OPTIMUM
SE 45
SE 45X
SE 45X
NITCo 45
SE 60
SE 60X
DM70 - SE70
SE GR
TE 45
PLUNGE -MILL
THREAD MILL

Recommended Cutting Data



Note: These recommended cutting data indicators are just for reference. They should be adjusted according to the different cutting condition



SE 60X Double R Ballnose Cutter, 2 Flutes - 815, A98

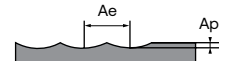

Finishing	P		H			
Working Material	Prehardened steel		Hardened steel		Hardened steel	
Properties	35 ≤ HRC < 45		45 ≤ HRC < 52		52 ≤ HRC < 68	
Cutting depth, ap	0.05 × D		0.05 × D		0.05 × D	
Cutting Width, ae	0.05 × D		0.05 × D		0.05 × D	
D	Vc	Fz	Vc	Fz	Vc	Fz
4	200	0.034	150	0.029	120	0.025
5		0.045		0.040		0.034
6		0.058		0.052		0.045
8		0.081		0.071		0.062
10		0.104		0.091		0.078
12		0.132		0.113		0.100
16		0.170		0.148		0.130

SE 60X Fin-Mill Torus Endmills With Miniature Long Neck, 2 Flutes - A4G

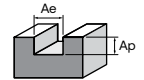

Slotting		H					
Working Material		Hardened steel			Hardened steel		
Properties		45 ≤ HRC < 52			52 ≤ HRC < 68		
D	Effective Length	Ap	N	Fz	Ap	N	Fz
0.2	0.5	0.016	41000	0.004		37000	0.004
	1.0	0.013	40000	0.004	0.012	36000	0.004
	1.5	0.010	38200	0.004	0.009	35000	0.004
	2.0	0.004	38200	0.003	0.004	31800	0.003
0.3	1.0	0.010	33900	0.005	0.009	33900	0.005
	1.5	0.011	32000	0.005	0.010	31000	0.005
	2.0	0.006	30800	0.005	0.005	27600	0.005
	2.5	0.005	28500	0.004	0.005	26500	0.004
0.4	3.0	0.004	27600	0.004	0.004	25500	0.004
	1.0	0.016	25500	0.007	0.014	23900	0.007
	1.5	0.013	24300	0.006	0.012	23900	0.006
	2.0	0.010	23100	0.006	0.009	23900	0.006
	2.5	0.009	22100	0.005	0.008	21000	0.005
	3.0	0.009	21500	0.005	0.008	19900	0.005
0.5	3.5	0.007	20500	0.004	0.007	18500	0.004
	4.0	0.005	19900	0.004	0.005	16700	0.004
	1.0	0.020	25500	0.008	0.018	24200	0.008
	2.0	0.015	24200	0.007	0.014	22900	0.007
	3.0	0.011	22900	0.007	0.010	21600	0.007
	4.0	0.011	22300	0.006	0.010	19100	0.006
0.6	5.0	0.007	22300	0.006	0.006	17200	0.006
	6.0	0.005	20400	0.005	0.005	15300	0.005
	2.0	0.023	25500	0.010	0.021	24400	0.010
	4.0	0.016	23300	0.009	0.014	21700	0.009
	6.0	0.010	22300	0.008	0.009	17000	0.008
	8.0	0.008	21200	0.007	0.007	15900	0.007
0.8	10.0	0.006	20200	0.006	0.005	15400	0.006
	4.0	0.021	25900	0.011	0.019	24700	0.011
	6.0	0.012	23900	0.009	0.011	21500	0.009
	8.0	0.010	22300	0.008	0.009	17100	0.008
	12.0	0.008	19900	0.007	0.007	15500	0.007

ALU LINE
EZ LINE -
ENDMILL
SE 30
NITCO 30
OPTIMUM
SE 45
SE 45X
NITCO 45
SE 60
SE 60X
DN70 -
SE 70
SE GR
TE 45
PLUNGE
-MILL
SE 70
THREAD
MILL

Recommended Cutting Data



Note: These recommended cutting data indicators are just for reference. They should be adjusted according to the different cutting condition



SE 60X Fin-Mill Torus Endmills With Miniature Long Neck, 4 Flutes - A4G

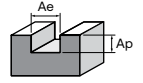

Slotting		H					
Working Material		Hardened steel			Hardened steel		
Properties		45 ≤ HRC < 52			52 ≤ HRC < 68		
D	Effective Length	Ap	N	Fz	Ap	N	Fz
1.0	4.0	0.025	22000	0.013	0.023	21300	0.013
	6.0	0.016	20700	0.011	0.014	20400	0.011
	8.0	0.016	19700	0.011	0.014	19100	0.011
	10.0	0.010	19700	0.009	0.009	19100	0.009
	12.0	0.010	19100	0.009	0.009	18500	0.009
	14.0	0.008	18800	0.008	0.007	18100	0.008
	16.0	0.006	18500	0.008	0.005	17800	0.008
	20.0	0.004	17500	0.008	0.004	17200	0.008
1.5	6.0	0.042	17000	0.017	0.038	18500	0.017
	8.0	0.039	17000	0.017	0.035	17600	0.017
	10.0	0.039	15900	0.017	0.035	14900	0.017
	12.0	0.039	15900	0.017	0.035	14000	0.017
	14.0	0.029	15900	0.015	0.026	13200	0.015
	16.0	0.029	14900	0.015	0.026	12500	0.015
	18.0	0.025	14900	0.013	0.023	11700	0.013
	20.0	0.020	13800	0.013	0.018	11000	0.013
2.0	6.0	0.052	16200	0.018	0.047	12700	0.018
	8.0	0.046	14600	0.018	0.041	12700	0.018
	10.0	0.036	13400	0.018	0.032	12700	0.018
	12.0	0.026	11900	0.017	0.023	11900	0.017
	14.0	0.026	11900	0.017	0.023	11100	0.017
	16.0	0.026	11300	0.017	0.023	10700	0.017
	18.0	0.025	10700	0.016	0.023	9900	0.016
	20.0	0.023	9900	0.016	0.021	9200	0.016
	25.0	0.016	9900	0.015	0.014	9200	0.015
30.0	0.011	9400	0.015	0.010	8800	0.015	
2.5	8.0	0.062	13200	0.021	0.056	12300	0.021
	10.0	0.059	12900	0.021	0.053	11800	0.021
	12.0	0.055	12200	0.021	0.050	11500	0.021
	14.0	0.051	11600	0.020	0.046	10800	0.020
	16.0	0.047	11100	0.020	0.042	10300	0.020
	18.0	0.043	10400	0.019	0.039	9800	0.019
	20.0	0.039	9900	0.018	0.035	9300	0.018
	25.0	0.029	9700	0.018	0.026	9000	0.018
30.0	0.020	9400	0.017	0.018	8800	0.017	
3.0	8.0	0.059	10600	0.024	0.053	10100	0.024
	10.0	0.052	10600	0.024	0.047	10100	0.024
	12.0	0.046	10100	0.024	0.041	9500	0.024
	14.0	0.039	10100	0.022	0.035	9500	0.022
	16.0	0.033	9500	0.022	0.030	9000	0.022
	18.0	0.033	9500	0.020	0.030	9000	0.020
	20.0	0.033	9000	0.020	0.030	8500	0.020
	25.0	0.029	8500	0.018	0.026	8000	0.018
30.0	0.026	7600	0.018	0.023	7100	0.018	
4.0	10.0	0.150	8000	0.028	0.135	7600	0.028
	15.0	0.133	7600	0.026	0.120	7200	0.026
	20.0	0.117	7300	0.026	0.105	6900	0.026
	25.0	0.111	7200	0.024	0.100	6800	0.024
	32.0	0.098	6800	0.022	0.088	6400	0.022
40.0	0.085	6400	0.022	0.077	6000	0.022	

ALU LINE
EZ LINE -
SE 30
NITCo 30
OPTIMUM
SE 45
SE 45X
NITCo 45
SE 60
SE 60X
DM70 -
SE 70
SE GR
TE 45
PLUNGE
-MILL
THREAD
MILL

Recommended Cutting Data



Note: These recommended cutting data indicators are just for reference. They should be adjusted according to the different cutting condition



SE 60X Fin-Mill Torus Endmills With Miniature Taper Neck, 2 Flutes - A4F

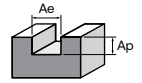

Slotting		H					
Working Material		Hardened steel			Hardened steel		
Properties		45 ≤ HRC < 52			52 ≤ HRC < 68		
D	Effective Length	Ap	N	Fz	Ap	N	Fz
1.0	6	0.020	20700	0.018	0.018	18800	0.015
	10	0.013	20100	0.016	0.012	15900	0.014
	15	0.008	20100	0.015	0.007	14300	0.013
	20	0.008	18500	0.014	0.007	14300	0.012
	25	0.006	16500	0.013	0.005	12700	0.011
	30	0.006	14300	0.012	0.005	11800	0.010
	35	0.004	13400	0.011	0.003	11100	0.009
1.5	10	0.034	15900	0.019	0.020	14900	0.017
	15	0.026	14900	0.017	0.015	14400	0.015
	20	0.017	13800	0.016	0.010	12700	0.014
	25	0.014	12700	0.015	0.009	11700	0.013
	30	0.011	11700	0.014	0.007	10600	0.012
2.0	15	0.040	12100	0.022	0.024	11800	0.020
	20	0.030	12100	0.021	0.018	11800	0.019
	25	0.024	11100	0.018	0.014	10800	0.016
	30	0.020	11100	0.017	0.012	10800	0.015
	40	0.015	10300	0.015	0.009	10000	0.013
	50	0.012	10300	0.013	0.007	10000	0.011
3.0	15	0.117	8500	0.030	0.084	8000	0.028
	20	0.068	8500	0.028	0.041	8000	0.026
	30	0.045	8000	0.026	0.027	7400	0.024
	40	0.034	7400	0.024	0.020	6900	0.022
	50	0.027	6900	0.022	0.016	6400	0.020
	60	0.023	6400	0.020	0.014	5800	0.018
4.0	20	0.118	6800	0.035	0.069	6400	0.033
	40	0.061	6000	0.030	0.035	5600	0.028
6.0	50	0.108	4500	0.028	0.066	4200	0.026

ALU LINE
 EZ LINE -
 ENDMILL
 SE 30
 NITCO 30
 OPTIMUM
 SE 45
 SE 45X
 NITCO 45
 SE 60
SE 60X
 DN70 -
 SE 70
 SE GR
 TE 45
 PLUNGE
 -MILL
 THREAD
 MILL

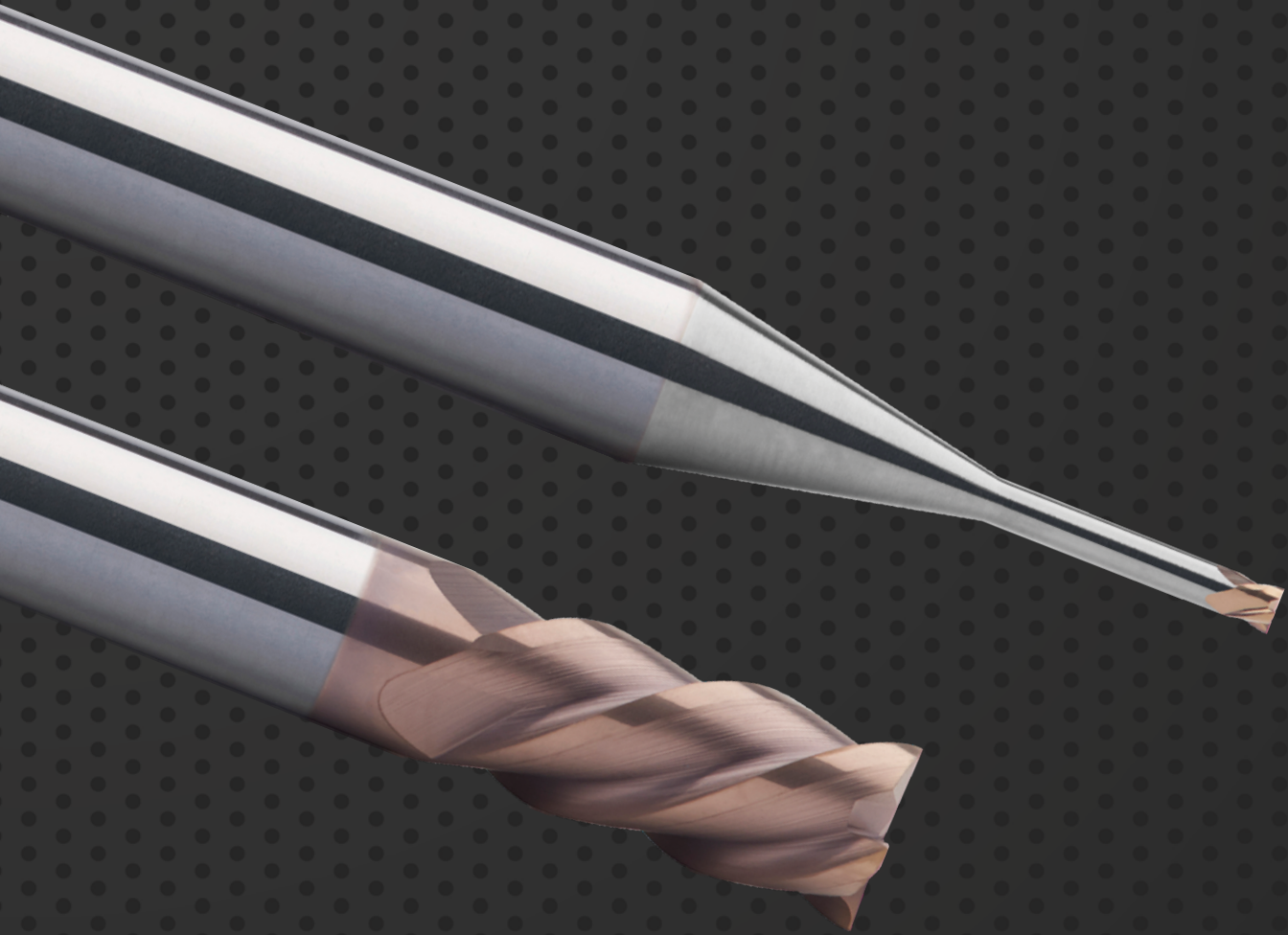

ENDMILLS











DM70 (SE 70)

For Mould & Die applications on hard material
For material application up to 70 HRC

Index - DM70 (SE 70), For 50 - 70 HRC

Suitable for Material Groups
 Adapté pour les matériaux
 适用于材料
 Geeignet für die Materialgruppen
 Adatto per il materiale

H

	EDP Number	Type	No. Z	Helix Angle	Coating	Performance	Page Number
NEW	A5F 	SE 70	4	43°	B0909+	P	295
NEW	A5M 	SE 70, Recess	4	43°	B0909+	P	295
NEW	A5H 	SE 70R Torus	4	30°	B0909+	P	298
NEW	A5J 	SE 70R Torus, Recess	4	30°	B0909+	P	298
NEW	A5D 	SE 70 Miniature Long Neck	2	30°	B0909+	P	302
NEW	A5E 	SE 70 Miniature Long Neck	4	30°	B0909+	P	304
NEW	A5G 	SE 70R Miniature Torus Long Neck	2/4	30°	B0909+	P	307 / 308
NEW	K73 	SE 70 DH Multiflutes Torus	6/7	a° ≠ b°	B0909	P	313
NEW	K76 	SE 70 DH Multiflutes, Recess	6/7	a° ≠ b°	B0909	P	316
NEW	K77 	SE 70 DH Multiflutes	6/7	a° ≠ b°	B0909	P	316

G - General P - Performance

DM70 (SE 70)

MAIN FEATURES * Only applicable for A5D, A5E, A5F, A5G, A5H, A5J and A5M.

1 New Improved Coating formula (B0909+)

- Higher hardness coating with higher silicon content
- Increased machining speed capability when cutting materials >50HRC
- Higher abrasive wear resistance, allowing for longer tool life
- Enhanced heat resistance for hard machining materials

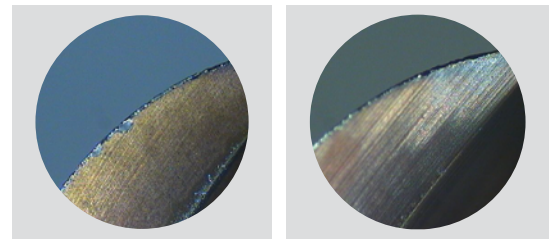

2 Tightened Tolerance

- Higher eccentricity and higher concentricity
- Perfect for modern high precision tool holders
- Deliver high precision machining

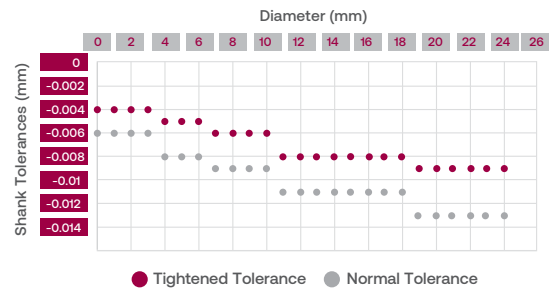

3 Cutting Edge Preparation

- Better stress distribution on the cutting edge to prolong tool life
- Reduced micro chipping and uneven sharp edges for superior surface finishing
- Minimize material adhesion on the cutting edge; reduces burring chance

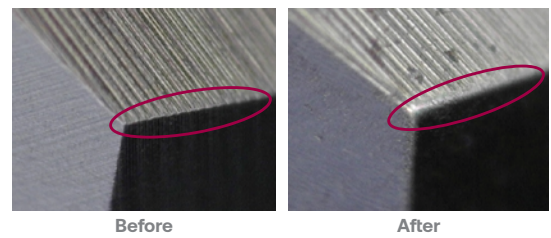

4 Ultra Fine Grain Cemented Carbide (UF+)

- Higher durability for material removal rate (MRR)
- Higher overall tool toughness, strength and edge retention
- Excellent performance in machining high hardness materials
- Reduce the risk of chipping and increases reliability

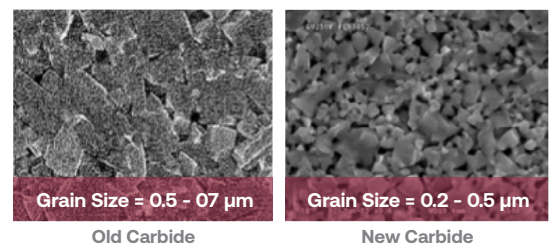



1. verbesserte Beschichtung (B0909+)
Beschichtung mit höherem Siliziumgehalt
höhere Bearbeitungsgeschwindigkeit beim Schneiden von Materialien >50HRC
höhere Verschleißfestigkeit, dadurch längere Werkzeugstandzeit
Verbesserte Hitzebeständigkeit beim Schneiden von Materialien >50HRC
2. engere Toleranz
Höhere Exzentrizität und höhere Rundlaufgenauigkeit
Perfekt für moderne Präzisionswerkzeugaufnahmen
Lieferrn hochpräzise Bearbeitungen
3. Schneidkantenpräparation
Bessere Belastungsverteilung an der Schneide zur Verlängerung der Werkzeugstandzeit
Geringere Mikroausbrüche und ungleichmäßige scharfe Kanten für eine bessere Oberflächengüte
Minimierung der Materialanhaftung an der Schneidkante; reduziert die Gratbildung.
4. ultrafeinkörniges Hartmetall (UF+)
höhere Standzeit bei der Materialabtragsrate
höhere Werkzeugfestigkeit, Beständigkeit und Kantenstabilität.
ausgezeichnete Leistung bei der Bearbeitung von härteren Stählen.
verringert das Risiko von Ausbrüchen und erhöht die Zuverlässigkeit



1. 新改良的涂层配方(B0909+)
含硅量较高的高硬度涂层
使用于材料 >50HRC 时, 有较高的加工速度
更高的耐磨性可延长刀具寿命
增强高硬度加工材料的耐热性
2. 缩小公差
具有更高的偏心率和同心度
完美配合于先进高精度夹持工具
可用于高精度加工
3. 刃口处理
改善切削刃上的应力分布可延长刀具寿命
减少微小崩损及不均匀刃锋, 提高工件光洁度
最大限度地减少切削刃上的材料沾黏; 减少毛刺产生
4. 超细颗粒硬质合金 (UF+)
材料去除率 (MRR) 的耐久性更高
更高的韧性、强度和刃口坚固
加工高硬度材料的性能更优越
减轻崩损, 提高稳定性



1. Formula migliorata del rivestimento (B0909+)
Rivestimento di maggiore durezza con un contenuto di silicio più elevato
Maggiore velocità di lavorazione durante il taglio di materiali >50HRC
Maggiore resistenza all'usura, che consente una maggiore durata dell'utensile
Maggiore resistenza al calore per materiali di lavorazione duri
2. Tolleranze piu' strette
Maggiore precisione di concentricità
Ideale per i moderni portautensili ad alta precisione
Fornire lavorazioni di alta precisione
3. Preparazione del tagliente
Migliore distribuzione delle sollecitazioni sul tagliente per prolungare la durata dell'utensile
Riduce le microscheggiature del tagliente per una migliore finitura superficiale
Riduce al minimo l'incollatura del materiale sul tagliente e la possibilità di sbavature
4. Metallo duro cementato a grana ultra fine (UF+)
Maggiore durata per alta rimozione del materiale (MRR)
Maggiore tenacità dell'utensile, resistenza e durata del tagliente
Eccellenti prestazioni nella lavorazione di materiali temprati
Riduce il rischio di scheggiatura e aumenta l'affidabilità



1. Nouvelle formule de revêtement améliorée (B0909+)
Revêtement de dureté plus élevée avec une teneur en silicium plus élevée
Capacité de vitesse d'usinage accrue lors de la coupe de matériaux > 50HRC
Résistance à l'usure abrasive plus élevée, permettant une durée de vie plus longue de l'outil
Résistance à la chaleur améliorée pour les matériaux d'usinage durs
2. Resserrer la tolérance
Excentricité et concentricité plus élevées
Parfait pour les porte-outils modernes de haute précision
Fournir un usinage de haute précision
3. Préparation de pointe
Meilleure répartition des contraintes sur l'arête de coupe pour prolonger la durée de vie de l'outil
Micro-écaillage réduit et arêtes vives inégales pour une finition de surface supérieure
Minimiser l'adhérence du matériau sur l'arête de coupe ; réduit les risques de bavures
4. Carbone cémenté à grain ultra fin (UF+)
Durabilité plus élevée pour le taux d'enlèvement de matière (MRR)
Plus grande ténacité globale de l'outil, résistance et rétention des bords
Excellentes performances dans l'usinage de matériaux de haute dureté
Réduit le risque d'écaillage et augmente la fiabilité

FEATURES & BENEFITS

DM70 (SE 70)



Top View

1 Gash Land Design



- Reinforce edge protection of the cutting tool corner
- Higher mechanical strength to withstand greater cutting force
- Longer machining time consistency and greater tool durability

2 Higher Helix Angle

- Lower radial cutting force to reduce vibration during machining
- Better shearing to deliver higher quality of surface finishing
- Higher efficient in chip evacuation with lower engagement in cutting edge

3 Suitable for Material

H





1. Stirnschliff Design
Verstärkung des Kantenschutzes der Schneidekanten.
Höhere mechanische Festigkeit, um größeren
Schneidkräften auszuhalten.
konstante Bearbeitungszeit und höhere
Werkzeugstandzeit
 2. Hoher Drallwinkel
Geringere radiale Schnittkraft zur Reduzierung von Vibrationen
während der Bearbeitung
Bessere Scherung für eine höhere Qualität der Oberflächengüte.
Höhere Effizienz bei der Spanabfuhr mit geringerem
Eingriff in die Schneidkante
 3. Geeignet für Materialgruppe H
-



1. 刃带设计
强化刃锋保护
应用于高强度切削时,提供更好的抗力
可延长加工时间并提高刀具的耐用性
 2. 高螺旋角
降低径向切削力以减少加工过程中的振动
更佳的切削,提高工件光洁度
更有效排屑,更少的刃口接触
 3. 适用于加工材料H
-



1. Disegno della scanalatura
Maggior protezione dell'elica del tagliente
Maggiore resistenza meccanica alla forza di taglio
Maggiore regolarità dei tempi di lavorazione
2. Angolo d'elica elevato
Forza di taglio radiale inferiore per ridurre le vibrazioni
Migliore qualità della finitura superficiale
Maggiore efficienza nell'evacuazione del truciolo
3. Adatto per il materiale H



1. Conception de la terre d'entaille
Renforcer la protection des bords du coin de l'outil de
coupe
Résistance mécanique plus élevée pour résister à une
force de coupe plus importante
Une durée d'usinage plus longue et une plus grande
durabilité de l'outil
2. Angle d'hélice élevé
Force de coupe radiale inférieure pour réduire les
vibrations pendant l'usinage
Meilleur cisaillement pour une meilleure qualité de finition
de surface
Plus efficace dans l'évacuation des copeaux avec
un engagement plus faible dans l'arête de coupe
3. Adapté aux matériaux H

SE 70 ENDMILLS / WITH RECESS, 4 FLUTES

- VHM SE 70 Fräser, 4 Zähne
- Frese SE 70, 4 taglienti
- Fraises SE 70, 4 dents
- 整体硬质合金 SE 70 系列 4刃平底铣刀

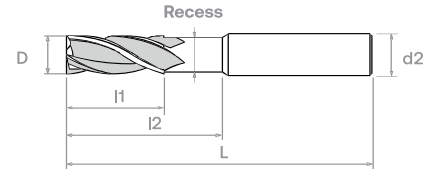
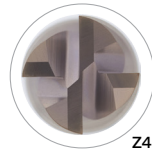

Order Number	Dimension (mm)						B0909+	Order Number	Dimension (mm)						B0909+	
	D	l1	l2	L	d1	d2 (h6)			D	l1	l2	L	d1	d2 (h6)		
A5F 0100 050 04	1	2.5		50	0.95	4	•	A5M 0100 050 04	1	2.5	4	50	0.95	4	◦	
A5F 0100 050 06				50	0.95	6	◦	A5M 0100 050 06			6	50	0.95	6	◦	
A5F 0150 050 04	1.5	4		50	1.45	4	•	A5M 0150 050 04	1.5	4	6	50	1.45	4	◦	
A5F 0150 050 06				50	1.45	6	◦	A5M 0150 050 06			9	50	1.45	6	◦	
A5F 0200 050 04	2	6		50	1.94	4	•	A5M 0200 050 04	2	6	8	50	1.94	4	◦	
A5F 0200 050 06				50	1.94	6	•	A5M 0200 050 06			12	50	1.94	6	◦	
A5F 0250 050 04	2.5	8		50	2.4	4	◦	A5M 0250 050 04	2.5	8	10	50	2.4	4	◦	
A5F 0250 050 06				50	2.4	6	◦	A5M 0250 050 06			15	50	2.4	6	◦	
A5F 0300 050 04	3	8		50	2.85	4	•	A5M 0300 050 04	3	8	12	50	2.85	4	◦	
A5F 0300 050 06				50	2.85	6	•	A5M 0300 050 06			15	50	2.85	6	◦	
A5F 0400 050 04	4	11		50	3.8	4	•	A5M 0400 050 04	4	11	16	50	3.8	4	◦	
A5F 0400 050 06				50	3.8	6	•	A5M 0400 050 06			20	50	3.8	6	•	
A5F 0400 075 04	5	15		75	3.8	4	•	A5M 0400 075 04	5	15	20	75	3.8	4	◦	
A5F 0500 060 06				60	4.8	6	•	A5M 0500 060 06			20	60	4.8	6	◦	
A5F 0600 060 06 13	6	20		60	5.8	6	•	A5M 0600 060 06 13	6	20	22	60	5.8	6	•	
A5F 0600 060 06 20				60	5.8	6	•	A5M 0600 060 06 20			24	60	5.8	6	◦	
A5F 0600 075 06	8	25		75	5.8	6	•	A5M 0600 075 06	8	25	20	75	5.8	6	◦	
A5F 0600 100 06				100	5.8	6	•	A5M 0600 100 06			24	100	5.8	6	◦	
A5F 0800 075 08	10	30		75	7.8	8	•	A5M 0800 075 08	10	30	25	75	7.8	8	•	
A5F 0800 100 08				100	7.8	8	•	A5M 0800 100 08			25	100	7.8	8	◦	
A5F 1000 075 10	12	35		75	9.8	10	•	A5M 1000 075 10	12	35	22	30	75	9.8	10	◦
A5F 1000 100 10 25				100	9.8	10	•	A5M 1000 100 10 25			25	30	100	9.8	10	◦
A5F 1000 100 10 30	16	40		100	9.8	10	•	A5M 1000 100 10 30	16	40	35	100	9.8	10	◦	
A5F 1000 125 10				125	9.8	10	◦	A5M 1000 125 10			30	35	125	9.8	10	◦
A5F 1000 150 10	20	40		150	9.8	10	•	A5M 1000 150 10	20	40	35	150	9.8	10	◦	
A5F 1200 075 12				75	11.7	12	•	A5M 1200 075 12			25	35	75	11.7	12	◦
A5F 1200 100 12 30	25	40		100	11.7	12	•	A5M 1200 100 12 30	25	40	30	35	100	11.7	12	◦
A5F 1200 100 12 35				100	11.7	12	•	A5M 1200 100 12 35			40	100	11.7	12	◦	
A5F 1200 150 12	32	40		150	11.7	12	◦	A5M 1200 150 12	32	40	40	150	11.7	12	◦	
A5F 1600 090 16 32				90	15	16	•	A5M 1600 090 16 32			48	90	15	16	◦	
A5F 2000 100 20 40	40	40		100	19	20	◦	A5M 2000 100 20 40	60	100	19	20	◦			

Diameter (mm)	Tolerance
< 1	+0 -0.005
1 ≤ D ≤ 2.5	+0 -0.010
2.5 ≤ D ≤ 6	+0 -0.015
6 < D ≤ 10	-0.005 -0.020
> 10	-0.010 -0.025

Material Group | Material-Gruppe | Groupe Matière | Gruppo Materiali | 材质主类

Cutting Parameter

N01	N02	N03	K01	K02	P01	P02	P03	M01	M02	S01	S02	S03	H01	H02	O01	O02	317
-----	-----	-----	-----	-----	-----	-----	-----	-----	-----	-----	-----	-----	-----	-----	-----	-----	-----

FEATURES & BENEFITS

DM70 (SE 70R)



Top View

1 S-Gash Radius Design



- Perfect joining between corner radius and outer diameter to achieve higher accuracy radius contour
- More reliability corner radius with lower risk of chipping
- Better surface finishing quality
- Stronger corner radius design to increase tool life
- More quiet during machining and good to production machinist well-being

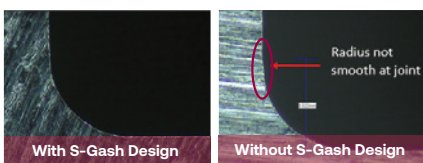

2 Differential Pitch (DP) Design



- Unequal flute spacing to break up harmonic resonance and reduce chatter
- Higher machining stability and improve the surface finishing quality
- Increases tool life and productivity performance

3 Suitable for Material





1. S-Gash-Radius Geometrie
perfekte Übergänge zwischen Eckenradius und Außendurchmesser für eine höhere Genauigkeit der Radiuskontur
zuverlässigerer Eckenradius mit geringerem Risiko von Ausbrüchen
bessere Oberflächengüte bei der Bearbeitung von Bauteilen
verstärkte Eckenradien zur Erhöhung der Werkzeugstandzeit
ruhiger bei der Bearbeitung und gut für das Wohlbefinden des Produktionsmitarbeiters.
2. ungleiche Teilung
ungleiche Anordnung der Spannuten, um Eigenresonanz aufzulösen und Vibrationen zu reduzieren
Höhere Bearbeitungssicherheit und Verbesserung der Oberflächengüte
erhöht die Werkzeugstandzeit und Produktivität
3. Geeignet für die Materialien H



1. 刃带弧度设计
圆角半径与外径之间的完美连接, 以实现更高精度的半径轮廓
更可靠的圆弧可降低崩损风险
具有更好的加工部件表面精加工质量
更强的圆角半径设计以延长刀具寿命
可降低加工过程中的噪音, 有利于作业人员的健康
2. 不等分 (DP) 设计
不等距的刃口, 可避免共振
提高刀具表面精加工质量和稳定性
延长刀具寿命和提高其生产率性能
3. 适用于加工材料H



1. Disegno del profilo della scanalatura
Raccordo ideale tra il profilo interno e il diametro esterno
Minor rischio di scheggiatura
Migliore qualità di finitura superficiale
Maggior durata dell'utensile
Lavorazione piu' dolce
2. Disegno del passo differenziale (DP)
Passo differenziale per rompere la risonanza armonica e ridurre il rumore
Maggiore stabilità di lavorazione e miglior finitura
Aumenta la durata dell'utensile e la produttività
3. Adatto per il materiale H



1. Conception de rayon S-Gash
Jointure parfaite entre le rayon d'angle et le diamètre extérieur pour obtenir un contour de rayon plus précis
Rayon d'angle plus fiable avec moins de risque d'écaillage
Meilleure qualité de finition de surface sur le composant d'usinage
Conception de rayon de coin plus fort pour augmenter la durée de vie de l'outil
Plus silencieux pendant l'usinage et bon pour le bien-être des machinistes de production
2. Conception à pas différentiel (DP)
Espacement inégal des flûtes pour briser la résonance harmonique et réduire le bavardage
Stabilité d'usinage plus élevée et amélioration de la qualité de finition de surface
Augmente la durée de vie de l'outil et les performances de productivité
3. Adapté aux matériaux H

SE 70R TORUS ENDMILLS / WITH RECESS, 4 FLUTES

- VHM SE 70R Standard Torusfräser, 4 Zähne
- Frese toroidali SE 70R, 4 taglienti
- Fraises SE 70R toriques, 4 dents
- 整体硬质合金 SE 70R 系列 4刃圆鼻铣刀

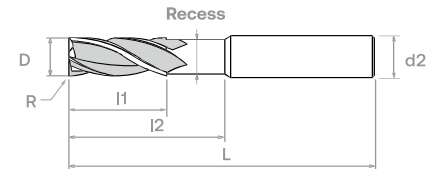
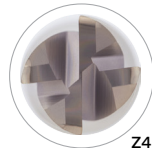
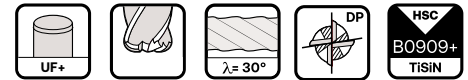

Order Number	Dimension (mm)								BO909+	Order Number	Dimension (mm)								BO909+	
	D	l1	l2	L	d1	d2(h5)	R	Z			D	l1	l2	L	d1	d2(h5)	R	Z		
A5H 0100 050 0400 010	1	2.5		50	0.95	4	0.1	4	°	A5J 0100 050 0400 010	1	2.5	6	50	0.95	4	0.1	4	°	
A5H 0100 050 0400 020				50	0.95	4	0.2	4	•	A5J 0100 050 0400 020				6	50	0.95	4	0.2	4	°
A5H 0100 050 0400 030				50	0.95	4	0.3	4	°	A5J 0100 050 0400 030				6	50	0.95	4	0.3	4	°
A5H 0150 050 0400 010	1.5	4		50	1.45	4	0.1	4	°	A5J 0150 050 0400 010	1.5	4	9	50	1.45	4	0.1	4	°	
A5H 0150 050 0400 020				50	1.45	4	0.2	4	•	A5J 0150 050 0400 020				9	50	1.45	4	0.2	4	°
A5H 0150 050 0400 030				50	1.45	4	0.3	4	°	A5J 0150 050 0400 030				9	50	1.45	4	0.3	4	°
A5H 0150 050 0400 050				50	1.45	4	0.5	4	°	A5J 0150 050 0400 050				9	50	1.45	4	0.5	4	°
A5H 0200 050 0400 010	2	6		50	1.94	4	0.1	4	°	A5J 0200 050 0400 010	2	6	12	50	1.94	4	0.1	4	°	
A5H 0200 050 0400 020				50	1.94	4	0.2	4	•	A5J 0200 050 0400 020				12	50	1.94	4	0.2	4	°
A5H 0200 050 0400 030				50	1.94	4	0.3	4	°	A5J 0200 050 0400 030				12	50	1.94	4	0.3	4	°
A5H 0200 050 0400 050				50	1.94	4	0.5	4	°	A5J 0200 050 0400 050				12	50	1.94	4	0.5	4	°
A5H 0250 050 0400 010	2.5	6		50	2.4	4	0.1	4	°	A5J 0250 050 0400 010	2.5	6	15	50	2.4	4	0.1	4	°	
A5H 0250 050 0400 020				50	2.4	4	0.2	4	°	A5J 0250 050 0400 020				15	50	2.4	4	0.2	4	°
A5H 0250 050 0400 030				50	2.4	4	0.3	4	°	A5J 0250 050 0400 030				15	50	2.4	4	0.3	4	°
A5H 0250 050 0400 050				50	2.4	4	0.5	4	°	A5J 0250 050 0400 050				15	50	2.4	4	0.5	4	°
A5H 0300 050 0400 010	3	8		50	2.85	4	0.1	4	°	A5J 0300 050 0400 010	3	8	12	50	2.85	4	0.1	4	°	
A5H 0300 060 0600 010				60	2.85	6	0.1	4	°	A5J 0300 060 0600 010				15	60	2.85	6	0.1	4	°
A5H 0300 050 0400 020				50	2.85	4	0.2	4	•	A5J 0300 050 0400 020				12	50	2.85	4	0.2	4	°
A5H 0300 060 0600 020				60	2.85	6	0.2	4	°	A5J 0300 060 0600 020				15	60	2.85	6	0.2	4	°
A5H 0300 050 0400 030				50	2.85	4	0.3	4	•	A5J 0300 050 0400 030				12	50	2.85	4	0.3	4	°
A5H 0300 060 0600 030				60	2.85	6	0.3	4	°	A5J 0300 060 0600 030				15	60	2.85	6	0.3	4	°
A5H 0300 050 0400 050				50	2.85	4	0.5	4	°	A5J 0300 050 0400 050				12	50	2.85	4	0.5	4	°
A5H 0300 060 0600 050				60	2.85	6	0.5	4	°	A5J 0300 060 0600 050				15	60	2.85	6	0.5	4	°
A5H 0300 050 0400 100				50	2.85	4	1	4	°	A5J 0300 050 0400 100				12	50	2.85	4	1	4	°
A5H 0300 060 0600 100				60	2.85	6	1	4	°	A5J 0300 060 0600 100				15	60	2.85	6	1	4	°
A5H 0400 060 0400 010	4	9		60	3.8	4	0.1	4	°	A5J 0400 060 0400 010	4	9	16	60	3.8	4	0.1	4	°	
A5H 0400 075 0600 010		10		75	3.8	6	0.1	4	°	A5J 0400 075 0600 010		10	20	75	3.8	6	0.1	4	°	
A5H 0400 060 0400 020		9		60	3.8	4	0.2	4	•	A5J 0400 060 0400 020		9	16	60	3.8	4	0.2	4	°	
A5H 0400 075 0600 020		10		75	3.8	6	0.2	4	°	A5J 0400 075 0600 020		10	20	75	3.8	6	0.2	4	°	
A5H 0400 060 0400 030		9		60	3.8	4	0.3	4	°	A5J 0400 060 0400 030		9	16	60	3.8	4	0.3	4	°	
A5H 0400 075 0600 030		10		75	3.8	6	0.3	4	•	A5J 0400 075 0600 030		10	20	75	3.8	6	0.3	4	°	
A5H 0400 060 0400 050		9		60	3.8	4	0.5	4	°	A5J 0400 060 0400 050		9	16	60	3.8	4	0.5	4	°	
A5H 0400 075 0600 050		10		75	3.8	6	0.5	4	°	A5J 0400 075 0600 050		10	20	75	3.8	6	0.5	4	°	
A5H 0400 060 0400 100		9		60	3.8	4	1	4	°	A5J 0400 060 0400 100		9	16	60	3.8	4	1	4	°	
A5H 0400 075 0600 100		10		75	3.8	6	1	4	°	A5J 0400 075 0600 100		10	20	75	3.8	6	1	4	°	
A5H 0600 060 0600 010	6	11		60	5.8	6	0.1	4	°	A5J 0600 060 0600 010	6	11	24	60	5.8	6	0.1	4	°	
A5H 0600 075 0600 010		13		75	5.8	6	0.1	4	°	A5J 0600 075 0600 010		13	30	75	5.8	6	0.1	4	°	
A5H 0600 060 0600 020		11		60	5.8	6	0.2	4	•	A5J 0600 060 0600 020		11	24	60	5.8	6	0.2	4	°	
A5H 0600 075 0600 020		13		75	5.8	6	0.2	4	°	A5J 0600 075 0600 020		13	30	75	5.8	6	0.2	4	°	
A5H 0600 060 0600 030		11		60	5.8	6	0.3	4	•	A5J 0600 060 0600 030		11	24	60	5.8	6	0.3	4	°	
A5H 0600 075 0600 030		13		75	5.8	6	0.3	4	°	A5J 0600 075 0600 030		13	30	75	5.8	6	0.3	4	°	
A5H 0600 060 0600 050		11		60	5.8	6	0.5	4	•	A5J 0600 060 0600 050		11	24	75	5.8	6	0.5	4	°	
A5H 0600 075 0600 050		13		100	5.8	6	0.5	4	•	A5J 0600 075 0600 050		13	30	100	5.8	6	0.5	4	°	
A5H 0600 075 0600 050 20		20		60	5.8	6	0.5	4	•	A5J 0600 075 0600 050 20		20	30	60	5.8	6	0.5	4	°	
A5H 0600 100 0600 050		13		75	5.8	6	0.5	4	°	A5J 0600 100 0600 050		13	30	75	5.8	6	0.5	4	°	
A5H 0600 060 0600 100		11		60	5.8	6	1	4	•	A5J 0600 060 0600 100		11	24	60	5.8	6	1	4	°	
A5H 0600 075 0600 100		13		75	5.8	6	1	4	°	A5J 0600 075 0600 100		13	30	75	5.8	6	1	4	°	
A5H 0600 060 0600 150		11		60	5.8	6	1.5	4	°	A5J 0600 060 0600 150		11	24	60	5.8	6	1.5	4	°	
A5H 0600 075 0600 150		13		75	5.8	6	1.5	4	°	A5J 0600 075 0600 150		13	30	75	5.8	6	1.5	4	°	
A5H 0600 060 0600 200		11		75	5.8	6	2	4	°	A5J 0600 060 0600 200		11	24	75	5.8	6	2	4	°	
A5H 0600 075 0600 200		13		75	5.8	6	2	4	°	A5J 0600 075 0600 200		13	30	75	5.8	6	2	4	°	

cont'd ▶

Diameter (mm)	Radius Tolerance	Diameter (mm)	Tolerance
D ≤ 25	±0.005	< 1	+0 -0.005
3 < D ≤ 6	±0.010	1 ≤ D ≤ 2.5	+0 -0.010
D > 6	±0.015	2.5 ≤ D ≤ 6	+0 -0.015
		6 < D ≤ 10	-0.005 -0.020
		> 10	-0.010 -0.025

Material Group | Material-Gruppe | Groupe Matiere | Gruppo Materiali | 材质主类

Cutting Parameter

N01	N02	N03	K01	K02	P01	P02	P03	M01	M02	S01	S02	S03	H01	H02	O01	O02	318
-----	-----	-----	-----	-----	-----	-----	-----	-----	-----	-----	-----	-----	-----	-----	-----	-----	-----

SE 70R TORUS ENDMILLS / WITH RECESS, 4 FLUTES

- VHM SE 70R Standard Torusfräser, 4 Zähne
- Frese toroidali SE 70R, 4 taglienti
- Fraises SE 70R toriques, 4 dents
- 整体硬质合金 SE 70R 系列 4刃圆鼻铣刀

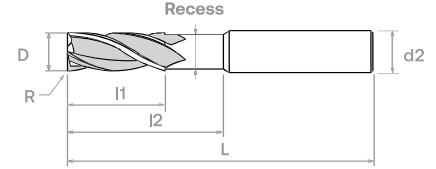

Order Number	Dimension (mm)								B0909+	Order Number	Dimension (mm)								B0909+
	D	I1	I2	L	d1	d2(h5)	R	Z			D	I1	I2	L	d1	d2(h5)	R	Z	
A5H 0800 075 0800 020	8	16	75	7.8	8	0.2	4	°	A5J 0800 075 0800 020	8	16	26	75	7.8	8	0.2	4	°	
A5H 0800 075 0800 030		19	75	7.8	8	0.3	4	°	A5J 0800 075 0800 030		19	26	75	7.8	8	0.3	4	°	
A5H 0800 100 0800 030		19	100	7.8	8	0.3	4	°	A5J 0800 100 0800 030		19	32	100	7.8	8	0.3	4	°	
A5H 0800 075 0800 050 16		16	75	7.8	8	0.5	4	•	A5J 0800 075 0800 050 16		16	26	75	7.8	8	0.5	4	°	
A5H 0800 075 0800 050 19		19	75	7.8	8	0.5	4	•	A5J 0800 075 0800 050 19		19	26	75	7.8	8	0.5	4	°	
A5H 0800 075 0800 050 25		25	75	7.8	8	0.5	4	•	A5J 0800 075 0800 050 25		25	30	75	7.8	8	0.5	4	°	
A5H 0800 100 0800 050		19	100	7.8	8	0.5	4	°	A5J 0800 100 0800 050		19	32	100	7.8	8	0.5	4	°	
A5H 0800 075 0800 100		16	75	7.8	8	1	4	°	A5J 0800 075 0800 100		16	26	75	7.8	8	1	4	°	
A5H 0800 100 0800 100		19	100	7.8	8	1	4	°	A5J 0800 100 0800 100		19	32	100	7.8	8	1	4	°	
A5H 0800 075 0800 150		16	75	7.8	8	1.5	4	°	A5J 0800 075 0800 150		16	26	75	7.8	8	1.5	4	°	
A5H 0800 100 0800 150	19	100	7.8	8	1.5	4	°	A5J 0800 100 0800 150	19	32	100	7.8	8	1.5	4	°			
A5H 0800 075 0800 200	16	75	7.8	8	2	4	°	A5J 0800 075 0800 200	16	26	75	7.8	8	2	4	°			
A5H 0800 100 0800 200	19	100	7.8	8	2	4	°	A5J 0800 100 0800 200	19	32	100	7.8	8	2	4	°			
A5H 1000 075 1000 030	10	19	75	9.8	10	0.3	4	°	A5J 1000 075 1000 030	10	19	30	75	9.8	10	0.3	4	°	
A5H 1000 100 1000 030		22	100	9.8	10	0.3	4	°	A5J 1000 100 1000 030		22	40	100	9.8	10	0.3	4	°	
A5H 1000 075 1000 050 19		19	75	9.8	10	0.5	4	•	A5J 1000 075 1000 050 19		19	30	75	9.8	10	0.5	4	°	
A5H 1000 075 1000 050 25		25	75	9.8	10	0.5	4	•	A5J 1000 075 1000 050 25		25	30	75	9.8	10	0.5	4	°	
A5H 1000 100 1000 050 22		22	100	9.8	10	0.5	4	•	A5J 1000 100 1000 050 22		22	40	100	9.8	10	0.5	4	°	
A5H 1000 100 1000 050 30		30	100	9.8	10	0.5	4	•	A5J 1000 100 1000 050 30		30	40	100	9.8	10	0.5	4	°	
A5H 1000 125 1000 050		22	125	9.8	10	0.5	4	°	A5J 1000 125 1000 050		22	40	125	9.8	10	0.5	4	°	
A5H 1000 150 1000 050		22	150	9.8	10	0.5	4	°	A5J 1000 150 1000 050		22	40	150	9.8	10	0.5	4	°	
A5H 1000 150 1000 050 30		30	150	9.8	10	0.5	4	°	A5J 1000 150 1000 050 30		30	40	150	9.8	10	0.5	4	°	
A5H 1000 075 1000 100		19	75	9.8	10	1	4	°	A5J 1000 075 1000 100		19	30	75	9.8	10	1	4	°	
A5H 1000 100 1000 100	22	100	9.8	10	1	4	°	A5J 1000 100 1000 100	22	40	100	9.8	10	1	4	°			
A5H 1000 075 1000 150	19	75	9.8	10	1.5	4	•	A5J 1000 075 1000 150	19	30	75	9.8	10	1.5	4	°			
A5H 1000 100 1000 150	22	100	9.8	10	1.5	4	°	A5J 1000 100 1000 150	22	40	100	9.8	10	1.5	4	°			
A5H 1000 075 1000 200	19	75	9.8	10	2	4	•	A5J 1000 075 1000 200	19	30	75	9.8	10	2	4	°			
A5H 1000 100 1000 200	22	100	9.8	10	2	4	°	A5J 1000 100 1000 200	22	40	100	9.8	10	2	4	°			
A5H 1000 075 1000 250	19	75	9.8	10	2.5	4	°	A5J 1000 075 1000 250	19	30	75	9.8	10	2.5	4	°			
A5H 1000 100 1000 250	22	100	9.8	10	2.5	4	°	A5J 1000 100 1000 250	22	40	100	9.8	10	2.5	4	°			
A5H 1200 075 1200 030	12	22	75	11.7	12	0.3	4	°	A5J 1200 075 1200 030	12	22	35	75	11.7	12	0.3	4	°	
A5H 1200 100 1200 030		26	100	11.7	12	0.3	4	°	A5J 1200 100 1200 030		26	48	100	11.7	12	0.3	4	°	
A5H 1200 075 1200 050		22	75	11.7	12	0.5	4	•	A5J 1200 075 1200 050		22	35	75	11.7	12	0.5	4	°	
A5H 1200 100 1200 050 26		26	100	11.7	12	0.5	4	°	A5J 1200 100 1200 050 26		26	48	100	11.7	12	0.5	4	°	
A5H 1200 100 1200 050 35		35	100	11.7	12	0.5	4	•	A5J 1200 100 1200 050 35		35	48	100	11.7	12	0.5	4	°	
A5H 1200 150 1200 050 26		26	150	11.7	12	0.5	4	°	A5J 1200 150 1200 050 26		26	48	150	11.7	12	0.5	4	°	
A5H 1200 150 1200 050 35		35	150	11.7	12	0.5	4	°	A5J 1200 150 1200 050 35		35	48	150	11.7	12	0.5	4	°	
A5H 1200 075 1200 100		22	75	11.7	12	1	4	•	A5J 1200 075 1200 100		22	35	75	11.7	12	1	4	°	
A5H 1200 100 1200 100		26	100	11.7	12	1	4	•	A5J 1200 100 1200 100		26	48	100	11.7	12	1	4	°	
A5H 1200 075 1200 150		22	75	11.7	12	1.5	4	°	A5J 1200 075 1200 150		22	35	75	11.7	12	1.5	4	°	
A5H 1200 100 1200 150	26	100	11.7	12	1.5	4	°	A5J 1200 100 1200 150	26	48	100	11.7	12	1.5	4	°			
A5H 1200 075 1200 200	22	75	11.7	12	2	4	•	A5J 1200 075 1200 200	22	35	75	11.7	12	2	4	°			
A5H 1200 100 1200 200	26	100	11.7	12	2	4	°	A5J 1200 100 1200 200	26	48	100	11.7	12	2	4	°			
A5H 1200 075 1200 250	22	75	11.7	12	2.5	4	°	A5J 1200 075 1200 250	22	35	75	11.7	12	2.5	4	°			
A5H 1200 100 1200 250	26	100	11.7	12	2.5	4	°	A5J 1200 100 1200 250	26	48	100	11.7	12	2.5	4	°			
A5H 1200 075 1200 300	22	75	11.7	12	3	4	•	A5J 1200 075 1200 300	22	35	75	11.7	12	3	4	°			
A5H 1200 100 1200 300	26	100	11.7	12	3	4	°	A5J 1200 100 1200 300	26	48	100	11.7	12	3	4	°			
A5H 1600 090 1600 050	16	32	90	15	16	0.5	4	•	A5J 1600 090 1600 050	16	32	48	90	15	16	0.5	4	°	
A5H 1600 090 1600 100		48	90	15	16	1	4	°	A5J 1600 090 1600 100		48	90	15	16	1	4	°		
A5H 2000 100 2000 050		40	100	19	20	0.5	4	°	A5J 2000 100 2000 050		40	60	100	19	20	0.5	4	°	
A5H 2000 100 2000 100	20	100	19	20	1	4	•	A5J 2000 100 2000 100	20	60	100	19	20	1	4	°			

Diameter (mm)	Radius Tolerance	Diameter (mm)	Tolerance
D ≤ 25	±0.005	< 1	+0 -0.005
3 < D ≤ 6	±0.010	1 ≤ D ≤ 2.5	+0 -0.010
D > 6	±0.015	2.5 ≤ D ≤ 6	+0 -0.015
		6 < D ≤ 10	-0.005 -0.020
		> 10	-0.010 -0.025

Material Group | Material-Gruppe | Groupe Matiere | Gruppo Materiali | 材质主类

Cutting Parameter

N01	N02	N03	K01	K02	P01	P02	P03	M01	M02	S01	S02	S03	H01	H02	O01	O02	318
-----	-----	-----	-----	-----	-----	-----	-----	-----	-----	-----	-----	-----	-----	-----	-----	-----	-----

FEATURES & BENEFITS

DM70 (SE 70)



Top View - A5D



Top View - A5E

1 Gash Land Design



- Reinforce edge protection of the cutting tool corner
- Higher mechanical strength to withstand greater cutting force
- Greater process reliability and longer tool life

2 Suitable for Material

H





1. Stirnschliff Design
Verstärkung des Kantenschutzes der Schneidkanten.
Höhere mechanische Festigkeit, um größeren
Schnittkräften zu widerstehen.
konstante Bearbeitungszeit und höhere
Werkzeugstandzeit
 2. Geeignet für Materialgruppe H
-



1. 刃带设计
强化刃锋保护
应用于高强度切削时,提供更好的抗力
可延长加工时间并提高刀具的耐用性
 2. 适用于加工材料H
-



1. Disegno della scanalatura
Maggior protezione dell'elica del tagliente
Maggiore resistenza meccanica alla forza di taglio
Maggiore regolarità dei tempi di lavorazione
 2. Adatto per il materiale H
-



1. Conception de la terre d'entaille
Renforcer la protection des bords du coin de l'outil de
coupe
Résistance mécanique plus élevée pour résister à une
force de coupe plus importante
Une durée d'usinage plus longue et une plus grande
durabilité de l'outil
2. Adapté aux matériaux H

SE 70 MINIATURE ENDMILLS WITH LONG NECK, 2 FLUTES

- VHM SE 70 Kleinstfräser, mit langem Hals, 2 Zähne
- Micro-frese SE 70, con collo lungo, 2 taglianti
- Micro-fraises SE 70 avec cou long, 2 dents
- 整体硬质合金 SE 70 系列 微小径2刃长颈平底铣刀

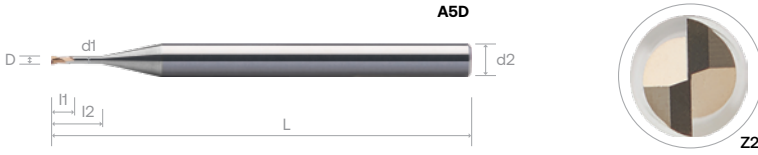

Order Number	Dimension (mm)						B0909+	Order Number	Dimension (mm)						B0909+
	D	l1	l2	L	d1	d2 (h5)			D	l1	l2	L	d1	d2 (h5)	
A5D 0010 050 0400	0.1	0.08	-	50	-	4	°	A5D 0060 050 0400 0500	0.6	0.5	5	50	0.56	4	°
A5D 0010 050 0400 0030			0.3	50	0.085	4	°	A5D 0060 050 0400 0600			6	50	0.56	4	•
A5D 0010 050 0400 0050			0.5	50	0.085	4	°	A5D 0060 050 0400 0800			8	50	0.56	4	°
A5D 0010 050 0400 0075			0.75	50	0.085	4	°	A5D 0070 050 0400			-	50	-	4	°
A5D 0010 050 0400 0100	0.15	0.12	1	50	0.085	4	°	A5D 0070 050 0400 0200	2	50	0.66	4	°		
A5D 0015 050 0400			-	50	-	4	°	A5D 0070 050 0400 0400	4	50	0.66	4	°		
A5D 0015 050 0400 0030			0.3	50	0.13	4	°	A5D 0070 050 0400 0600	6	50	0.66	4	°		
A5D 0015 050 0400 0050			0.5	50	0.13	4	°	A5D 0070 050 0400 0800	8	50	0.66	4	°		
A5D 0015 050 0400 0075	0.2	0.15	0.75	50	0.13	4	°	A5D 0070 050 0400 1000	10	50	0.66	4	°		
A5D 0015 050 0400 0100			1	50	0.13	4	°	A5D 0080 050 0400	-	50	-	4	°		
A5D 0015 050 0400 0150			1.5	50	0.13	4	°	A5D 0080 050 0400 0300	3	50	0.76	4	°		
A5D 0020 050 0400			-	50	-	4	°	A5D 0080 050 0400 0400	4	50	0.76	4	•		
A5D 0020 050 0400 0050	0.3	0.25	0.5	50	0.18	4	°	A5D 0080 050 0400 0500	5	50	0.76	4	°		
A5D 0020 050 0400 0075			0.75	50	0.18	4	°	A5D 0080 050 0400 0600	6	50	0.76	4	•		
A5D 0020 050 0400 0100			1	50	0.18	4	•	A5D 0080 050 0400 0800	8	50	0.76	4	°		
A5D 0020 050 0400 0150			1.5	50	0.18	4	°	A5D 0080 050 0400 1000	10	50	0.76	4	°		
A5D 0020 050 0400 0200	0.4	0.3	2	50	0.18	4	°	A5D 0080 050 0400 1200	12	50	0.76	4	°		
A5D 0020 050 0400 0250			2.5	50	0.18	4	°	A5D 0100 050 0400	-	50	-	4	°		
A5D 0020 050 0400 0300			3	50	0.18	4	°	A5D 0100 050 0400 0200	2	50	0.95	4	°		
A5D 0030 050 0400			-	50	-	4	°	A5D 0100 050 0400 0300	3	50	0.95	4	°		
A5D 0030 050 0400 0100	0.5	0.4	1	50	0.28	4	•	A5D 0100 050 0400 0400	4	50	0.95	4	°		
A5D 0030 050 0400 0150			1.5	50	0.28	4	•	A5D 0100 050 0400 0500	5	50	0.95	4	°		
A5D 0030 050 0400 0200			2	50	0.28	4	°	A5D 0100 050 0400 0600	6	50	0.95	4	•		
A5D 0030 050 0400 0250			2.5	50	0.28	4	°	A5D 0100 050 0400 0700	7	50	0.95	4	°		
A5D 0030 050 0400 0300	0.6	0.5	3	50	0.28	4	°	A5D 0100 050 0400 0800	8	50	0.95	4	•		
A5D 0040 050 0400			-	50	-	4	°	A5D 0100 050 0400 0900	9	50	0.95	4	°		
A5D 0040 050 0400 0100			1	50	0.37	4	°	A5D 0100 050 0400 1000	10	50	0.95	4	•		
A5D 0040 050 0400 0150			1.5	50	0.37	4	°	A5D 0100 050 0400 1200	12	50	0.95	4	•		
A5D 0040 050 0400 0200	0.7	0.6	2	50	0.37	4	•	A5D 0100 050 0400 1400	14	50	0.95	4	°		
A5D 0040 050 0400 0250			2.5	50	0.37	4	°	A5D 0100 050 0400 1600	16	50	0.95	4	•		
A5D 0040 050 0400 0300			3	50	0.37	4	°	A5D 0100 050 0400 1800	18	60	0.95	4	°		
A5D 0040 050 0400 0350			3.5	50	0.37	4	°	A5D 0100 050 0400 2000	20	60	0.95	4	°		
A5D 0040 050 0400 0400	0.8	0.7	4	50	0.37	4	•	A5D 0100 050 0400 2200	22	60	0.95	4	°		
A5D 0040 050 0400 0500			5	50	0.37	4	°	A5D 0120 050 0400	-	50	-	4	°		
A5D 0040 050 0400 0600			6	50	0.37	4	°	A5D 0120 050 0400 0600	6	50	1.15	4	•		
A5D 0040 050 0400 0800			8	50	0.37	4	°	A5D 0120 050 0400 0800	8	50	1.15	4	°		
A5D 0040 050 0400 1000	0.9	0.8	10	50	0.37	4	°	A5D 0120 050 0400 1000	10	50	1.15	4	°		
A5D 0050 050 0400			-	50	-	4	°	A5D 0120 050 0400 1200	12	50	1.15	4	°		
A5D 0050 050 0400 0100			1	50	0.46	4	°	A5D 0120 050 0400 1600	16	50	1.15	4	°		
A5D 0050 050 0400 0150			1.5	50	0.46	4	°	A5D 0140 050 0400	-	50	-	4	°		
A5D 0050 050 0400 0200	1.0	0.9	2	50	0.46	4	•	A5D 0140 050 0400 0600	6	50	1.35	4	°		
A5D 0050 050 0400 0250			2.5	50	0.46	4	°	A5D 0140 050 0400 1200	12	50	1.35	4	°		
A5D 0050 050 0400 0300			3	50	0.46	4	°	A5D 0150 050 0400	-	50	-	4	°		
A5D 0050 050 0400 0350			3.5	50	0.46	4	°	A5D 0150 050 0400 0400	4	50	1.45	4	°		
A5D 0050 050 0400 0400	1.2	1.0	4	50	0.46	4	•	A5D 0150 050 0400 0600	6	50	1.45	4	•		
A5D 0050 050 0400 0450			4.5	50	0.46	4	°	A5D 0150 050 0400 0800	8	50	1.45	4	•		
A5D 0050 050 0400 0500			5	50	0.46	4	°	A5D 0150 050 0400 1000	10	50	1.45	4	•		
A5D 0050 050 0400 0600			6	50	0.46	4	•	A5D 0150 050 0400 1200	12	50	1.45	4	•		
A5D 0050 050 0400 0700	1.4	1.1	7	50	0.46	4	°	A5D 0150 050 0400 1400	14	50	1.45	4	°		
A5D 0050 050 0400 0800			8	50	0.46	4	°	A5D 0150 050 0400 1600	16	50	1.45	4	°		
A5D 0050 050 0400 0900			9	50	0.46	4	°	A5D 0150 060 0400	-	60	-	4	°		
A5D 0050 050 0400 1000			10	50	0.46	4	°	A5D 0150 060 0400 1800	18	60	1.45	4	°		
A5D 0060 050 0400	1.5	1.2	-	50	-	4	°	A5D 0150 060 0400 2000	20	60	1.45	4	•		
A5D 0060 050 0400 0150			1.5	50	0.56	4	°	A5D 0150 075 0400	-	75	-	4	°		
A5D 0060 050 0400 0200			2	50	0.56	4	•	A5D 0150 075 0400 2500	25	75	1.45	4	°		
A5D 0060 050 0400 0300			3	50	0.56	4	°	A5D 0150 075 0400 3000	30	75	1.45	4	°		
A5D 0060 050 0400 0400	1.6	1.3	4	50	0.56	4	•	A5D 0150 075 0400 3500	35	75	1.45	4	°		

cont'd ▶

Diameter (mm)	Tolerance
< 1	+0 --0.005
1 ≤ D ≤ 2.5	+0 --0.010
2.5 ≤ D ≤ 6	+0 --0.015

Material Group | Material-Gruppe | Groupe Matiere | Gruppo Materiali | 材质主类

Cutting Parameter

N01	N02	N03	K01	K02	P01	P02	P03	M01	M02	S01	S02	S03	H01	H02	O01	O02	319 - 321
-----	-----	-----	-----	-----	-----	-----	-----	-----	-----	-----	-----	-----	-----	-----	-----	-----	-----------

SE 70 MINIATURE ENDMILLS WITH LONG NECK, 2 FLUTES

- VHM SE 70 Kleinstfräser, mit langem Hals, 2 Zähne
- Micro-frese SE 70, con collo lungo, 2 taglienti
- Micro-fraises SE 70 avec cou long, 2 dents
- 整体硬质合金 SE 70 系列 微小径2刃长颈平底铣刀

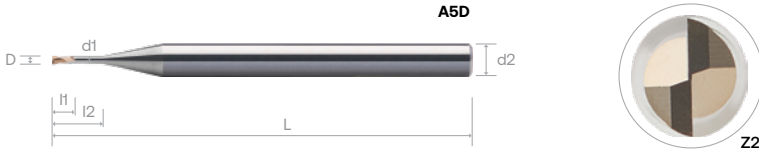

Order Number	Dimension (mm)						B0909+	Order Number	Dimension (mm)						B0909+	
	D	I1	I2	L	d1	d2 (h5)			D	I1	I2	L	d1	d2 (h5)		
A5D 0160 050 0400			-	50	-	4	o									
A5D 0160 050 0400 0600	1.6	1.3	6	50	1.55	4	o									
A5D 0160 050 0400 0800			8	50	1.55	4	o									
A5D 0180 050 0400			-	50	-	4	o									
A5D 0180 050 0400 0600			6	50	1.75	4	o									
A5D 0180 050 0400 0800			8	50	1.75	4	o									
A5D 0180 050 0400 1000			10	50	1.75	4	o									
A5D 0180 050 0400 1200	1.8	1.4	12	50	1.75	4	o									
A5D 0180 050 0400 1400			14	50	1.75	4	o									
A5D 0180 050 0400 1600			16	50	1.75	4	o									
A5D 0180 060 0400			-	60	-	4	o									
A5D 0180 060 0400 1800			18	60	1.75	4	o									
A5D 0200 050 0400			-	50	-	4	o									
A5D 0200 050 0400 0400			4	50	1.94	4	o									
A5D 0200 050 0400 0600	2	1.6	6	50	1.94	4	•									
A5D 0200 050 0400 0800			8	50	1.94	4	•									
A5D 0200 050 0400 1000			10	50	1.94	4	•									
A5D 0200 050 0400 1200			12	50	1.94	4	•									
A5D 0200 050 0400 1400			14	50	1.94	4	•									
A5D 0200 050 0400 1600			16	50	1.94	4	•									
A5D 0200 060 0400			-	60	-	4	o									
A5D 0200 060 0400 1800			18	60	1.94	4	o									
A5D 0200 060 0400 2000			20	60	1.94	4	•									
A5D 0200 075 0400	2	1.6	-	75	-	4	o									
A5D 0200 075 0400 2500			25	75	1.94	4	•									
A5D 0200 075 0400 3000			30	75	1.94	4	•									
A5D 0200 075 0400 3500			35	75	1.94	4	o									
A5D 0200 100 0400			-	100	-	4	o									
A5D 0200 100 0400 4000			40	100	1.94	4	o									
A5D 0200 100 0400 5000			50	100	1.94	4	o									
A5D 0250 050 0400			-	50	-	4	o									
A5D 0250 050 0400 0800			8	50	2.4	4	•									
A5D 0250 050 0400 1200			12	50	2.4	4	•									
A5D 0250 050 0400 1600			16	50	2.4	4	•									
A5D 0250 060 0400			-	60	-	4	o									
A5D 0250 060 0400 2000	2.5	2	20	60	2.4	4	•									
A5D 0250 075 0400			-	75	-	4	o									
A5D 0250 075 0400 3000			30	75	2.4	4	o									
A5D 0250 100 0400			-	100	-	4	o									
A5D 0250 100 0400 4000			40	100	2.4	4	o									
A5D 0250 100 0400 5000			50	100	2.4	4	o									
A5D 0300 050 0600			-	50	-	6	o									
A5D 0300 050 0600 0800			8	50	2.85	6	•									
A5D 0300 050 0600 1200			12	50	2.85	6	•									
A5D 0300 050 0600 1600			16	50	2.85	6	o									
A5D 0300 060 0600	3	4.5	-	60	-	6	o									
A5D 0300 060 0600 2000			20	60	2.85	6	•									
A5D 0300 075 0600			-	75	-	6	o									
A5D 0300 075 0600 2500			25	75	2.85	6	•									
A5D 0300 075 0600 3000			30	75	2.85	6	o									

Diameter (mm)	Tolerance
< 1	+0 --0.005
1 ≤ D ≤ 2.5	+0 --0.010
2.5 ≤ D ≤ 6	+0 --0.015

Material Group | Material-Gruppe | Groupe Matière | Gruppo Materiali | 材质主类

Cutting Parameter

N01	N02	N03	K01	K02	P01	P02	P03	M01	M02	S01	S02	S03	H01	H02	O01	O02	319 - 321
-----	-----	-----	-----	-----	-----	-----	-----	-----	-----	-----	-----	-----	-----	-----	-----	-----	-----------

SE 70 MINIATURE ENDMILLS WITH LONG NECK, 4 FLUTES

- VHM SE 70 Kleinstfräser, mit langem Hals, 4 Zähne
- Micro-frese SE 70, con collo lungo, 4 taglienti
- Micro-fraises SE 70 avec cou long, 4 dents
- 整体硬质合金 SE 70 系列 微小径4刃长颈平底铣刀

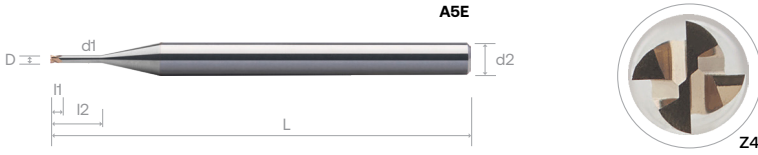

Order Number	Dimension (mm)						B0909+	Order Number	Dimension (mm)						B0909+
	D	I1	I2	L	d1	d2 (H5)			D	I1	I2	L	d1	d2 (H5)	
A5E 0100 050 0400	0.1	0.08	-	50	-	4	°	A5E 0400 075 0600 250	4	6	25	75	3.8	6	°
A5E 0100 050 0400 040			4	50	0.95	4	°	A5E 0400 075 0600 300			30	75	3.8	6	•
A5E 0100 050 0400 060			6	50	0.95	4	•	A5E 0400 075 0600 350			35	75	3.8	6	°
A5E 0100 050 0400 080			8	50	0.95	4	•	A5E 0400 100 0600			-	100	-	6	°
A5E 0100 050 0400 100	1.2	0.12	10	50	0.95	4	•	A5E 0400 100 0600 400	40	100	3.8	6	°		
A5E 0120 050 0400			-	50	-	4	°	A5E 0500 060 0600	-	60	-	6	°		
A5E 0120 050 0400 060			6	50	1.15	4	•	A5E 0500 060 0600 160	16	60	4.8	6	°		
A5E 0120 050 0400 080			8	50	1.15	4	°	A5E 0500 075 0600	-	75	-	6	°		
A5E 0120 050 0400 100	10	50	1.15	4	°	A5E 0500 075 0600 250	25	75	4.8	6	°				
A5E 0120 050 0400 120	12	50	1.15	4	°	A5E 0500 075 0600 350	35	75	4.8	6	°				
A5E 0150 050 0400	1.5	1.2	-	50	-	4	°	A5E 0500 100 0600	-	100	-	6	°		
A5E 0150 050 0400 060			6	50	1.45	4	•	A5E 0500 100 0600 500	50	100	4.8	6	°		
A5E 0150 050 0400 080			8	50	1.45	4	•	A5E 0600 060 0600	-	60	-	6	°		
A5E 0150 050 0400 100			10	50	1.45	4	•	A5E 0600 060 0600 200	20	60	5.8	6	°		
A5E 0150 050 0400 120	12	50	1.45	4	•	A5E 0600 075 0600	-	75	-	6	°				
A5E 0150 050 0400 140	14	50	1.45	4	°	A5E 0600 075 0600 300	30	75	5.8	6	°				
A5E 0150 050 0400 160	16	50	1.45	4	•	A5E 0600 100 0600	-	100	-	6	°				
A5E 0180 050 0400	1.8	1.4	-	50	-	4	°	A5E 0600 100 0600 400	40	100	5.8	6	°		
A5E 0180 050 0400 060			6	50	1.74	4	°	A5E 0600 100 0600 500	50	100	5.8	6	°		
A5E 0180 050 0400 080			8	50	1.74	4	°								
A5E 0180 050 0400 100			10	50	1.74	4	°								
A5E 0180 050 0400 120	12	50	1.74	4	°										
A5E 0180 050 0400 140	14	50	1.74	4	°										
A5E 0180 050 0400 160	16	50	1.74	4	°										
A5E 0180 050 0400 180	18	60	1.74	4	°										
A5E 0200 050 0400	2	1.6	-	50	-	4	°								
A5E 0200 050 0400 060			6	50	1.94	4	•								
A5E 0200 050 0400 080			8	50	1.94	4	•								
A5E 0200 050 0400 100			10	50	1.94	4	•								
A5E 0200 050 0400 120	12	50	1.94	4	•										
A5E 0200 050 0400 140	14	50	1.94	4	•										
A5E 0200 050 0400 160	16	50	1.94	4	•										
A5E 0200 050 0400 180	18	60	1.94	4	°										
A5E 0200 050 0400 200	20	60	1.94	4	°										
A5E 0250 050 0400	2.5	2	-	50	-	4	°								
A5E 0250 050 0400 080			8	50	2.4	4	•								
A5E 0250 050 0400 120			12	50	2.4	4	•								
A5E 0250 050 0400 160			16	50	2.4	4	•								
A5E 0250 060 0400	-	60	-	4	°										
A5E 0250 060 0400 200	20	60	2.4	4	•										
A5E 0250 075 0400	-	75	-	4	°										
A5E 0250 075 0400 250	25	75	2.4	4	°										
A5E 0300 050 0600	3	4.5	-	50	-	6	°								
A5E 0300 050 0600 080			8	50	2.85	6	•								
A5E 0300 050 0600 120			12	50	2.85	6	•								
A5E 0300 060 0600			-	60	-	6	°								
A5E 0300 060 0600 160	16	60	2.85	6	•										
A5E 0300 060 0600 200	20	60	2.85	6	•										
A5E 0300 075 0600	-	75	-	6	°										
A5E 0300 075 0600 250	25	75	2.85	6	•										
A5E 0300 075 0600 300	30	75	2.85	6	°										
A5E 0400 050 0600	4	6	-	50	-	6	°								
A5E 0400 050 0600 120			12	50	3.8	6	°								
A5E 0400 060 0600			-	60	-	6	°								
A5E 0400 060 0600 160			16	60	3.8	6	°								
A5E 0400 060 0600 200	20	60	3.8	6	°										
A5E 0400 075 0600	-	75	-	6	°										

Diameter (mm)	Tolerance
< 1	+0 --0.005
1 ≤ D ≤ 2.5	+0 --0.010
2.5 ≤ D ≤ 6	+0 --0.015

Material Group | Material-Gruppe | Groupe Matiere | Gruppo Materiali | 材质主类

Cutting Parameter

N01 N02 N03 K01 K02 P01 P02 P03 M01 M02 S01 S02 S03 H01 H02 O01 O02
322 - 323

ALL LINE
 EZ LINE -
 ENDMILL
 SE 30
 NITCO 30
 OPTIMUM
 SE 45
 SE 45X
 NITCO 45
 SE 60
 SE 60X
 DM70 -
 SE 70
 SE GR
 TE 45
 PLUNGE
 MILL
 THREAD
 MILL

FEATURES & BENEFITS

DM70 (SE 70R)



Top View - Z2



Top View - Z4

1 S-Gash Radius Design



- Perfect joining between corner radius and outer diameter to achieve higher accuracy radius contour
- More reliability corner radius with lower risk of chipping
- Better surface finishing quality
- Stronger corner radius design to increase tool life
- More quiet during machining and good to production machinist well-being

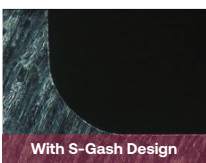

With S-Gash Design

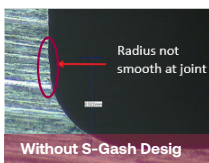

Without S-Gash Desig

2 Enhanced Tool Rigidity

- Higher stability to reduce vibration
- Enhanced tool life and productivity
- Higher process reliability and dimension accuracy

3 Suitable for Material

H





1. S-Gash-Radius Geometrie
perfekte Übergänge zwischen Eckenradius und Außendurchmesser für eine höhere Genauigkeit der Radiuskontur
zuverlässigerer Eckenradius mit geringerem Risiko von Ausbrüchen
bessere Oberflächengüte bei der Bearbeitung von Bauteilen
verstärkte Eckenradien zur Erhöhung der Werkzeugstandzeit
ruhiger bei der Bearbeitung und gut für das Wohlbefinden des Produktionsmechanikers.
2. verbesserte Werkzeugstabilität
höhere Stabilität zur Reduzierung von Vibrationen
verbesserte Werkzeugstandzeit und Produktivität der Werkzeuge
höhere Prozesssicherheit und Maßgenauigkeit
3. Geeignet für Materialgruppe H



1. 刃带弧度设计
圆角半径与外径之间的完美连接, 以实现更高精度的半径轮廓
更可靠的圆弧可降低崩损风险
具有更好的加工部件表面精加工质量
更强的圆角半径设计以延长刀具寿命
可降低加工过程中的噪音, 有利于作业人员的健康
2. 增强刀具的刚性
具有更高的稳定性可减少震动
延长刀具寿命和提高其生产率性能
提高加工过程的可靠性和刀具尺寸的精确度
3. 适用于加工材料H



1. Disegno del profilo della scanalatura
Raccordo ideale tra il profilo interno e il diametro esterno
Minor rischio di scheggiatura
Migliore qualità di finitura superficiale
Maggior durata dell'utensile
Lavorazione piu' dolce
2. Maggiore rigidità dell'utensile
Maggiore stabilità e vibrazioni ridotte
Migliora la durata dell'utensile e la produttività
Migliore precisione dimensionale
3. Adatto per il materiale H



1. Conception de rayon S-Gash
Jointure parfaite entre le rayon d'angle et le diamètre extérieur pour obtenir un contour de rayon plus précis
Rayon d'angle plus fiable avec moins de risque d'écaillage
Meilleure qualité de finition de surface sur le composant d'usinage
Conception de rayon de coin plus fort pour augmenter la durée de vie de l'outil
Plus silencieux pendant l'usinage et bon pour le bien-être des machinistes de production
2. Rigidité de l'outil améliorée
Une plus grande stabilité pour réduire les vibrations et Améliorez la durée de vie de l'outil et les performances de productivité
Fiabilité de processus plus élevée et précision des dimensions plus élevée
3. Adapté aux matériaux H

SE 70R MINIATURE TORUS ENDMILLS WITH LONG NECK, 2 FLUTES

- VHM SE 70R Torus-Kleinstfräser mit langem Hals, 2 Zähne
- Micro-frese torodali SE 70R, con collo lungo, 2 taglienti
- Micro-fraises SE 70R toriques avec cou long, 2 dents
- 整体硬质合金 SE 70R 系列 微小径2刃长颈圆鼻铣刀

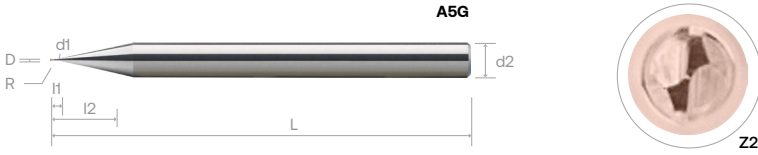

Order Number	Dimension (mm)								B0909+	Order Number	Dimension (mm)								B0909+
	D	I1	I2	L	d1	R	d2(f15)	Z			D	I1	I2	L	d1	R	d2(f15)	Z	
A5G 0020 050 0400 R002	0.2	0.15	-	50	-	0.02	4	2	°	A5G 0050 050 0400 030 R010	0.5	0.4	3.0	50	0.46	0.1	4	2	°
A5G 0020 050 0400 005 R002			0.5	50	0.18	0.02	4	2	°	A5G 0050 050 0400 040 R010			4.0	50	0.46	0.1	4	2	°
A5G 0020 050 0400 010 R002			1.0	50	0.18	0.02	4	2	°	A5G 0050 050 0400 050 R010			5.0	50	0.46	0.1	4	2	°
A5G 0020 050 0400 015 R002			1.5	50	0.18	0.02	4	2	°	A5G 0050 050 0400 060 R010			6.0	50	0.46	0.1	4	2	°
A5G 0020 050 0400 020 R002			2.0	50	0.18	0.02	4	2	°	A5G 0060 050 0400 R002			-	50	-	0.02	4	2	°
A5G 0020 050 0400 R005			-	50	-	0.05	4	2	°	A5G 0060 050 0400 020 R002			2.0	50	0.56	0.02	4	2	°
A5G 0020 050 0400 005 R005			0.5	50	0.18	0.05	4	2	°	A5G 0060 050 0400 040 R002			4.0	50	0.56	0.02	4	2	°
A5G 0020 050 0400 010 R005			1.0	50	0.18	0.05	4	2	°	A5G 0060 050 0400 060 R002			6.0	50	0.56	0.02	4	2	°
A5G 0020 050 0400 015 R005			1.5	50	0.18	0.05	4	2	°	A5G 0060 050 0400 080 R002			8.0	50	0.56	0.02	4	2	°
A5G 0020 050 0400 020 R005			2.0	50	0.18	0.05	4	2	°	A5G 0060 050 0400 100 R002			10.0	50	0.56	0.02	4	2	°
A5G 0030 050 0400 R002	0.3	0.25	-	50	-	0.02	4	2	°	A5G 0060 050 0400 R005	-	50	-	0.05	4	2	°		
A5G 0030 050 0400 010 R002			1.0	50	0.28	0.02	4	2	°	A5G 0060 050 0400 020 R005	2.0	50	0.56	0.05	4	2	°		
A5G 0030 050 0400 015 R002			1.5	50	0.28	0.02	4	2	°	A5G 0060 050 0400 040 R005	4.0	50	0.56	0.05	4	2	°		
A5G 0030 050 0400 020 R002			2.0	50	0.28	0.02	4	2	°	A5G 0060 050 0400 060 R005	6.0	50	0.56	0.05	4	2	°		
A5G 0030 050 0400 025 R002			2.5	50	0.28	0.02	4	2	°	A5G 0060 050 0400 080 R005	8.0	50	0.56	0.05	4	2	°		
A5G 0030 050 0400 030 R002			3.0	50	0.28	0.02	4	2	°	A5G 0060 050 0400 100 R005	10.0	50	0.56	0.05	4	2	°		
A5G 0030 050 0400 R005			-	50	-	0.05	4	2	°	A5G 0060 050 0400 R010	-	50	-	0.1	4	2	°		
A5G 0030 050 0400 010 R005			1.0	50	0.28	0.05	4	2	°	A5G 0070 050 0400 020 R010	2.0	50	0.56	0.1	4	2	°		
A5G 0030 050 0400 015 R005			1.5	50	0.28	0.05	4	2	°	A5G 0060 050 0400 040 R010	4.0	50	0.56	0.1	4	2	°		
A5G 0030 050 0400 020 R005			2.0	50	0.28	0.05	4	2	°	A5G 0060 050 0400 060 R010	6.0	50	0.56	0.1	4	2	°		
A5G 0030 050 0400 025 R005	2.5	50	0.28	0.05	4	2	°	A5G 0060 050 0400 080 R010	8.0	50	0.56	0.1	4	2	°				
A5G 0030 050 0400 030 R005	3.0	50	0.28	0.05	4	2	°	A5G 0060 050 0400 100 R010	10.0	50	0.56	0.1	4	2	°				
A5G 0040 050 0400 R002	0.4	0.3	-	50	-	0.02	4	2	°	A5G 0070 050 0400 R002	-	50	-	0.02	4	2	°		
A5G 0040 050 0400 010 R002			1.0	50	0.37	0.02	4	2	°	A5G 0070 050 0400 020 R002	2.0	50	0.66	0.02	4	2	°		
A5G 0040 050 0400 015 R002			1.5	50	0.37	0.02	4	2	°	A5G 0070 050 0400 040 R002	4.0	50	0.66	0.02	4	2	°		
A5G 0040 050 0400 020 R002			2.0	50	0.37	0.02	4	2	°	A5G 0070 050 0400 060 R002	6.0	50	0.66	0.02	4	2	°		
A5G 0040 050 0400 025 R002			2.5	50	0.37	0.02	4	2	°	A5G 0070 050 0400 R005	-	50	0.66	0.05	4	2	°		
A5G 0040 050 0400 030 R002			3.0	50	0.37	0.02	4	2	°	A5G 0070 050 0400 020 R005	2.0	50	0.66	0.05	4	2	°		
A5G 0040 050 0400 040 R002			4.0	50	0.37	0.02	4	2	°	A5G 0070 050 0400 040 R005	4.0	50	0.66	0.05	4	2	°		
A5G 0040 050 0400 R005			-	50	-	0.05	4	2	°	A5G 0070 050 0400 060 R005	6.0	50	0.66	0.05	4	2	°		
A5G 0040 050 0400 010 R005			1.0	50	0.37	0.05	4	2	°	A5G 0070 050 0400 R010	-	50	0.66	0.1	4	2	°		
A5G 0040 050 0400 015 R005			1.5	50	0.37	0.05	4	2	°	A5G 0070 050 0400 020 R010	2.0	50	0.66	0.1	4	2	°		
A5G 0040 050 0400 020 R005	2.0	50	0.37	0.05	4	2	°	A5G 0070 050 0400 040 R010	4.0	50	0.66	0.1	4	2	°				
A5G 0040 050 0400 025 R005	2.5	50	0.37	0.05	4	2	°	A5G 0070 050 0400 060 R010	6.0	50	0.66	0.1	4	2	°				
A5G 0040 050 0400 030 R005	3.0	50	0.37	0.05	4	2	°	A5G 0080 050 0400 R002	-	50	-	0.02	4	2	°				
A5G 0040 050 0400 040 R005	4.0	50	0.37	0.05	4	2	°	A5G 0080 050 0400 020 R002	2.0	50	0.76	0.02	4	2	°				
A5G 0040 050 0400 R010	-	50	-	0.1	4	2	°	A5G 0080 050 0400 040 R002	4.0	50	0.76	0.02	4	2	°				
A5G 0040 050 0400 010 R010	1.0	50	0.37	0.1	4	2	°	A5G 0080 050 0400 060 R002	6.0	50	0.76	0.02	4	2	°				
A5G 0040 050 0400 015 R010	1.5	50	0.37	0.1	4	2	°	A5G 0080 050 0400 080 R002	8.0	50	0.76	0.02	4	2	°				
A5G 0040 050 0400 020 R010	2.0	50	0.37	0.1	4	2	°	A5G 0080 050 0400 R005	-	50	-	0.05	4	2	°				
A5G 0040 050 0400 025 R010	2.5	50	0.37	0.1	4	2	°	A5G 0080 050 0400 020 R005	2.0	50	0.76	0.05	4	2	°				
A5G 0040 050 0400 030 R010	3.0	50	0.37	0.1	4	2	°	A5G 0080 050 0400 040 R005	4.0	50	0.76	0.05	4	2	°				
A5G 0040 050 0400 040 R010	4.0	50	0.37	0.1	4	2	°	A5G 0080 050 0400 060 R005	6.0	50	0.76	0.05	4	2	°				
A5G 0050 050 0400 R002	0.5	0.4	-	50	-	0.02	4	2	°	A5G 0080 050 0400 080 R005	8.0	50	0.76	0.05	4	2	°		
A5G 0050 050 0400 010 R002			1.0	50	0.46	0.02	4	2	°	A5G 0080 050 0400 120 R005	12.0	50	0.76	0.05	4	2	°		
A5G 0050 050 0400 020 R002			2.0	50	0.46	0.02	4	2	°	A5G 0080 050 0400 R010	-	50	-	0.1	4	2	°		
A5G 0050 050 0400 030 R002			3.0	50	0.46	0.02	4	2	°	A5G 0080 050 0400 020 R010	2.0	50	0.76	0.1	4	2	°		
A5G 0050 050 0400 040 R002			4.0	50	0.46	0.02	4	2	°	A5G 0080 050 0400 040 R010	4.0	50	0.76	0.1	4	2	°		
A5G 0050 050 0400 050 R002			5.0	50	0.46	0.02	4	2	°	A5G 0080 050 0400 060 R010	6.0	50	0.76	0.1	4	2	°		
A5G 0050 050 0400 060 R002			6.0	50	0.46	0.02	4	2	°	A5G 0080 050 0400 080 R010	8.0	50	0.76	0.1	4	2	°		
A5G 0050 050 0400 R005			-	50	-	0.05	4	2	°	A5G 0080 050 0400 120 R010	12.0	50	0.76	0.1	4	2	°		
A5G 0050 050 0400 010 R005			1.0	50	0.46	0.05	4	2	°	A5G 0080 050 0400 R020	-	50	-	0.2	4	2	°		
A5G 0050 050 0400 020 R005			2.0	50	0.46	0.05	4	2	°	A5G 0080 050 0400 020 R020	2.0	50	0.76	0.2	4	2	°		
A5G 0050 050 0400 030 R005	3.0	50	0.46	0.05	4	2	°	A5G 0080 050 0400 040 R020	4.0	50	0.76	0.2	4	2	°				
A5G 0050 050 0400 040 R005	4.0	50	0.46	0.05	4	2	°	A5G 0080 050 0400 060 R020	6.0	50	0.76	0.2	4	2	°				
A5G 0050 050 0400 050 R005	5.0	50	0.46	0.05	4	2	°	A5G 0080 050 0400 080 R020	8.0	50	0.76	0.2	4	2	°				
A5G 0050 050 0400 060 R005	6.0	50	0.46	0.05	4	2	°	A5G 0080 050 0400 120 R020	12.0	50	0.76	0.2	4	2	°				
A5G 0050 050 0400 R010	-	50	-	0.1	4	2	°	A5G 0090 050 0400 R010	-	50	-	0.1	4	2	°				
A5G 0050 050 0400 010 R010	1.0	50	0.46	0.1	4	2	°	A5G 0090 050 0400 040 R010	4.0	50	0.85	0.1	4	2	°				
A5G 0050 050 0400 020 R010	2.0	50	0.46	0.1	4	2	°	A5G 0090 050 0400 080 R010	8.0	50	0.85	0.1	4	2	°				

Diameter (mm)	Radius Tolerance	Diameter (mm)	Tolerance
D ≤ 2.5	±0.005	< 1	+0 --0.005
		1 ≤ D ≤ 2.5	+0 --0.010

Material Group | Material-Gruppe | Groupe Matière | Gruppo Materiali | 材质主类

Cutting Parameter

N01	N02	N03	K01	K02	P01	P02	P03	M01	M02	S01	S02	S03	H01	H02	O01	O02	323 - 324
-----	-----	-----	-----	-----	-----	-----	-----	-----	-----	-----	-----	-----	-----	-----	-----	-----	-----------

SE 70R MINIATURE TORUS ENDMILLS WITH LONG NECK, 4 FLUTES

- VHM SE 70R Torus-Kleinstfräser mit langem Hals, 4 Zähne
- Micro-frese torodali SE 70R, con collo lungo, 4 taglienti
- Micro-fraises SE 70R toriques avec cou long, 4 dents
- 整体硬质合金 SE 70R 系列 微小径4刃长颈圆鼻铣刀

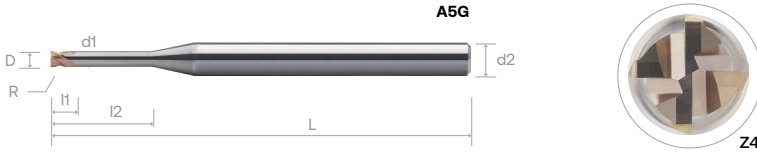

Order Number	Dimension (mm)								B0909+	Order Number	Dimension (mm)								B0909+	
	D	I1	I2	L	d1	R	d2(h5)	Z			D	I1	I2	L	d1	R	d2(h5)	Z		
A5G 0100 050 0400 R002				-	50	-	0.02	4	4	°	A5G 0150 050 0400 030 R005			3.0	50	1.43	0.05	4	4	°
A5G 0100 050 0400 020 R002				2.0	50	0.95	0.02	4	4	°	A5G 0150 050 0400 040 R005			4.0	50	1.43	0.05	4	4	°
A5G 0100 050 0400 030 R002				3.0	50	0.95	0.02	4	4	°	A5G 0150 050 0400 060 R005			6.0	50	1.43	0.05	4	4	°
A5G 0100 050 0400 040 R002				4.0	50	0.95	0.02	4	4	°	A5G 0150 050 0400 080 R005			8.0	50	1.43	0.05	4	4	°
A5G 0100 050 0400 050 R002				5.0	50	0.95	0.02	4	4	°	A5G 0150 050 0400 120 R005			12.0	50	1.43	0.05	4	4	°
A5G 0100 050 0400 060 R002				6.0	50	0.95	0.02	4	4	°	A5G 0150 050 0400 150 R005			15.0	50	1.43	0.05	4	4	°
A5G 0100 050 0400 080 R002				8.0	50	0.95	0.02	4	4	°	A5G 0150 050 0400 R010			-	50	-	0.1	4	4	°
A5G 0100 050 0400 100 R002				10.0	50	0.95	0.02	4	4	°	A5G 0150 050 0400 030 R010			3.0	50	1.43	0.1	4	4	°
A5G 0100 050 0400 R005				-	50	-	0.05	4	4	°	A5G 0150 050 0400 040 R010			4.0	50	1.43	0.1	4	4	°
A5G 0100 050 0400 020 R005				2.0	50	0.95	0.05	4	4	°	A5G 0150 050 0400 060 R010			6.0	50	1.43	0.1	4	4	°
A5G 0100 050 0400 030 R005				3.0	50	0.95	0.05	4	4	°	A5G 0150 050 0400 080 R010			8.0	50	1.43	0.1	4	4	°
A5G 0100 050 0400 040 R005				4.0	50	0.95	0.05	4	4	°	A5G 0150 050 0400 120 R010			12.0	50	1.43	0.1	4	4	°
A5G 0100 050 0400 050 R005				5.0	50	0.95	0.05	4	4	°	A5G 0150 050 0400 150 R010			15.0	50	1.43	0.1	4	4	°
A5G 0100 050 0400 060 R005				6.0	50	0.95	0.05	4	4	°	A5G 0150 050 0400 R020			-	50	-	0.2	4	4	°
A5G 0100 050 0400 080 R005				8.0	50	0.95	0.05	4	4	°	A5G 0150 050 0400 030 R020			3.0	50	1.43	0.2	4	4	°
A5G 0100 050 0400 100 R005				10.0	50	0.95	0.05	4	4	°	A5G 0150 050 0400 040 R020			4.0	50	1.43	0.2	4	4	°
A5G 0100 050 0400 R010				-	50	-	0.1	4	4	°	A5G 0150 050 0400 060 R020			6.0	50	1.43	0.2	4	4	°
A5G 0100 050 0400 020 R010				2.0	50	0.95	0.1	4	4	°	A5G 0150 050 0400 080 R020			8.0	50	1.43	0.2	4	4	°
A5G 0100 050 0400 030 R010				3.0	50	0.95	0.1	4	4	°	A5G 0150 050 0400 100 R020			10.0	50	1.43	0.2	4	4	°
A5G 0100 050 0400 040 R010				4.0	50	0.95	0.1	4	4	°	A5G 0150 050 0400 120 R020			12.0	50	1.43	0.2	4	4	°
A5G 0100 050 0400 050 R010				5.0	50	0.95	0.1	4	4	°	A5G 0150 050 0400 150 R020			15.0	50	1.43	0.2	4	4	°
A5G 0100 050 0400 060 R010				6.0	50	0.95	0.1	4	4	°	A5G 0150 050 0400 R030			-	50	-	0.3	4	4	°
A5G 0100 050 0400 080 R010				8.0	50	0.95	0.1	4	4	°	A5G 0150 050 0400 030 R030			3.0	50	1.43	0.3	4	4	°
A5G 0100 050 0400 100 R010				10.0	50	0.95	0.1	4	4	°	A5G 0150 050 0400 040 R030			4.0	50	1.43	0.3	4	4	°
A5G 0100 050 0400 R020				-	50	-	0.2	4	4	°	A5G 0150 050 0400 060 R030			6.0	50	1.43	0.3	4	4	°
A5G 0100 050 0400 020 R020				2.0	50	0.95	0.2	4	4	°	A5G 0150 050 0400 080 R030			8.0	50	1.43	0.3	4	4	°
A5G 0100 050 0400 030 R020				3.0	50	0.95	0.2	4	4	°	A5G 0150 050 0400 120 R030			12.0	50	1.43	0.3	4	4	°
A5G 0100 050 0400 040 R020				4.0	50	0.95	0.2	4	4	°	A5G 0150 050 0400 150 R030			15.0	50	1.43	0.3	4	4	°
A5G 0100 050 0400 050 R020				5.0	50	0.95	0.2	4	4	°	A5G 0150 050 0400 R050			-	50	-	0.5	4	4	°
A5G 0100 050 0400 060 R020				6.0	50	0.95	0.2	4	4	°	A5G 0150 050 0400 030 R050			3.0	50	1.43	0.5	4	4	°
A5G 0100 050 0400 080 R020				8.0	50	0.95	0.2	4	4	°	A5G 0150 050 0400 040 R050			4.0	50	1.43	0.5	4	4	°
A5G 0100 050 0400 100 R020				10.0	50	0.95	0.2	4	4	°	A5G 0150 050 0400 060 R050			6.0	50	1.43	0.5	4	4	°
A5G 0100 050 0400 120 R020				12.0	50	0.95	0.2	4	4	°	A5G 0150 050 0400 080 R050			8.0	50	1.43	0.5	4	4	°
A5G 0100 050 0400 R030				-	50	-	0.3	4	4	°	A5G 0150 050 0400 120 R050			12.0	50	1.43	0.5	4	4	°
A5G 0100 050 0400 020 R030				2.0	50	0.95	0.3	4	4	°	A5G 0150 050 0400 150 R050			15.0	50	1.43	0.5	4	4	°
A5G 0100 050 0400 030 R030				3.0	50	0.95	0.3	4	4	°	A5G 0200 050 0400 R002			-	50	-	0.02	4	4	°
A5G 0100 050 0400 040 R030				4.0	50	0.95	0.3	4	4	°	A5G 0200 050 0400 040 R002			4.0	50	1.91	0.02	4	4	°
A5G 0100 050 0400 050 R030				5.0	50	0.95	0.3	4	4	°	A5G 0200 050 0400 060 R002			6.0	50	1.91	0.02	4	4	°
A5G 0100 050 0400 060 R030				6.0	50	0.95	0.3	4	4	°	A5G 0200 050 0400 080 R002			8.0	50	1.91	0.02	4	4	°
A5G 0100 050 0400 080 R030				8.0	50	0.95	0.3	4	4	°	A5G 0200 050 0400 120 R002			12.0	50	1.91	0.02	4	4	°
A5G 0100 050 0400 100 R030				10.0	50	0.95	0.3	4	4	°	A5G 0200 050 0400 R002			-	60	-	0.02	4	4	°
A5G 0120 050 0400 R010				-	50	-	0.1	4	4	°	A5G 0200 060 0400 160 R002			16.0	60	1.91	0.02	4	4	°
A5G 0120 050 0400 050 R010				5.0	50	1.14	0.1	4	4	°	A5G 0200 060 0400 200 R002			20.0	60	1.91	0.02	4	4	°
A5G 0120 050 0400 100 R010				10.0	50	1.14	0.1	4	4	°	A5G 0200 050 0400 R005			-	50	-	0.05	4	4	°
A5G 0120 050 0400 R020				-	50	-	0.2	4	4	°	A5G 0200 050 0400 040 R005			4.0	50	1.91	0.05	4	4	°
A5G 0120 050 0400 050 R020				5.0	50	1.14	0.2	4	4	°	A5G 0200 050 0400 060 R005			6.0	50	1.91	0.05	4	4	°
A5G 0120 050 0400 100 R020				10.0	50	1.14	0.2	4	4	°	A5G 0200 050 0400 080 R005			8.0	50	1.91	0.05	4	4	°
A5G 0120 050 0400 R030				-	50	-	0.3	4	4	°	A5G 0200 050 0400 120 R005			12.0	50	1.91	0.05	4	4	°
A5G 0120 050 0400 050 R030				5.0	50	1.14	0.3	4	4	°	A5G 0200 060 0400 R005			-	60	-	0.05	4	4	°
A5G 0120 050 0400 100 R030				10.0	50	1.14	0.3	4	4	°	A5G 0200 060 0400 160 R005			16.0	60	1.91	0.05	4	4	°
A5G 0150 050 0400 R002				-	50	-	0.02	4	4	°	A5G 0200 060 0400 200 R005			20.0	60	1.91	0.05	4	4	°
A5G 0150 050 0400 030 R002				3.0	50	1.43	0.02	4	4	°	A5G 0200 050 0400 R010			-	50	-	0.1	4	4	°
A5G 0150 050 0400 040 R002				4.0	50	1.43	0.02	4	4	°	A5G 0200 050 0400 040 R010			4.0	50	1.91	0.1	4	4	°
A5G 0150 050 0400 060 R002				6.0	50	1.43	0.02	4	4	°	A5G 0200 050 0400 060 R010			6.0	50	1.91	0.1	4	4	°
A5G 0150 050 0400 080 R002				8.0	50	1.43	0.02	4	4	°	A5G 0200 050 0400 080 R010			8.0	50	1.91	0.1	4	4	°
A5G 0150 050 0400 120 R002				12.0	50	1.43	0.02	4	4	°	A5G 0200 050 0400 120 R010			12.0	50	1.91	0.1	4	4	°
A5G 0150 050 0400 150 R002				15.0	50	1.43	0.02	4	4	°	A5G 0200 060 0400 R010			-	60	-	0.1	4	4	°
A5G 0150 050 0400 R005				-	50	-	0.05	4	4	°	A5G 0200 060 0400 160 R010			16.0	60	1.91	0.1	4	4	°

cont'd ▶

Diameter (mm)	Radius Tolerance	Diameter (mm)	Tolerance
D ≤ 2.5	±0.005	< 1	+0 -0.005
3 < D ≤ 6	±0.010	1 ≤ D ≤ 2.5	+0 -0.010
D > 6	±0.015	2.5 ≤ D ≤ 6	+0 -0.015

Material Group | Material-Gruppe | Groupe Matiere | Gruppo Materiali | 材质主类

Cutting Parameter

N01 N02 N03 K01 K02 P01 P02 P03 M01 M02 S01 S02 S03 H01 H02 O01 O02 324 - 325

SE 70R MINIATURE TORUS ENDMILLS WITH LONG NECK, 4 FLUTES

- VHM SE 70R Torus-Kleinstfräser mit langem Hals, 4 Zähne
- Micro-frese torodali SE 70R, con collo lungo, 4 taglianti
- Micro-fraises SE 70R toriques avec cou long, 4 dents
- 整体硬质合金 SE 70R 系列 微小径4刃长颈圆鼻铣刀

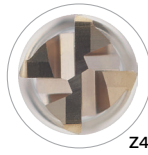

Order Number	Dimension (mm)									B0909+	Order Number	Dimension (mm)									B0909+
	D	I1	I2	L	d1	R	d2(r15)	Z				D	I1	I2	L	d1	R	d2(r15)	Z		
A5G 0200 060 0400 200 R010	2	1.6	20.0	60	1.91	0.1	4	4	°	A5G 0300 050 0600 R010	3	2.5	-	50	-	0.1	6	4	°		
A5G 0200 050 0400 R020			-	50	-	0.2	4	4	°	A5G 0300 050 0600 040 R010			4.0	50	2.85	0.1	6	4	°		
A5G 0200 050 0400 040 R020			4.0	50	1.91	0.2	4	4	°	A5G 0300 050 0600 060 R010			6.0	50	2.85	0.1	6	4	°		
A5G 0200 050 0400 060 R020			6.0	50	1.91	0.2	4	4	°	A5G 0300 050 0600 080 R010			8.0	50	2.85	0.1	6	4	°		
A5G 0200 050 0400 080 R020			8.0	50	1.91	0.2	4	4	°	A5G 0300 050 0600 100 R010			10.0	50	2.85	0.1	6	4	°		
A5G 0200 050 0400 100 R020			10.0	50	1.91	0.2	4	4	°	A5G 0300 050 0600 120 R010			12.0	50	2.85	0.1	6	4	°		
A5G 0200 050 0400 120 R020			12.0	50	1.91	0.2	4	4	°	A5G 0300 060 0600 R010			-	60	-	0.1	6	4	°		
A5G 0200 060 0400 R020			-	60	-	0.2	4	4	°	A5G 0300 060 0600 160 R010			16.0	60	2.85	0.1	6	4	°		
A5G 0200 060 0400 160 R020			16.0	60	1.91	0.2	4	4	°	A5G 0300 060 0600 200 R010			20.0	60	2.85	0.1	6	4	°		
A5G 0200 060 0400 200 R020			20.0	60	1.91	0.2	4	4	°	A5G 0300 075 0600 R010			-	75	-	0.1	6	4	°		
A5G 0200 050 0400 R030			-	50	-	0.3	4	4	°	A5G 0300 075 0600 250 R010			25.0	75	2.85	0.1	6	4	°		
A5G 0200 050 0400 040 R030			4.0	50	1.91	0.3	4	4	°	A5G 0300 075 0600 300 R010			30.0	75	2.85	0.1	6	4	°		
A5G 0200 050 0400 060 R030			6.0	50	1.91	0.3	4	4	°	A5G 0300 050 0600 R020			-	50	-	0.2	6	4	°		
A5G 0200 050 0400 080 R030			8.0	50	1.91	0.3	4	4	°	A5G 0300 050 0600 040 R020			4.0	50	2.85	0.2	6	4	°		
A5G 0200 050 0400 120 R030			12.0	50	1.91	0.3	4	4	°	A5G 0300 050 0600 060 R020			6.0	50	2.85	0.2	6	4	°		
A5G 0200 060 0400 R030			-	60	-	0.3	4	4	°	A5G 0300 050 0600 080 R020			8.0	50	2.85	0.2	6	4	°		
A5G 0200 060 0400 160 R030			16.0	60	1.91	0.3	4	4	°	A5G 0300 050 0600 100 R020			10.0	50	2.85	0.2	6	4	°		
A5G 0200 060 0400 200 R030			20.0	60	1.91	0.3	4	4	°	A5G 0300 050 0600 120 R020			12.0	50	2.85	0.2	6	4	°		
A5G 0200 050 0400 R050			-	50	-	0.5	4	4	°	A5G 0300 060 0600 R020			-	60	-	0.2	6	4	°		
A5G 0200 050 0400 040 R050			4.0	50	1.91	0.5	4	4	°	A5G 0300 060 0600 160 R020			16.0	60	2.85	0.2	6	4	°		
A5G 0200 050 0400 060 R050	6.0	50	1.91	0.5	4	4	°	A5G 0300 060 0600 180 R020	18.0	60	2.85	0.2	6	4	°						
A5G 0200 050 0400 080 R050	8.0	50	1.91	0.5	4	4	°	A5G 0300 060 0600 200 R020	20.0	60	2.85	0.2	6	4	°						
A5G 0200 050 0400 120 R050	12.0	50	1.91	0.5	4	4	°	A5G 0300 075 0600 R020	-	75	-	0.2	6	4	°						
A5G 0200 060 0400 R050	-	60	-	0.5	4	4	°	A5G 0300 075 0600 250 R020	25.0	75	2.85	0.2	6	4	°						
A5G 0200 060 0400 160 R050	16.0	60	1.91	0.5	4	4	°	A5G 0300 075 0600 300 R020	30.0	75	2.85	0.2	6	4	°						
A5G 0200 060 0400 200 R050	20.0	60	1.91	0.5	4	4	°	A5G 0300 050 0600 R030	-	50	-	0.3	6	4	°						
A5G 0250 050 0400 R010	2.5	2	-	50	-	0.1	4	4	°	A5G 0300 050 0600 040 R030	4.0	50	2.85	0.3	6	4	°				
A5G 0250 050 0400 100 R010			10.0	50	2.39	0.1	4	4	°	A5G 0300 050 0600 060 R030	6.0	50	2.85	0.3	6	4	°				
A5G 0250 060 0400 R010			-	60	-	0.1	4	4	°	A5G 0300 050 0600 080 R030	8.0	50	2.85	0.3	6	4	°				
A5G 0250 060 0400 200 R010			20.0	60	2.39	0.1	4	4	°	A5G 0300 050 0600 120 R030	12.0	50	2.85	0.3	6	4	°				
A5G 0250 075 0400 R010			-	75	-	0.1	4	4	°	A5G 0300 060 0600 R030	-	60	-	0.3	6	4	°				
A5G 0250 075 0400 300 R010			30.0	75	2.39	0.1	4	4	°	A5G 0300 060 0600 160 R030	16.0	60	2.85	0.3	6	4	°				
A5G 0250 050 0400 R020			-	50	-	0.2	4	4	°	A5G 0300 060 0600 200 R030	20.0	60	2.85	0.3	6	4	°				
A5G 0250 050 0400 100 R020			10.0	50	2.39	0.2	4	4	°	A5G 0300 075 0600 R030	-	75	-	0.3	6	4	°				
A5G 0250 060 0400 R020			-	60	-	0.2	4	4	°	A5G 0300 075 0600 250 R030	25.0	75	2.85	0.3	6	4	°				
A5G 0250 060 0400 200 R020			20.0	60	2.39	0.2	4	4	°	A5G 0300 075 0600 300 R030	30.0	75	2.85	0.3	6	4	°				
A5G 0250 075 0400 R020			-	75	-	0.2	4	4	°	A5G 0300 050 0600 R050	-	50	-	0.5	6	4	°				
A5G 0250 075 0400 300 R020			30.0	75	2.39	0.2	4	4	°	A5G 0300 050 0600 040 R050	4.0	50	2.85	0.5	6	4	°				
A5G 0250 050 0400 R030			-	50	-	0.3	4	4	°	A5G 0300 050 0600 060 R050	6.0	50	2.85	0.5	6	4	°				
A5G 0250 050 0400 100 R030			10.0	50	2.39	0.3	4	4	°	A5G 0300 050 0600 080 R050	8.0	50	2.85	0.5	6	4	°				
A5G 0250 060 0400 R030			-	60	-	0.3	4	4	°	A5G 0300 050 0600 120 R050	12.0	50	2.85	0.5	6	4	°				
A5G 0250 060 0400 200 R030			20.0	60	2.39	0.3	4	4	°	A5G 0300 060 0600 R050	-	60	-	0.5	6	4	°				
A5G 0250 075 0400 R030			-	75	-	0.3	4	4	°	A5G 0300 060 0600 160 R050	16.0	60	2.85	0.5	6	4	°				
A5G 0250 075 0400 300 R030			30.0	75	2.39	0.3	4	4	°	A5G 0300 060 0600 200 R050	20.0	60	2.85	0.5	6	4	°				
A5G 0250 050 0400 R050			-	50	-	0.5	4	4	°	A5G 0300 075 0600 R050	-	75	-	0.5	6	4	°				
A5G 0250 050 0400 100 R050			10.0	50	2.39	0.5	4	4	°	A5G 0300 075 0600 250 R050	25.0	75	2.85	0.5	6	4	°				
A5G 0250 060 0400 R050	-	60	-	0.5	4	4	°	A5G 0300 075 0600 300 R050	30.0	75	2.85	0.5	6	4	°						
A5G 0250 060 0400 200 R050	20.0	60	2.39	0.5	4	4	°	A5G 0300 050 0600 R100	-	50	-	1	6	4	°						
A5G 0250 075 0400 R050	-	75	-	0.5	4	4	°	A5G 0300 050 0600 080 R100	8.0	50	2.85	1	6	4	°						
A5G 0250 075 0400 300 R050	30.0	75	2.39	0.5	4	4	°	A5G 0300 050 0600 120 R100	12.0	50	2.85	1	6	4	°						
A5G 0300 050 0600 R005	3	2.5	-	50	-	0.05	6	4	°	A5G 0300 060 0600 R100	-	60	-	1	6	4	°				
A5G 0300 050 0600 040 R005			4.0	50	2.85	0.05	6	4	°	A5G 0300 060 0600 160 R100	16.0	60	2.85	1	6	4	°				
A5G 0300 050 0600 060 R005			6.0	50	2.85	0.05	6	4	°	A5G 0300 060 0600 200 R100	20.0	60	2.85	1	6	4	°				
A5G 0300 050 0600 080 R005			8.0	50	2.85	0.05	6	4	°	A5G 0300 075 0600 R100	-	75	-	1	6	4	°				
A5G 0300 050 0600 120 R005			12.0	50	2.85	0.05	6	4	°	A5G 0300 075 0600 250 R100	25.0	75	2.85	1	6	4	°				
A5G 0300 060 0600 R005			-	60	-	0.05	6	4	°	A5G 0300 075 0600 300 R100	30.0	75	2.85	1	6	4	°				
A5G 0300 060 0600 160 R005			16.0	60	2.85	0.05	6	4	°	A5G 0400 050 0600 R010	-	50	-	0.1	6	4	°				
A5G 0300 060 0600 200 R005			20.0	60	2.85	0.05	6	4	°	A5G 0400 050 0600 080 R010	8.0	50	3.8	0.1	6	4	°				

cont'd ▶

Diameter (mm)	Radius Tolerance	Diameter (mm)	Tolerance
D ≤ 25	±0.005	< 1	+0 --0.005
3 < D ≤ 6	±0.010	1 ≤ D ≤ 2.5	+0 --0.010
D > 6	±0.015	2.5 ≤ D ≤ 6	+0 --0.015

Material Group | Material-Gruppe | Groupe Matiere | Gruppo Materiali | 材质主类

Cutting Parameter

N01	N02	N03	K01	K02	P01	P02	P03	M01	M02	S01	S02	S03	H01	H02	O01	O02	324 - 325
-----	-----	-----	-----	-----	-----	-----	-----	-----	-----	-----	-----	-----	-----	-----	-----	-----	-----------

SE 70R MINIATURE TORUS ENDMILLS WITH LONG NECK, 4 FLUTES

- VHM SE 70R Torus-Kleinstfräser mit langem Hals, 4 Zähne
- Micro-frese torodali SE 70R, con collo lungo, 4 taglienti
- Micro-fraises SE 70R toriques avec cou long, 4 dents
- 整体硬质合金 SE 70R 系列 微小径4刃长颈圆鼻铣刀

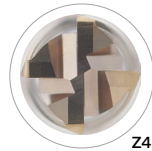

Order Number	Dimension (mm)								B0909+	Order Number	Dimension (mm)								B0909+
	D	I1	I2	L	d1	R	d2(h5)	Z			D	I1	I2	L	d1	R	d2(h5)	Z	
A5G 0400 050 0600 120 R010	4	3.2	12.0	50	3.8	0.1	6	4	°	A5G 0500 075 0600 R050	5	4	-	75	-	0.5	6	4	°
A5G 0400 060 0600 R010			-	60	-	0.1	6	4	°	A5G 0500 075 0600 200 R050			20.0	75	4.75	0.5	6	4	°
A5G 0400 060 0600 160 R010			16.0	60	3.8	0.1	6	4	°	A5G 0500 100 0600 R050			-	100	-	0.5	6	4	°
A5G 0400 075 0600 R010			-	75	-	0.1	6	4	°	A5G 0500 100 0600 400 R050			40.0	100	4.75	0.5	6	4	°
A5G 0400 075 0600 240 R010			24.0	75	3.8	0.1	6	4	°	A5G 0500 060 0600 R100			-	60	-	1	6	4	°
A5G 0400 075 0600 320 R010			32.0	75	3.8	0.1	6	4	°	A5G 0500 060 0600 150 R100			15.0	60	4.75	1	6	4	°
A5G 0400 050 0600 R020			-	50	3.8	0.2	6	4	°	A5G 0500 075 0600 R100			-	75	-	1	6	4	°
A5G 0400 050 0600 080 R020			8.0	50	3.8	0.2	6	4	°	A5G 0500 075 0600 200 R100			20.0	75	4.75	1	6	4	°
A5G 0400 050 0600 120 R020			12.0	50	3.8	0.2	6	4	°	A5G 0500 100 0600 R100			-	100	-	1	6	4	°
A5G 0400 060 0600 R020			-	60	-	0.2	6	4	°	A5G 0500 100 0600 400 R100			40.0	100	4.75	1	6	4	°
A5G 0400 060 0600 160 R020			16.0	60	3.8	0.2	6	4	°	A5G 0600 060 0600 R010			-	60	-	0.1	6	4	°
A5G 0400 075 0600 R020			-	75	-	0.2	6	4	°	A5G 0600 060 0600 120 R010			12.0	60	5.7	0.1	6	4	°
A5G 0400 075 0600 240 R020			24.0	75	3.8	0.2	6	4	°	A5G 0600 075 0600 R010			-	75	-	0.1	6	4	°
A5G 0400 075 0600 320 R020			32.0	75	3.8	0.2	6	4	°	A5G 0600 075 0600 180 R010			18.0	75	5.7	0.1	6	4	°
A5G 0400 050 0600 R030			-	50	3.8	0.3	6	4	°	A5G 0600 075 0600 240 R010			24.0	75	5.7	0.1	6	4	°
A5G 0400 050 0600 080 R030			8.0	50	3.8	0.3	6	4	°	A5G 0600 100 0600 R010			-	100	-	0.1	6	4	°
A5G 0400 050 0600 120 R030			12.0	50	3.8	0.3	6	4	°	A5G 0600 100 0600 480 R010			48.0	100	5.7	0.1	6	4	°
A5G 0400 060 0600 R030			-	60	-	0.3	6	4	°	A5G 0600 060 0600 R020			-	60	-	0.2	6	4	°
A5G 0400 060 0600 160 R030			16.0	60	3.8	0.3	6	4	°	A5G 0600 060 0600 120 R020			12.0	60	5.7	0.2	6	4	°
A5G 0400 075 0600 R030			-	75	-	0.3	6	4	°	A5G 0600 075 0600 R020			-	75	-	0.2	6	4	°
A5G 0400 075 0600 240 R030			24.0	75	3.8	0.3	6	4	°	A5G 0600 075 0600 180 R020			18.0	75	5.7	0.2	6	4	°
A5G 0400 075 0600 320 R030			32.0	75	3.8	0.3	6	4	°	A5G 0600 075 0600 240 R020			24.0	75	5.7	0.2	6	4	°
A5G 0400 050 0600 R050			-	50	-	0.5	6	4	°	A5G 0600 100 0600 R020			-	100	-	0.2	6	4	°
A5G 0400 050 0600 080 R050			8.0	50	3.8	0.5	6	4	°	A5G 0600 100 0600 480 R020			48.0	100	5.7	0.2	6	4	°
A5G 0400 050 0600 120 R050			12.0	50	3.8	0.5	6	4	°	A5G 0600 060 0600 R030			-	60	-	0.3	6	4	°
A5G 0400 060 0600 R050			-	60	-	0.5	6	4	°	A5G 0600 060 0600 120 R030			12.0	60	5.7	0.3	6	4	°
A5G 0400 060 0600 160 R050			16.0	60	3.8	0.5	6	4	°	A5G 0600 075 0600 R030			-	75	-	0.3	6	4	°
A5G 0400 075 0600 R050			-	75	-	0.5	6	4	°	A5G 0600 075 0600 180 R030			18.0	75	5.7	0.3	6	4	°
A5G 0400 075 0600 240 R050			24.0	75	3.8	0.5	6	4	°	A5G 0600 075 0600 240 R030			24.0	75	5.7	0.3	6	4	°
A5G 0400 075 0600 320 R050			32.0	75	3.8	0.5	6	4	°	A5G 0600 100 0600 R030			-	100	-	0.3	6	4	°
A5G 0400 050 0600 R100			-	50	-	1	6	4	°	A5G 0600 100 0600 480 R030			48.0	100	5.7	0.3	6	4	°
A5G 0400 050 0600 080 R100			8.0	50	3.8	1	6	4	°	A5G 0600 060 0600 R050			-	60	-	0.5	6	4	°
A5G 0400 050 0600 120 R100			12.0	50	3.8	1	6	4	°	A5G 0600 060 0600 120 R050			12.0	60	5.7	0.5	6	4	°
A5G 0400 060 0600 R100			-	60	-	1	6	4	°	A5G 0600 075 0600 R050			-	75	-	0.5	6	4	°
A5G 0400 060 0600 160 R100			16.0	60	3.8	1	6	4	°	A5G 0600 075 0600 180 R050			18.0	75	5.7	0.5	6	4	°
A5G 0400 075 0600 R100			-	75	-	1	6	4	°	A5G 0600 075 0600 240 R050			24.0	75	5.7	0.5	6	4	°
A5G 0400 075 0600 240 R100			24.0	75	3.8	1	6	4	°	A5G 0600 100 0600 R050			-	100	-	0.5	6	4	°
A5G 0400 075 0600 320 R100			32.0	75	3.8	1	6	4	°	A5G 0600 100 0600 480 R050			48.0	100	5.7	0.5	6	4	°
A5G 0500 060 0600 R010			-	60	-	0.1	6	4	°	A5G 0600 060 0600 R100			-	60	-	1	6	4	°
A5G 0500 060 0600 150 R010			15.0	60	4.75	0.1	6	4	°	A5G 0600 060 0600 120 R100			12.0	60	5.7	1	6	4	°
A5G 0500 075 0600 R010			-	75	-	0.1	6	4	°	A5G 0600 075 0600 R100			-	75	-	1	6	4	°
A5G 0500 075 0600 200 R010			20.0	75	4.75	0.1	6	4	°	A5G 0600 075 0600 180 R100			18.0	75	5.7	1	6	4	°
A5G 0500 100 0600 R010			-	100	-	0.1	6	4	°	A5G 0600 075 0600 240 R100			24.0	75	5.7	1	6	4	°
A5G 0500 100 0600 400 R010			40.0	100	4.75	0.1	6	4	°	A5G 0600 100 0600 R100			-	100	-	1	6	4	°
A5G 0500 060 0600 R020	-	60	-	0.2	6	4	°	A5G 0600 100 0600 480 R100	48.0	100	5.7	1	6	4	°				
A5G 0500 060 0600 150 R020	15.0	60	4.75	0.2	6	4	°												
A5G 0500 075 0600 R020	-	75	-	0.2	6	4	°												
A5G 0500 075 0600 200 R020	20.0	75	4.75	0.2	6	4	°												
A5G 0500 100 0600 R020	-	100	-	0.2	6	4	°												
A5G 0500 100 0600 400 R020	40.0	100	4.75	0.2	6	4	°												
A5G 0500 060 0600 R030	-	60	-	0.3	6	4	°												
A5G 0500 060 0600 150 R030	15.0	60	4.75	0.3	6	4	°												
A5G 0500 075 0600 R030	-	75	-	0.3	6	4	°												
A5G 0500 075 0600 200 R030	20.0	75	4.75	0.3	6	4	°												
A5G 0500 100 0600 R030	-	100	-	0.3	6	4	°												
A5G 0500 100 0600 400 R030	40.0	100	4.75	0.3	6	4	°												
A5G 0500 060 0600 R050	-	60	-	0.5	6	4	°												
A5G 0500 060 0600 150 R050	15.0	60	4.75	0.5	6	4	°												

Diameter (mm)	Radius Tolerance	Diameter (mm)	Tolerance
D ≤ 2.5	±0.005	< 1	+0 --0.005
3 < D ≤ 6	±0.010	1 ≤ D ≤ 2.5	+0 --0.010
D > 6	±0.015	2.5 ≤ D ≤ 6	+0 --0.015

Material Group | Material-Gruppe | Groupe Matiere | Gruppo Materiali | 材质主类

Cutting Parameter

N01	N02	N03	K01	K02	P01	P02	P03	M01	M02	S01	S02	S03	H01	H02	O01	O02	324 - 325
-----	-----	-----	-----	-----	-----	-----	-----	-----	-----	-----	-----	-----	-----	-----	-----	-----	-----------

FEATURES & BENEFITS

DM70 (SE 70)



Top View

1 Multi-Flute (MF)

- Large number of cutting edges up to 7 flutes
- Higher feed rate (up to 75% more compared to 4 flutes design)
- Greater core strength and minimized tool deflection
- Higher quality of surface finishing

2 Differential Helix (DH)



- Minimized vibrations and harmonics oscillations
- Excellent in surface finish, chatter free and wall straightness
- Increases tool life and productivity performance

3 High Helix Angle

- Higher stability to reduce vibration and chattering
- Shaper radius rake angle to reduce spindle load
- Increases tool life and productivity performance



4 S-Gash Radius Design



- Perfect joining between corner radius and outer diameter to achieve higher accuracy radius contour
- More reliability corner radius with lower risk of chipping
- Better surface finishing quality
- Stronger corner radius design to increase tool life
- More quiet during machining and good to production machinist well-being

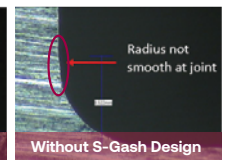
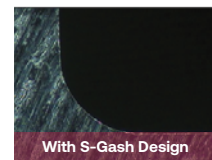

5 Suitable for Material

H



1. Mehrschneidig (MF)
Große Anzahl von Schneidkanten mit bis zu 7 Schneiden
Höhere Vorschubgeschwindigkeiten und Produktivität (75% mehr Vorschub im Vergleich zu 4 Schneiden)
Höhere Kernfestigkeit und minimierte Werkzeugdurchbiegung
Höhere Qualität der Oberflächenbearbeitung
2. ungleiche Drall (DH)
Minimierung von Vibrationen und Resonanzen während der Bearbeitung
ausgezeichnete Oberflächengüte, keine Vibrationen und Wandgeradheit
erhöht die Werkzeugstandzeit und Produktivität
3. Hoher Drallwinkel
Geringere radiale Schnittkraft zur Reduzierung von Vibrationen während der Bearbeitung
Bessere Scherung für eine höhere Qualität der Oberflächengüte.
Höhere Effizienz bei der Spanabfuhr mit geringerem Eingriff in die Schneidkante
4. S-Gash-Radius Geometrie
perfekte Übergänge zwischen Eckenradius und Außendurchmesser für eine höhere Genauigkeit der Radiuskontur
zuverlässigerer Eckenradius mit geringerem Risiko von Ausbrüchen
bessere Oberflächengüte bei der Bearbeitung von Bauteilen
verstärkte Eckenradien zur Erhöhung der Werkzeugstandzeit
ruhiger bei der Bearbeitung und gut für das Wohlbefinden des Produktionsmitarbeiters.
5. Geeignet für Materialgruppe H



1. 多槽型 (MF)
多达 7 个刃口的切削刃
可有效提高进给率和生产率 (与 4 个槽相比, 进给率提高 75%)
具有更大的核心强度, 实现最小的刀具偏移
提供更高质量的表面处理
2. 不等距螺旋设计
最大限度地减少加工过程中的震动
具有优异的表面光洁度、无颤振和侧壁垂直
延长刀具寿命和提高其生产效能
3. 高螺旋角
降低径向切削力以减少加工过程中的振动
最佳的切削, 提高工件光洁度
更有效排屑, 更少的刃口接触
4. 刃带弧度设计
圆角半径与外径之间的完美连接, 以实现更高精度的半径轮廓
更可靠的圆弧可降低崩损风险
具有更好的加工部件表面精加工质量
更强的圆角半径设计以延长刀具寿命
可降低加工过程中的噪音, 有利于作业人员的健康
5. 适用于加工材料 H



1. Multitagliente
Fino a 7 taglienti
Velocità di avanzamento più elevata (fino al 75% in più rispetto a 4 taglienti)
Flessione dell'utensile ridotta al minimo
Qualità ottimale della finitura superficiale
2. Elica differenziale (DH)
Vibrazioni e oscillazioni ridotte al minimo
Eccellente nella finitura superficiale e rettilineità della parete
Aumenta la durata dell'utensile e la produttività
3. Angolo d'elica elevato
Forza di taglio radiale inferiore per ridurre le vibrazioni
Migliore qualità della finitura superficiale
Maggiore efficienza nell'evacuazione del truciolo
4. Disegno del profilo della scanalatura
Raccordo ideale tra il profilo interno e il diametro esterno
Minor rischio di scheggiatura
Migliore qualità di finitura superficiale
Maggior durata dell'utensile
Lavorazione più dolce
5. Adatto per il materiale H



1. Multi-Flûte (MF)
Grand nombre d'arêtes de coupe jusqu'à 7 goujures
Vitesses d'avance et productivité significativement plus élevées
(Augmenter la vitesse d'avance de 75% par rapport à 4 goujures)
Plus grande résistance du noyau et déviation de l'outil minimisée
Meilleure qualité de finition de surface
2. Conception à hélice variable
Vibrations et oscillations harmoniques minimisées pendant l'usinage
Excellent en finition de surface, sans bavardage et rectiligne de mur
Augmente la durée de vie de l'outil et les performances de productivité
3. Angle d'hélice élevé
Force de coupe radiale inférieure pour réduire les vibrations pendant l'usinage
Meilleur cisaillement pour une meilleure qualité de finition de surface
Plus efficace dans l'évacuation des copeaux avec un engagement plus faible dans l'arête de coupe
4. Conception de rayon S-Gash
Jointure parfaite entre le rayon d'angle et le diamètre extérieur pour obtenir un contour de rayon plus précis
Rayon d'angle plus fiable avec moins de risque d'écaillage
Meilleure qualité de finition de surface sur le composant d'usinage
Conception de rayon de coin plus fort pour augmenter la durée de vie de l'outil
Plus silencieux pendant l'usinage et bon pour le bien-être des machinistes de production
5. Adapté aux matériaux H

SE 70 DH MULTIFLUTE TORUS ENDMILLS WITH RECESS, 6/7 FLUTES

- VHM DH Mehrzahnfräser SE 70 - 6/7 Zähne
- Frese multi-taglienti SE 70 DH in metallo duro integrale, 6/7 taglienti
- Fraises Multidentés SE 70 DH, 6/7 dents
- 整体硬质合金 SE 70 DH 系列 密齿6/7刃圆鼻铣刀

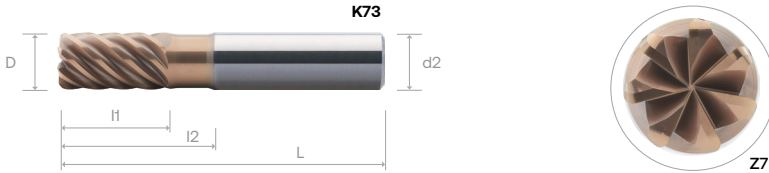

Order Number	Dimension (mm)							B0909
	D	L1	L2	L	d2 (h6)	R	Z	
K73 0300 057 0600 020	3	8	20	57	6	0.2	6	•
K73 0400 057 0600 020	4	11	20	57	6	0.2	6	•
K73 0500 057 0600 030	5	12	20	57	6	0.3	6	•
K73 0600 057 0600 050	6	15	20	57	6	0.5	7	•
K73 0600 057 0600 100			20	57	6	1	7	•
K73 0800 064 0800 050	8	20	26	64	8	0.5	7	•
K73 0800 064 0800 080			26	64	8	0.8	7	•
K73 1000 072 1000 050	10	22	30	72	10	0.5	7	•
K73 1000 072 1000 080			30	72	10	0.8	7	◦
K73 1000 072 1000 100			30	72	10	1	7	•
K73 1200 083 1200 050	12	25	36	83	12	0.5	7	◦
K73 1200 083 1200 100			36	83	12	1	7	◦
K73 1200 083 1200 150			36	83	12	1.5	7	◦
K73 1600 092 1600 200	16	30	42	92	16	2	7	◦
K73 1600 092 1600 300			42	92	16	3	7	◦
K73 2000 104 2000 300	20	38	52	104	20	3	7	◦

Diameter (mm)	Tolerance
D ≤ 2.5	-0.015 ~ +0
2.5 ≤ D ≤ 5	-0.020 ~ +0
6 ≤ D ≤ 10	-0.025 ~ +0
10 < D ≤ 12	-0.005 ~ -0.030
D > 12	-0.010 ~ -0.035

Material Group | Material-Gruppe | Groupe Matière | Gruppo Materiali | 材质主类

Cutting Parameter

N01	N02	N03	K01	K02	P01	P02	P03	M01	M02	S01	S02	S03	H01	H02	O01	O02	318
-----	-----	-----	-----	-----	-----	-----	-----	-----	-----	-----	-----	-----	-----	-----	-----	-----	-----

FEATURES & BENEFITS

DM70 (SE 70)



Top View

1 Multi-Flute (MF)

- Large number of cutting edges up to 7 flutes
- Higher feed rate (up to 75% more compared to 4 flutes design)
- Greater core strength and minimized tool deflection
- Higher quality of surface finishing

2 Differential Helix (DH)



- Minimized vibrations and harmonics oscillations
- Excellent in surface finish, chatter free and wall straightness
- Increases tool life and productivity performance

3 High Helix Angle

- Lower radial cutting force to reduce vibrations
- Better shearing to deliver higher quality of surface finishing
- Higher efficient in chip evacuation with lower engagement in cutting edge



4 Ultra Fine Grain Cemented Carbide (UF+)

- Higher hardness for higher material removal rate machining
- Provides higher toughness, strength and edge retention
- Excellent performance in machining high hardness materials
- Reduce the risk of chipping and increases reliability

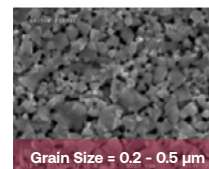

New Carbide

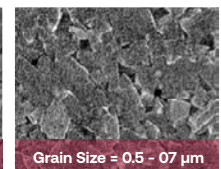

Old Carbide

5 Gash Land Design



- Reinforce edge protection of the cutting tool corner
- Higher mechanical strength to withstand greater cutting force
- Greater process reliability and longer tool life

6 Suitable for Material

H



1. Mehrschneidig (MF)
Große Anzahl von Schneidkanten mit bis zu 7 Schneiden
Höhere Vorschubgeschwindigkeiten und Produktivität (75% mehr Vorschub im Vergleich zu 4 Schneiden)
Höhere Kernfestigkeit und minimierte Werkzeugdurchbiegung
Höhere Qualität der Oberflächenbearbeitung
2. ungleiche Drall (DH)
Minimierung von Vibrationen und Resonanzen während der Bearbeitung
ausgezeichnete Oberflächengüte, keine Vibrationen und Wandgeradheit
erhöht die Werkzeugstandzeit und Produktivität
3. Hoher Drallwinkel
Geringere radiale Schnittkraft zur Reduzierung von Vibrationen während der Bearbeitung
Bessere Scherung für eine höhere Qualität der Oberflächengüte.
Höhere Effizienz bei der Spanabfuhr mit geringerem Eingriff in die Schneidkante
4. ultrafeinkörniges Hartmetall (UF+)
höhere Standzeit bei der Materialabtragsrate
höhere Werkzeugfestigkeit, Beständigkeit und Kantenstabilität.
ausgezeichnete Leistung bei der Bearbeitung von härteren Stählen.
verringert das Risiko von Ausbrüchen und erhöht die Zuverlässigkeit
5. Stirnschliff Design
Verstärkung des Kantenschutzes der Schneidkanten.
Höhere mechanische Festigkeit, um größeren Schnittkräften zu widerstehen.
konstante Bearbeitungszeit und höhere Werkzeugstandzeit
6. Geeignet für Materialgruppe H



1. 多槽型 (MF)
多达 7 个刃口的切削刃
可有效提高进给率和生产率 (与 4 个槽相比, 进给率提高 75%)
具有更大的核心强度, 实现最小的刀具偏移
提供更高质量的表面处理
2. 不等距螺旋设计
最大限度地减少加工过程中的震动
具有优异的表面光洁度、无颤振和侧壁垂直
延长刀具寿命和提高其生产效能
3. 高螺旋角
降低径向切削力以减少加工过程中的振动
更佳的切削, 提高工件光洁度
更有效排屑, 更少的刃口接触
4. 超细颗粒硬质合金 (UF+)
材料去除率 (MRR) 的耐久性更高
更高的韧性、强度和刃口坚固
加工高强度材料的性能更优越
减轻崩损, 提高稳定性
5. 刃带设计
强化刃锋保护
应用于高强度切削时, 提供更好的抗力
可延长加工时间并提高刀具的耐用性
6. 适用于加工材料 H



1. Multitagliente
Fino a 7 taglienti
Velocità di avanzamento più elevata (fino al 75% in più rispetto a 4 taglienti)
Flessione dell'utensile ridotta al minimo
Qualità ottimale della finitura superficiale
2. Elica differenziale (DH)
Vibrazioni e oscillazioni ridotte al minimo
Eccellente nella finitura superficiale e rettilineità della parete
Aumenta la durata dell'utensile e la produttività
3. Angolo d'elica elevato
Forza di taglio radiale inferiore per ridurre le vibrazioni
Migliore qualità della finitura superficiale
Maggiore efficienza nell'evacuazione del truciolo
4. Metallo duro cementato a grana ultra fine (UF+)
Maggiore durata per alta rimozione del materiale (MRR)
Maggiore tenacità dell'utensile, resistenza e durata del tagliente
Eccellenti prestazioni nella lavorazione di materiali temprati
Riduce il rischio di scheggiatura e aumenta l'affidabilità
5. Disegno della scanalatura
Maggior protezione dell'elica del tagliente
Maggiore resistenza meccanica alla forza di taglio
Maggiore regolarità dei tempi di lavorazione
6. Adatto per il materiale H



1. Multi-Flûte (MF)
Grand nombre d'arêtes de coupe jusqu'à 7 goujures
Vitesses d'avance et productivité significativement plus élevées
(Augmenter la vitesse d'avance de 75% par rapport à 4 goujures)
Plus grande résistance du noyau et déviation de l'outil minimisée
Meilleure qualité de finition de surface
2. Conception à hélice variable
Vibrations et oscillations harmoniques minimisées pendant l'usinage
Excellent en finition de surface, sans bavardage et rectiligne de mur
Augmente la durée de vie de l'outil et les performances de productivité
3. Angle d'hélice élevé
Force de coupe radiale inférieure pour réduire les vibrations pendant l'usinage
Meilleur cisaillement pour une meilleure qualité de finition de surface
Plus efficace dans l'évacuation des copeaux avec un engagement plus faible dans l'arête de coupe
4. Carbure cémenté à grain ultra fin (UF+)
Durabilité plus élevée pour le taux d'enlèvement de matière (MRR)
Plus grande ténacité globale de l'outil, résistance et rétention des bords
Excellentes performances dans l'usinage de matériaux de haute dureté
Réduit le risque d'écaillage et augmente la fiabilité
5. Conception de fraise pour l'usinage general
Renforcer la protection des bords du coin de l'outil de coupe
Résistance mécanique plus élevée pour résister à une force de coupe plus importante
Une durée d'usinage plus longue et une plus grande durabilité de l'outil
6. Adapté aux matériaux H

SE 70 DH MULTIFLUTE ENDMILLS, 6/7 FLUTES

- VHM DH Mehrzahnfräser SE 70 - 6/7 Zähne
- Frese multi-taglienti SE 70 DH in metallo duro integrale, 6/7 taglienti
- Fraises Multidentés SE 70 DH, 6/7 dents
- 整体硬质合金 SE 70 系列 密齿6/7刃平底铣刀

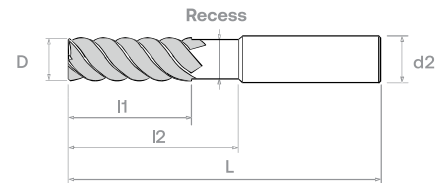
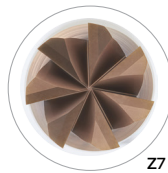
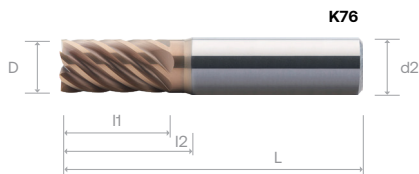

Order Number	Dimension (mm)						B0909	Order Number	Dimension (mm)						B0909
	D	l1	l2	L	d2 (h6)	Z			D	l1	l2	L	d2 (h6)	Z	
K76 0300 057 06	3	8	20	57	6	6	•	K77 0300 057 06	3	8		57	6	6	•
K76 0400 057 06	4	11	20	57	6	6	•	K77 0400 057 06	4	11		57	6	6	•
K76 0500 057 06	5	12	20	57	6	6	◦	K77 0500 057 06	5	12		57	6	6	•
K76 0600 057	6	15	20	57	6	7	•	K77 0600 057	6	15		57	6	7	•
K76 0800 064	8	20	26	64	8	7	•	K77 0800 064	8	20		64	8	7	•
K76 1000 072	10	22	30	72	10	7	•	K77 1000 072	10	22		72	10	7	•
K76 1200 083	12	25	36	83	12	7	•	K77 1200 083	12	25		83	12	7	•
K76 1600 092	16	30	42	92	16	7	•	K77 1600 092	16	30		92	16	7	◦
K76 2000 104	20	38	52	104	20	7	•	K77 2000 104	20	38		104	20	7	◦

ALL LINE
 EZ LINE -
 ENDMILL
 SE 30
 NITICO 30
 OPTIMUM
 SE 45
 SE 45X
 NITICO 45
 SE 60
 SE 60X
 DM70 -
 SE 70
 SE GR
 TE 45
 PLUNGE
 -MILL
 THREAD
 MILL

Diameter (mm)	Tolerance
D ≤ 2.5	-0.015 ~ +0
2.5 ≤ D ≤ 5	-0.020 ~ +0
6 ≤ D ≤ 10	-0.025 ~ +0
10 < D ≤ 12	-0.005 ~ -0.030
D > 12	-0.010 ~ -0.035

Material Group | Material-Gruppe | Groupe Matière | Gruppo Materiali | 材质主类

Cutting Parameter

N01	N02	N03	K01	K02	P01	P02	P03	M01	M02	S01	S02	S03	H01	H02	O01	O02	318
-----	-----	-----	-----	-----	-----	-----	-----	-----	-----	-----	-----	-----	-----	-----	-----	-----	-----

Note: These recommended cutting data indicators are just for reference. They should be adjusted according to the different cutting condition



ALU LINE - ENDMILL
 SE 30
 NITCo 30
 OPTIMUM
 SE 45
 SE 45X
 NITCo 45
 SE 60
 SE 60X
 DM70 - SE 70
 SE GR
 TE 45
 PLUNGE -MILL
 THREAD MILL

SE 70 Endmill, 4 Flutes - A5F, A5M

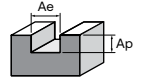

Slotting	H					
Working Material	Hardened Steel		Hardened Steel		Hardened Steel	
Properties	50 ≤ HRC ≤ 55		55 < HRC ≤ 65		65 < HRC ≤ 70	
Cutting depth, ap	0.02 × D		0.01 × D		0.01 × D	
Cutting Width, ae	1 × D		1 × D		1 × D	
D	Vc	Fz	Vc	Fz	Vc	Fz
1	52	0.008	44	0.008	36	0.008
2	79	0.014	69	0.013	60	0.011
3	80	0.026	75	0.019	71	0.015
4	85	0.041	79	0.026	72	0.022
5	90	0.034	82	0.021	74	0.018
6	90	0.044	80	0.025	70	0.023
8	82	0.072	82	0.033	80	0.026
10	86	0.100	83	0.041	79	0.033
12	85	0.141	81	0.054	75	0.046
16	90	0.236	85	0.096	80	0.078
20	94	0.250	94	0.100	88	0.089

SE 70 Endmill, 4 Flutes - A5F, A5M

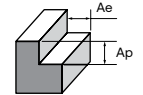

Side milling	H					
Working Material	Hardened Steel		Hardened Steel		Hardened Steel	
Properties	50 ≤ HRC ≤ 55		55 < HRC ≤ 65		65 < HRC ≤ 70	
Cutting depth, ap	1.00 × D ~ 1.50 × D		1.00 × D ~ 1.50 × D		1.00 × D ~ 1.50 × D	
Cutting Width, ae	0.02 × D		0.01 × D		0.01 × D	
D	Vc	Fz	Vc	Fz	Vc	Fz
1	49	0.009	44	0.008	36	0.008
2	66	0.017	50	0.016	38	0.017
3	71	0.028	52	0.023	38	0.025
4	72	0.041	57	0.031	38	0.038
5	75	0.035	55	0.026	39	0.030
6	71	0.049	47	0.037	38	0.038
8	75	0.072	63	0.037	50	0.038
10	74	0.099	63	0.046	57	0.042
12	75	0.125	68	0.056	60	0.052
16	90	0.130	80	0.057	70	0.054
20	88	0.155	82	0.064	75	0.063

Note: These recommended cutting data indicators are just for reference. They should be adjusted according to the different cutting condition



SE 70R Endmills, 4 Flutes - A5H, A5J

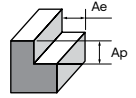

Side milling	H					
Working Material	Hardened Steel		Hardened Steel		Hardened Steel	
Properties	50 ≤ HRC ≤ 55		55 < HRC ≤ 65		65 < HRC ≤ 70	
Cutting depth, ap	0.18 × R		0.12 × R		0.09 × R	
Cutting Width, ae	(D/2)-R		(D/2)-R		(D/2)-R	
D	Vc	Fz	Vc	Fz	Vc	Fz
1	80	0.035	70	0.015	60	0.014
2		0.080		0.032		0.030
3		0.135		0.053		0.050
4		0.190		0.076		0.072
5		0.243		0.097		0.092
6		0.300		0.121		0.115
8		0.402		0.160		0.152
10		0.480		0.198		0.188
12		0.560		0.230		0.219
16		0.640		0.251		0.240
20		0.660		0.255		0.250

1. Suitable to use in down cutting or contour lines. Reduce the feed rate between 60% and 70% when cutting at an incline (incline angle: 1°) in Z direction.
2. It is recommended to reduce the speed for corners be set. The speed reduction is approximately 1/2 of the diameter tool, and the feed rate need to be reduced between 50% and 60%.

SE 70 Multiflutes Endmills, 6 Flute - K73, K76, K77

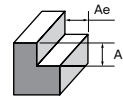

Side Milling	H			
Working Material	Hardened steel		Hardened steel	
Properties	45 ≤ HRC < 52		52 ≤ HRC < 68	
Cutting depth, ap	1.00 × D		1.00 × D	
Cutting Width, ae	0.05 × D		0.05 × D	
D	Vc	Fz	Vc	Fz
3	150	0.011	110	0.01
4		0.016		0.015
5		0.021		0.019

SE 70 Multiflutes Endmills, 7 Flutes - K73, K76, K77

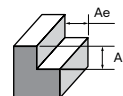

Side Milling	H			
Working Material	Hardened steel		Hardened steel	
Properties	45 ≤ HRC < 52		52 ≤ HRC < 68	
Cutting depth, ap	1.00 × D		1.00 × D	
Cutting Width, ae	0.05 × D		0.05 × D	
D	Vc	Fz	Vc	Fz
6	150	0.027	110	0.025
8		0.038		0.035
10		0.050		0.046
12		0.066		0.059
16		0.085		0.075
20		0.099		0.09

Note: These recommended cutting data indicators are just for reference. They should be adjusted according to the different cutting condition

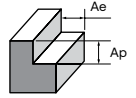

SE 70 Miniature Endmills With Long Neck, 2 Flutes - A5D

Side Milling		H							
Working Material		Hardened steel				Hardened steel			
Properties		45 ≤ HRC < 52				52 ≤ HRC < 68			
D	Effective Length	Ap	Ae	N	Fz	Ap	Ae	N	Fz
0.10	-	0.003	0.05	44000	0.001	0.002	0.05	40000	0.001
	0.30	0.003	0.05	44000	0.001	0.002	0.05	40000	0.001
	0.50	0.003	0.05	44000	0.001	0.002	0.05	40000	0.001
	0.75	0.002	0.05	44000	0.001	0.001	0.05	40000	0.001
	1.00	0.001	0.05	44000	0.001	0.001	0.05	40000	0.001
0.15	-	0.003	0.075	44000	0.002	0.002	0.075	40000	0.001
	0.30	0.003	0.075	44000	0.002	0.002	0.075	40000	0.001
	0.50	0.003	0.075	44000	0.001	0.002	0.075	40000	0.001
	0.75	0.002	0.075	44000	0.001	0.001	0.075	40000	0.001
	1.00	0.001	0.075	44000	0.001	0.001	0.075	40000	0.001
0.20	-	0.003	0.1	33000	0.003	0.003	0.1	30000	0.001
	0.50	0.003	0.1	33000	0.003	0.003	0.1	30000	0.001
	0.75	0.003	0.1	33000	0.002	0.003	0.1	30000	0.001
	1.00	0.003	0.1	33000	0.002	0.003	0.1	30000	0.001
	1.50	0.002	0.1	33000	0.001	0.002	0.1	30000	0.001
0.20	2.00	0.002	0.1	33000	0.001	0.002	0.1	30000	0.001
	2.50	0.001	0.1	33000	0.001	0.001	0.1	25000	0.001
	3.00	0.001	0.1	27500	0.001	0.001	0.1	25000	0.001
	-	0.003	0.15	33000	0.006	0.003	0.15	30000	0.005
	1.00	0.003	0.15	33000	0.005	0.003	0.15	30000	0.004
0.30	1.50	0.003	0.15	33000	0.003	0.003	0.15	30000	0.003
	2.00	0.003	0.15	33000	0.002	0.003	0.15	30000	0.002
	2.50	0.002	0.15	27500	0.002	0.002	0.15	25000	0.001
	3.00	0.002	0.15	27500	0.001	0.002	0.15	25000	0.001
	-	0.005	0.2	33000	0.006	0.005	0.2	30000	0.006
0.40	1.00	0.005	0.2	33000	0.005	0.005	0.2	30000	0.005
	1.50	0.005	0.2	33000	0.005	0.005	0.2	30000	0.005
	2.00	0.005	0.2	33000	0.005	0.005	0.2	25000	0.005
	2.50	0.005	0.2	27500	0.005	0.004	0.2	25000	0.005
	3.00	0.004	0.2	27500	0.005	0.003	0.2	20000	0.006
	3.50	0.004	0.2	27500	0.004	0.003	0.2	20000	0.005
	4.00	0.003	0.2	27500	0.004	0.002	0.2	20000	0.004
	5.00	0.003	0.2	24200	0.004	0.002	0.2	20000	0.004
	6.00	0.002	0.2	24200	0.003	0.002	0.2	18000	0.004
	8.00	0.001	0.2	17600	0.003	0.001	0.2	14000	0.003
10.00	0.001	0.2	14300	0.003	0.001	0.2	12000	0.002	
0.50	-	0.01	0.25	27500	0.010	0.007	0.25	23000	0.011
	1.00	0.01	0.25	27500	0.009	0.007	0.25	23000	0.009
	1.50	0.01	0.25	27500	0.008	0.007	0.25	23000	0.009
	2.00	0.01	0.25	27500	0.008	0.007	0.25	23000	0.008
	2.50	0.008	0.25	27500	0.007	0.006	0.25	23000	0.008
	3.00	0.007	0.25	27500	0.006	0.005	0.25	23000	0.007
	3.50	0.006	0.25	27500	0.006	0.003	0.25	23000	0.006
	4.00	0.005	0.25	27500	0.005	0.003	0.25	23000	0.005
	4.50	0.004	0.25	27500	0.004	0.003	0.25	20000	0.005
	5.00	0.003	0.25	22000	0.005	0.003	0.25	18000	0.005
	6.00	0.003	0.25	22000	0.005	0.002	0.25	18000	0.004
	7.00	0.003	0.25	17600	0.005	0.002	0.25	14000	0.005
	8.00	0.002	0.25	17600	0.005	0.002	0.25	14000	0.005
	9.00	0.002	0.25	17600	0.004	0.001	0.25	14000	0.004
10.00	0.002	0.25	14300	0.005	0.001	0.25	12000	0.005	

cont'd ▶

ALU LINE - ENDMILL
 SE 30
 NITCo 30
 OPTIMUM
 SE 45
 SE 45X
 SE 45X
 NITCo 45
 SE 60
 SE 60X
 DM70 - SE 70
 SE GR
 TE 45
 PLUNGE -MILL
 THREAD MILL

Note: These recommended cutting data indicators are just for reference. They should be adjusted according to the different cutting condition

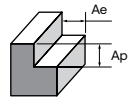

SE 70 Miniature Endmills With Long Neck, 2 Flutes - A5D

Side Milling		H							
Working Material		Hardened steel				Hardened steel			
Properties		45 ≤ HRC < 52				52 ≤ HRC < 68			
D	Effective Length	Ap	Ae	N	Fz	Ap	Ae	N	Fz
0.60	-	0.01	0.3	27500	0.011	0.007	0.3	23000	0.010
	1.50	0.01	0.3	27500	0.010	0.007	0.3	23000	0.010
	2.00	0.01	0.3	27500	0.009	0.007	0.3	23000	0.008
	3.00	0.007	0.3	27500	0.008	0.005	0.3	23000	0.007
	4.00	0.005	0.3	27500	0.007	0.003	0.3	23000	0.006
	5.00	0.003	0.3	22000	0.008	0.003	0.3	18000	0.006
	6.00	0.002	0.3	22000	0.006	0.002	0.3	18000	0.005
	8.00	0.002	0.3	17600	0.006	0.002	0.3	18000	0.002
0.80	-	0.03	0.4	27500	0.017	0.02	0.4	23000	0.018
	3.00	0.03	0.4	27500	0.015	0.02	0.4	23000	0.016
	4.00	0.025	0.4	27500	0.013	0.015	0.4	23000	0.013
	5.00	0.02	0.4	25300	0.012	0.012	0.4	20000	0.013
	6.00	0.02	0.4	22000	0.012	0.01	0.4	18000	0.013
	8.00	0.007	0.4	17600	0.011	0.005	0.4	14000	0.010
	10.00	0.007	0.4	17600	0.011	0.005	0.4	12000	0.012
	12.00	0.005	0.4	14300	0.013	0.003	0.4	12000	0.011
1.00	-	0.06	0.5	23000	0.022	0.05	0.5	18000	0.025
	2.0	0.06	0.5	23000	0.022	0.05	0.5	18000	0.025
	3.0	0.05	0.5	23000	0.022	0.04	0.5	18000	0.025
	4.0	0.04	0.5	23000	0.020	0.03	0.5	18000	0.022
	5.0	0.03	0.5	20000	0.020	0.02	0.5	16000	0.022
	6.0	0.02	0.5	18000	0.019	0.01	0.5	14000	0.021
	7.0	0.02	0.5	18000	0.018	0.01	0.5	14000	0.020
	8.0	0.02	0.5	16000	0.019	0.01	0.5	12000	0.021
	9.0	0.015	0.5	16000	0.017	0.007	0.5	12000	0.019
	10.0	0.01	0.5	14000	0.018	0.007	0.5	10000	0.020
	12.0	0.01	0.5	13000	0.015	0.005	0.5	10000	0.015
	14.0	0.008	0.5	13000	0.014	0.005	0.5	10000	0.014
	16.0	0.006	0.5	12000	0.013	0.004	0.5	9000	0.014
	18.0	0.006	0.5	12000	0.010	0.004	0.5	8000	0.013
20.0	0.005	0.5	10000	0.008	0.003	0.5	7000	0.009	
22.0	0.003	0.5	10000	0.008	0.002	0.5	6000	0.008	
1.20	-	0.03	0.6	18000	0.019	0.02	0.6	14000	0.021
	6.00	0.03	0.6	18000	0.019	0.02	0.6	14000	0.021
	8.00	0.02	0.6	16000	0.019	0.01	0.6	12000	0.021
	10.00	0.02	0.6	12000	0.021	0.01	0.6	10000	0.022
	12.00	0.01	0.6	10000	0.025	0.007	0.6	9000	0.022
	16.00	0.01	0.6	9000	0.017	0.005	0.6	8000	0.016
1.40	-	0.04	0.7	20000	0.020	0.03	0.7	18000	0.019
	6.00	0.04	0.7	20000	0.020	0.03	0.7	18000	0.019
	12.00	0.01	0.7	13000	0.019	0.007	0.7	11000	0.018
1.50	-	0.05	0.75	20000	0.023	0.04	0.75	18000	0.022
	4.00	0.05	0.75	20000	0.023	0.04	0.75	18000	0.022
	6.00	0.04	0.75	20000	0.020	0.03	0.75	18000	0.019
	8.00	0.03	0.75	18000	0.017	0.03	0.75	14000	0.021
	10.00	0.03	0.75	16000	0.016	0.02	0.75	14000	0.018
	12.00	0.02	0.75	14000	0.018	0.02	0.75	12000	0.018
	14.00	0.02	0.75	12000	0.017	0.01	0.75	10000	0.019
	16.00	0.01	0.75	10000	0.018	0.007	0.75	9000	0.017
	18.00	0.008	0.75	9000	0.018	0.005	0.75	8000	0.016
	20.00	0.005	0.75	8000	0.018	0.004	0.75	7000	0.014
	25.00	0.004	0.75	7000	0.014	0.003	0.75	6000	0.013
	30.00	0.003	0.75	6000	0.013	0.002	0.75	5000	0.011
35.00	0.002	0.75	5000	0.011	0.002	0.75	4500	0.010	

ALL LINE
EZ LINE -
ENDMILL
SE 30
NITCO 30
OPTIMUM
SE 45
SE 45X
NITCO 45
SE 60
SE 60X
DM70 -
SE 70
SE GR
TE 45
PLUNGE
-MILL
THREAD
MILL

cont'd ▶

Note: These recommended cutting data indicators are just for reference. They should be adjusted according to the different cutting condition

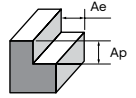

SE 70 Miniature Endmills With Long Neck, 2 Flutes - A5D

Side Milling		H							
Working Material		Hardened steel				Hardened steel			
Properties		45 ≤ HRC < 52				52 ≤ HRC < 68			
D	Effective Length	Ap	Ae	N	Fz	Ap	Ae	N	Fz
1.60	-	0.04	0.8	19000	0.022	0.03	0.8	17000	0.022
	6.00	0.04	0.8	19000	0.022	0.03	0.8	17000	0.022
	8.00	0.03	0.8	17000	0.022	0.03	0.8	14000	0.021
1.80	-	0.05	0.9	18000	0.025	0.04	0.9	15000	0.025
	6.00	0.05	0.9	18000	0.025	0.04	0.9	15000	0.025
	8.00	0.04	0.9	16000	0.025	0.03	0.9	12000	0.025
	10.00	0.04	0.9	14000	0.025	0.03	0.9	12000	0.021
	12.00	0.03	0.9	12000	0.025	0.02	0.9	10000	0.025
	14.00	0.03	0.9	12000	0.025	0.02	0.9	10000	0.022
	16.00	0.02	0.9	10000	0.025	0.01	0.9	9200	0.022
	18.00	0.02	0.9	9200	0.022	0.01	0.9	8500	0.022
2.00	-	0.08	1	18000	0.028	0.06	1	15000	0.027
	4.00	0.08	1	18000	0.028	0.06	1	15000	0.027
	6.00	0.06	1	18000	0.025	0.05	1	15000	0.025
	8.00	0.05	1	16000	0.025	0.04	1	12000	0.025
	10.00	0.05	1	14000	0.025	0.04	1	12000	0.021
	12.00	0.04	1	12000	0.025	0.03	1	10000	0.025
	14.00	0.03	1	12000	0.025	0.02	1	10000	0.022
	16.00	0.03	1	10000	0.025	0.02	1	9200	0.022
	18.00	0.02	1	9200	0.022	0.01	1	8500	0.022
	20.00	0.02	1	9200	0.021	0.01	1	8500	0.020
	25.00	0.015	1	8500	0.019	0.008	1	8000	0.019
	30.00	0.01	1	7500	0.019	0.006	1	7000	0.018
	35.00	0.008	1	6500	0.018	0.005	1	6000	0.017
2.50	40.00	0.005	1	5500	0.016	0.004	1	5000	0.015
	50.00	0.004	1	4500	0.011	0.003	1	4000	0.010
	-	0.07	1.25	14000	0.029	0.05	1.25	10000	0.035
	8.00	0.07	1.25	14000	0.029	0.05	1.25	10000	0.035
	12.00	0.06	1.25	12000	0.029	0.04	1.25	9600	0.031
	16.00	0.05	1.25	10000	0.030	0.02	1.25	8500	0.029
	20.00	0.05	1.25	8200	0.030	0.02	1.25	7500	0.033
	30.00	0.025	1.25	7000	0.021	0.015	1.25	6000	0.021
3.00	40.00	0.012	1.25	5500	0.018	0.01	1.25	5000	0.018
	50.00	0.008	1.25	4500	0.013	0.005	1.25	4000	0.013
	-	0.1	1.5	14000	0.032	0.07	1.5	10000	0.040
	8.00	0.1	1.5	14000	0.032	0.07	1.5	10000	0.040
	12.00	0.08	1.5	12000	0.033	0.06	1.5	9200	0.038
	16.00	0.07	1.5	10000	0.035	0.05	1.5	8500	0.035
	20.00	0.07	1.5	9000	0.039	0.04	1.5	7800	0.038
25.00	0.06	1.5	8200	0.037	0.03	1.5	7000	0.036	
30.00	0.03	1.5	7000	0.043	0.02	1.5	6500	0.038	

ALU LINE - ENDMILL
SE 30
NITCo 30
OPTIMUM
SE 45
SE 45X
SE 45X
NITCo 45
SE 60
SE 60X
DM70 - SE 70
SE GR
TE 45
PLUNGE -MILL
THREAD MILL

Note: These recommended cutting data indicators are just for reference. They should be adjusted according to the different cutting condition

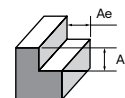

SE 70 Miniature Endmills With Long Neck, 4 Flutes - A5E

Side Milling		H							
Working Material		Hardened steel				Hardened steel			
Properties		45 ≤ HRC < 52				52 ≤ HRC < 68			
D	Effective Length	Ap	Ae	N	Fz	Ap	Ae	N	Fz
1	-	0.04	0.5	25300	0.043	0.03	0.5	18000	0.056
	4	0.04	0.5	25300	0.036	0.03	0.5	18000	0.044
	6	0.02	0.5	19800	0.035	0.01	0.5	14000	0.045
	8	0.02	0.5	17600	0.034	0.01	0.5	12000	0.044
	10	0.01	0.5	15400	0.032	0.007	0.5	10000	0.040
1.2	-	0.03	0.6	19800	0.045	0.02	0.6	14000	0.054
	6	0.03	0.6	19800	0.035	0.02	0.6	14000	0.043
	8	0.02	0.6	17600	0.034	0.01	0.6	12000	0.042
	10	0.02	0.6	13200	0.038	0.01	0.6	10000	0.043
	12	0.01	0.6	11000	0.045	0.007	0.6	9000	0.044
1.5	-	0.04	0.75	22000	0.048	0.03	0.75	18000	0.053
	6	0.04	0.75	22000	0.036	0.03	0.75	18000	0.039
	8	0.03	0.75	19800	0.033	0.03	0.75	14000	0.043
	10	0.03	0.75	17600	0.031	0.02	0.75	14000	0.036
	12	0.02	0.75	15400	0.032	0.02	0.75	12000	0.035
	14	0.02	0.75	13200	0.030	0.01	0.75	10000	0.038
1.8	16	0.01	0.75	11000	0.033	0.007	0.75	9000	0.033
	-	0.05	0.9	19800	0.053	0.04	0.9	15000	0.060
	6	0.05	0.9	19800	0.045	0.04	0.9	15000	0.050
	8	0.04	0.9	17600	0.045	0.03	0.9	12000	0.050
	10	0.04	0.9	15400	0.045	0.03	0.9	12000	0.042
	12	0.03	0.9	13200	0.045	0.02	0.9	10000	0.050
	14	0.03	0.9	13200	0.045	0.02	0.9	10000	0.043
2	16	0.02	0.9	11000	0.045	0.01	0.9	9200	0.043
	18	0.02	0.9	10120	0.041	0.01	0.9	8500	0.044
	-	0.06	1	19800	0.056	0.05	1	15000	0.060
	6	0.06	1	19800	0.045	0.05	1	15000	0.050
	8	0.05	1	17600	0.045	0.04	1	12000	0.054
	10	0.05	1	15400	0.045	0.04	1	12000	0.050
	12	0.04	1	13200	0.049	0.03	1	10000	0.055
	14	0.03	1	13200	0.045	0.02	1	10000	0.048
2.5	16	0.03	1	11000	0.045	0.02	1	9200	0.046
	18	0.02	1	10120	0.041	0.01	1	8500	0.044
	20	0.02	1	10120	0.038	0.01	1	8500	0.040
	-	0.07	1.25	15400	0.065	0.05	1.25	10000	0.088
	8	0.07	1.25	15400	0.052	0.05	1.25	10000	0.070
	12	0.06	1.25	13200	0.053	0.04	1.25	9600	0.063
3	16	0.05	1.25	11000	0.055	0.02	1.25	8500	0.059
	20	0.05	1.25	9020	0.055	0.02	1.25	7500	0.067
	25	0.03	1.25	7700	0.052	0.01	1.25	6500	0.052
	-	0.1	1.5	15400	0.065	0.07	1.5	10000	0.090
	8	0.1	1.5	15400	0.058	0.07	1.5	10000	0.080
	12	0.08	1.5	13200	0.061	0.06	1.5	9200	0.076
4	16	0.07	1.5	11000	0.068	0.05	1.5	8500	0.076
	20	0.07	1.5	9900	0.071	0.04	1.5	7800	0.077
	25	0.06	1.5	9020	0.072	0.03	1.5	7000	0.079
	30	0.03	1.5	7700	0.078	0.02	1.5	6500	0.077
	-	0.15	2	10450	0.110	0.08	2	8000	0.131
	12	0.15	2	10450	0.096	0.08	2	8000	0.100
	16	0.1	2	8800	0.085	0.06	2	7000	0.100
4	25	0.07	2	6600	0.106	0.04	2	5200	0.115
	30	0.05	2	5280	0.095	0.03	2	4200	0.101
	35	0.04	2	4620	0.095	0.02	2	3800	0.095
	40	0.03	2	3960	0.091	0.01	2	3000	0.100

cont'd ▶

ALL LINE
 EZ LINE -
 ENDMILL
 SE 30
 NITCO 30
 OPTIMUM
 SE 45
 SE 45X
 NITCO 45
 SE 60
 SE 60X
 DM70 -
 SE 70
 SE GR
 TE 45
 PLUNGE
 -MILL
 THREAD
 MILL

Note: These recommended cutting data indicators are just for reference. They should be adjusted according to the different cutting condition

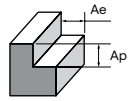

SE 70 Miniature Endmills With Long Neck, 4 Flutes - A5E

Side Milling		H							
Working Material		Hardened steel				Hardened steel			
Properties		45 ≤ HRC < 52				52 ≤ HRC < 68			
D	Effective Length	Ap	Ae	N	Fz	Ap	Ae	N	Fz
5	-	0.12	2.5	7700	0.149	0.08	2.5	5500	0.182
	16	0.12	2.5	7700	0.117	0.08	2.5	5500	0.145
	25	0.07	2.5	6380	0.110	0.05	2.5	4200	0.143
	35	0.05	2.5	4620	0.097	0.03	2.5	3500	0.114
	50	0.03	2.5	3080	0.101	0.02	2.5	2500	0.100
6	-	0.18	3	7150	0.147	0.08	3	4500	0.211
	20	0.18	3	7150	0.112	0.08	3	4500	0.156
	30	0.12	3	4950	0.121	0.06	3	3500	0.143
	40	0.08	3	3300	0.152	0.03	3	2500	0.160
	50	0.05	3	2750	0.127	0.02	3	2000	0.125

SE 70R Miniature Torus Endmills With Long Neck, 2 Flutes - A5G

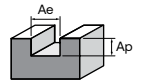

Slotting		H1			H2		
Working Material		Hardened steel			Hardened steel		
Properties		45 ≤ HRC < 52			45 ≤ HRC < 52		
D	Effective Length	Ap	N	Fz	Ap	N	Fz
0.2	-	0.003	30,000	0.003	0.003	30,000	0.001
	0.5	0.003	30,000	0.003	0.003	30,000	0.001
	1	0.003	30,000	0.002	0.002	30,000	0.001
	1.5	0.002	30,000	0.001	0.002	30,000	0.001
	2	0.002	30,000	0.001	0.001	30,000	0.001
0.3	-	0.003	30,000	0.007	0.003	30,000	0.005
	1	0.003	30,000	0.005	0.003	30,000	0.004
	1.5	0.003	30,000	0.003	0.003	30,000	0.003
	2	0.003	30,000	0.002	0.003	30,000	0.002
	2.5	0.002	25,000	0.002	0.002	25,000	0.001
0.4	3	0.002	25,000	0.001	0.002	25,000	0.001
	-	0.005	30,000	0.007	0.005	28,000	0.006
	1	0.005	30,000	0.006	0.005	28,000	0.005
	1.5	0.005	30,000	0.006	0.005	28,000	0.005
	2	0.005	30,000	0.005	0.005	25,000	0.005
0.5	2.5	0.004	28,000	0.005	0.004	25,000	0.005
	3	0.004	25,000	0.005	0.003	23,000	0.004
	4	0.003	25,000	0.004	0.002	20,000	0.004
	-	0.008	25,000	0.011	0.006	23,000	0.011
	1	0.008	25,000	0.010	0.006	23,000	0.009
0.6	2	0.007	25,000	0.008	0.005	23,000	0.008
	3	0.006	25,000	0.007	0.004	23,000	0.007
	4	0.004	25,000	0.006	0.002	23,000	0.005
	5	0.003	20,000	0.006	0.002	18,000	0.005
	6	0.002	20,000	0.005	0.001	18,000	0.004
0.6	-	0.012	25,000	0.012	0.006	23,000	0.010
	2	0.012	25,000	0.010	0.006	23,000	0.008
	4	0.007	23,000	0.009	0.004	20,000	0.007
	6	0.005	20,000	0.007	0.003	18,000	0.005
	8	0.003	16,000	0.006	0.001	14,000	0.003
	10	0.001	14,000	0.003	0.001	12,000	0.003

cont'd ▶

ALU LINE - ENDMILL
 SE 30
 NITCo 30
 OPTIMUM
 SE 45
 SE 45X
 NITCo 45
 SE 60
 SE 60X
 DM70 - SE 70
 SE GR
 TE 45
 PLUNGE -MILL
 THREAD MILL

Note: These recommended cutting data indicators are just for reference. They should be adjusted according to the different cutting condition



SE 70R Miniature Torus Endmills With Long Neck, 2 Flutes - A5G

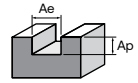

Slotting		H1			H2		
Working Material		Hardened steel			Hardened steel		
Properties		45 ≤ HRC < 52			45 ≤ HRC < 52		
D	Effective Length	Ap	N	Fz	Ap	N	Fz
0.7	-	0.012	25,000	0.013	0.006	23,000	0.011
	2	0.012	25,000	0.012	0.006	23,000	0.009
	4	0.008	25,000	0.010	0.005	23,000	0.008
	6	0.005	20,000	0.010	0.003	18,000	0.008
0.8	-	0.030	25,000	0.020	0.020	23,000	0.019
	2	0.030	25,000	0.017	0.020	23,000	0.016
	4	0.025	25,000	0.014	0.015	23,000	0.013
	6	0.020	20,000	0.013	0.010	18,000	0.012
	8	0.010	16,000	0.012	0.005	14,000	0.010
0.9	12	0.005	14,000	0.014	0.003	12,000	0.012
	-	0.030	25,000	0.017	0.020	20,000	0.018
	4	0.030	25,000	0.014	0.020	20,000	0.014
	8	0.010	16,000	0.015	0.008	14,000	0.013

SE 70R Miniature Torus Endmills With Long Neck, 4 Flutes - A5G

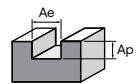

Slotting		H1			H2		
Working Material		Hardened steel			Hardened steel		
Properties		45 ≤ HRC < 52			45 ≤ HRC < 52		
D	Effective Length	Ap	N	Fz	Ap	N	Fz
1	-	0.050	25000	0.023	0.040	21,000	0.025
	2	0.050	25000	0.020	0.040	21,000	0.021
	3	0.050	23000	0.021	0.040	20,000	0.022
	4	0.040	21000	0.021	0.030	18,000	0.022
	5	0.030	19000	0.021	0.020	16,000	0.022
	6	0.020	16000	0.024	0.010	14,000	0.023
	8	0.015	15000	0.020	0.008	13,000	0.020
	10	0.010	13000	0.018	0.006	11,000	0.018
	12	0.010	11000	0.020	0.006	9,000	0.020
1.2	-	0.045	20,000	0.023	0.030	17,000	0.022
	5	0.045	20,000	0.017	0.030	17,000	0.017
	10	0.030	13,000	0.018	0.010	11,000	0.019
1.5	-	0.050	23000	0.023	0.040	20,000	0.024
	3	0.050	23000	0.020	0.040	20,000	0.021
	4	0.050	21000	0.021	0.040	18,000	0.021
	6	0.045	19000	0.021	0.030	16,000	0.021
	8	0.040	16000	0.021	0.025	14,000	0.021
	10	0.035	14500	0.019	0.023	12,500	0.021
	12	0.030	13000	0.018	0.020	11,000	0.019
	15	0.020	11000	0.015	0.007	9,000	0.015
2	-	0.060	20000	0.028	0.050	17,000	0.026
	4	0.060	20000	0.024	0.050	17,000	0.023
	6	0.060	18000	0.025	0.050	15,000	0.025
	8	0.050	16000	0.025	0.040	14,000	0.024
	10	0.045	14500	0.025	0.035	12,500	0.025
	12	0.040	13000	0.026	0.030	11,000	0.025
	16	0.030	11000	0.024	0.020	9,500	0.023
	20	0.020	8000	0.023	0.010	7,000	0.024

cont'd ▶

ALL LINE
EZ LINE -
ENDMILL
SE 30
NITCO 30
OPTIMUM
SE 45
SE 45X
NITCO 45
SE 60
SE 60X
DM70 -
SE 70
SE GR
TE 45
PLUNGE
-MILL
THREAD
MILL

Note: These recommended cutting data indicators are just for reference. They should be adjusted according to the different cutting condition



ALU LINE
EZ LINE - ENDMILL
SE 30
NITCo 30
OPTIMUM
SE 45
SE 45X
NITCo 45
SE 60
SE 60X
DM70 - SE 70
SE GR
TE 45
PLUNGE -MILL
THREAD MILL

SE 70R Miniature Torus Endmills With Long Neck, 4 Flutes - A5G

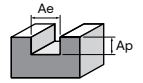

Slotting		H1			H2		
Working Material		Hardened steel			Hardened steel		
Properties		45 ≤ HRC < 52			45 ≤ HRC < 52		
D	Effective Length	Ap	N	Fz	Ap	N	Fz
2.5	-	0.070	15,000	0.033	0.050	11,000	0.040
	10	0.070	13,000	0.030	0.050	11,000	0.032
	20	0.040	9000	0.028	0.020	7,500	0.033
	30	0.010	5500	0.027	0.010	4,500	0.033
3	-	0.100	15000	0.034	0.070	13,000	0.035
	4	0.100	15000	0.032	0.070	13,000	0.032
	6	0.100	13000	0.036	0.070	11,000	0.037
	8	0.100	11000	0.041	0.070	9,500	0.042
	10	0.090	11000	0.039	0.065	9,500	0.040
	12	0.080	11000	0.038	0.060	9,500	0.039
	16	0.070	10000	0.039	0.050	8,500	0.040
	18	0.060	9000	0.042	0.045	7,500	0.043
	20	0.050	8000	0.045	0.040	7,000	0.045
	25	0.040	7500	0.044	0.020	6,500	0.043
4	30	0.030	6500	0.045	0.020	5,500	0.045
	-	0.150	10000	0.059	0.080	8,500	0.064
	8	0.150	10000	0.049	0.080	8,500	0.053
	12	0.150	10000	0.043	0.080	8,500	0.047
	16	0.100	8000	0.048	0.060	7,000	0.050
5	24	0.080	6500	0.043	0.050	5,500	0.045
	32	0.040	5500	0.032	0.020	4,500	0.033
	-	0.150	8,000	0.073	0.080	7,000	0.074
	15	0.150	8,000	0.056	0.080	7,000	0.057
6	20	0.100	6500	0.062	0.070	5,500	0.065
	40	0.050	4,000	0.056	0.020	3,500	0.057
	-	0.180	6500	0.082	0.080	5,500	0.087
	12	0.180	6500	0.068	0.080	5,500	0.071
	18	0.180	5,500	0.072	0.080	4,500	0.077
6	24	0.150	5000	0.070	0.070	4,000	0.076
	48	0.050	2,500	0.070	0.030	2,000	0.062

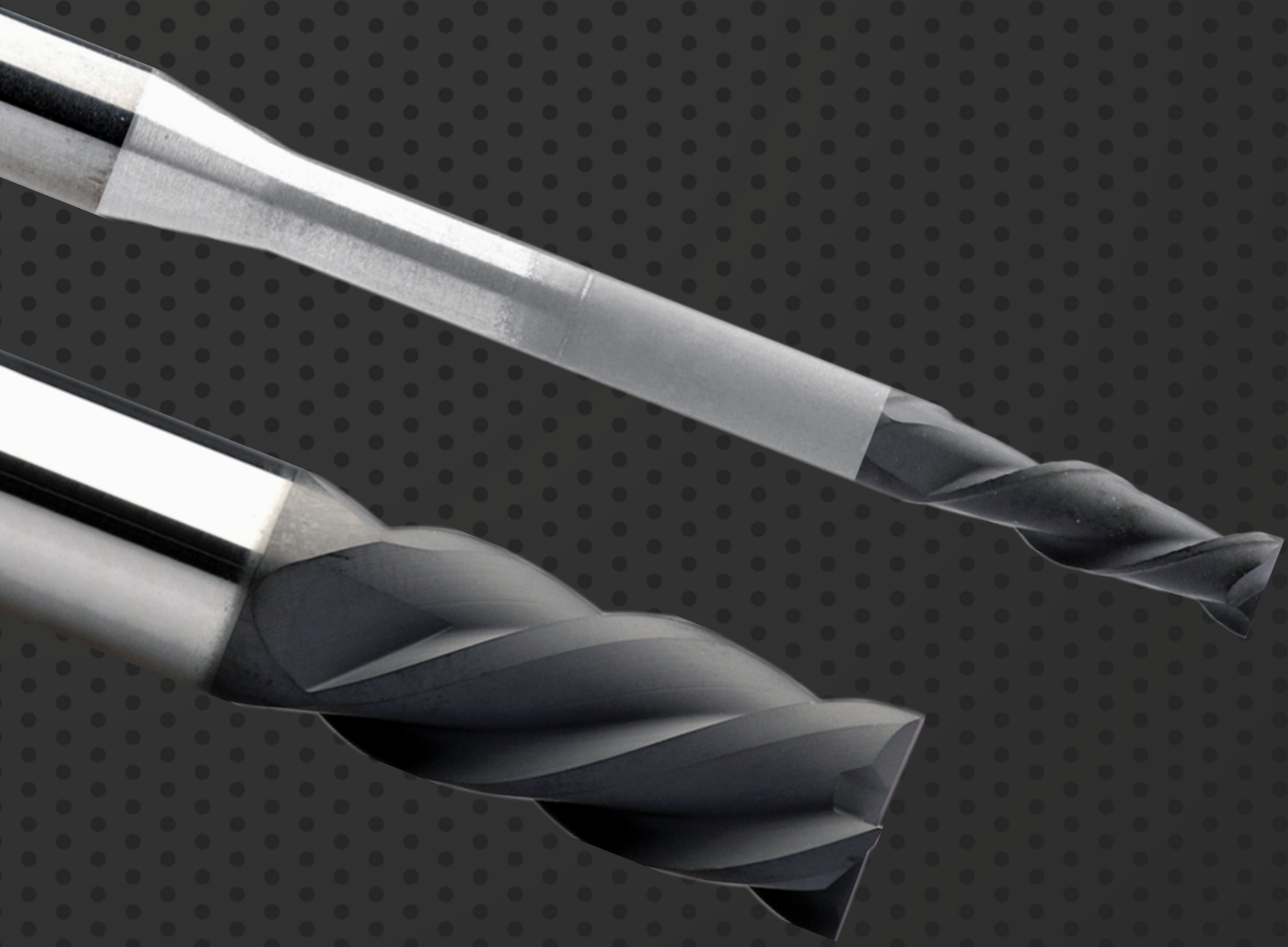

ENDMILLS





SE GR

Diamond coated end mills special for machining graphite and composite reinforced plastic fiber glass (CRP)

Index - SE GR, For Thermoplastic & Graphite



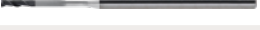
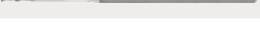

 Suitable for Material Groups
  Adapté pour les matériaux
  适用于材料
 Geeignet für die Materialgruppen
  Adatto per il materiale



EDP Number	Type	No. Z	Helix Angle	Coating	Performance	Page Number
750	 SE GR	4	40°	DCT01	G	328
752	 SE GR Miniature Long Neck	2	40°	DCT01	G	329
753	 SE GR Miniature Long Neck	4	40°	DCT01	G	330
J86	 SE GR Torus Miniature Long Neck	2	40°	DCT01	G	331
H86	 SE GR Torus Miniature Long Neck	4	40°	DCT01	G	332

G - General P - Performance

SE GR ENDMILLS, 4 FLUTES

-  VHM SE GR Fräser, 4 Zähne, DIAMANT bzw. DLC beschichtet zur Bearbeitung von Grafit
-  Frese SE GR, 4 taglienti, diamantate per lavorazioni in grafite
-  Fraises SE GR, 4 dents, diamanté pour usinage de graphite
-  整体硬质合金 SE GR 系列 DLC 钻石涂层加工石墨2刃平底铣刀

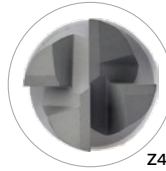
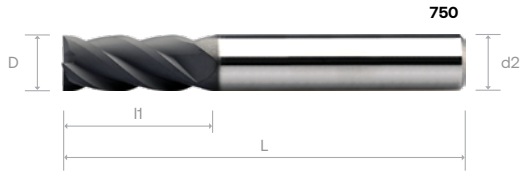

Order Number	Dimension (mm)					DCT01
	D	I1	I2	L	d2 (h6)	
750 0100 040 03	1	3		40	3	◦
750 0150 040 03	1.5	4.5		40	3	•
750 0200 040 03	2	6.5		40	3	◦
750 0250 040 03	2.5	6.5		40	3	•
750 0300	3	9		40	3	•
750 0400	4	12		50	4	•
750 0500	5	15		50	5	•
750 0600	6	20		60	6	•
750 0800	8		64	8	•	
750 1000	10	22		70	10	•
750 1200	12	25		75	12	•

ALU LINE

EZ LINE -
ENDMILL

SE 30

NITCO 30

OPTIMUM

SE 45

SE 45X

NITCO 45

SE 60

SE 60X

DM70 -
SE 70

SE GR

TE 45

PLUNGE
-MILL

THREAD
MILL

Material Group | Material-Gruppe | Groupe Matiere | Gruppo Materiali | 材质主类

Cutting Parameter

N01 N02 N03 K01 K02 P01 P02 P03 M01 M02 S01 S02 S03 H01 H02 O01 O02

333

SE GR MINIATURE ENDMILLS WITH LONG NECK, 2 FLUTES

VHM SE GR Fräser mit langem Hals, 2 Zähne, DIAMANT bzw. DLC beschichtet, zur Bearbeitung von Grafit

Frese SE GR, con collo lungo, 2 taglienti, diamantate per lavorazioni in grafite

Fraises SE GR, 4 dents, diamanté pour usinage de graphite

整体硬质合金 SE GR 系列 DLC 钻石涂层加工石墨 2 刃长颈平底铣刀

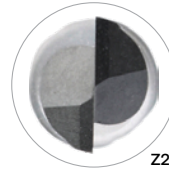

Order Number	Dimension (mm)						DCT01
	D	l1	l2	L	d1	d2 (h6)	
752 0050 050 03	0.5	1	6	50	0.45	3	°
752 0060 050 03	0.6	1.2	6	50	0.55	3	°
752 0080 050 03	0.8	1.6	8	50	0.75	3	°
752 0100 060 03	1	3	10	60	0.9	3	°
752 0100 060 04		3	10	60	0.9	4	•
752 0200 060 04	2	6.5	20	60	1.9	4	•
752 0300 075 03	3	9	30	75	2.8	3	•
752 0300 075 06			30	75	2.8	6	°
752 0400 100 04	4	25	40	100	3.7	4	°
752 0600	6		60	100	5.5	6	°

Material Group | Material-Gruppe | Groupe Matière | Gruppo Materiali | 材质主类

Cutting Parameter

N01	N02	N03	K01	K02	P01	P02	P03	M01	M02	S01	S02	S03	H01	H02	O01	O02	333
-----	-----	-----	-----	-----	-----	-----	-----	-----	-----	-----	-----	-----	-----	-----	-----	-----	-----

SE GR MINIATURE ENDMILLS WITH LONG NECK, 4 FLUTES

VHM SE GR Fräser mit langem Hals, 4 Zähne, DIAMANT bzw. DLC beschichtet, zur Bearbeitung von Grafit

Frese SE GR, con collo lungo, 4 taglienti, diamantate per lavorazioni in grafite

Frese SE GR, con collo lungo, 4 taglienti, diamantate per lavorazioni in grafite

整体硬质合金 SE GR 系列 DLC 钻石涂层加工石墨 4 刃长颈平底铣刀

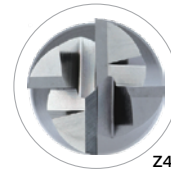

Order Number	Dimension (mm)						DCT01		
	D	l1	l2	L	d1	d2 (h6)			
753 0100 060 0300 100	1	3	10	60	0.9	3	○		
753 0100 060 0300 120			12	60	0.9	3	○		
753 0100 060 0300 160			16	60	0.9	3	○		
753 0100 060 0400 100			10	60	0.9	4	●		
753 0100 060 0400 120			12	60	0.9	4	○		
753 0100 060 0400 160			16	60	0.9	4	●		
753 0150 060 0300 100	1.5	4.5	10	60	1.4	3	●		
753 0150 060 0300 160			16	60	1.4	3	○		
753 0150 060 0300 180			18	60	1.4	3	○		
753 0150 060 0400 100			10	60	1.4	4	●		
753 0150 060 0400 160			16	60	1.4	4	●		
753 0150 060 0400 180			18	60	1.4	4	○		
753 0200 060 0300 100	2	6.5	10	60	1.9	3	○		
753 0200 060 0300 160			16	60	1.9	3	●		
753 0200 060 0300 200			20	60	1.9	3	○		
753 0200 060 0400 100			10	60	1.9	4	●		
753 0200 060 0400 160			16	60	1.9	4	●		
753 0200 060 0400 200			20	60	1.9	4	●		
753 0300 075 0300 150	3	9	15	75	2.8	3	●		
753 0300 075 0300 300			30	75	2.8	3	○		
753 0300 075 0400 150			15	75	2.8	4	○		
753 0300 075 0400 300			30	75	2.8	4	○		
753 0400 075 0400 200			20	75	3.7	4	●		
753 0400 075 0400 320			32	75	3.7	4	○		
753 0400 100 0400 250	4	15	25	100	3.7	4	○		
753 0400 100 0400 320			32	100	3.7	4	○		
753 0600 075 0600 400			40	75	5.5	6	●		
753 0600 100 0600 400			40	100	5.5	6	●		
753 0800 100 0800 400			40	100	7.4	8	●		
753 0800 150 0800 400			40	150	7.4	8	○		
753 1000 100 1000 400	10	25	40	100	9.2	10	●		
753 1000 150 1000 400			40	150	9.2	10	○		
753 1200 100 1200 400			40	100	11	12	○		
753 1200 150 1200 400			40	150	11	12	○		
753 1200 100 1200 400			12	25	40	100	11	12	○
753 1200 150 1200 400					40	150	11	12	○

ALU LINE
 EZ LINE - ENDMILL
 SE 30
 NITICO 30
 OPTIMUM
 SE 45
 SE 45X
 NITICO 45
 SE 60
 SE 60X
 DN70 - SE70
SE GR
 TE 45
 PLUNGE -MILL
 THREAD MILL

Material Group | Material-Gruppe | Groupe Matière | Gruppo Materiali | 材质主类

Cutting Parameter

N01	N02	N03	K01	K02	P01	P02	P03	M01	M02	S01	S02	S03	H01	H02	O01	O02
-----	-----	-----	-----	-----	-----	-----	-----	-----	-----	-----	-----	-----	-----	-----	-----	-----

333

SE GR TORUS MINIATURE ENDMILLS WITH LONG NECK, 2 FLUTES

VHM SE GR Torusfräser mit langem Hals, 2 Zähne, DIAMANT bzw. DLC beschichtet, zur Bearbeitung von Grafit

Frese toroidali SE GR, con collo lungo, 2 taglienti, diamantate per lavorazioni in grafite

Fraises SE GR toriques avec cou long longues, 2 dents, diamanté pour usinage de graphite

整体硬质合金 SE GR 系列 DLC 钻石涂层加工石墨 2 刃长颈平底铣刀

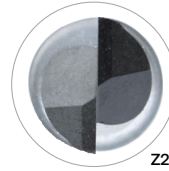

Order Number	Dimension (mm)							DCT01
	D	l1	l2	L	d1	d2 (h6)	R	
J86 0050 050 0300 060	0.5	1	6	50	0.45	3	0.05	°
J86 0050 050 0400 060			6	50	0.45	4	0.05	°
J86 0060 050 0400 060	0.6	1.2	6	50	0.55	4	0.05	°
J86 0080 050 0300 080	0.8	1.6	8	50	0.75	3	0.05	°
J86 0080 050 0400 080			8	50	0.75	4	0.05	°
J86 0080 050 0300 150			15	50	0.75	3	0.05	°
J86 0080 050 0400 150			15	50	0.75	4	0.05	°

ALU LINE
EZ LINE - ENDMILL
SE 30
NITCo 30
OPTIMUM
SE 45
SE 45X
NITCo 45
SE 60
SE 60X
DM70 - SE70
SE GR
TE 45
PLUNGE -MILL
THREAD MILL

Material Group | Material-Gruppe | Groupe Matière | Gruppo Materiali | 材质主类

Cutting Parameter

N01	N02	N03	K01	K02	P01	P02	P03	M01	M02	S01	S02	S03	H01	H02	O01	O02	333
-----	-----	-----	-----	-----	-----	-----	-----	-----	-----	-----	-----	-----	-----	-----	-----	-----	-----

SE GR TORUS MINIATURE ENDMILLS WITH LONG NECK, 4 FLUTES

VHM SE GR Torusfräser mit langem Hals, 4 Zähne, DIAMANT bzw. DLC beschichtet, zur Bearbeitung von Grafit

Frese toroidali SE GR, con collo lungo, 4 taglienti, diamantate per lavorazioni in grafite

Fraises SE GR toriques avec cou long longues, 4 dents, diamanté pour usinage de graphite

整体硬质合金 SE GR 系列 DLC 钻石涂层加工石墨4刃长颈平底铣刀

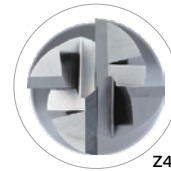

Order Number	Dimension (mm)							DCT01		
	D	l1	l2	L	d1	d2 (h6)	R			
H86 0100 060 0300 100 R005	1	3	10	60	0.9	3	0.05	°		
H86 0100 060 0400 100 R005			10	60	0.9	4	0.05	°		
H86 0100 060 0300 150 R005			15	60	0.9	3	0.05	°		
H86 0100 060 0400 150 R005			15	60	0.9	4	0.05	°		
H86 0100 060 0300 100 R010			10	60	0.9	3	0.1	°		
H86 0100 060 0400 100 R010			10	60	0.9	4	0.1	°		
H86 0100 060 0300 150 R010			15	60	0.9	3	0.1	°		
H86 0100 060 0400 150 R010			15	60	0.9	4	0.1	°		
H86 0150 060 0300 100 R005			1.5	4.5	10	60	1.4	3	0.05	°
H86 0150 060 0400 100 R005					10	60	1.4	4	0.05	°
H86 0150 060 0300 150 R005	15	60			1.4	3	0.05	°		
H86 0150 060 0400 150 R005	15	60			1.4	4	0.05	°		
H86 0150 060 0300 100 R010	10	60			1.4	3	0.1	°		
H86 0150 060 0400 100 R010	10	60			1.4	4	0.1	°		
H86 0150 060 0300 150 R010	15	60			1.4	3	0.1	°		
H86 0150 060 0400 150 R010	15	60			1.4	4	0.1	°		
H86 0200 060 0300 200 R005	2	6.5			20	60	1.9	3	0.05	°
H86 0200 060 0400 200 R005					20	60	1.9	4	0.05	°
H86 0200 060 0300 300 R005			30	60	1.9	3	0.05	°		
H86 0200 060 0400 300 R005			30	60	1.9	4	0.05	°		
H86 0200 060 0300 200 R010			20	60	1.9	3	0.1	°		
H86 0200 060 0400 200 R010			20	60	1.9	4	0.1	°		
H86 0200 060 0300 300 R010			30	60	1.9	3	0.1	°		
H86 0200 060 0400 300 R010			30	60	1.9	4	0.1	°		
H86 0300 060 0300 200 R020			3	9	20	60	2.8	3	0.2	°
H86 0300 060 0400 200 R020					20	60	2.8	4	0.2	°
H86 0300 075 0300 150 R020	15	75			2.8	3	0.2	°		
H86 0300 075 0300 150 R050	15	75			2.8	3	0.5	•		
H86 0300 075 0300 150 R020	15	75			2.8	4	0.2	°		
H86 0300 075 0300 150 R050	15	75			2.8	4	0.5	•		
H86 0300 075 0300 300 R020	30	75			2.8	3	0.2	°		
H86 0300 075 0300 300 R050	30	75			2.8	3	0.5	°		
H86 0300 075 0400 300 R020	30	75			2.8	4	0.2	°		
H86 0300 075 0400 300 R050	30	75			2.8	4	0.5	°		
H86 0400 060 0400 200 R030	4	12	30	60	3.7	4	0.3	°		
H86 0400 075 0400 320 R020			32	75	3.7	4	0.2	°		
H86 0400 075 0400 320 R030			32	75	3.7	4	0.3	°		
H86 0400 075 0400 320 R050			32	75	3.7	4	0.5	•		
H86 0400 100 0400 400 R020			40	100	3.7	4	0.2	°		
H86 0400 100 0400 400 R030		40	100	3.7	4	0.3	°			
H86 0400 100 0400 400 R050		40	100	3.7	4	0.5	°			
H86 0600 075 0600 400 R030		6	25	40	75	5.5	6	0.3	°	
H86 0600 075 0600 400 R050				40	75	5.5	6	0.5	°	
H86 0600 100 0600 400 R030				40	100	5.5	6	0.3	•	
H86 0600 100 0600 400 R050	40			100	5.5	6	0.5	•		
H86 0800 100 0800 400 R050	40			100	7.4	8	0.5	•		
H86 0800 150 0800 400 R050	8	150	7.4	8	0.5	°				
H86 1000 100 1000 400 R050	10	40	100	9.8	10	0.5	•			
H86 1000 150 1000 400 R050		40	150	9.8	10	0.5	°			
H86 1200 100 1200 400 R050	12	40	100	11	12	0.5	°			
H86 1200 150 1200 400 R050		40	150	11	12	0.5	°			

ALL LINE
 EZ LINE - ENDMILL
 SE 30
 NITICO 30
 OPTIMUM
 SE 45
 SE 45X
 NITICO 45
 SE 60
 SE 60X
 DN70 - SE70
 SE GR
 TE 45
 PLUNGE -MILL
 THREAD MILL

Material Group | Material-Gruppe | Groupe Matiere | Gruppo Materiali | 材质主类

Cutting Parameter

N01	N02	N03	K01	K02	P01	P02	P03	M01	M02	S01	S02	S03	H01	H02	O01	O02
-----	-----	-----	-----	-----	-----	-----	-----	-----	-----	-----	-----	-----	-----	-----	-----	-----

333

Note: These recommended cutting data indicators are just for reference. They should be adjusted according to the different cutting condition



SE GR Endmills, 4 Flutes - 750

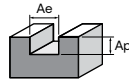

Slotting		
Working Material	Graphite	
Properties	-	
Cutting depth, ap	0.25 × D	
Cutting Width, ae	1.00 × D	
D	Vc	Fz
1	200	0.002
2		0.005
3		0.009
4		0.014
5		0.019
6		0.024
8		0.035
10		0.045
12		0.057

SE GR Endmills, 4 Flutes - 750

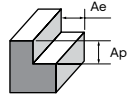

Side Milling		
Working Material	Graphite	
Properties	-	
Cutting depth, ap	1.00 × D	
Cutting Width, ae	0.40 × D	
D	Vc	Fz
1	230	0.003
2		0.007
3		0.011
4		0.016
5		0.021
6		0.027
8		0.037
10		0.050
12		0.069

SE GR Miniature Endmills With Long Neck, 2 Flutes - 752, J86

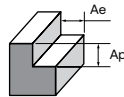

Side Milling		
Working Material	Graphite	
Properties	-	
Cutting depth, ap	0.25 × D	
Cutting Width, ae	1.00 × D	
D	Vc	Fz
1	150	0.005
2		0.013
3		0.022
4		0.032
6		0.051

SE GR Miniature Endmills With Long Neck, 4 Flutes - 753, H86

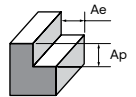

Side Milling		
Working Material	Graphite	
Properties	-	
Cutting depth, ap	1.00 × D	
Cutting Width, ae	0.40 × D	
D	Vc	Fz
1	160	0.005
2		0.013
3		0.022
4		0.033
6		0.052
8		0.075
10		0.096
12		0.121

ALU LINE
ENDMILL
SE 30
SE 30
NITCo 30
OPTIMUM
SE 45
SE 45X
NITCo 45
SE 60
SE 60X
DM70 - SE70
SE GR
TE 45
PLUNGE -MILL
THREAD MILL



ENDMILLS

TE 45

For material application ≤ 45 HRC

Index - TE 45, For ≤ 45 HRC

 Suitable for Material Groups

 Adapté pour les matériaux





















 适用于材料

P

K

H

 Geeignet für die Materialgruppen  Adatto per il materiale

EDP Number	Type	No. Z	Helix Angle	Coating	Performance	Page Number
583 	TE 45 0.5° inclination	3/4	40°	UC	G	336
B37 	TE 45 0.5° inclination	3/4	40°	B0819	G	336
587 	TE 45 1.0° inclination	3/4	40°	UC	G	337
B38 	TE 45 1.0° inclination	3/4	40°	B0819	G	337
591 	TE 45 1.5° inclination	3/4	40°	UC	G	338
B39 	TE 45 1.5° inclination	3/4	40°	B0819	G	338
595 	TE 45 2.0° inclination	3/4	40°	UC	G	339
B40 	TE 45 2.0° inclination	3/4	40°	B0819	G	339
599 	TE 45 2.5° inclination	3/4	40°	UC	G	340
B41 	TE 45 2.5° inclination	3/4	40°	B0819	G	340
603 	TE 45 3.0° inclination	3/4	40°	UC	G	341
B42 	TE 45 3.0° inclination	3/4	40°	B0819	G	341
607 	TE 45 4.0° inclination	3/4	40°	UC	G	342
B43 	TE 45 4.0° inclination	3/4	40°	B0819	G	342
611 	TE 45 5.0° inclination	3/4	40°	UC	G	343
B44 	TE 45 5.0° inclination	3/4	40°	B0819	G	343
615 	TE 45 7.0° inclination	3/4	40°	UC	G	344
B45 	TE 45 7.0° inclination	3/4	40°	B0819	G	344
618 	TE 45 10.0° inclination	3	40°	UC	G	345
B46 	TE 45 10.0° inclination	3	40°	B0819	G	345

G - General P - Performance

TE 45 DIE-SINKING CUTTERS WITH 0.5° INCLINATION, 3 - 4 FLUTES

- VHM TE 45 Gesenkräuser, kegelig mit einem Winkel von 0.5° - 3 bzw. 4 Zähne
- Frese conica per stampi TE 45 con angolo di 0.5°, 3 - 4 taglienti
- Fraises coniques TE 45 pour matrices avec 0.5° d'inclinaison, 3 ou 4 dents suivant Ø
- 整体硬质合金 TE 45 系列 锥形铣刀3/4刃-锥度0.5°

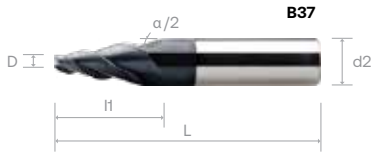
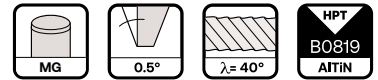

Order Number	Dimension (mm)						UC	Order Number	Dimension (mm)						B0819	
	D	I1	I2	L	d2 (h6)	Z			D	I1	I2	L	d2 (h6)	Z		
583 0050 040 0300 02	0.5	2		40	3	3	°	B37 0050 040 0300 02	0.5	2		40	3	3	°	
583 0060 040 0300 03	0.6			40	3	3	°	B37 0060 040 0300 03	0.6			40	3	3	°	
583 0080 040 0300 03	0.8	3		40	3	3	°	B37 0080 040 0300 03	0.8	3		40	3	3	°	
583 0100 050 0400 04	1	4		50	4	3	°	B37 0100 050 0400 04	1	4		50	4	3	°	
583 0150 050 0400 05	1.5	5		50	4	3	°	B37 0150 050 0400 05	1.5	5		50	4	3	°	
583 0200 050 0400 06	2	6		50	4	3	°	B37 0200 050 0400 06	2	6		50	4	3	°	
583 0250 050 0400 08		8		50	4	3	°	B37 0250 050 0400 08		8		50	4	3	°	
583 0250 040 0300 10	2.5			40	3	3	°	B37 0250 040 0300 10	2.5			40	3	3	°	
583 0250 060 0300 20		20		60	3	3	°	B37 0250 060 0300 20		20		60	3	3	°	
583 0300 050 0600 10				50	6	3	°	B37 0300 050 0600 10				50	6	3	°	
583 0300 060 0400 20	3			60	4	3	°	B37 0300 060 0400 20	3			60	4	3	°	
583 0300 060 0400 30		30		60	4	3	°	B37 0300 060 0400 30		30		60	4	3	°	
583 0350 060 0400 20	3.5	20		60	4	3	°	B37 0350 060 0400 20	3.5	20		60	4	3	°	
583 0400 050 0600 15		15		50	6	3	°	B37 0400 050 0600 15		15		50	6	3	°	
583 0400 060 0500 20	4	20		60	5	3	°	B37 0400 060 0500 20	4	20		60	5	3	°	
583 0400 075 0500 30		30		75	5	3	°	B37 0400 075 0500 30		30		75	5	3	°	
583 0500 060 0600 20		20		60	6	3	°	B37 0500 060 0600 20		20		60	6	3	°	
583 0500 075 0600 30	5	30		75	6	3	°	B37 0500 075 0600 30	5	30		75	6	3	°	
583 0500 100 0600 50		50		100	6	3	°	B37 0500 100 0600 50		50		100	6	3	°	
583 0600 064 0800 20		20		64	8	3	°	B37 0600 064 0800 20		20		64	8	3	°	
583 0600 075 0800 30	6	30		75	8	3	°	B37 0600 075 0800 30	6	30		75	8	3	°	
583 0600 100 0800 60		60		100	8	3	°	B37 0600 100 0800 60		60		100	8	3	°	
583 0800 070 1000 25		25		70	10	4	°	B37 0800 070 1000 25		25		70	10	4	°	
583 0800 075 1000 30	8	30		75	10	4	°	B37 0800 075 1000 30	8	30		75	10	4	°	
583 0800 100 1000 60		60		100	10	4	°	B37 0800 100 1000 60		60		100	10	4	°	
583 1000 075 1200 30	10			75	12	4	°	B37 1000 075 1200 30	10			75	12	4	°	
583 1200 075 1400 30		30		75	14	4	°	B37 1200 075 1400 30		30		75	14	4	°	
583 1200 100 1400 50	12			100	14	4	°	B37 1200 100 1400 50	12			100	14	4	°	
583 1600 100 1800 60	16	60		100	18	4	°	B37 1600 100 1800 60	16	60		100	18	4	°	

ALL LINE
EZ LINE - ENDMILL
SE 30
NITICO 30
OPTIMUM
SE 45
SE 45X
NITICO 45
SE 60
SE 60X
DN70 - SE 70
SE GR
TE 45
PLUNGE -MILL
THREAD MILL

Material Group | Material-Gruppe | Groupe Matière | Gruppo Materiali | 材质主类

Cutting Parameter

N01	N02	N03	K01	K02	P01	P02	P03	M01	M02	S01	S02	S03	H01	H02	O01	O02
-----	-----	-----	-----	-----	-----	-----	-----	-----	-----	-----	-----	-----	-----	-----	-----	-----

346

TE 45 DIE-SINKING CUTTERS WITH 1.0° INCLINATION, 3 - 4 FLUTES

- VHM TE 45 Gesenkfräser, kegelig mit einem Winkel von 1.0° - 3 bzw. 4 Zähne
- Frese conica per stampi TE 45 con angolo di 1.0°, 3 - 4 taglienti
- Fraises coniques TE 45 pour matrices avec 1.0° d'inclinaison, 3 ou 4 dents suivant Ø
- 整体硬质合金 TE 45 系列 锥形铣刀3/4刀-锥度1.0°

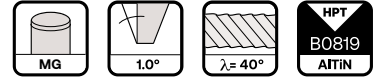

Order Number	Dimension (mm)						UC	Order Number	Dimension (mm)						B0819	
	D	I1	I2	L	d2 (h6)	Z			D	I1	I2	L	d2 (h6)	Z		
587 0050 040 0300 02	0.5	2		40	3	3	°	B38 0050 040 0300 02	0.5	2		40	3	3	°	
587 0060 040 0300 03	0.6			40	3	3	°	B38 0060 040 0300 03	0.6	3		40	3	3	°	
587 0080 040 0300 03	0.8	3		40	3	3	°	B38 0080 040 0300 03	0.8	3		40	3	3	°	
587 0100 050 0400 04	1	4		50	4	3	°	B38 0100 050 0400 04	1	4		50	4	3	°	
587 0150 050 0400 05	1.5	5		50	4	3	°	B38 0150 050 0400 05	1.5	5		50	4	3	°	
587 0200 050 0400 06	2	6		50	4	3	°	B38 0200 050 0400 06	2	6		50	4	3	°	
587 0250 050 0400 08		8		50	4	3	°	B38 0250 050 0400 08		8		50	4	3	°	
587 0250 060 0400 20	2.5	20		60	4	3	°	B38 0250 060 0400 20	2.5	20		60	4	3	•	
587 0300 050 0600 10		10		50	6	3	°	B38 0300 050 0600 10		10		50	6	3	°	
587 0300 060 0400 20	3	20		60	4	3	°	B38 0300 060 0400 20	3	20		60	4	3	•	
587 0300 075 0500 40		40		75	5	3	°	B38 0300 075 0500 40		40		75	5	3	°	
587 0350 060 0500 20	3.5	20		60	5	3	°	B38 0350 060 0500 20	3.5	20		60	5	3	•	
587 0400 050 0600 15		15		50	6	3	°	B38 0400 050 0600 15		15		50	6	3	°	
587 0400 065 0500 20	4	20		65	5	3	°	B38 0400 065 0500 20	4	20		65	5	3	°	
587 0500 060 0600 20		20		60	6	3	°	B38 0500 060 0600 20		20		60	6	3	•	
587 0500 100 0800 55	5	55		100	8	3	°	B38 0500 100 0800 55	5	55		100	8	3	°	
587 0600 064 0800 20		20		64	8	3	°	B38 0600 064 0800 20		20		64	8	3	°	
587 0600 075 0800 30	6	30		75	8	3	°	B38 0600 075 0800 30	6	30		75	8	3	•	
587 0600 100 0800 57		57		100	8	3	°	B38 0600 100 0800 57		57		100	8	3	•	
587 0800 070 1000 25		25		70	10	4	°	B38 0800 070 1000 25		25		70	10	4	•	
587 0800 075 1000 30	8	30		75	10	4	°	B38 0800 075 1000 30	8	30		75	10	4	•	
587 0800 100 1000 57		57		100	10	4	°	B38 0800 100 1000 57		57		100	10	4	°	
587 1000 075 1200 30	10			75	12	4	°	B38 1000 075 1200 30	10			75	12	4	•	
587 1200 075 1400 30		30		75	14	4	°	B38 1200 075 1400 30		30		75	14	4	°	
587 1200 100 1400 55	12			100	14	4	°	B38 1200 100 1400 55	12			100	14	4	°	
587 1600 100 1800 55	16	55		100	18	4	°	B38 1600 100 1800 55	16	55		100	18	4	°	

Material Group | Material-Gruppe | Groupe Matière | Gruppo Materiali | 材质主类

Cutting Parameter

N01	N02	N03	K01	K02	P01	P02	P03	M01	M02	S01	S02	S03	H01	H02	O01	O02	346
-----	-----	-----	-----	-----	-----	-----	-----	-----	-----	-----	-----	-----	-----	-----	-----	-----	-----

TE 45 DIE-SINKING CUTTERS WITH 1.5° INCLINATION, 3 - 4 FLUTES

- VHM TE 45 Gesenkräuser, kegelig mit einem Winkel von 1.5° - 3 bzw. 4 Zähne
- Frese conica per stampi TE 45 con angolo di 1.5°, 3 - 4 taglienti
- Fraises coniques TE 45 pour matrices avec 1.5° d'inclinaison, 3 ou 4 dents suivant Ø
- 整体硬质合金 TE 45 系列 锥形铣刀3/4刃-锥度1.5°

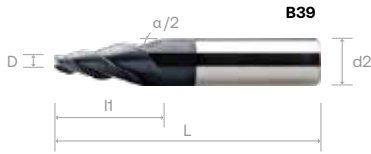
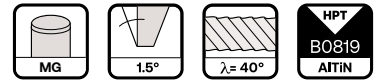

Order Number	Dimension (mm)						UC	Order Number	Dimension (mm)						B0819	
	D	I1	I2	L	d2 (h6)	Z			D	I1	I2	L	d2 (h6)	Z		
591 0050 040 0300 02	0.5	2		40	3	3	°	B39 0050 040 0300 02	0.5	2		40	3	3	°	
591 0060 040 0300 03	0.6			40	3	3	°	B39 0060 040 0300 03	0.6			40	3	3	°	
591 0080 040 0300 03	0.8	3		40	3	3	°	B39 0080 040 0300 03	0.8	3		40	3	3	°	
591 0100 050 0400 04	1	4		50	4	3	°	B39 0100 050 0400 04	1	4		50	4	3	°	
591 0150 050 0400 05	1.5	5		50	4	3	°	B39 0150 050 0400 05	1.5	5		50	4	3	°	
591 0200 050 0400 06	2	6		50	4	3	°	B39 0200 050 0400 06	2	6		50	4	3	•	
591 0250 050 0400 08		8		50	4	3	°	B39 0250 050 0400 08		8		50	4	3	°	
591 0250 060 0400 20	2.5	20		60	4	3	°	B39 0250 060 0400 20	2.5	20		60	4	3	•	
591 0300 050 0600 10		10		50	6	3	°	B39 0300 050 0600 10		10		50	6	3	•	
591 0300 060 0400 19	3	19		60	4	3	°	B39 0300 060 0400 19	3	19		60	4	3	•	
591 0300 075 0500 35		35		75	5	3	°	B39 0300 075 0500 35		35		75	5	3	•	
591 0350 060 0500 20	3.5	20		60	5	3	°	B39 0350 060 0500 20	3.5	20		60	5	3	°	
591 0400 050 0600 15		15		50	6	3	•	B39 0400 050 0600 15		15		50	6	3	•	
591 0400 060 0500 19	4	19		60	5	3	°	B39 0400 060 0500 19	4	19		60	5	3	•	
591 0400 075 0600 35		35		75	6	3	°	B39 0400 075 0600 35		35		75	6	3	•	
591 0500 075 0800 35	5	35		75	8	3	°	B39 0500 075 0800 35	5	35		75	8	3	•	
591 0500 100 0800 57		57		100	8	3	°	B39 0500 100 0800 57		57		100	8	3	•	
591 0600 064 0800 20		20		64	8	3	°	B39 0600 064 0800 20		20		64	8	3	°	
591 0600 075 0800 35	6	35		75	8	3	°	B39 0600 075 0800 35	6	35		75	8	3	•	
591 0600 100 1000 60		60		100	10	3	°	B39 0600 100 1000 60		60		100	10	3	°	
591 0800 070 1000 25		25		70	10	4	°	B39 0800 070 1000 25		25		70	10	4	°	
591 0800 075 1000 35	8	35		75	10	4	°	B39 0800 075 1000 35	8	35		75	10	4	•	
591 0800 100 1200 60		60		100	12	4	°	B39 0800 100 1200 60		60		100	12	4	°	
591 1000 075 1200 38	10	38		75	12	4	°	B39 1000 075 1200 38	10	38		75	12	4	•	
591 1200 075 1400 35		35		75	14	4	°	B39 1200 075 1400 35		35		75	14	4	°	
591 1200 100 1600 60	12	60		100	16	4	°	B39 1200 100 1600 60	12	60		100	16	4	•	
591 1600 100 2000 65	16	65		100	20	4	°	B39 1600 100 2000 65	16	65		100	20	4	•	

ALL LINE
EZ LINE -
ENDMILL
SE 30
NITCO 30
OPTIMUM
SE 45
SE 45X
NITCO 45
SE 60
SE 60X
DM70 -
SE 70
SE GR
TE 45
PLUNGE
-MILL
THREAD
MILL

Material Group | Material-Gruppe | Groupe Matiere | Gruppo Materiali | 材质主类

Cutting Parameter

N01	N02	N03	K01	K02	P01	P02	P03	M01	M02	S01	S02	S03	H01	H02	O01	O02
-----	-----	-----	-----	-----	-----	-----	-----	-----	-----	-----	-----	-----	-----	-----	-----	-----

346

TE 45 DIE-SINKING CUTTERS WITH 2.0° INCLINATION, 3 - 4 FLUTES

- VHM TE 45 Gesenkräuser, kegelig mit einem Winkel von 2.0° - 3 bzw. 4 Zähne
- Frese conica per stampi TE 45 con angolo di 2.0°, 3 - 4 taglianti
- Fraises coniques TE 45 pour matrices avec 2.0° d'inclinaison, 3 ou 4 dents suivant Ø
- 整体硬质合金 TE 45 系列 锥形铣刀3/4刀-锥度2.0°

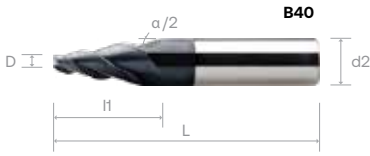

Order Number	Dimension (mm)						UC	Order Number	Dimension (mm)						B0819	
	D	I1	I2	L	d2 (h6)	Z			D	I1	I2	L	d2 (h6)	Z		
595 0050 040 0300 02	0.5	2		40	3	3	o	B40 0050 040 0300 02	0.5	2		40	3	3	o	
595 0060 040 0300 03	0.6	3		40	3	3	o	B40 0060 040 0300 03	0.6	3		40	3	3	o	
595 0080 040 0300 03	0.8			40	3	3	o	B40 0080 040 0300 03	0.8			40	3	3	o	
595 0100 050 0400 04	1	4		50	4	3	o	B40 0100 050 0400 04	1	4		50	4	3	•	
595 0150 050 0400 05	1.5	5		50	4	3	o	B40 0150 050 0400 05	1.5	5		50	4	3	o	
595 0200 050 0400 06	2	6		50	4	3	o	B40 0200 050 0400 06	2	6		50	4	3	•	
595 0250 050 0400 08		8		50	4	3	o	B40 0250 050 0400 08		8		50	4	3	o	
595 0250 060 0400 20	2.5	20		60	4	3	o	B40 0250 060 0400 20	2.5	20		60	4	3	•	
595 0300 050 0600 10		10		50	6	3	•	B40 0300 050 0600 10		10		50	6	3	•	
595 0300 060 0500 25	3	25		60	5	3	o	B40 0300 060 0400 20	3	20		60	4	3	•	
595 0300 075 0600 40		40		75	6	3	•	B40 0300 075 0500 40		40		75	5	3	•	
595 0350 060 0500 20	3.5	20		60	5	3	o	B40 0350 060 0500 20	3.5	20		60	5	3	•	
595 0400 050 0600 15		15		50	6	3	o	B40 0400 050 0600 15		15		50	6	3	o	
595 0400 060 0600 20	4	20		60	6	3	o	B40 0400 065 0500 20	4	20		65	5	3	•	
595 0400 075 0600 28		28		75	6	3	o	B40 0400 075 0500 30		30		75	5	3	•	
595 0500 064 0800 20	5	20		64	8	3	o	B40 0500 060 0600 20		20		60	6	3	•	
595 0500 075 0800 35		35		75	8	3	o	B40 0500 075 0600 30	5	30		75	6	3	o	
595 0600 064 0800 20	6	20		64	8	3	o	B40 0500 100 0800 55		55		100	8	3	•	
595 0600 075 0800 28		28		75	8	3	o	B40 0600 064 0800 20		20		64	8	3	•	
595 0600 100 1000 57		57		100	10	3	o	B40 0600 075 0800 30	6	30		75	8	3	•	
595 0800 070 1000 25	8	25		70	10	4	o	B40 0600 100 0800 57		57		100	8	3	o	
595 0800 075 1000 28		28		75	10	4	o	B40 0800 070 1000 25		25		70	10	4	•	
595 0800 100 1200 57		57		100	12	4	o	B40 0800 075 1000 30	8	30		75	10	4	o	
595 1000 075 1200 28	10	28		75	12	4	o	B40 0800 100 1000 57		57		100	10	4	o	
595 1200 075 1400 28				75	14	4	•	B40 1000 075 1200 30	10	30		75	12	4	o	
595 1200 100 1600 57	12	57		100	16	4	o	B40 1200 075 1400 30				75	14	4	•	
595 1600 100 2000 55	16	55		100	20	4	o	B40 1200 100 1400 55	12	55		100	14	4	o	

Material Group | Material-Gruppe | Groupe Matiere | Gruppo Materiali | 材质主类

Cutting Parameter

N01	N02	N03	K02	P01	P02	P03	M01	M02	S01	S02	S03	H01	H02	O01	O02	346
-----	-----	-----	-----	-----	-----	-----	-----	-----	-----	-----	-----	-----	-----	-----	-----	-----

TE 45 DIE-SINKING CUTTERS WITH 2.5° INCLINATION, 3 - 4 FLUTES

- VHM TE 45 Gesenkräuser, kegelig mit einem Winkel von 2.5° - 3 bzw. 4 Zähne
- Frese conica per stampi TE 45 con angolo di 2.5°, 3 - 4 taglienti
- Fraises coniques TE 45 pour matrices avec 2.5° d'inclinaison, 3 ou 4 dents suivant Ø
- 整体硬质合金 TE 45 系列 锥形铣刀3/4刃-锥度2.5°

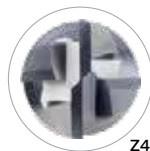
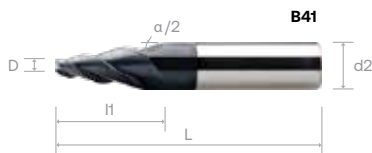
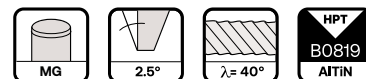

Order Number	Dimension (mm)						UC	Order Number	Dimension (mm)						B0819
	D	I1	I2	L	d2 (h6)	Z			D	I1	I2	L	d2 (h6)	Z	
599 0050 040 0300 02	0.5	2		40	3	3	°	B41 0050 040 0300 02	0.5	2		40	3	3	°
599 0060 040 0300 03	0.6	3		40	3	3	°	B41 0060 040 0300 03	0.6	3		40	3	3	°
599 0080 040 0300 03	0.8			40	3	3	°	B41 0080 040 0300 03	0.8			40	3	3	°
599 0100 050 0400 04	1		4		50	4	3	°	B41 0100 050 0400 04		1	4		50	4
599 0150 050 0400 05	1.5	5		50	4	3	°	B41 0150 050 0400 05	1.5	5		50	4	3	°
599 0200 050 0400 06	2	6		50	4	3	°	B41 0200 050 0400 06	2	6		50	4	3	°
599 0250 050 0400 08	2.5	8		50	4	3	°	B41 0250 050 0400 08	2.5	8		50	4	3	°
599 0300 050 0600 10	3	10		50	6	3	°	B41 0300 050 0600 10	3	10		50	6	3	°
599 0400 050 0600 15	4	15		50	6	3	°	B41 0400 050 0600 15	4	15		50	6	3	°
599 0500 064 0800 20	5	20		64	8	3	°	B41 0500 064 0800 20	5	20		64	8	3	°
599 0600 064 0800 20	6			64	8	3	°	B41 0600 064 0800 20	6			64	8	3	°

- ALL LINE
- EZ LINE - ENDMILL
- SE 30
- NITICO 30
- OPTIMUM
- SE 45
- SE 45X
- NITICO 45
- SE 60
- SE 60X
- DN70 - SE 70
- SE GR
- TE 45
- PLUNGE -MILL
- THREAD MILL

Material Group | Material-Gruppe | Groupe Matiere | Gruppo Materiali | 材质主类

Cutting Parameter

N01	N02	N03	K01	K02	P01	P02	P03	M01	M02	S01	S02	S03	H01	H02	O01	O02
-----	-----	-----	-----	-----	-----	-----	-----	-----	-----	-----	-----	-----	-----	-----	-----	-----

346

TE 45 DIE-SINKING CUTTERS WITH 3.0° INCLINATION, 3 - 4 FLUTES

- VHM TE 45 Gesenkfräser, kegelig mit einem Winkel von 3.0° - 3 bzw. 4 Zähne
- Frese conica per stampi TE 45 con angolo di 3.0°, 3 - 4 taglianti
- Fraises coniques TE 45 pour matrices avec 3.0° d'inclinaison, 3 ou 4 dents suivant Ø
- 整体硬质合金 TE 45 系列 锥形铣刀3/4刀-锥度3.0°

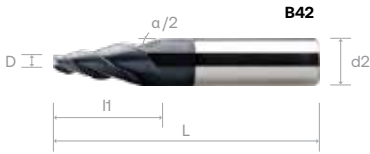
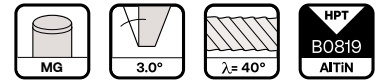

Order Number	Dimension (mm)						UC	Order Number	Dimension (mm)						B0819		
	D	I1	I2	L	d2 (h6)	Z			D	I1	I2	L	d2 (h6)	Z			
603 0050 040 0300 02	0.5	2		40	3	3	°	B42 0050 040 0300 02	0.5	2		40	3	3	°		
603 0060 040 0300 03	0.6	3		40	3	3	°	B42 0060 040 0300 03	0.6	3		40	3	3	°		
603 0080 040 0300 03	0.8			40	3	3	°	B42 0080 040 0300 03	0.8				40	3	3	°	
603 0100 050 0400 04	1	4		50	4	3	°	B42 0100 050 0400 04	1	4		50	4	3	°		
603 0150 050 0400 05	1.5	5		50	4	3	°	B42 0150 050 0400 05	1.5	5		50	4	3	°		
603 0200 050 0400 06	2	6		50	4	3	°	B42 0200 050 0400 06	2	6		50	4	3	°		
603 0250 050 0400 08	2.5	8		50	4	3	°	B42 0250 050 0400 08	2.5	8		50	4	3	°		
603 0250 060 0500 20		20		60	5	3	°	B42 0250 060 0500 20		20			60	5	3	°	
603 0300 050 0600 10	3	10		50	6	3	•	B42 0300 050 0600 10	3	10		50	6	3	•		
603 0300 060 0600 25		25		60	6	3	°	B42 0300 060 0600 25		25			60	6	3	•	
603 0300 075 0800 40		40		75	8	3	•	B42 0300 075 0800 40		40			75	8	3	°	
603 0350 060 0600 23	3.5	23		60	6	3	°	B42 0350 060 0600 23	3.5	23		60	6	3	•		
603 0400 050 0600 15	4	15		50	6	3	°	B42 0400 050 0600 15	4	15		50	6	3	•		
603 0400 075 0800 38		38		75	8	3	°	B42 0400 075 0800 38		38			75	8	3	°	
603 0500 064 0800 20	5	20		64	8	3	°	B42 0500 064 0800 20	5	20		64	8	3	°		
603 0500 075 0800 28		28		75	8	3	°	B42 0500 075 0800 28		28			75	8	3	°	
603 0600 075 1000 38	6	38		75	10	3	•	B42 0600 075 1000 38	6	38		75	10	3	•		
603 0600 100 1200 57		57		100	12	3	•	B42 0600 100 1200 57		57			100	12	3	•	
603 0800 075 1200 25	8	25		75	12	4	°	B42 0800 075 1200 25	8	25		75	12	4	°		
603 0800 075 1200 38		38		75	12	4	°	B42 0800 075 1200 38		38			75	12	4	°	
603 0800 100 1400 57		57		100	14	4	°	B42 0800 100 1400 57		57			100	14	4	°	
603 1000 075 1400 38	10	38		75	14	4	°	B42 1000 075 1400 38	10	38		75	14	4	°		
603 1200 075 1600 38				75	16	4	°	B42 1200 075 1600 38					75	16	4	°	
603 1200 100 1800 55	12	55		100	18	4	°	B42 1200 100 1800 55	12	55		100	18	4	°		

Material Group | Material-Gruppe | Groupe Matière | Gruppo Materiali | 材质主类

Cutting Parameter

N01	N02	N03	K01	K02	P01	P02	P03	M01	M02	S01	S02	S03	H01	H02	O01	O02	346
-----	-----	-----	-----	-----	-----	-----	-----	-----	-----	-----	-----	-----	-----	-----	-----	-----	-----

TE 45 DIE-SINKING CUTTERS WITH 4.0° INCLINATION, 3 - 4 FLUTES

- VHM TE 45 Gesenkräuser, kegelig mit einem Winkel von 4.0° - 3 bzw. 4 Zähne
- Frese conica per stampi TE 45 con angolo di 4.0°, 3 - 4 taglienti
- Fraises coniques TE 45 pour matrices avec 4.0° d'inclinaison, 3 ou 4 dents suivant Ø
- 整体硬质合金 TE 45 系列 锥形铣刀3/4刃-锥度4.0°

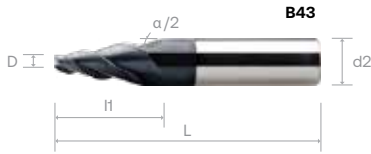
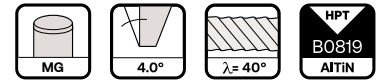

Order Number	Dimension (mm)						UC	Order Number	Dimension (mm)						B0819	
	D	I1	I2	L	d2 (h6)	Z			D	I1	I2	L	d2 (h6)	Z		
607 0250 060 0600 25	2.5	25		60	6	3	°	B43 0250 060 0600 25	2.5	25		60	6	3	°	
607 0300 075 0800 35	3	35		75	8	3	°	B43 0300 075 0800 35	3	35		75	8	3	°	
607 0350 075 0800 32	3.5	32		75	8	3	•	B43 0350 075 0800 32	3.5	32		75	8	3	•	
607 0400 075 0800 28	4	28		75	8	3	°	B43 0400 075 0800 28	4	28		75	8	3	°	
607 0500 075 1000 35	5	35		75	10	3	°	B43 0500 075 1000 35	5	35		75	10	3	°	
607 0600 100 1200 42	6	42		100	12	3	°	B43 0600 100 1200 42	6	42		100	12	3	•	
607 0800 075 1200 28	8	28		75	12	4	°	B43 0800 075 1200 28	8	28		75	12	4	°	
607 0800 100 1600 57		57		100	16	4	°	B43 0800 100 1600 57		57		100	16	4	°	
607 1000 100 1600 42	10	42		100	16	4	°	B43 1000 100 1600 42	10	42		100	16	4	°	

ALL LINE
 EZ LINE -
 ENDMILL
 SE 30
 NITICO 30
 OPTIMUM
 SE 45
 SE 45X
 NITICO 45
 SE 60
 SE 60X
 DN70 -
 SE 70
 SE GR
TE 45
 PLUNGE
 -MILL
 THREAD
 MILL

Material Group | Material-Gruppe | Groupe Matière | Gruppo Materiali | 材质主类

Cutting Parameter

N01	N02	N03	K01	K02	P01	P02	P03	M01	M02	S01	S02	S03	H01	H02	O01	O02
-----	-----	-----	-----	-----	-----	-----	-----	-----	-----	-----	-----	-----	-----	-----	-----	-----

346

TE 45 DIE-SINKING CUTTERS WITH 5.0° INCLINATION, 3 - 4 FLUTES

- VHM TE 45 Gesenkfräser, kegelig mit einem Winkel von 5.0° - 3 bzw. 4 Zähne
- Frese conica per stampi TE 45 con angolo di 5.0°, 3 - 4 taglianti
- Fraises coniques TE 45 pour matrices avec 5.0° d'inclinaison, 3 ou 4 dents suivant Ø
- 整体硬质合金 TE 45 系列 锥形铣刀3/4刀-锥度5.0°

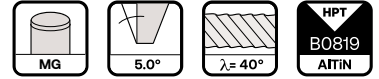

Order Number	Dimension (mm)						UC	Order Number	Dimension (mm)						B0819
	D	I1	I2	L	d2 (h6)	Z			D	I1	I2	L	d2 (h6)	Z	
611 0050 040 0300 02	0.5	2		40	3	3	◦	B44 0050 040 0300 02	0.5	2		40	3	3	•
611 0060 040 0300 03	0.6	3		40	3	3	◦	B44 0060 040 0300 03	0.6	3		40	3	3	◦
611 0080 040 0300 03	0.8			40	3	3	◦	B44 0080 040 0300 03	0.8			40	3	3	◦
611 0100 050 0400 04	1		4		50	4	3	◦	B44 0100 050 0400 04		1	4		50	4
611 0150 050 0400 05	1.5	5		50	4	3	◦	B44 0150 050 0400 05	1.5	5		50	4	3	•
611 0200 050 0400 06	2	6		50	4	3	•	B44 0200 050 0400 06	2	6		50	4	3	◦
611 0250 050 0400 08	2.5	8		50	4	3	◦	B44 0250 050 0400 08	2.5	8		50	4	3	◦
611 0250 060 0600 20		20		60	6	3	◦	B44 0250 060 0500 20		20		60	6	3	◦
611 0300 050 0600 10	3	10		50	6	3	◦	B44 0300 050 0600 10	3	10		50	6	3	◦
611 0300 075 0800 28		28		75	8	3	◦	B44 0300 060 0600 25		28		75	8	3	•
611 0300 075 1000 40		40		75	10	3	◦	B44 0300 075 0800 40		40		75	10	3	•
611 0350 075 0800 25	3.5	25		75	8	3	◦	B44 0350 060 0600 23	3.5	25		75	8	3	◦
611 0400 064 0800 15	4	15		64	8	3	◦	B44 0400 050 0600 15	4	15		64	8	3	◦
611 0400 075 0800 22		22		75	8	3	◦	B44 0400 075 0800 38		22		75	8	3	•
611 0500 070 1000 20	5	20		70	10	3	•	B44 0500 064 0800 20	5	20		70	10	3	•
611 0500 075 1000 28		28		75	10	3	◦	B44 0500 075 0800 28		28		75	10	3	•
611 0600 070 1000 20	6	20		70	10	3	◦	B44 0600 064 0800 20	6	20		70	10	3	•
611 0600 075 1200 34		34		75	12	3	•	B44 0600 075 1000 38		34		75	12	3	◦
611 0600 100 1600 57		57		100	16	3	◦	B44 0600 100 1200 57		57		100	16	3	◦
611 0800 090 1600 25	8	25		90	16	4	◦	B44 0800 075 1200 25	8	25		90	16	4	◦
611 0800 075 1400 34		34		75	14	4	◦	B44 0800 075 1200 38		34		75	14	4	◦
611 0800 100 1800 57		57		100	18	4	◦	B44 0800 100 1400 57		57		100	18	4	◦
611 1000 075 1600 34	10	34		75	16	4	◦	B44 1000 075 1400 38	10	34		75	16	4	◦
611 1000 100 1800 45		45		100	18	4	◦	B44 1200 075 1600 38		45		100	18	4	•
611 1200 100 2000 45	12		100	20	4	•	B44 1200 100 1800 55	12		100	20	4	◦		

Material Group | Material-Gruppe | Groupe Matière | Gruppo Materiali | 材质主类

Cutting Parameter

N01	N02	N03	K01	K02	P01	P02	P03	M01	M02	S01	S02	S03	H01	H02	O01	O02	346
-----	-----	-----	-----	-----	-----	-----	-----	-----	-----	-----	-----	-----	-----	-----	-----	-----	-----

ALU LINE
 EZ LINE - ENDMILL
 SE 30
 NITCo 30
 OPTIMUM
 SE 45
 SE 45X
 NITCo 45
 SE 60
 SE 60X
 DM70 - SE70
 SE GR
 TE 45
 PLUNGE -MILL
 THREAD MILL

TE 45 DIE-SINKING CUTTERS WITH 7.0° INCLINATION, 3 - 4 FLUTES

- VHM TE 45 Gesenckfräser, kegelig mit einem Winkel von 7.0° - 3 bzw. 4 Zähne
- Frese conica per stampi TE 45 con angolo di 7.0°, 3 - 4 taglienti
- Fraises coniques TE 45 pour matrices avec 7.0° d'inclinaison, 3 ou 4 dents suivant Ø
- 整体硬质合金 TE 45 系列 锥形铣刀3/4刃-锥度7.0°

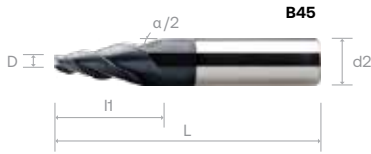
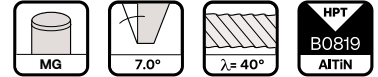

Order Number	Dimension (mm)						UC	Order Number	Dimension (mm)						B0819	
	D	L1	L2	L	d2 (h6)	Z			D	L1	L2	L	d2 (h6)	Z		
615 0050 040 0300 02	0.5	2		40	3	3	°	B45 0050 040 0300 02	0.5	2		40	3	3	°	
615 0060 040 0300 03	0.6	3		40	3	3	°	B45 0060 040 0300 03	0.6	3		40	3	3	°	
615 0080 040 0300 03	0.8			40	3	3	°	B45 0080 040 0300 03	0.8			40	3	3	°	
615 0100 050 0400 04	1	4		50	4	3	•	B45 0100 050 0400 04	1	4		50	4	3	•	
615 0150 050 0400 05	1.5	5		50	4	3	°	B45 0150 050 0400 05	1.5	5		50	4	3	°	
615 0200 050 0400 06	2	6		50	4	3	°	B45 0200 050 0400 06	2	6		50	4	3	°	
615 0250 050 0600 08	2.5	8		50	6	3	°	B45 0250 050 0600 08	2.5	8		50	6	3	°	
615 0250 075 0800 22		22		75	8	3	°	B45 0250 075 0800 22		22		75	8	3	°	
615 0300 050 0600 10	3	10		50	6	3	°	B45 0300 050 0600 10	3	10		50	6	3	•	
615 0300 075 1000 28		28		75	10	3	°	B45 0300 075 1000 28		28		75	10	3	°	
615 0300 100 1400 44		44		100	14	3	°	B45 0300 100 1400 44		44		100	14	3	°	
615 0350 075 1000 26	3.5	26		75	10	3	°	B45 0350 075 1000 26	3.5	26		75	10	3	°	
615 0400 064 0800 15	4	15		64	8	3	°	B45 0400 064 0800 15	4	15		64	8	3	°	
615 0400 075 1000 24		24		75	10	3	°	B45 0400 075 1000 24		24		75	10	3	°	
615 0400 075 1200 32		32		75	12	3	°	B45 0400 075 1200 32		32		75	12	3	°	
615 0500 070 1000 20	5	20		70	10	3	°	B45 0500 070 1000 20	5	20		70	10	3	°	
615 0500 075 1200 28		28		75	12	3	°	B45 0500 075 1200 28		28		75	12	3	°	
615 0600 075 1400 32	6	32		75	14	3	°	B45 0600 075 1400 32	6	32		75	14	3	•	
615 0600 100 1800 48		48		100	18	3	°	B45 0600 100 1800 48		48		100	18	3	•	
615 0800 075 1600 32	8	32		75	16	4	°	B45 0800 075 1600 32	8	32		75	16	4	°	
615 0800 100 2000 48		48		100	20	4	°	B45 0800 100 2000 48		48		100	20	4	°	
615 1000 075 1800 32	10	32		75	18	4	°	B45 1000 075 1800 32	10	32		75	18	4	°	
615 1200 100 2000 32	12			100	20	4	°	B45 1200 100 2000 32	12			100	20	4	°	

ALL LINE
 EZ LINE - ENDMILL
 SE 30
 NITCO 30
 OPTIMUM
 SE 45
 SE 45X
 NITCO 45
 SE 60
 SE 60X
 DN70 - SE 70
 SE GR
TE 45
 PLUNGE -MILL
 THREAD MILL

Material Group | Material-Gruppe | Groupe Matière | Gruppo Materiali | 材质主类

Cutting Parameter

N01	N02	N03	K01	K02	P01	P02	P03	M01	M02	S01	S02	S03	H01	H02	O01	O02	346
-----	-----	-----	-----	-----	-----	-----	-----	-----	-----	-----	-----	-----	-----	-----	-----	-----	-----

TE 45 DIE-SINKING CUTTERS WITH 10.0° INCLINATION, 3 FLUTES

- VHM TE 45 Gesenkfräser, kegelig mit einem Winkel von 10.0° - 3 Zähne
- Frese conica per stampi TE 45 con angolo di 10.0°, 3 taglianti
- Fraises coniques TE 45 pour matrices avec 10.0° d'inclinaison, 3 dents suivant Ø
- 整体硬质合金 TE 45 系列 锥形铣刀3刃-锥度10.0°

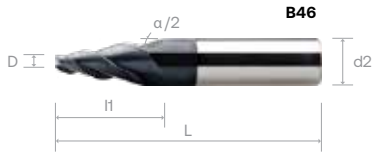

Order Number	Dimension (mm)					UC	Order Number	Dimension (mm)					B0819
	D	I1	I2	L	d2 (h6)			D	I1	I2	L	d2 (h6)	
618 0050 040 0300 02	0.5	2		40	3	•	B46 0050 040 0300 02	0.5	2		40	3	•
618 0060 040 0300 03	0.6	3		40	3	•	B46 0060 040 0300 03	0.6	3		40	3	•
618 0080 040 0300 03	0.8			40	3	•	B46 0080 040 0300 03	0.8			40	3	◦
618 0100 050 0400 04	1	4		50	4	•	B46 0100 050 0400 04	1	4		50	4	◦
618 0150 050 0400 05	1.5	5		50	4	◦	B46 0150 050 0400 05	1.5	5		50	4	•
618 0200 050 0600 06	2	6		50	6	◦	B46 0200 050 0600 06	2	6		50	6	•
618 0250 050 0600 08	2.5	8		50	6	◦	B46 0250 050 0600 08	2.5	8		50	6	•
618 0250 075 1000 21		21		75	10	◦	B46 0250 075 1000 21		21		75	10	◦
618 0300 064 0800 10	3	10		64	8	◦	B46 0300 064 0800 10	3	10		64	8	◦
618 0300 075 1200 25		25		75	12	◦	B46 0300 075 1200 25		25		75	12	◦
618 0300 100 1800 42		42		100	18	◦	B46 0300 100 1800 42		42		100	18	◦
618 0350 075 1200 24	3.5	24		75	12	◦	B46 0350 075 1200 24	3.5	24		75	12	◦
618 0400 070 1000 15	4	15		70	10	◦	B46 0400 070 1000 15	4	15		70	10	◦
618 0400 075 1200 22		22		75	12	◦	B46 0400 075 1200 22		22		75	12	•
618 0400 100 1600 34		34		100	16	◦	B46 0400 100 1600 34		34		100	16	•
618 0500 075 1200 20	5	20		75	12	◦	B46 0500 075 1200 20	5	20		75	12	•
618 0500 075 1600 31		31		75	16	◦	B46 0500 075 1600 31		31		75	16	◦
618 0600 100 1800 34	6	34		100	18	◦	B46 0600 100 1800 34	6	34		100	18	◦

Material Group | Material-Gruppe | Groupe Matière | Gruppo Materiali | 材质主类

Cutting Parameter

N01	N02	N03	K01	K02	P01	P02	P03	M01	M02	S01	S02	S03	H01	H02	O01	O02	346
-----	-----	-----	-----	-----	-----	-----	-----	-----	-----	-----	-----	-----	-----	-----	-----	-----	-----

Note: These recommended cutting data indicators are just for reference. They should be adjusted according to the different cutting condition



TE 45 Die Sinking Cutters, 3 Flutes - 583, 587, 591, 595, 599, 603, 607, 611, 615, 618, B37, B38, B39, B40, B41, B42, B43, B44, B45, B46

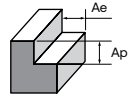

Side Milling	K		P		H	
Working Material	Ductile Cast Iron		Prehardened steel		Hardened steel	
Properties	-		35 ≤ HRC < 45		45 ≤ HRC < 52	
Cutting depth, ap	Ap = L1		Ap = L1		Ap = L1	
Cutting Width, ae	0.10xD		0.10xD		0.15 × D	
D	Vc	Fz	Vc	Fz	Vc	Fz
1	30	0.005	35	0.005	25	0.004
2		0.009		0.010		0.008
3		0.014		0.015		0.012
4		0.018		0.020		0.016
5		0.022		0.025		0.020
6		0.027		0.030		0.024

TE 45 Die Sinking Cutters, 4 Flutes - 583, 587, 591, 595, 599, 603, 607, 611, 615, 618, B37, B38, B39, B40, B41, B42, B43, B44, B45, B46

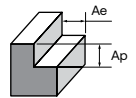

Side Milling	K		P		H	
Working Material	Ductile Cast Iron		Prehardened steel		Hardened steel	
Properties	-		35 ≤ HRC < 45		45 ≤ HRC < 52	
Cutting depth, ap	Ap = L1		Ap = L1		Ap = L1	
Cutting Width, ae	0.10xD		0.10xD		0.10xD	
D	Vc	Fz	Vc	Fz	Vc	Fz
8	80	0.014	95	0.015	70	0.012
10		0.018		0.019		0.015
12		0.021		0.022		0.018
16		0.028		0.029		0.023

ALL LINE
 EZ LINE -
 ENDMILL
 SE 30
 NITCO 30
 OPTIMUM
 SE 45
 SE 45X
 NITCO 45
 SE 60
 SE 60X
 DN70 -
 SE 70
 SE GR
TE 45
 PLUNGE
 -MILL
 THREAD
 MILL

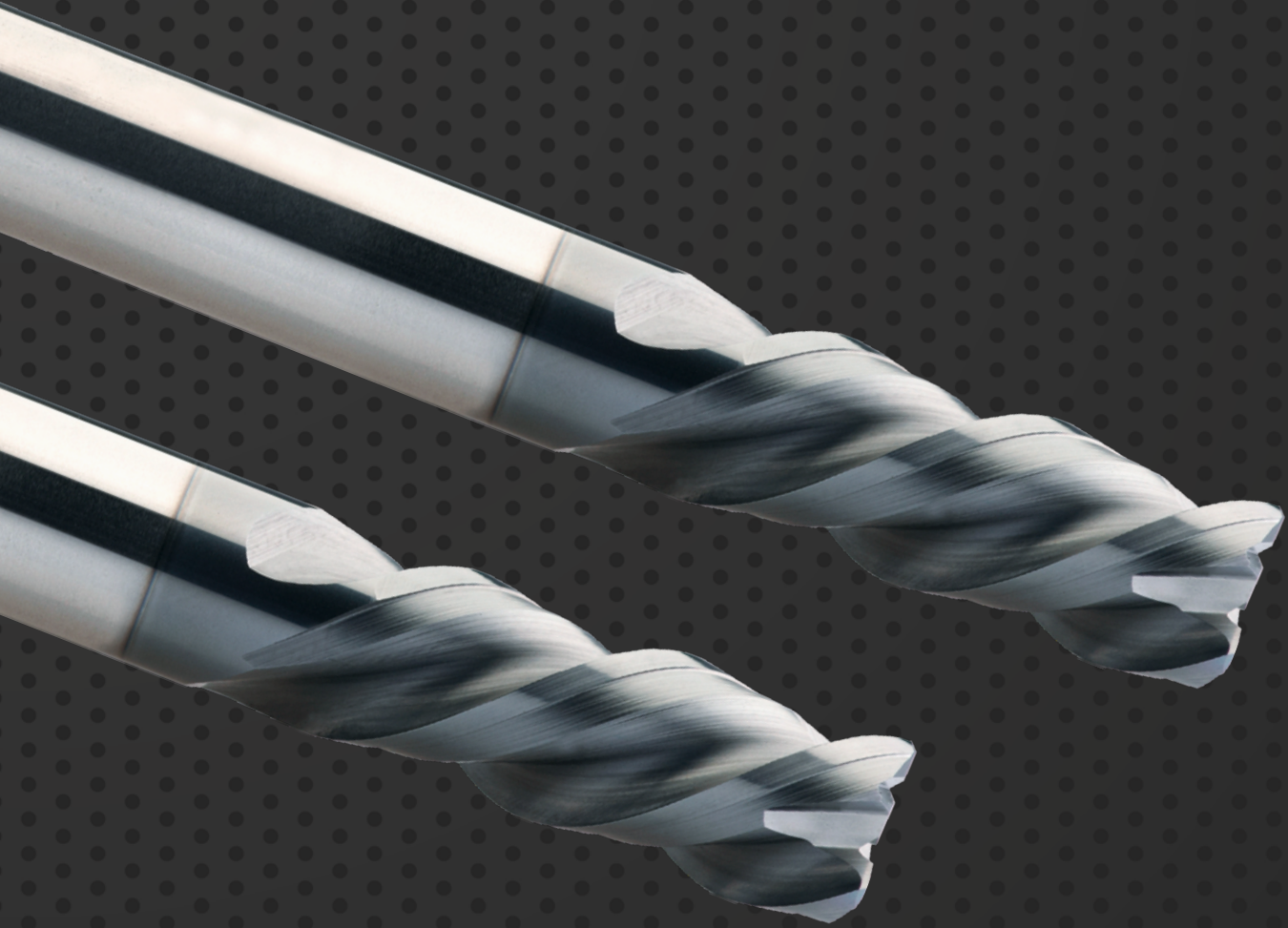

ENDMILLS

PLUNGE-MILL

For material P, M, K, N application (≤ 45 HRC)

Index - PLUNGE-MILL, For ≤ 45 HRC

 Suitable for Material Groups
  Adapté pour les matériaux
  适用于材料
 Geeignet für die Materialgruppen
  Adatto per il materiale

P
K

EDP Number	Type	No. Z	Helix Angle	Coating	Performance	Page Number
G10 	PLUNGE-MILL	4	45°	G610	G	349
G12 	PLUNGE-MILL, Recess	4	45°	G610	G	349

G - General P - Performance

PLUNGE-MILL, FOR PLUNGING + SLOTTING + MILLING / RECESS, 3 FLUTES

- VHM Schaftfräser, 3 Zähne, zum Bohren, Nuten- und Umfangsfräsen
- Frese per lavorazioni a tuffo, dal pieno e contornature, 3 taglienti
- Fraises Plongée, 3 dents, pour usinages en plongée, rainurage
- 整体硬质合金 Plunge-mill 系列.立铣刀3刃,适用于开槽.侧铣.插铣

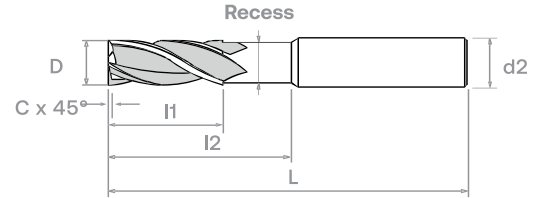
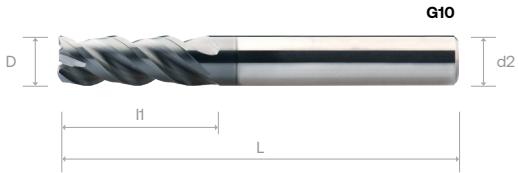
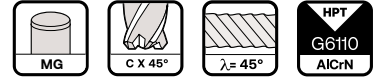

Order Number	Dimension (mm)						G6110	Order Number	Dimension (mm)						G6110
	D	I1	I2	L	d2 (h6)	C			D	I1	I2	L	d2 (h6)	C	
G10 0100 050 04	1	1.5		50	4	0.1	•	G12 0100 050 04	1	1.5	5	50	4	0.1	◦
G10 0150 050 04	1.5	2.3		50	4	0.1	•	G12 0150 050 04	1.5	2.3	7.5	50	4	0.1	•
G10 0200 050 04	2	3		50	4	0.1	•	G12 0200 050 04	2	3	10	50	4	0.1	◦
G10 0250 050 04	2.5	3.8		50	4	0.1	•	G12 0250 050 04	2.5	3.8	12.5	50	4	0.1	◦
G10 0300 050 06 *	3	6		50	6	0.2	•	G12 0300 050 06	3	6	15	50	6	0.2	•
G10 0400 050 06 *	4	8		50	6	0.2	•	G12 0400 050 06	4	8	20	50	6	0.2	•
G10 0500 050 06 *	5	10		50	6	0.25	•	G12 0500 050 06	5	10	20	50	6	0.25	•
G10 0600 050	6	13		50	6	0.25	•	G12 0600 050	6	13	20	50	6	0.25	◦
G10 0800	8	20		64	8	0.3	•	G12 0800	8	20	30	64	8	0.3	◦
G10 1000	10	22		75	10	0.3	•	G12 1000	10	22	32	75	10	0.3	•
G10 1200	12	25		75	12	0.3	•	G12 1200	12	25	37	75	12	0.3	•
G10 1600	16	32		90	16	0.3	•	G12 1600	16	32	46	90	16	0.3	◦

* - DIN 6535

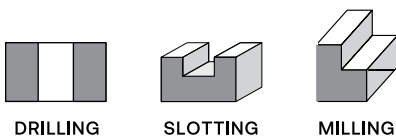

CNC Repeatability
Ø1 - Ø3 within 10µm
Ø4 - Ø8 within 15µm
≥ Ø10 within 20µm

Material Group | Material-Gruppe | Groupe Matière | Gruppo Materiali | 材质主类

Cutting Parameter

N01	N02	N03	K01	K02	P01	P02	P03	M01	M02	S01	S02	S03	H01	H02	O01	O02	350
-----	-----	-----	-----	-----	-----	-----	-----	-----	-----	-----	-----	-----	-----	-----	-----	-----	-----

Recommended Cutting Data



Note: These recommended cutting data indicators are just for reference. They should be adjusted according to the different cutting condition



Plunge-Mill Endmills, 3 Flutes - G10, G12

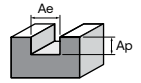

Slotting	K				P			
Working Material	Grey Cast Iron		Carbon steel		Alloy steel		Prehardened steel	
Properties	-		-		520 < Rm < 1200		35 ≤ HRC < 45	
Cutting depth, ap	1.00 × D		1.00 × D		1.00 × D		0.80 × D	
Cutting Width, ae	1.00 × D		1.00 × D		0.30 × D		1.00 × D	
D	Vc	Fz	Vc	Fz	Vc	Fz	Vc	Fz
1	170	0.003	200	0.003	160	0.003	150	0.003
2		0.007		0.007				
3		0.010		0.010				
4		0.013		0.013				
5		0.018		0.018				
6		0.021		0.021				
8		0.029		0.029				
10		0.037		0.036				
12		0.045		0.045				
16		0.060		0.059				

Plunge-Mill Endmills, 3 Flutes - G10, G12

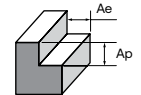

Side Milling	K				P			
Working Material	Grey Cast Iron		Carbon steel		Alloy steel		Prehardened steel	
Properties	-		-		520 < Rm < 1200		35 ≤ HRC < 45	
Cutting depth, ap	1.00 × D		1.00 × D		1.00 × D		1.00 × D	
Cutting Width, ae	0.25 × D		0.25 × D		0.25 × D		0.18 × D	
D	Vc	Fz	Vc	Fz	Vc	Fz	Vc	Fz
1	250	0.008	280	0.006	230	0.007	190	0.006
2		0.011		0.010				
3		0.018		0.019				
4		0.024		0.025				
5		0.032		0.033				
6		0.040		0.040				
8		0.054		0.054				
10		0.069		0.068				
12		0.082		0.082				
16		0.094		0.103				

Plunge-Mill Endmills, 3 Flutes - G10, G12

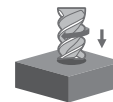

Plunging	K		P			
Working Material	Grey Cast Iron		Carbon steel		Alloy steel	
Properties	-		-		520 < Rm < 1200	
Cutting depth, ap	1.00 × D		1.00 × D		1.00 × D	
Cutting Width, ae	-		-		-	
D	Vc	Fz	Vc	Fz	Vc	Fz
1	150	0.008	150	0.010	130	0.008
2		0.016		0.018		
3		0.025		0.028		
4		0.035		0.038		
5		0.044		0.048		
6		0.054		0.059		
8		0.074		0.080		
10		0.094		0.101		
12		0.118		0.126		
16		0.151		0.144		

AU LINE
 EZ LINE - ENDMILL
 SE 30
 NITICO 30
 OPTIMUM
 SE 45
 SE 45X
 NITICO 45
 SE 60
 SE 60X
 DN70 - SE70
 SE GR
 TE 45
 PLUNGE -MILL
 THREAD MILL



ENDMILLS





THREAD MILL

For material P, M, K, N, S application (≤ 35 HRC)

Index - Thread Mill, For ≤ 35 HRC

Suitable for Material Groups
 Adapté pour les matériaux
 适用于材料
 Geeignet für die Materialgruppen
 Adatto per il materiale



EDP Number	Type	No. Z	Helix Angle	Coating	Performance	Page Number
H19 	Thread Mill M, Without Internal Oil Hole	3/4/5	30°	G610	G	353
H21 	Thread Mill MF, Without Internal Oil Hole	3/4/5	30°	G610	G	353
H15 	Thread Mill M, With Internal Oil Hole	3/4/5	30°	G610	G	354
H17 	Thread Mill MF, With Internal Oil Hole	3/4/5	30°	G610	G	354

G - General P - Performance

THREAD MILL M/MF ENDMILLS WITHOUT INTERNAL OIL HOLE, 3/4/5 FLUTES

- VHM Fräser M /MF Thread mill 3/4/5 Zähne
- Frese M /MF Thread mill in metallo duro integrale 3/4/5 taglienti
- Fraises M /MF Thread mill - 3/4/5 dents
- 整体硬质合金 M/MF 系列 密齿立铣刀3/4/5刃-标准长度

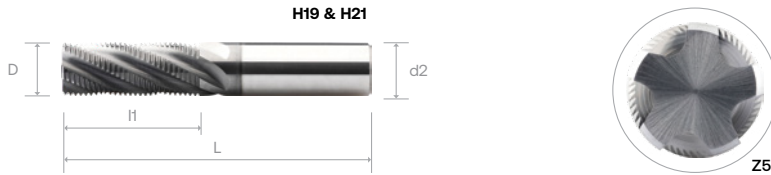
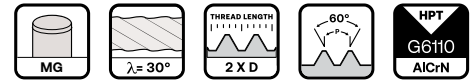

Order Number	Dimension (mm)								G6110
	M	I1	I2	P	d1	L	d2 (h6)	Z	
H19 0600	≥M6	13.00		1.00	4.5	57	6	3	°
H19 0800	≥M8	17.50		1.25	6	60	6	3	°
H19 1000	≥M10	21.00		1.50	7.5	75	8	4	°
H19 1200	≥M12	26.25		1.75	9.5	75	10	4	°
H19 1400	≥M14	30.00		2.00	10	83	10	4	°
H19 1600	≥M16	34.00		2.00	12	83	12	4	°

Order Number	Dimension (mm)								G6110
	M	I1	I2	P	d1	L	d2 (h6)	Z	
H21 0800	≥M8	17.00		1.00	6.0	57	6	3	°
H21 0800 057 06		17.25		0.75	6.0	57	6	3	°
H21 1000	≥M10	21.00		1.00	8.0	64	8	4	°
H21 1200	≥M12	25.50		1.50	9.5	72	10	4	°
H21 1200 072		26.25		1.25	9.5	72	10	4	°
H21 1200 072 10		25.00		1.00	9.5	72	10	4	°
H21 1400	≥M14	30.00		1.50	10.0	83	10	4	°
H21 1400 083 10		29.00		1.00	10.0	83	10	4	°
H21 1600	≥M16	34.50		1.50	12.0	83	12	4	°
H21 1600 083 12		33.00		1.00	12.0	83	12	4	°
H21 1800	≥M18	37.50		1.50	14.0	90	14	5	°
H21 1800 090 14		37.00		1.00	14.0	90	14	5	°
H21 2000	≥M20	42.00		1.50	16.0	92	16	5	°
H21 2000 092 16		41.00		1.00	16.0	92	16	5	°

Material Group | Material-Gruppe | Groupe Matière | Gruppo Materiali | 材质主类

Cutting Parameter

N01	N02	N03	K01	K02	P01	P02	P03	M01	M02	S01	S02	S03	H01	H02	O01	O02	355
-----	-----	-----	-----	-----	-----	-----	-----	-----	-----	-----	-----	-----	-----	-----	-----	-----	-----

ALU LINE
 EZ LINE - ENDMILL
 SE 30
 NITCo 30
 OPTIMUM
 SE 45
 SE 45X
 NITCo 45
 SE 60
 SE 60X
 DM70 - SE70
 SE GR
 TE 45
 PLUNGE -MILL
 THREAD MILL

H15 / H17



THREAD MILL M/MF ENDMILLS WITH INTERNAL OIL HOLE, 3/4/5 FLUTES

- VHM Fräser M /MF Thread mill 3/4/5 Zähne
- Frese M /MF Thread mill in metallo duro integrale 3/4/5 taglienti
- Fraises M /MF Thread mill - 3/4/5 dents
- 整体硬质合金 M/MF 系列 密齿立铣刀3/4/5刃-标准长度

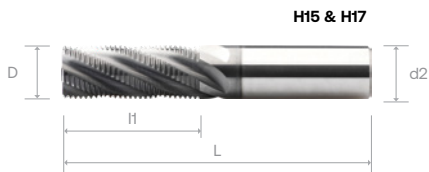
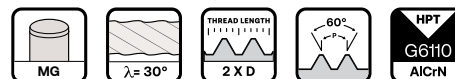

M

Order Number	Dimension (mm)								G6110
	M	I1	I2	P	d1	L	d2 (h6)	Z	
H15 0600	≥M6	13.00		1.00	4.5	57	6	3	°
H15 0800	≥M8	17.50		1.25	6	60	6	3	°
H15 1000	≥M10	21.00		1.50	7.5	75	8	4	°
H15 1200	≥M12	26.25		1.75	9.5	75	10	4	°
H15 1400	≥M14	30.00		2.00	10	83	10	4	°
H15 1600	≥M16	34.00		2.00	12	83	12	4	°

MF

Order Number	Dimension (mm)								G6110
	M	I1	I2	P	d1	L	d2 (h6)	Z	
H17 0800	≥M8	17.00		1.00	6.0	57	6	3	°
H17 0800 057 06		17.25		0.75	6.0	57	6	3	°
H17 1000	≥M10	21.00		1.00	8.0	64	8	4	°
H17 1200	≥M12	25.50		1.50	9.5	72	10	4	°
H17 1200 072		26.25		1.25	9.5	72	10	4	°
H17 1200 072 10		25.00		1.00	9.5	72	10	4	°
H17 1400	≥M14	30.00		1.50	10.0	83	10	4	°
H17 1400 083 10		29.00		1.00	10.0	83	10	4	°
H17 1600	≥M16	34.50		1.50	12.0	83	12	4	°
H17 1600 083 12		33.00		1.00	12.0	83	12	4	°
H17 1800	≥M18	37.50		1.50	14.0	90	14	5	°
H17 1800 090 14		37.00		1.00	14.0	90	14	5	°
H17 2000	≥M20	42.00		1.50	16.0	92	16	5	°
H17 2000 092 16		41.00		1.00	16.0	92	16	5	°

Material Group | Material-Gruppe | Groupe Matière | Gruppo Materiali | 材质主类



Cutting Parameter

355

ALU LINE
 EZ LINE -
 ENDMILL
 SE 30
 NITICO 30
 OPTIMUM
 SE 45
 SE 45X
 NITICO 45
 SE 60
 SE 60X
 DN70 -
 SE 70
 SE GR
 TE 45
 PLUNGE
 -MILL
 THREAD
 MILL

Note: These recommended cutting data indicators are just for reference. They should be adjusted according to the different cutting condition



Thread Mill Endmills, 3 Flute - H15, H17, H19, H21

Thread Milling	N						K				S			
Working Material	Wrought Aluminium		Cast Aluminium		Copper alloy		Grey Cast Iron		Ductile Cast Iron		Titanium alloy		Nickel Alloy	
Properties	Si < 9%		Si ≥ 9%		-		-		-		-		-	
D	Vc	Fz	Vc	Fz	Vc	Fz	Vc	Fz	Vc	Fz	Vc	Fz	Vc	Fz
6	120	0.010	200	0.020	120	0.010	120	0.010	90	0.010	50	0.010	40	0.010
8		0.015		0.030		0.015		0.018		0.018		0.014		0.014

Thread Mill Endmills, 3 Flute - H15, H17, H19, H21

Thread Milling	P						M			
Working Material	Carbon steel		Alloy steel		Prehardened steel		Stainless steel		Stainless steel	
Properties	-		520 < Rm < 1200		35 ≤ HRC < 45		High Machinability		Low Machinability	
D	Vc	Fz	Vc	Fz	Vc	Fz	Vc	Fz	Vc	Fz
6	120	0.010	100	0.010	90	0.010	80	0.010	60	0.008
8		0.018		0.018		0.018		0.015		

Thread Mill Endmills, 4 Flute - H15, H17, H19, H21

Thread Milling	N						K				S			
Working Material	Wrought Aluminium		Cast Aluminium		Copper alloy		Grey Cast Iron		Ductile Cast Iron		Titanium alloy		Nickel Alloy	
Properties	Si < 9%		Si ≥ 9%		-		-		-		-		-	
D	Vc	Fz	Vc	Fz	Vc	Fz	Vc	Fz	Vc	Fz	Vc	Fz	Vc	Fz
10	120	0.020	200	0.040	120	0.020	120	0.026	90	0.026	50	0.012	40	0.013
12		0.025		0.050		0.025		0.034		0.034		0.015		0.016
14		0.030		0.060		0.030		0.042		0.042		0.018		0.018
16		0.035		0.070		0.035		0.050		0.050		0.021		0.021

Thread Mill Endmills, 4 Flute - H15, H17, H19, H21

Thread Milling	P						M			
Working Material	Carbon steel		Alloy steel		Prehardened steel		Stainless steel		Stainless steel	
Properties	-		520 < Rm < 1200		35 ≤ HRC < 45		High Machinability		Low Machinability	
D	Vc	Fz	Vc	Fz	Vc	Fz	Vc	Fz	Vc	Fz
10	120	0.026	100	0.026	90	0.026	80	0.026	60	0.020
12		0.034		0.034		0.034		0.034		0.030
14		0.042		0.042		0.042		0.042		0.035
16		0.050		0.050		0.050		0.050		0.040

Thread Mill Endmills, 5 Flute - H15, H17, H19, H21

Thread Milling	N						K				S			
Working Material	Wrought Aluminium		Cast Aluminium		Copper alloy		Grey Cast Iron		Ductile Cast Iron		Titanium alloy		Nickel Alloy	
Properties	Si < 9%		Si ≥ 9%		-		-		-		-		-	
D	Vc	Fz	Vc	Fz	Vc	Fz	Vc	Fz	Vc	Fz	Vc	Fz	Vc	Fz
18	120	0.035	200	0.070	120	0.035	120	0.050	90	0.050	50	0.021	40	0.021
20		0.040		0.080		0.040		0.055		0.055		0.025		0.025

Thread Mill Endmills, 5 Flute - H15, H17, H19, H21

Thread Milling	P						M			
Working Material	Carbon steel		Alloy steel		Prehardened steel		Stainless steel		Stainless steel	
Properties	-		520 < Rm < 1200		35 ≤ HRC < 45		High Machinability		Low Machinability	
D	Vc	Fz	Vc	Fz	Vc	Fz	Vc	Fz	Vc	Fz
18	120	0.050	100	0.050	90	0.050	80	0.050	60	0.040
20		0.055		0.055		0.058		0.055		0.045

ALU LINE
 EZ LINE - ENDMILL
 SE 30
 NITCo 30
 OPTIMUM
 SE 45
 SE 45X
 NITCo 45
 SE 60
 SE 60X
 DM70 - SE70
 SE GR
 TE 45
 PLUNGE -MILL
 THREAD MILL

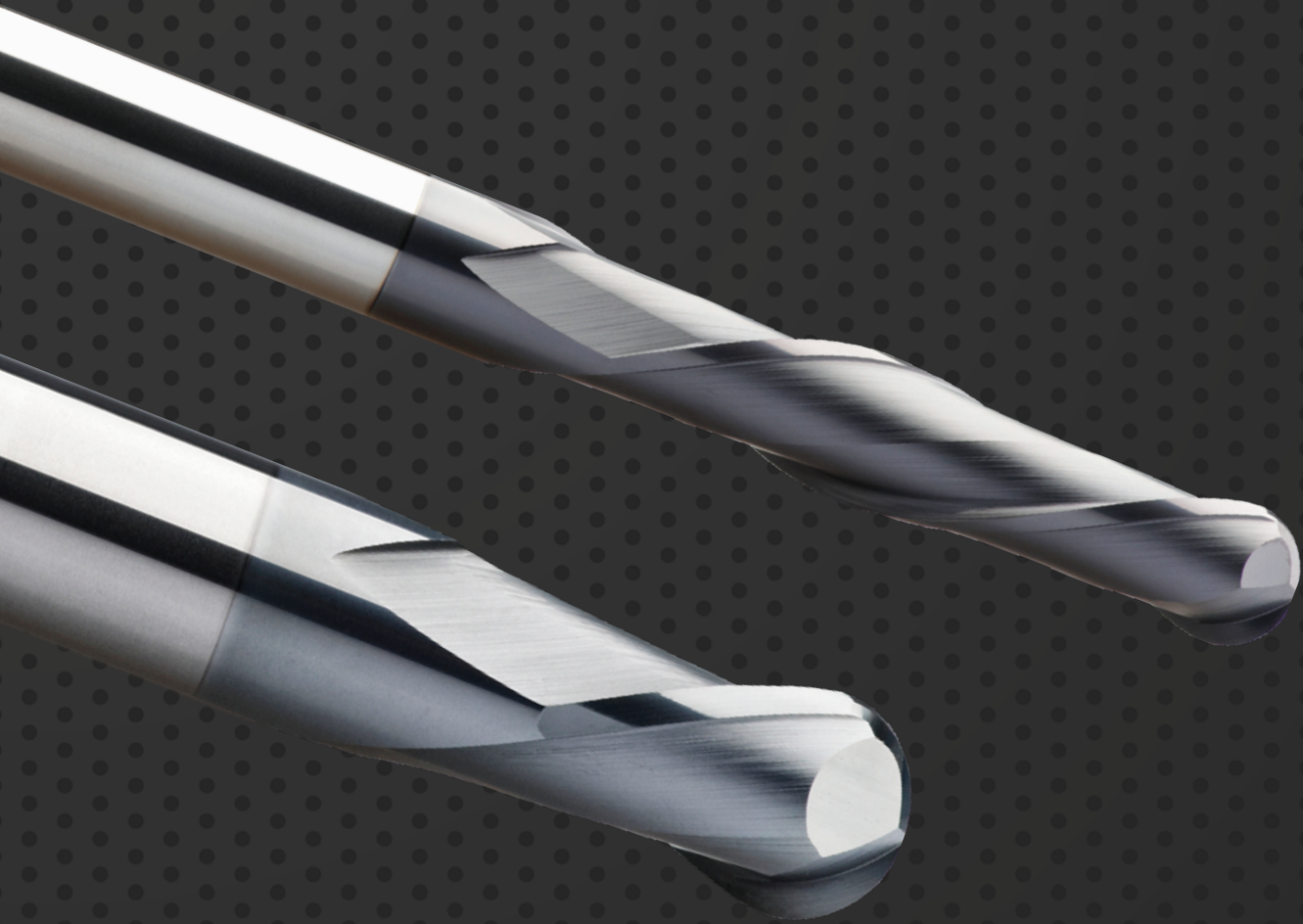

BALLNOSE

BN 30



For general machining

For material application ≤ 35 HRC

Index - BN 30, For ≤ 35 HRC

Suitable for Material Groups
 Adapté pour les matériaux
 适用于材料
 Geeignet für die Materialgruppen
 Adatto per il materiale

P	M	K
N	S	O

EDP Number	Type	No. Z	Helix Angle	Coating	Performance	Page Number
923 	BN 30	2	30°	B0819	G	360
925 	BN 30 Long	2	30°	B0819	G	361
927 	BN 30 Extra-Long	2	30°	B0819	G	362

G - General P - Performance

FEATURES & BENEFITS

BN 30

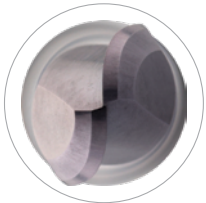

Top View

1 Eccentric Grinding

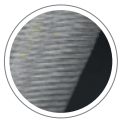

Optimum eccentric grinding in order to avoid rubbing, while maintaining maximum cutting tool strength.

2 Cutting Edge Preparation



- Enhances tool life
- Less material adhere on the cutting edge for stable machining
- Improves wear resistance and reduces excessive friction

3 Superior Coating to Reduce Friction

- Increases hardness and higher abrasive wear resistance
- Higher thermal resistance
- Smoother chips evacuation

4 Suitable for Material Groups





1. Exzentrischer Schliff
Optimaler exzentrischer Schliff zur Reduzierung der Reibung unter Beibehaltung der maximalen Schneidstabilität
2. Schneidkantenbehandlung
Verbessert die Werkzeuglebensdauer
Weniger Materialanhaftungen an der Schneide Für stabile Bearbeitung
3. Ausgezeichnete Beschichtung zur Verringerung der Reibung
Erhöht die Härte und und bietet bessere Verschleißfestigkeit
Höhere Temperaturbeständigkeit
Glatte Oberfläche für besseren Spänefluß
4. Positiver Spanwinkel
Geeignet für die Materialgruppen P, M, K, N, S, O



1. 偏心研磨
最佳偏心研磨,可避免摩擦,同时保持最大切削刀具强度。
2. 切削刃设置提高刀具寿命
提高刀具寿命。
较少的材料粘在切削刃上。
用于稳定加工。
3. 优异的涂层,减少摩擦
增加硬度,提高材料耐磨性。
更高的抗热性。
更顺畅的排屑。
4. 正前角
适用于材料 P、M、K、N、S、O。



1. Levigatura orbitale
Levigatura orbitale ottimale per evitare sfregatura, garantendo la massima resistenza dello strumento di taglio.
2. Preparazione dell'angolo di taglio
Migliora la durata dello strumento
Meno materiale che aderisce sull'angolo di taglio
Per una lavorazione stabile
3. Rivestimento superiore per ridurre la frizione
Aumenta la durezza e una maggiore resistenza all'usura abrasiva
Resistenza termica superiore
Evacuazione dei trucioli più semplice
4. Angolo di taglio positivo
Adatto per il materiale P, M, K, N, S, O



1. Meulage excentrique
Meulage optimal diminuant le coefficient de friction tout en maintenant une bonne acuité de l'arête de coupe
2. Préparation des arêtes de coupes
Améliore la durée de vie de l'outil
Moins de matériau adhère à l'arête tranchante
Pour un usinage stable
3. Revêtement supérieur pour réduire la friction
Augmente la dureté et la résistance à l'abrasion
Résistance thermique supérieure
Évacuation des copeaux plus fluide
4. Angle de coupe positif
Adapté pour les matériaux P, M, K, N, S, O

BN 30 BALLNOSE CUTTERS, 2 FLUTES

- VHM BN 30 Standard Radiuschaftfräser, 2 Zähne
- Frese sferiche BN 30, 2 taglienti
- Fraises BN 30, à bout hémisphérique, 2 dents
- 整体硬质合金 BN 30 系列 2刃球头铣刀



Order Number	Dimension (mm)						B0819
	D	R	I1	I2	L	d2 (h6)	
923 0300	3	1.5	9		40	3	•
923 0300 050 06			9		50	6	•
923 0400	4	2	14		50	4	•
923 0400 050 06			14		50	6	◦
923 0500	5	2.5	15		50	5	•
923 0500 050 06			15		50	6	•
923 0600 060	6	3	20		60	6	◦
923 0800	8	4	20		64	8	•
923 1000 070	10	5	22		70	10	◦
923 1000 075			22		75	10	•
923 1200	12	6	25		75	12	•
923 1400	14	7	30		90	14	◦
923 1600	16	8	30		90	16	◦
923 1800	18	9	38		100	18	◦
923 2000	20	10	38		100	20	•

BN 30
BN 45
BN 60
BN 60X
DM70 - BN 70
BN GR

Material Group | Material-Gruppe | Groupe Matière | Gruppo Materiali | 材质主类

Cutting Parameter



363

BN 30 LONG BALLNOSE CUTTERS, 2 FLUTES

- VHM BN 30 Radiusschaftfräser, lang, 2 Zähne
- Frese sferiche lunghe BN 30, 2 taglienti
- Fraises BN 30 longues, à bout hémisphérique, 2 dents
- 整体硬质合金 BN 30 系列 2刃长型球头铣刀



Order Number	Dimension (mm)						B0819
	D	R	I1	I2	L	d2 (h6)	
925 0300	3	15	19		60	3	•
925 0300 075 06			19		75	6	•
925 0400	4	2	19		60	4	•
925 0400 075 06			19		75	6	◦
925 0500	5	2.5	19		60	5	◦
925 0500 075 06			19		75	6	◦
925 0600	6	3	31		75	6	•
925 0800	8	4	31		75	8	◦
925 1000 075	10	5	31		75	10	◦
925 1000 100			31		100	10	◦
925 1200	12	6	50		100	12	•
925 1400	14	7	57		125	14	◦
925 1600	16	8	57		125	16	•
925 1800	18	9	57		125	18	◦
925 2000	20	10	57		125	20	◦

Material Group | Material-Gruppe | Groupe Matière | Gruppo Materiali | 材质主类

Cutting Parameter

N01	N02	N03	K01	K02	P01	P02	P03	M01	M02	S01	S02	S03	H01	H02	O01	O02	364
○	○	○	●	○	●	●	○	●	○	●	○	○	○	○	○	○	

BN 30 EXTRA-LONG BALLNOSE CUTTERS, 2 FLUTES

- VHM BN 30 Radiuschaftfräser, extra-lang, 2 Zähne
- Frese sferiche extra-lunghe BN 30, 2 taglienti
- Fraises BN 30 extra-longues, à bout hémisphérique, 2 dents
- 整体硬质合金 BN 30 系列 2刃加长型球头铣刀



Order Number	Dimension (mm)						B0819
	D	R	I 1	I 2	L	d2 (h6)	
927 0300	3	1.5	25		100	3	•
927 0300 100 06			25		100	6	◦
923 0400	4	2	31		100	4	•
923 0400 100 06			31		100	6	◦
923 0500	5	2.5	31		100	5	◦
923 0500 100 06			31		100	6	◦
923 0600 100	6	3	38		100	6	•
923 0600 150			38		150	6	◦
923 0800 100	8	4	41		100	8	•
923 0800 150			41		150	8	•
923 1000 125	10	5	45		125	10	◦
923 1000 150			45		150	10	•
923 1200 125	12	6	75		125	12	•
923 1200 150			75		150	12	◦
923 1400 150	14	7	75		150	14	◦
923 1400 200			75		200	14	◦
923 1600 150	16	8	75		150	16	◦
923 1600 200			75		200	16	◦
923 1800 150	18	9	75		150	18	◦
923 1800 200			75		200	18	◦
923 2000 150	20	10	75		150	20	◦
927 2000 200			75		200	20	◦

BN 30
BN 45
BN 60
BN 60X
DM70 -
BN 70
BN GR

Material Group | Material-Gruppe | Groupe Matière | Gruppo Materiali | 材质主类

N01
 N02
 N03
 K01
 K02
 P01
 P02
 P03
 M01
 M02
 S01
 S02
 S03
 H01
 H02
 O01
 O02

Cutting Parameter

365

Recommended Cutting Data



Note: These recommended cutting data indicators are just for reference. They should be adjusted according to the different cutting condition



BN 30 Ballnose Cutters, 2 Flutes - 923

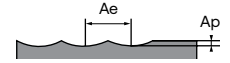

Finishing	K		P		M		S			
Working Material	Grey Cast Iron		Carbon Steel		Alloy steel		Stainless steel		Titanium	
Properties	-		-		520 < Rm < 1200		High Machinability		-	
Cutting depth, ap	0.10xD		0.120xD		0.100xD		0.110xD		0.110xD	
Cutting Width, ae	0.110xD		0.120xD		35 ≤ HRC < 45		0.110xD		0.110xD	
D	Vc	Fz	Vc	Fz	Vc	Fz	Vc	Fz	Vc	Fz
3	170	0.060	220	0.075	220	0.075	90	0.060	60	0.050
4		0.070		0.090		0.090		0.070		0.060
5		0.080		0.100		0.100		0.080		0.070
6		0.090		0.105		0.110		0.085		0.070
8		0.100		0.125		0.125		0.100		0.085
10		0.115		0.145		0.145		0.115		0.100
12		0.120		0.150		0.150		0.120		0.100
14		0.130		0.165		0.165		0.130		0.105
16		0.145		0.175		0.180		0.140		0.105
18		0.150		0.190		0.190		0.150		0.110
20		0.160		0.200		0.200		0.160		0.110

BN 30 Ballnose Cutters, 2 Flutes - 923

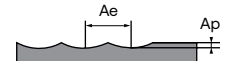

Finishing	K		P		M		S			
Working Material	Grey Cast Iron		Carbon Steel		Alloy steel		Stainless steel		Titanium	
Properties	-		-		520 < Rm < 1200		High Machinability		-	
Cutting depth, ap	0.022xD		0.025xD		0.020xD		0.025xD		0.025xD	
Cutting Width, ae	0.022xD		0.025xD		0.020xD		0.025xD		0.025xD	
D	Vc	Fz	Vc	Fz	Vc	Fz	Vc	Fz	Vc	Fz
3	250	0.025	320	0.040	320	0.035	125	0.035	70	0.030
4		0.045		0.065		0.055		0.055		0.050
5		0.050		0.070		0.060		0.060		0.055
6		0.050		0.080		0.065		0.065		0.060
8		0.060		0.090		0.075		0.075		0.070
10		0.065		0.095		0.080		0.080		0.070
12		0.070		0.100		0.085		0.085		0.075
14		0.075		0.115		0.090		0.090		0.075
16		0.080		0.125		0.100		0.100		0.080
18		0.090		0.135		0.110		0.110		0.080
20		0.100		0.140		0.120		0.120		0.090

Recommended Cutting Data



Note: These recommended cutting data indicators are just for reference. They should be adjusted according to the different cutting condition



BN 30 Long Ballnose Cutters, 2 Flutes - 925

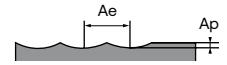

Roughing	K		P		M		S			
Working Material	Grey Cast Iron		Carbon Steel		Alloy steel		Stainless steel		Titanium	
Properties	-		-		520 < Rm < 1200		High Machinability		-	
Cutting depth, ap	0.080xD		0.080xD		0.080xD		0.080xD		0.080xD	
Cutting Width, ae	0.080xD		0.080xD		0.080xD		0.080xD		0.080xD	
D	Vc	Fz	Vc	Fz	Vc	Fz	Vc	Fz	Vc	Fz
3	170	0.060	220	0.070	220	0.075	90	0.055	60	0.045
4		0.065		0.075		0.080		0.060		0.050
5		0.070		0.090		0.090		0.070		0.060
6		0.080		0.095		0.100		0.075		0.065
8		0.090		0.105		0.110		0.085		0.070
10		0.105		0.125		0.130		0.100		0.085
12		0.110		0.130		0.135		0.105		0.090
14		0.115		0.140		0.145		0.115		0.100
16		0.125		0.150		0.155		0.120		0.105
18		0.130		0.160		0.165		0.130		0.115
20	0.145	0.170	0.180	0.140	0.120					

BN 30 Long Ballnose Cutters, 2 Flutes - 925

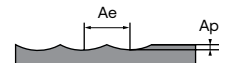

Finishing	K		P		M		S			
Working Material	Grey Cast Iron		Carbon Steel		Alloy steel		Stainless steel		Titanium	
Properties	-		-		520 < Rm < 1200		High Machinability		-	
Cutting depth, ap	0.020xD		0.020xD		0.020xD		0.020xD		0.020xD	
Cutting Width, ae	0.020xD		0.020xD		0.020xD		0.020xD		0.020xD	
D	Vc	Fz	Vc	Fz	Vc	Fz	Vc	Fz	Vc	Fz
3	250	0.025	320	0.035	320	0.030	125	0.030	70	0.025
4		0.040		0.060		0.050		0.050		0.045
5		0.045		0.065		0.055		0.055		0.050
6		0.050		0.070		0.060		0.060		0.055
8		0.050		0.080		0.065		0.065		0.060
10		0.055		0.085		0.070		0.070		0.065
12		0.060		0.090		0.075		0.075		0.070
14		0.070		0.100		0.085		0.085		0.080
16		0.070		0.110		0.090		0.090		0.085
18		0.080		0.120		0.100		0.100		0.095
20	0.085	0.130	0.105	0.105	0.100					

BN 30
BN 45
BN 60
BN 60X
DM70 -
BN 70
BN GR

Recommended Cutting Data



Note: These recommended cutting data indicators are just for reference. They should be adjusted according to the different cutting condition



BN 30 Extra-Long Ballnose Cutters, 2 Flutes - 927

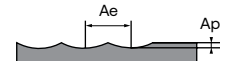

Roughing	K		P		M		S			
Working Material	Grey Cast Iron		Carbon Steel		Alloy steel		Stainless steel		Titanium	
Properties	-		-		520 < Rm < 1200		High Machinability		-	
Cutting depth, ap	0.020xD		0.020xD		0.020xD		0.020xD		0.020xD	
Cutting Width, ae	0.020xD		0.020xD		0.020xD		0.020xD		0.020xD	
D	Vc	Fz	Vc	Fz	Vc	Fz	Vc	Fz	Vc	Fz
3	145	0.036	190	0.042	190	0.045	75	0.033	50	0.027
4		0.039		0.045		0.048		0.036		0.030
5		0.042		0.054		0.054		0.042		0.036
6		0.048		0.057		0.060		0.045		0.039
8		0.054		0.063		0.066		0.051		0.042
10		0.063		0.075		0.078		0.060		0.051
12		0.066		0.078		0.081		0.063		0.054
14		0.069		0.084		0.087		0.069		0.060
16		0.075		0.090		0.093		0.072		0.063
18		0.078		0.096		0.099		0.078		0.069
20		0.087		0.102		0.108		0.084		0.072

BN 30 Extra-Long Ballnose Cutters, 2 Flutes - 927

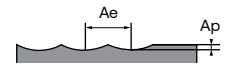

Finishing	K		P		M		S			
Working Material	Grey Cast Iron		Carbon Steel		Alloy steel		Stainless steel		Titanium	
Properties	-		-		520 < Rm < 1200		High Machinability		-	
Cutting depth, ap	0.005xD		0.005xD		0.005xD		0.005xD		0.005xD	
Cutting Width, ae	0.005xD		0.005xD		0.005xD		0.005xD		0.005xD	
D	Vc	Fz	Vc	Fz	Vc	Fz	Vc	Fz	Vc	Fz
3	210	0.015	270	0.021	270	0.018	110	0.018	60	0.015
4		0.024		0.036		0.030		0.030		0.027
5		0.027		0.039		0.033		0.033		0.030
6		0.030		0.042		0.036		0.036		0.033
8		0.030		0.048		0.039		0.039		0.036
10		0.033		0.051		0.042		0.042		0.039
12		0.036		0.054		0.045		0.045		0.042
14		0.042		0.060		0.051		0.051		0.048
16		0.042		0.066		0.054		0.054		0.051
18		0.048		0.072		0.060		0.060		0.057
20		0.051		0.078		0.063		0.063		0.060



BALLNOSE

BN 45

For general machining

For material application between 36 HRC to 52 HRC

Index - BN 45, For 36 - 52 HRC

Suitable for Material Groups

Adapté pour les matériaux

适用于材料

Geeignet für die Materialgruppen

Adatto per il materiale

P	M	K
S	H	

NEW

EDP Number	Type	No. Z	Helix Angle	Coating	Performance	Page Number
929	BN 45	2	30°	B0819	G	370
C36	BN 45	2	30°	G6110	G	370
F38	BN 45, Recess	2	30°	B0819	G	371
B82	BN 45	4	30°	B0819	G	372
931	BN 45 Long	2	30°	B0819	G	373
933	BN 45 Extra-Long	2	30°	B0819	G	374
940	BN 45	2	30°	B0819	G	375
941	BN 45, Recess	2	30°	B0819	G	375
A57	BN 45	2	30°	B0909	G	375
A58	BN 45, Recess	2	30°	B0909	G	375
485	BN 45	4	30°	G6110	G	376
942	BN 45 Long	2	30°	B0819	G	377
943	BN 45 Long, Recess	2	30°	B0819	G	377
A59	BN 45 Long	2	30°	B0909	G	377
A60	BN 45 Long, Recess	2	30°	B0909	G	377
944	BN 45 Extra-Long	2	30°	B0819	G	378
945	BN 45 Extra-Long, Recess	2	30°	B0819	G	379
A61	BN 45 Extra-Long	2	30°	B0909	G	378
A62	BN 45 Extra-Long, Recess	2	30°	B0909	G	379
935	BN 45 Mini	2	30°	B0819	G	380
A63	BN 45 Mini	2	30°	B0909	G	380
A65	BN 45 Miniature Long Neck	2	30°	B0909	G	381
937	BN 45 Miniature Long Neck	2	30°	B0819	G	382
A76	BN 45 Miniature Long Neck	2	30°	B0909	G	382
A78	BN 45 Taper Neck	2	30°	B0909	G	384

G - General P - Performance

FEATURES & BENEFITS

BN 45



Top View

1 Eccentric Grinding

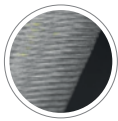

Optimum eccentric grinding in order to avoid rubbing, while maintaining maximum cutting tool strength.

2 Cutting Edge Preparation



- Enhances tool life
- Less material adhere on the cutting edge for stable machining
- Improves wear resistance and reduces excessive friction

3 Superior Coating to Reduce Friction

- Increases hardness and higher abrasive wear resistance
- Higher thermal resistance
- Smoother chips evacuation

4 Suitable for Material Groups





1. Exzentrischer Schliff
Optimaler exzentrischer Schliff zur Reduzierung der Reibung unter Beibehaltung der maximalen Schneidstabilität
2. Schneidkantenbehandlung
Verbessert die Werkzeuglebensdauer
Weniger Materialanhaftungen an der Schneide Für stabile Bearbeitung
3. Ausgezeichnete Beschichtung zur Verringerung der Reibung
Erhöht die Härte und und bietet bessere Verschleißfestigkeit
Höhere Temperaturbeständigkeit
Glatte Oberfläche für besseren Spänefluß
4. Positiver Spanwinkel
Geeignet für die Materialgruppen P, M, K, S, H



1. 偏心研磨
最佳偏心研磨,可避免摩擦,同时保持最大切削刀具强度。
2. 切削刃设置提高刀具寿命
提高刀具寿命。
较少的材料粘在切削刃上。
用于稳定加工。
3. 优异的涂层,减少摩擦
增加硬度,提高材料耐磨性。
更高的抗热性。
更顺畅的排屑。
4. 正前角
适用于材料 P、M、K、S、H。







1. Levigatura orbitale
Levigatura orbitale ottimale per evitare sfregatura, garantendo la massima resistenza dello strumento di taglio.
2. Preparazione dell'angolo di taglio
Migliora la durata dello strumento
Meno materiale che aderisce sull'angolo di taglio
Per una lavorazione stabile
3. Rivestimento superiore per ridurre la frizione
Aumenta la durezza e una maggiore resistenza all'usura abrasiva
Resistenza termica superiore
Evacuazione dei trucioli più semplice
4. Angolo di taglio positivo
Adatto per il materiale P, M, K, S, H



1. Meulage excentrique
Meulage optimal diminuant le coefficient de friction tout en maintenant une bonne acuité de l'arête de coupe
2. Préparation des arêtes de coupes
Améliore la durée de vie de l'outil
Moins de matériau adhère à l'arête tranchante
Pour un usinage stable
3. Revêtement supérieur pour réduire la friction
Augmente la dureté et la résistance à l'abrasion
Résistance thermique supérieure
Évacuation des copeaux plus fluide
4. Angle de coupe positif
Adapté pour les matériaux P, M, K, S, H

BN 45 BALLNOSE CUTTERS, 2 FLUTES

-  VHM BN 45 Standard Radiuschaftfräser, 2 Zähne
-  Frese sferiche BN 45, 2 taglienti
-  Fraises BN 45 , à bout hémisphérique, 2 dents
-  整体硬质合金 BN 45 系列 2刃球头铣刀



Order Number	Dimension (mm)						G6110	Order Number	Dimension (mm)						B0819
	D	R	I1	I2	L	d2 (h6)			D	R	I1	I2	L	d2 (h6)	
C36 0100 040 03	1	0.5	3		40	3	•	929 0100 040 03	1	0.5	3		40	3	•
C36 0100 050 04					50	4	◦	929 0100 050 04					50	4	•
C36 0150 040 03	1.5	0.75	3		40	3	◦	929 0150 040 03	1.5	0.75	3		40	3	•
C36 0150 050 04					50	4	◦	929 0150 050 04					50	4	•
C36 0200 040 03	2	1	4		40	3	◦	929 0200 040 03	2	1	4		40	3	•
C36 0200 050 04					50	4	◦	929 0200 050 04					50	4	•
C36 0250 040 03	2.5	1.25	4		40	3	◦	929 0250 040 03	2.5	1.25	4		40	3	•
C36 0250 050 04					50	4	◦	929 0250 050 04					50	4	•
C36 0300	3	1.5	5		40	3	•	929 0300	3	1.5	5		40	3	•
C36 0300 050 04					50	4	◦	929 0300 050 04					50	4	•
C36 0300 050 06	3.5	1.75	8		50	6	•	929 0300 050 06	3.5	1.75	8		50	6	•
C36 0350 050 04					50	4	◦	929 0350 050 04					50	4	•
C36 0400	4	2	9		50	4	◦	929 0400	4	2	9		50	4	•
C36 0400 050 06					50	6	•	929 0400 050 06					50	6	•
C36 0450 050 05	4.5	2.25	9		50	5	◦	929 0450 050 05	4.5	2.25	9		50	5	•
C36 0500	5	2.5			50	5	◦	929 0500	5	2.5			50	5	•
C36 0500 050 06	5.5	2.75	10		50	6	◦	929 0500 050 06	5.5	2.75	10		50	6	•
C36 0550 050 06					50	6	◦	929 0550 050 06					50	6	•
C36 0600 050	6	3	12		50	6	◦	929 0600 050	6	3	12		50	6	•
C36 0600 060					60	6	◦	929 0600 060					60	6	•
C36 0700 064 08	7	3.5	12		64	8	◦	929 0700 064 08	7	3.5	12		64	8	•
C36 0800	8	4			64	8	•	929 0800	8	4			64	8	•
C36 0900 070 10	9	4.5	14		70	10	◦	929 0900 070 10	9	4.5	14		70	10	•
C36 1000 070	10	5			70	10	•	929 1000 070	10	5			70	10	•
C36 1000 075	10	5	16		75	10	•	929 1000 075	10	5	16		75	10	•
C36 1100 075 12					75	12	◦	929 1100 075 12					75	12	•
C36 1200	12	6	32		75	12	•	929 1200	12	6	32		75	12	•
C36 1400	14	7			90	14	◦	929 1400	14	7			90	14	•
C36 1600	16	8	38		90	16	◦	929 1600	16	8	38		90	16	•
C36 1800	18	9			100	18	◦	929 1800	18	9			100	18	•
C36 2000	20	10	40		100	20	◦	929 2000	20	10	40		100	20	•
C36 2200	22	11			100	22	◦	929 2200	22	11			100	22	•
C36 2500	25	12.5			100	25	◦	929 2500	25	12.5			100	25	◦

cont'd ▶

Material Group | Material-Gruppe | Groupe Matière | Gruppo Materiali | 材质主类

Cutting Parameter

N01	N02	N03	K01	K02	P01	P02	P03	M01	M02	S01	S02	S03	H01	H02	O01	O02
-----	-----	-----	-----	-----	-----	-----	-----	-----	-----	-----	-----	-----	-----	-----	-----	-----

386

BN 45 BALLNOSE CUTTERS WITH RECESS, 2 FLUTES

- VHM BN 45 Standard Radiusschaftfräser, 2 Zähne
- Frese sferiche BN 45, 2 taglienti
- Fraises BN 45, à bout hémisphérique, 2 dents
- 整体硬质合金 BN 45 系列 2刃球头铣刀

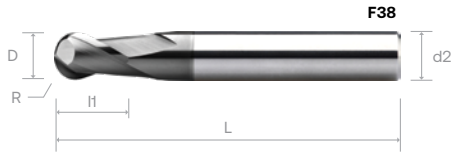

Order Number <small>DIN 6535</small>	Dimension (mm)						B0819	Order Number	Dimension (mm)						B0819	
	D	R	I1	I2	L	d2 (h6)			D	R	I1	I2	L	d2 (h6)		
F38 0100 040 03	1	0.5	3		40	3										
F38 0100 050 04					50	4										
F38 0150 040 03 *	1.5	0.75	3		40	3										
F38 0150 050 04 *					50	4										
F38 0200 040 03 *	2	1	4		40	3										
F38 0200 050 04 *					50	4										
F38 0250 040 03 *	2.5	1.25	4		40	3										
F38 0250 050 04					50	4										
F38 0300 *	3	1.5	5		40	3										
F38 0300 050 04					14	50	4	°								
F38 0300 050 06 *					14	50	6	°								
F38 0350 050 04 *	3.5	1.75	8		20	50	4	°								
F38 0400	4	2			20	50	4	°								
F38 0400 050 06	4.5	2.25	9		50	6										
F38 0450 050 05 *					20	50	5	°								
F38 0500	5	2.5	10		20	50	5	°								
F38 0500 050 06 *					50	6										
F38 0550 050 06 *	5.5	2.75	12		50	6										
F38 0600 050 *	6	3			24	60	6	°								
F38 0600 060	7	3.5	12		28	64	8	°								
F38 0700 064 08					28	64	8	°								
F38 0800	8	4	14		28	64	8	°								
F38 0900 070 10	9	4.5			30	70	10	°								
F38 1000 070	10	5	16		30	70	10	°								
F38 1000 075					30	75	10	°								
F38 1100 075 12	11	5.5	32		30	75	12	°								
F38 1200	12	6			30	75	12	°								
F38 1400	14	7	38		42	90	14	°								
F38 1600	16	8			42	90	16	°								
F38 1800	18	9	40		50	100	18	°								
F38 2000	20	10			50	100	20	°								
F38 2200	22	11			100	22										
F38 2500	25	12.5			100	25										

* - DIN 6535

Material Group | Material-Gruppe | Groupe Matière | Gruppo Materiali | 材质主类

Cutting Parameter

N01	N02	N03	K01	K02	P01	P02	P03	M01	M02	S01	S02	S03	H01	H02	O01	O02	386
			○	●	○	○	●	○	●	○	●	○	●	○	○	○	

BN 45 BALLNOSE CUTTERS, 4 FLUTES

- VHM BN 45 Standard Radiuschaftfräser, 4 Zähne
- Frese sferiche BN 45, 4 taglienti
- Fraises BN 45, à bout hémisphérique, 4 dents
- 整体硬质合金 BN 45 系列 4刃球头铣刀

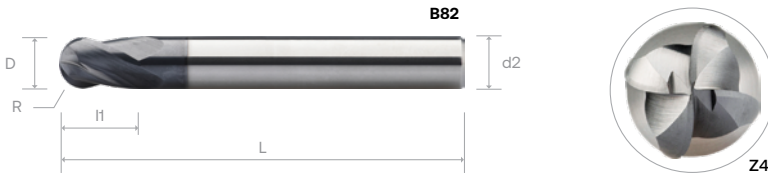

Order Number	Dimension (mm)						B0819
	D	R	I 1	I 2	L	d2 (h6)	
B82 0300	3	1.5	5		40	3	•
B82 0300 050 06					50	6	•
B82 0350 050 04	3.5	1.75	8		50	4	◦
B82 0400	4	2			50	4	•
B82 0400 050 06				50	6	•	
B82 0450 050 05	4.5	2.25	9		50	5	◦
B82 0500	5	2.5			50	5	◦
B82 0500 050 06				50	6	◦	
B82 0550 050 06	5.5	2.75	10		50	6	•
B82 0600 050	6	3			50	6	•
B82 0600 060				60	6	•	
B82 0700 064 08	7	3.5	12		64	8	◦
B82 0800	8	4			64	8	•
B82 0900 070 10	9	4.5	14		70	10	◦
B82 1000 070	10	5			70	10	•
B82 1000 075				75	10	◦	
B82 1100 075 12	11	5.5	16		75	12	◦
B82 1200	12	6			75	12	•
B82 1400	14	7	32		90	14	◦
B82 1600	16	8			90	16	◦
B82 1800	18	9	38		100	18	◦
B82 2000	20	10			100	20	◦
B82 2200	22	11	40		100	22	◦
B82 2500	25	12.5			100	25	◦

- BN 30
- BN 45
- BN 60
- BN 60X
- DM70 - BN70
- BN GR

Material Group | Material-Gruppe | Groupe Matière | Gruppo Materiali | 材质主类

Cutting Parameter

N01	N02	N03	K01	K02	P01	P02	P03	M01	M02	S01	S02	S03	H01	H02	O01	O02	387
○	○	○	●	●	○	○	●	○	●	○	●	○	●	○	○	○	

BN 45 LONG BALLNOSE CUTTERS, 2 FLUTES

- VHM BN 45 Radiuschaftfräser, lang, 2 Zähne
- Frese sferiche lunghe BN 45, 2 taglienti
- Fraises BN 45 longues, à bout hémisphérique, 2 dents
- 整体硬质合金 BN 45 系列 2刃长型球头铣刀

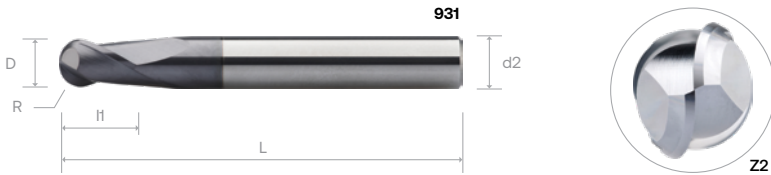

Order Number	Dimension (mm)						B0819		
	D	R	l1	l2	L	d2 (h6)			
931 0100 060 03	1	0.5	3		60	3	•		
931 0100 075 04	1	0.5				75	4	◦	
931 0150 060 03	1.5	0.75				60	3	◦	
931 0150 075 04						75	4	◦	
931 0200 060 03	2	1	4		60	3	◦		
931 0200 075 04							75	4	•
931 0250 060 03				2.5	1.25			60	3
931 0250 075 04						75	4	◦	
931 0300	3	1.5	5		60	3	•		
931 0300 075 04							75	4	◦
931 0300 075 06							75	6	◦
931 0400	4	2	8		60	4	•		
931 0400 075 06							75	6	•
931 0500	5	2.5	9		60	5	◦		
931 0500 075 06							75	6	•
931 0600	6	3	10		75	6	•		
931 0800	8	4	12		75	8	•		
931 1000 075	10	5	14		75	10	◦		
931 1000 100							100	10	•
931 1200	12	6	16		100	12	•		
931 1400	14	7	32		125	14	◦		
931 1600	16	8			125	16	◦		
931 1800	18	9	38		125	18	◦		
931 2000	20	10			125	20	◦		

Material Group | Material-Gruppe | Groupe Matière | Gruppo Materiali | 材质主类

Cutting Parameter

N01	N02	N03	K01	K02	P01	P02	P03	M01	M02	S01	S02	S03	H01	H02	O01	O02	388	
			○	●	○	○	●	○	●	○	●	○	●	○				

BN 45 EXTRA-LONG BALLNOSE CUTTERS, 2 FLUTES

- VHM BN 45 Radiuschaftfräser, extra-lang, 2 Zähne
- Frese sferiche extra-lunghe BN 45, 2 taglienti
- Fraises BN 45 extra-longues, à bout hémisphérique, 2 dents
- 整体硬质合金 BN 45 系列 2刃加长型球头铣刀



Order Number	Dimension (mm)						B0819
	D	R	I1	I2	L	d2 (h6)	
933 0100 100 03	1	0.5	3		100	3	○
933 0100 100 04					100	4	○
933 0150 100 03	1.5	0.75	3		100	3	○
933 0150 100 04					100	4	○
933 0200 100 03	2	1	4		100	3	●
933 0200 100 04					100	4	○
933 0250 100 03	2.5	1.25	4		100	3	○
933 0250 100 04					100	4	○
933 0300	3	1.5	5		100	3	●
933 0300 100 04					100	4	○
933 0300 100 06	4	2	8		100	6	○
933 0400					100	4	●
933 0400 100 06	5	2.5	9		100	6	○
933 0500					100	5	●
933 0500 100 06	6	3	10		100	6	○
933 0600 100					100	6	●
933 0600 150	8	4	12		150	6	●
933 0800 100					100	8	●
933 0800 150	10	5	14		150	8	○
933 1000 125					125	10	●
933 1000 150	12	6	16		150	10	○
933 1200 125					125	12	●
933 1200 150	14	7	32		150	12	○
933 1400 150					150	14	○
933 1400 200	16	8	38		200	14	○
933 1600 150					150	16	○
933 1600 200	18	9	38		200	16	●
933 1800 150					150	18	○
933 1800 200	20	10	38		200	18	○
933 2000 150					150	20	○
933 2000 200		200	20	○			

- BN 30
- BN 45
- BN 60
- BN 60X
- DM70 - BN 70
- BN GR

Material Group | Material-Gruppe | Groupe Matière | Gruppo Materiali | 材质主类

Cutting Parameter





N01	N02	N03	K01	K02	P01	P02	P03	M01	M02	S01	S02	S03	H01	H02	O01	O02
○	○	○	●	●	○	○	○	○	○	○	○	○	○	○	○	○

389

940 / 941 / A57 / A58



BN 45 BALLNOSE CUTTERS / WITH RECESS, 2 FLUTES

-  VHM BN 45 Standard Radiusschafffräser, 2 Zähne
-  Frese sferiche BN 45, 2 taglienti
-  Fraises BN 45, à bout hémisphérique, 2 dents
-  整体硬质合金 BN 45 系列 2 刃球头铣刀

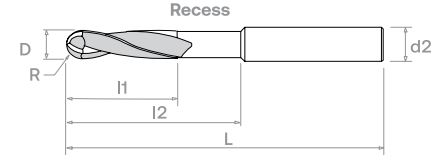
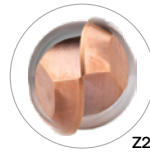

Order Number	Dimension (mm)						B0909	Order Number	Dimension (mm)						B0819
	D	R	I1	I2	L	d2 (h6)			D	R	I1	I2	L	d2 (h6)	
A57 0100 040 03	1	0.5	3		40	3	•	940 0100 040 03	1	0.5	3		40	3	◦
A57 0100 050 04					50	4	•	940 0100 050 04					50	4	◦
A57 0150 040 03	1.5	0.75		4		40	3	•	940 0150 040 03	1.5		0.75	4		40
A57 0150 050 04			50			4	•	940 0150 050 04	50		4				◦
A57 0200 040 03	2	1	4		40	3	•	940 0200 040 03	2	1	4		40	3	•
A57 0200 050 04					50	4	•	940 0200 050 04					50	4	◦
A57 0250 040 03	2.5	1.25		5		40	3	•	940 0250 040 03	2.5		1.25	5		40
A57 0250 050 04			50			4	•	940 0250 050 04	50		4				◦
A57 0300	3	1.5	5		40	3	•	940 0300	3	1.5	5		40	3	•
A57 0300 050 04					50	4	•	940 0300 050 04					50	4	◦
A57 0300 050 06	50	6		•	940 0300 050 06	50	6	◦							
A57 0400	4	2	8		50	4	•	940 0400	4	2	8		50	4	•
A57 0400 050 06					50	6	•	940 0400 050 06					50	6	•
A57 0500	50	5		•	940 0500	50	5	•							
A57 0500 050 06	5	2.5	9		50	6	•	940 0500 050 06	5	2.5	9		50	6	•
A57 0600 050					50	6	•	940 0600 050					50	6	•
A57 0600 060	60	6		•	940 0600 060	60	6	•							
A57 0800	8	4	12	64	8	•	940 0800	8	4	12	64	8	•		
A57 1000	10	5	14	70	10	•	940 1000	10	5	14	70	10	•		
A57 1200	12	6	16	75	12	•	940 1200	12	6	16	75	12	◦		
A57 1400	14	7	32	90	14	•	940 1400	14	7	32	90	14	•		
A57 1600	16	8		90	16	•	940 1600	16	8		90	16	•		
A57 1800	18	9	38	100	18	◦	940 1800	18	9	38	100	18	◦		
A57 2000	20	10		100	20	•	940 2000	20	10		100	20	◦		
A57 2200	22	11	40	100	22	•	940 2200	22	11	40	100	22	◦		
A57 2500	25	12.5		100	25	•	940 2500	25	12.5		100	25	◦		

Order Number	Dimension (mm)						B0909	Order Number	Dimension (mm)						B0819		
	D	R	I1	I2	L	d2 (h6)			D	R	I1	I2	L	d2 (h6)			
A58 0100 040 03	1	0.5	3		4	40	3	◦	941 0100 040 03	1	0.5	3		4	40	3	•
A58 0100 050 04					4	50	4	◦	941 0100 050 04					4	50	4	◦
A58 0150 040 03	1.5	0.75		4		6	40	3	◦	941 0150 040 03	1.5		0.75	4		6	40
A58 0150 050 04 *			6			50	4	◦	941 0150 050 04 *	6		50				4	•
A58 0200 040 03	2	1	4		8	40	3	◦	941 0200 040 03	2	1	4		8	40	3	•
A58 0200 050 04 *					8	50	4	•	941 0200 050 04 *					8	50	4	◦
A58 0250 040 03 *	2.5	1.25		5		10	40	3	◦	941 0250 040 03 *	2.5		1.25	5		10	40
A58 0250 050 04			10			50	4	◦	941 0250 050 04	10		50				4	◦
A58 0300	3	1.5	5		14	40	3	◦	941 0300	3	1.5	5		14	40	3	•
A58 0300 050 04					14	50	4	◦	941 0300 050 04					14	50	4	•
A58 0300 050 06	14	50		6	◦	941 0300 050 06	14	50	6	•							
A58 0400 *	4	2	8		20	50	4	◦	941 0400 *	4	2	8		20	50	4	•
A58 0400 050 06					20	50	6	◦	941 0400 050 06					20	50	6	◦
A58 0500 *	20	50		5	◦	941 0500 *	20	50	5	◦							
A58 0500 050 06	5	2.5	9		20	50	6	•	941 0500 050 06	5	2.5	9		20	50	6	•
A58 0600 050					20	50	6	•	941 0600 050					20	50	6	•
A58 0600 060	30	60		6	•	941 0600 060	30	60	6	•							
A58 0800	8	4	12	30	64	8	•	941 0800	8	4	12	30	64	8	•		
A58 1000	10	5	14	32	70	10	•	941 1000	10	5	14	32	70	10	•		
A58 1200	12	6	16	38	75	12	•	941 1200	12	6	16	38	75	12	•		
A58 1400 *	14	7	32	44	90	14	◦	941 1400 *	14	7	32	44	90	14	◦		
A58 1600	16	8		46	90	16	•	941 1600	16	8		46	90	16	•		
A58 1800	18	9	38	53	100	18	•	941 1800	18	9	38	53	100	18	◦		
A58 2000	20	10		58	100	20	•	941 2000	20	10		58	100	20	◦		
A58 2200	22	11	40	58	100	22	•	941 2200	22	11	40	58	100	22	◦		
A58 2500	25	12.5		58	100	25	◦	941 2500	25	12.5		58	100	25	◦		

* - DIN 6535

Material Group | Material-Gruppe | Groupe Matière | Gruppo Materiali | 材质主类

Cutting Parameter

N01	N02	N03	K01	K02	P01	P02	P03	M01	M02	S01	S02	S03	H01	H02	O01	O02	386
-----	-----	-----	-----	-----	-----	-----	-----	-----	-----	-----	-----	-----	-----	-----	-----	-----	-----

BN 45 BALLNOSE CUTTERS, 4 FLUTES

- VHM BN 45 Standard Radiuschaftfräser, 4 Zähne
- Frese sferiche BN 45, 4 taglienti
- Fraises BN 45, à bout hémisphérique, 4 dents
- 整体硬质合金 BN 45 系列 4刃球头铣刀



Order Number	Dimension (mm)						G6110
	D	R	I1	I2	L	d2 (h6)	
485 0300	3	1.5	5		40	3	•
485 0300 050 06					50	6	•
485 0400	4	2	8		50	4	•
485 0400 050 06					50	6	◦
485 0500	5	2.5	9		50	5	•
485 0500 050 06					50	6	◦
485 0600 050	6	3	10		50	6	•
485 0600 060					60	6	•
485 0800	8	4	12		64	8	•
485 1000	10	5	14		70	10	◦
485 1200	12	6	16		75	12	•
485 1400	14	7			90	14	◦
485 1600	16	8	32		90	16	◦
485 1800	18	9			100	18	◦
485 2000	20	10	38		100	20	◦
485 2200	22	11			100	22	◦
485 2500	25	12.5	40		100	25	◦

- BN 30
- BN 45
- BN 60
- BN 60X
- DM70 - BN70
- BN GR

Material Group | Material-Gruppe | Groupe Matière | Gruppo Materiali | 材质主类

Cutting Parameter

N01
 N02
 N03
 K01
 K02
 P01
 P02
 P03
 M01
 M02
 S01
 S02
 S03
 H01
 H02
 O01
 O02

387



BN 45 LONG BALLNOSE CUTTERS / WITH RECESS, 2 FLUTES

- VHM BN 45 Radiusschafffräser, lang, 2 Zähne
- Frese sferiche lunghe BN 45, 2 taglienti
- Fraises BN 45 longues, à bout hémisphérique, 2 dents
- 整体硬质合金 BN 45 系列 2刃长型球头铣刀

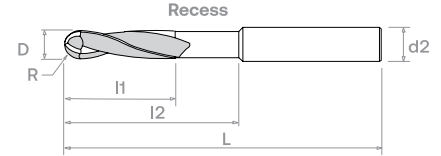
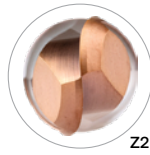

Order Number	Dimension (mm)						B0909	Order Number	Dimension (mm)						B0819
	D	R	I1	I2	L	d2 (h6)			D	R	I1	I2	L	d2 (h6)	
A59 0100 060 03	1	0.5	3		60	3	○	942 0100 060 03	1	0.5	3		60	3	○
A59 0100 075 04					75	4	●	942 0100 075 04					75	4	○
A59 0150 060 03	1.5	0.75	3		60	3	●	942 0150 060 03	1.5	0.75	3		60	3	○
A59 0150 075 04					75	4	●	942 0150 075 04					75	4	○
A59 0200 060 03	2	1	4		60	3	○	942 0200 060 03	2	1	4		60	3	●
A59 0200 075 04					75	4	●	942 0200 075 04					75	4	●
A59 0250 060 03	2.5	1.25	4		60	3	○	942 0250 060 03	2.5	1.25	4		60	3	○
A59 0250 075 04					75	4	○	942 0250 075 04					75	4	●
A59 0300	3	1.5	5		60	3	●	942 0300	3	1.5	5		60	3	○
A59 0300 075 06					75	6	●	942 0300 075 06					75	6	●
A59 0400	4	2	8		60	4	●	942 0400	4	2	8		60	4	●
A59 0400 075 06					75	6	●	942 0400 075 06					75	6	●
A59 0500	5	2.5	9		60	5	●	942 0500	5	2.5	9		60	5	○
A59 0500 075 06					75	6	●	942 0500 075 06					75	6	○
A59 0600	6	3	10		75	6	●	942 0600	6	3	10		75	6	●
A59 0600 075 06					75	6	●	942 0600 075 06					75	6	●
A59 0800	8	4	12		75	8	●	942 0800	8	4	12		75	8	○
A59 0800 075 06					75	8	○	942 0800 075 06					75	8	○
A59 1000 075	10	5	14		75	10	●	942 1000 075	10	5	14		75	10	○
A59 1000 100					100	10	●	942 1000 100					100	10	●
A59 1200	12	6	16		100	12	●	942 1200	12	6	16		100	12	○
A59 1200 075 06					100	12	●	942 1200 075 06					100	12	○
A59 1400	14	7	32		125	14	●	942 1400	14	7	32		125	14	○
A59 1400 075 06					125	14	○	942 1400 075 06					125	14	○
A59 1600	16	8	38		125	16	●	942 1600	16	8	38		125	16	○
A59 1600 075 06					125	16	○	942 1600 075 06					125	16	○
A59 1800	18	9	38		125	18	●	942 1800	18	9	38		125	18	○
A59 1800 075 06					125	18	○	942 1800 075 06					125	18	○
A59 2000	20	10			125	20	●	942 2000	20	10			125	20	●
A59 2000 075 06					125	20	○	942 2000 075 06					125	20	○

Order Number	Dimension (mm)						B0909	Order Number	Dimension (mm)						B0819		
	D	R	I1	I2	L	d2 (h6)			D	R	I1	I2	L	d2 (h6)			
A60 0100 060 03	1	0.5	3		7	60	3	○	943 0100 060 03	1	0.5	3		7	60	3	○
A60 0100 075 04					7	75	4	○	943 0100 075 04					7	75	4	○
A60 0150 060 03	1.5	0.75	3		10	60	3	○	943 0150 060 03	1.5	0.75	3		10	60	3	○
A60 0150 075 04					10	75	4	●	943 0150 075 04					10	75	4	○
A60 0200 060 03	2	1	4		14	60	3	○	943 0200 060 03	2	1	4		14	60	3	○
A60 0200 075 04					14	75	4	●	943 0200 075 04					14	75	4	○
A60 0250 060 03	2.5	1.25	4		18	60	3	○	943 0250 060 03	2.5	1.25	4		18	60	3	●
A60 0250 075 04					18	75	4	○	943 0250 075 04					18	75	4	○
A60 0300	3	1.5	5		21	60	3	○	943 0300	3	1.5	5		21	60	3	○
A60 0300 075 06					21	75	6	○	943 0300 075 06					21	75	6	●
A60 0400	4	2	8		28	60	4	●	943 0400	4	2	8		28	60	4	○
A60 0400 075 06					28	75	6	●	943 0400 075 06					28	75	6	●
A60 0500 *	5	2.5	9		32	60	5	●	943 0500 *	5	2.5	9		32	60	5	○
A60 0500 075 06					32	75	6	○	943 0500 075 06					32	75	6	●
A60 0600	6	3	10		40	75	6	●	943 0600	6	3	10		40	75	6	●
A60 0600 075 06					40	75	6	●	943 0600 075 06					40	75	6	●
A60 0800	8	4	12		40	75	8	●	943 0800	8	4	12		40	75	8	●
A60 0800 075 06					40	75	8	○	943 0800 075 06					40	75	8	○
A60 1000 075	10	5	14		40	75	10	○	943 1000 075	10	5	14		40	75	10	○
A60 1000 100 *					60	100	10	●	943 1000 100 *					60	100	10	●
A60 1200	12	6	16		60	100	12	●	943 1200	12	6	16		60	100	12	●
A60 1200 075 06					60	100	12	○	943 1200 075 06					60	100	12	○
A60 1400 *	14	7	32		80	125	14	○	943 1400 *	14	7	32		80	125	14	○
A60 1400 075 06					80	125	14	○	943 1400 075 06					80	125	14	○
A60 1600	16	8	38		80	125	16	○	943 1600	16	8	38		80	125	16	○
A60 1600 075 06					80	125	16	○	943 1600 075 06					80	125	16	○
A60 1800	18	9	38		80	125	18	○	943 1800	18	9	38		80	125	18	○
A60 1800 075 06					80	125	18	○	943 1800 075 06					80	125	18	○
A60 2000	20	10			80	125	20	○	943 2000	20	10			80	125	20	●
A60 2000 075 06					80	125	20	○	943 2000 075 06					80	125	20	○

* - DIN 6535

Material Group | Material-Gruppe | Groupe Matière | Gruppo Materiali | 材质主类

Cutting Parameter

N01	N02	N03	K01	K02	P01	P02	P03	M01	M02	S01	S02	S03	H01	H02	O01	O02	388
-----	-----	-----	-----	-----	-----	-----	-----	-----	-----	-----	-----	-----	-----	-----	-----	-----	-----

944 / 945 / A61 / A62



BN 45 EXTRA-LONG BALLNOSE CUTTERS / WITH RECESS, 2 FLUTES

- VHM BN 45 Radiuschaftfräser, extra-lang, 2 Zähne
- Frese sferiche extra-lunghe BN 45, 2 taglienti
- Fraises BN 45 extra-longues, à bout hémisphérique, 2 dents
- 整体硬质合金 BN 45 系列 2刃加长型球头铣刀

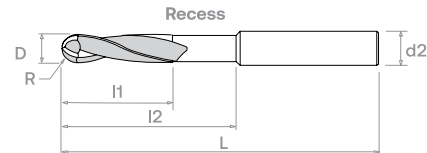
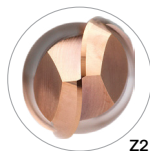
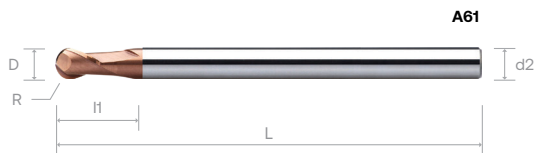

Order Number	Dimension (mm)						B0909	Order Number	Dimension (mm)						B0819
	D	R	I1	I2	L	d2 (h6)			D	R	I1	I2	L	d2 (h6)	
A61 0100 100 03	1	0.5	3		100	3	°	944 0100 100 03	1	0.5	3		100	3	°
A61 0100 100 04					100	4	°	944 0100 100 04					100	4	°
A61 0150 100 03	1.5	0.75	3		100	3	°	944 0150 100 03	1.5	0.75	3		100	3	°
A61 0150 100 04					100	4	°	944 0150 100 04					100	4	°
A61 0200 100 03	2	1	4		100	3	°	944 0200 100 03	2	1	4		100	3	°
A61 0200 100 04					100	4	°	944 0200 100 04					100	4	°
A61 0250 100 03	2.5	1.25	4		100	3	°	944 0250 100 03	2.5	1.25	4		100	3	°
A61 0250 100 04					100	4	°	944 0250 100 04					100	4	°
A61 0300	3	1.5	5		100	3	•	944 0300	3	1.5	5		100	3	•
A61 0300 100 06					100	6	•	944 0300 100 06					100	6	•
A61 0400	4	2	8		100	4	•	944 0400	4	2	8		100	4	•
A61 0400 100 06					100	6	•	944 0400 100 06					100	6	•
A61 0500	5	2.5	9		100	5	•	944 0500	5	2.5	9		100	5	•
A61 0500 100 06					100	6	•	944 0500 100 06					100	6	•
A61 0600 100	6	3	10		100	6	•	944 0600 100	6	3	10		100	6	•
A61 0600 150					150	6	•	944 0600 150					150	6	•
A61 0800 100	8	4	12		100	8	•	944 0800 100	8	4	12		100	8	•
A61 0800 150					150	8	•	944 0800 150					150	8	•
A61 1000 125	10	5	14		125	10	•	944 1000 125	10	5	14		125	10	•
A61 1000 150					150	10	•	944 1000 150					150	10	•
A61 1200 125	12	6	16		125	12	•	944 1200 125	12	6	16		125	12	°
A61 1200 150					150	12	•	944 1200 150					150	12	°
A61 1400 150	14	7	32		150	14	•	944 1400 150	14	7	32		150	14	°
A61 1400 200					200	14	•	944 1400 200					200	14	°
A61 1600 150	16	8	32		150	16	•	944 1600 150	16	8	32		150	16	°
A61 1600 200					200	16	•	944 1600 200					200	16	°
A61 1800 150	18	9	38		150	18	°	944 1800 150	18	9	38		150	18	°
A61 1800 200					200	18	°	944 1800 200					200	18	°
A61 2000 150	20	10	38		150	20	°	944 2000 150	20	10	38		150	20	°
A61 2000 200					200	20	•	944 2000 200					200	20	°

cont'd ▶

Material Group | Material-Gruppe | Groupe Matière | Gruppo Materiali | 材质主类

Cutting Parameter



389

BN 30
BN 45
BN 60
BN 60X
DM70 -
BN 70
BN GR

944 / 945 / A61 / A62



BN 45 EXTRA-LONG BALLNOSE CUTTERS / WITH RECESS, 2 FLUTES

- VHM BN 45 Radiuschaftfräser, extra-lang, 2 Zähne
- Frese sferiche extra-lunghe BN 45, 2 taglienti
- Fraises BN 45 extra-longues, à bout hémisphérique, 2 dents
- 整体硬质合金 BN 45 系列 2刃加长型球头铣刀

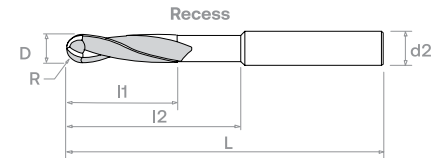
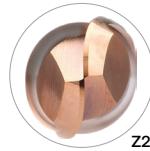
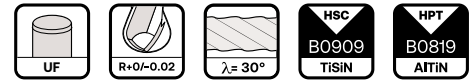

Order Number	Dimension (mm)						B0909	Order Number	Dimension (mm)						B0819
	D	R	I1	I2	L	d2 (h6)			D	R	I1	I2	L	d2 (h6)	
A62 0100 100 03	1	0.5	3	10	100	3	°	945 0100 100 03	1	0.5	3	10	100	3	°
A62 0100 100 04				10	100	4	°	945 0100 100 04				10	100	4	°
A62 0150 100 03	1.5	0.75	3	15	100	3	°	945 0150 100 03	1.5	0.75	3	15	100	3	°
A62 0150 100 04				15	100	4	°	945 0150 100 04				15	100	4	°
A62 0200 100 03	2	1	4	20	100	3	•	945 0200 100 03	2	1	4	20	100	3	°
A62 0200 100 04				20	100	4	•	945 0200 100 04				20	100	4	•
A62 0250 100 03	2.5	1.25	4	25	100	3	°	945 0250 100 03	2.5	1.25	4	25	100	3	°
A62 0250 100 04				25	100	4	°	945 0250 100 04				25	100	4	°
A62 0300	3	1.5	5	30	100	3	°	945 0300	3	1.5	5	30	100	3	°
A62 0300 100 06				30	100	6	•	945 0300 100 06				30	100	6	•
A62 0400	4	2	8	40	100	4	°	945 0400	4	2	8	40	100	4	°
A62 0400 100 06				40	100	6	°	945 0400 100 06				40	100	6	•
A62 0500	5	2.5	9	50	100	5	•	945 0500	5	2.5	9	50	100	5	°
A62 0500 100 06				50	100	6	°	945 0500 100 06				50	100	6	•
A62 0600 100	6	3	10	60	100	6	•	945 0600 100	6	3	10	60	100	6	°
A62 0600 150				60	150	6	°	945 0600 150				60	150	6	•
A62 0800 100	8	4	12	60	100	8	•	945 0800 100	8	4	12	60	100	8	°
A62 0800 150				80	150	8	°	945 0800 150				80	150	8	•
A62 1000 125 *	10	5	14	85	125	10	°	945 1000 125 *	10	5	14	85	125	10	°
A62 1000 150				100	150	10	°	945 1000 150				100	150	10	•
A62 1200 125	12	6	16	85	125	12	•	945 1200 125	12	6	16	85	125	12	°
A62 1200 150				110	150	12	°	945 1200 150				110	150	12	°
A62 1400 150	14	7	32	110	150	14	•	945 1400 150	14	7	32	110	150	14	°
A62 1400 200				150	200	14	°	945 1400 200				150	200	14	°
A62 1600 150	16	8	32	110	150	16	°	945 1600 150	16	8	32	110	150	16	°
A62 1600 200 *				150	200	16	°	945 1600 200 *				150	200	16	•
A62 1800 150	18	9	38	110	150	18	°	945 1800 150	18	9	38	110	150	18	°
A62 1800 200 *				150	200	18	°	945 1800 200 *				150	200	18	°
A62 2000 150	20	10	38	110	150	20	°	945 2000 150	20	10	38	110	150	20	°
A62 2000 200 *				150	200	20	°	945 2000 200 *				150	200	20	•

* - DIN 6535

Material Group | Material-Gruppe | Groupe Matière | Gruppo Materiali | 材质主类

Cutting Parameter

N01	N02	N03	K01	K02	P01	P02	P03	M01	M02	S01	S02	S03	H01	H02	O01	O02	389
			○	●	○	○	●	○	●	○	●	○	●	○			

BN 45 MINIATURE BALLNOSE CUTTERS, 2 FLUTES

- VHM BN45 Radiuskleinstschafffräser, 2 Zähne
- Micro-frese sferiche BN 45, 2 taglienti
- Micro-fraises BN 45 à bout hémisphérique, 2 dents
- 整体硬质合金 BN 45 系列 微小径2刃球头铣刀

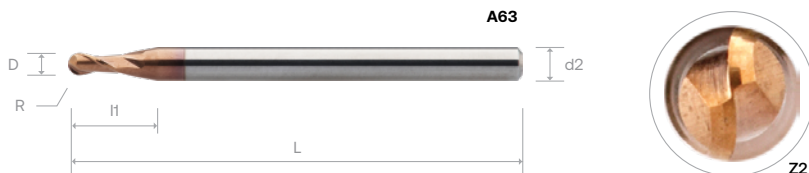
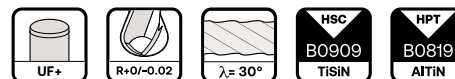

Order Number	Dimension (mm)						B0819	Order Number	Dimension (mm)						B0909
	D	R	l1	l2	L	d2 (h6)			D	R	l1	l2	L	d2 (h6)	
935 0020 03	0.2	0.1	0.4		40	3	•	A63 0100 100 03	0.2	0.1	0.4		40	3	◦
935 0020 04					40	4	•	A63 0100 100 04					40	4	◦
935 0030 03	0.3	0.15	0.6		40	3	•	A63 0150 100 03	0.3	0.15	0.6		40	3	◦
935 0030 04					40	4	•	A63 0150 100 04					40	4	•
935 0040 03	0.4	0.2	0.8		40	3	•	A63 0200 100 03	0.4	0.2	0.8		40	3	◦
935 0040 04					40	4	•	A63 0200 100 04					40	4	•
935 0050 03	0.5	0.25	1.2		40	3	•	A63 0250 100 03	0.5	0.25	1.2		40	3	◦
935 0050 04					40	4	•	A63 0250 100 04					40	4	•
935 0060 03	0.6	0.3	1.4		40	3	•	A63 0300	0.6	0.3	1.4		40	3	•
935 0060 04					40	4	•	A63 0300 100 06					40	4	•
935 0070 03	0.7	0.35	1.6		40	3	◦	A63 0400	0.7	0.35	1.6		40	3	◦
935 0070 04					40	4	•	A63 0400 100 06					40	4	◦
935 0080 03	0.8	0.4	1.8		40	3	•	A63 0500	0.8	0.4	1.8		40	3	◦
935 0080 04					40	4	•	A63 0500 100 06					40	4	•
935 0090 03	0.9	0.45	2		40	3	◦	A63 0600 100	0.9	0.45	2		40	3	◦
935 0090 04					40	4	•	A63 0600 150					40	4	•

BN 30
BN 45
BN 60
BN 60X
DM70 - BN70
BN GR

D mm	Tol. μm
0.1 ~ 0.7	0 / -12
0.7 ~ 4.0	0 / -20

Material Group | Material-Gruppe | Groupe Matière | Gruppo Materiali | 材质主类



Cutting Parameter

390

BN 45 MINIATURE BALLNOSE CUTTERS WITH LONG NECK SHANK 6, 2 FLUTES

- VHM BN 45 Kleinradiusfräser mit langem Hals, 2 Zähne
- Micro-frese sferiche BN 45, con collo lungo, codolo 6, 2 taglienti
- Micro-fraises BN 45 à bout hémisphérique avec cou long tige 6, 2 dents
- 整体硬质合金 BN 45 系列 微小径2刃长颈球头铣刀 Ø6柄



Order Number	Dimension (mm)							B0909
	D	R	l1	l2	L	d1	d2 (h6)	
A65 0050 060 0600 025	0.5	0.25	0.5	2.5	60	0.45	6	•
A65 0060 060 0600 060	0.6	0.3	0.6	6	60	0.55	6	•
A65 0080 060 0600 040	0.8	0.4	0.8	4	60	0.75	6	◦
A65 0080 060 0600 080				8	60	0.75	6	◦
A65 0100 060 0600 050	1.0	0.5	1.5	5	60	0.9	6	•
A65 0100 060 0600 080				8	60	0.9	6	◦
A65 0100 060 0600 120				12	60	0.9	6	◦
A65 0120 060 0600 060	1.2	0.6	1.8	6	60	1.1	6	•
A65 0150 060 0600 080	1.5	0.75	2.3	8	60	1.4	6	•
A65 0150 060 0600 120				12	60	1.4	6	•
A65 0150 060 0600 160				16	60	1.4	6	◦
A65 0160 060 0600 160	1.6	0.8	2.4	16	60	1.4	6	◦
A65 0180 060 0600 160	1.8	0.9	2.7	16	60	1.7	6	◦
A65 0200 060 0600 120	2.0	1	3	12	60	1.9	6	•
A65 0200 060 0600 160				16	60	1.9	6	◦
A65 0200 075 0600 200				20	75	1.9	6	◦
A65 0250 075 0600 125	2.5	1.25	3	12.5	75	2.4	6	•
A65 0300 075 0600 160	3.0	1.5	4.5	16	75	2.8	6	•
A65 0300 075 0600 200				20	75	2.8	6	◦
A65 0400 075 0600 200	4.0	2	6	20	75	3.7	6	•

Material Group | Material-Gruppe | Groupe Matière | Gruppo Materiali | 材质主类

Cutting Parameter

N01	N02	N03	K01	K02	P01	P02	P03	M01	M02	S01	S02	S03	H01	H02	O01	O02	392 - 395
			○	●	○	○	○	○	●	○	●	○	●	○			

BN 45 MINIATURE BALLNOSE CUTTERS WITH LONG NECK, 2 FLUTES

- VHM BN 45 Kleinstradiusfräser mit langem Hals, 2 Zähne
- Micro-frese sferiche BN 45, con collo lungo, 2 taglienti
- Micro-fraises BN 45 à bout hémisphérique avec cou long, 2 dents
- 整体硬质合金 BN 45 系列 微小径2刃长颈球头铣刀

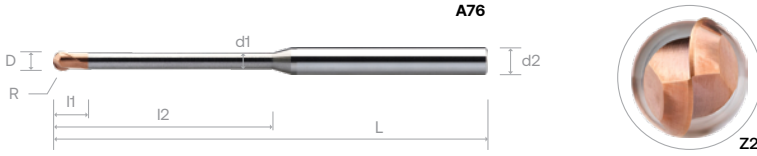
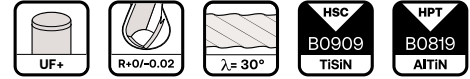

Order Number	Dimension (mm)							B0819	Order Number	Dimension (mm)							B0909									
	D	R	I1	I2	L	d1	d2 (h6)			D	R	I1	I2	L	d1	d2 (h6)										
937 0020 050 0400				-	50	-	4	◦	A76 0020 050 0400				-	50	-	4	•	A76 0020 050 0400				-	50	-	4	•
937 0020 050 0400 005	0.2	0.10	0.2	0.5	50	0.17	4	◦	A76 0020 050 0400 005	0.2	0.10	0.2	0.5	50	0.17	4	•	A76 0020 050 0400 005	0.2	0.10	0.2	0.5	50	0.17	4	•
937 0020 050 0400 010				1.0	50	0.17	4	•	A76 0020 050 0400 010				1.0	50	0.17	4	•	A76 0020 050 0400 010				1.0	50	0.17	4	•
937 0020 050 0400 015				1.5	50	0.17	4	•	A76 0020 050 0400 015				1.5	50	0.17	4	•	A76 0020 050 0400 015				1.5	50	0.17	4	•
937 0030 050 0400				-	50	-	4	◦	A76 0030 050 0400				-	50	-	4	•	A76 0030 050 0400				-	50	-	4	•
937 0030 050 0400 010	0.3	0.15	0.3	1.0	50	0.27	4	•	A76 0030 050 0400 010	0.3	0.15	0.3	1.0	50	0.27	4	•	A76 0030 050 0400 010	0.3	0.15	0.3	1.0	50	0.27	4	•
937 0030 050 0400 020				2.0	50	0.27	4	•	A76 0030 050 0400 020				2.0	50	0.27	4	•	A76 0030 050 0400 020				2.0	50	0.27	4	•
937 0030 050 0400 030				3.0	50	0.27	4	◦	A76 0030 050 0400 030				3.0	50	0.27	4	•	A76 0030 050 0400 030				3.0	50	0.27	4	•
937 0040 050 0400				-	50	-	4	◦	A76 0040 050 0400				-	50	-	4	•	A76 0040 050 0400				-	50	-	4	•
937 0040 050 0400 010	0.4	0.20		1.0	50	0.37	4	•	A76 0040 050 0400 010	0.4	0.20		1.0	50	0.37	4	•	A76 0040 050 0400 010	0.4	0.20		1.0	50	0.37	4	•
937 0040 050 0400 020				2.0	50	0.37	4	•	A76 0040 050 0400 020				2.0	50	0.37	4	•	A76 0040 050 0400 020				2.0	50	0.37	4	•
937 0040 050 0400 030				3.0	50	0.37	4	•	A76 0040 050 0400 030				3.0	50	0.37	4	•	A76 0040 050 0400 030				3.0	50	0.37	4	•
937 0040 050 0400 040				4.0	50	0.37	4	•	A76 0040 050 0400 040				4.0	50	0.37	4	•	A76 0040 050 0400 040				4.0	50	0.37	4	•
937 0040 050 0400 050				5.0	50	0.37	4	◦	A76 0040 050 0400 050				5.0	50	0.37	4	•	A76 0040 050 0400 050				5.0	50	0.37	4	•
937 0050 050 0400				-	50	-	4	◦	A76 0050 050 0400				-	50	-	4	•	A76 0050 050 0400				-	50	-	4	•
937 0050 050 0400 020	0.5	0.25		2.0	50	0.45	4	•	A76 0050 050 0400 020	0.5	0.25		2.0	50	0.45	4	•	A76 0050 050 0400 020	0.5	0.25		2.0	50	0.45	4	•
937 0050 050 0400 030				3.0	50	0.45	4	•	A76 0050 050 0400 030				3.0	50	0.45	4	•	A76 0050 050 0400 030				3.0	50	0.45	4	•
937 0050 050 0400 040				4.0	50	0.45	4	•	A76 0050 050 0400 040				4.0	50	0.45	4	•	A76 0050 050 0400 040				4.0	50	0.45	4	•
937 0050 050 0400 050				5.0	50	0.45	4	•	A76 0050 050 0400 050				5.0	50	0.45	4	•	A76 0050 050 0400 050				5.0	50	0.45	4	•
937 0050 050 0400 060				6.0	50	0.45	4	•	A76 0050 050 0400 060				6.0	50	0.45	4	•	A76 0050 050 0400 060				6.0	50	0.45	4	•
937 0050 050 0400 080				8.0	50	0.45	4	•	A76 0050 050 0400 080				8.0	50	0.45	4	•	A76 0050 050 0400 080				8.0	50	0.45	4	•
937 0060 050 0400 020	0.6	0.30		2.0	50	0.55	4	◦	A76 0060 050 0400 020	0.6	0.30		2.0	50	0.55	4	•	A76 0060 050 0400 020	0.6	0.30		2.0	50	0.55	4	•
937 0060 050 0400				-	50	-	4	◦	A76 0060 050 0400				-	50	-	4	•	A76 0060 050 0400				-	50	-	4	•
937 0060 050 0400 030				3.0	50	0.55	4	•	A76 0060 050 0400 030				3.0	50	0.55	4	•	A76 0060 050 0400 030				3.0	50	0.55	4	•
937 0060 050 0400 040				4.0	50	0.55	4	•	A76 0060 050 0400 040				4.0	50	0.55	4	•	A76 0060 050 0400 040				4.0	50	0.55	4	•
937 0060 050 0400 050				5.0	50	0.55	4	•	A76 0060 050 0400 050				5.0	50	0.55	4	•	A76 0060 050 0400 050				5.0	50	0.55	4	•
937 0060 050 0400 060				6.0	50	0.55	4	•	A76 0060 050 0400 060				6.0	50	0.55	4	•	A76 0060 050 0400 060				6.0	50	0.55	4	•
937 0060 050 0400 080				8.0	50	0.55	4	•	A76 0060 050 0400 080				8.0	50	0.55	4	•	A76 0060 050 0400 080				8.0	50	0.55	4	•
937 0080 050 0400				-	50	-	4	◦	A76 0080 050 0400				-	50	-	4	•	A76 0080 050 0400				-	50	-	4	•
937 0080 050 0400 020	0.8	0.40		2.0	50	0.75	4	•	A76 0080 050 0400 020	0.8	0.40		2.0	50	0.75	4	•	A76 0080 050 0400 020	0.8	0.40		2.0	50	0.75	4	•
937 0080 050 0400 040				4.0	50	0.75	4	◦	A76 0080 050 0400 040				4.0	50	0.75	4	•	A76 0080 050 0400 040				4.0	50	0.75	4	•
937 0080 050 0400 050				5.0	50	0.75	4	•	A76 0080 050 0400 050				5.0	50	0.75	4	•	A76 0080 050 0400 050				5.0	50	0.75	4	•
937 0080 050 0400 060				6.0	50	0.75	4	•	A76 0080 050 0400 060				6.0	50	0.75	4	•	A76 0080 050 0400 060				6.0	50	0.75	4	•
937 0080 050 0400 070				7.0	50	0.75	4	◦	A76 0080 050 0400 070				7.0	50	0.75	4	•	A76 0080 050 0400 070				7.0	50	0.75	4	•
937 0080 050 0400 080				8.0	50	0.75	4	•	A76 0080 050 0400 080				8.0	50	0.75	4	•	A76 0080 050 0400 080				8.0	50	0.75	4	•
937 0080 050 0400 100				10.0	50	0.75	4	•	A76 0080 050 0400 100				10.0	50	0.75	4	•	A76 0080 050 0400 100				10.0	50	0.75	4	•
937 0100 050 0400				-	50	-	4	◦	A76 0100 050 0400				-	50	-	4	•	A76 0100 050 0400				-	50	-	4	•
937 0100 050 0400 030	1.0	0.50		3.0	50	0.9	4	◦	A76 0100 050 0400 030	1.0	0.50		3.0	50	0.9	4	•	A76 0100 050 0400 030	1.0	0.50		3.0	50	0.9	4	•
937 0100 050 0400 040				4	50	0.9	4	•	A76 0100 050 0400 040				4	50	0.9	4	•	A76 0100 050 0400 040				4	50	0.9	4	•
937 0100 050 0400 050				5	50	0.9	4	•	A76 0100 050 0400 050				5	50	0.9	4	•	A76 0100 050 0400 050				5	50	0.9	4	•
937 0100 050 0400 060				6	50	0.9	4	•	A76 0100 050 0400 060				6	50	0.9	4	•	A76 0100 050 0400 060				6	50	0.9	4	•
937 0100 050 0400 070				7	50	0.9	4	◦	A76 0100 050 0400 070				7	50	0.9	4	•	A76 0100 050 0400 070				7	50	0.9	4	•
937 0100 050 0400 080				8	50	0.9	4	•	A76 0100 050 0400 080				8	50	0.9	4	•	A76 0100 050 0400 080				8	50	0.9	4	•
937 0100 050 0400 090				9	50	0.9	4	◦	A76 0100 050 0400 090				9	50	0.9	4	•	A76 0100 050 0400 090				9	50	0.9	4	•
937 0100 050 0400 100				10	50	0.9	4	•	A76 0100 050 0400 100				10	50	0.9	4	•	A76 0100 050 0400 100				10	50	0.9	4	•
937 0100 050 0400 120				12	50	0.9	4	•	A76 0100 050 0400 120				12	50	0.9	4	•	A76 0100 050 0400 120				12	50	0.9	4	•
937 0100 050 0400 140				14	50	0.9	4	•	A76 0100 050 0400 140				14	50	0.9	4	•	A76 0100 050 0400 140				14	50	0.9	4	•
937 0100 050 0400 160 *				16	50	0.9	4	•	A76 0100 050 0400 160 *				16	50	0.9	4	•	A76 0100 050 0400 160 *				16	50	0.9	4	•
937 0100 060 0400				-	60	-	4	◦	A76 0100 060 0400				-	60	-	4	•	A76 0100 060 0400				-	60	-	4	•
937 0100 060 0400 200				20	60	0.9	4	◦	A76 0100 060 0400 200				20	60	0.9	4	•	A76 0100 060 0400 200				20	60	0.9	4	•
937 0120 050 0400				-	50	-	4	◦	A76 0120 050 0400				-	50	-	4	•	A76 0120 050 0400				-	50	-	4	•
937 0120 050 0400 060	1.2	0.60		6	50	1.1	4	◦	A76 0120 050 0400 060	1.2	0.60		6	50	1.1	4	•	A76 0120 050 0400 060	1.2	0.60		6	50	1.1	4	•
937 0120 050 0400 080				8	50	1.1	4	◦	A76 0120 050 0400 080				8	50												

BN 45 MINIATURE BALLNOSE CUTTERS WITH LONG NECK, 2 FLUTES

- VHM BN 45 Kleinstradiusfräser mit langem Hals, 2 Zähne
- Micro-frese sferiche BN 45, con collo lungo, 2 taglianti
- Micro-fraises BN 45 à bout hémisphérique avec cou long, 2 dents
- 整体硬质合金 BN 45 系列 微小径2刃长颈球头铣刀

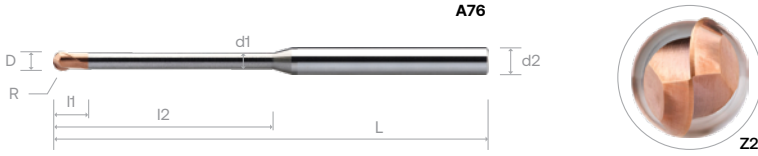

Order Number	Dimension (mm)							B0819	Order Number	Dimension (mm)							B0909
	D	R	I1	I2	L	d1	d2 (h6)			D	R	I1	I2	L	d1	d2 (h6)	
937 0150 050 0400	15	0.75	1.2	-	50	-	4	○	A76 0150 050 0400	15	0.75	1.2	-	50	-	4	●
937 0150 050 0400 080				8	50	1.4	4	●	A76 0150 050 0400 080				8	50	1.4	4	●
937 0150 050 0400 120				12	50	1.4	4	●	A76 0150 050 0400 120				12	50	1.4	4	●
937 0150 050 0400 160 *				16	50	1.4	4	○	A76 0150 050 0400 160 *				16	50	1.4	4	○
937 0150 060 0400	16	0.80	1.3	-	60	-	4	○	A76 0150 060 0400	16	0.80	1.3	-	60	-	4	●
937 0150 060 0400 180				18	60	1.4	4	●	A76 0150 060 0400 180				18	60	1.4	4	●
937 0160 050 0400				-	50	-	4	○	A76 0160 050 0400				-	50	-	4	○
937 0160 050 0400 080				8	50	1.5	4	○	A76 0160 050 0400 080				8	50	1.5	4	●
937 0160 050 0400 120	12	50	1.5	4	○	A76 0160 050 0400 120	12	50	1.5	4	●						
937 0160 050 0400 160 *	16	50	1.5	4	○	A76 0160 050 0400 160 *	16	50	1.5	4	●						
937 0160 060 0400	-	60	-	4	○	A76 0160 060 0400	-	60	-	4	○						
937 0160 060 0400 200	20	60	1.5	4	○	A76 0160 060 0400 200	20	60	1.5	4	●						
937 0180 050 0400	18	0.90	1.4	-	50	-	4	○	A76 0180 050 0400	18	0.90	1.4	-	50	-	4	○
937 0180 050 0400 080				8	50	1.7	4	○	A76 0180 050 0400 080				8	50	1.7	4	●
937 0180 050 0400 120				12	50	1.7	4	○	A76 0180 050 0400 120				12	50	1.7	4	●
937 0180 050 0400 160 *				16	50	1.7	4	●	A76 0180 050 0400 160 *				16	50	1.7	4	●
937 0180 060 0400	-	60	-	4	○	A76 0180 060 0400	-	60	-	4	○						
937 0180 060 0400 200	20	60	1.7	4	○	A76 0180 060 0400 200	20	60	1.7	4	○						
937 0200 050 0400	2	1	1.6	-	50	-	4	○	A76 0200 050 0400	2	1	1.6	-	50	-	4	●
937 0200 050 0400 040				4	50	1.9	4	○	A76 0200 050 0400 040				4	50	1.9	4	●
937 0200 050 0400 060				6	50	1.9	4	●	A76 0200 050 0400 060				6	50	1.9	4	●
937 0200 050 0400 080				8	50	1.9	4	●	A76 0200 050 0400 080				8	50	1.9	4	●
937 0200 050 0400 100	10	50	1.9	4	●	A76 0200 050 0400 100	10	50	1.9	4	●						
937 0200 050 0400 120	12	50	1.9	4	●	A76 0200 050 0400 120	12	50	1.9	4	●						
937 0200 050 0400 140	14	50	1.9	4	●	A76 0200 050 0400 140	14	50	1.9	4	●						
937 0200 050 0400 160	16	50	1.9	4	●	A76 0200 050 0400 160	16	50	1.9	4	●						
937 0200 060 0400	-	60	-	4	○	A76 0200 060 0400	-	60	-	4	○						
937 0200 060 0400 180	18	60	1.9	4	○	A76 0200 060 0400 180	18	60	1.9	4	●						
937 0200 060 0400 200	20	60	1.9	4	●	A76 0200 060 0400 200	20	60	1.9	4	●						
937 0200 060 0400 220	22	60	1.9	4	○	A76 0200 060 0400 220	22	60	1.9	4	●						
937 0200 075 0400	-	75	-	4	○	A76 0200 075 0400	-	75	-	4	○						
937 0200 075 0400 250	25	75	1.9	4	●	A76 0200 075 0400 250	25	75	1.9	4	●						
937 0200 075 0400 300	30	75	1.9	4	●	A76 0200 075 0400 300	30	75	1.9	4	●						
937 0300 050 0600	3	1.5	2.4	-	50	-	6	○	A76 0300 050 0600	3	1.5	2.4	-	50	-	6	○
937 0300 050 0600 080 *				8	50	2.8	6	●	A76 0300 050 0600 080 *				8	50	2.8	6	●
937 0300 050 0600 100				10	50	2.8	6	●	A76 0300 050 0600 100				10	50	2.8	6	●
937 0300 060 0600				-	60	-	6	○	A76 0300 060 0600				-	60	-	6	○
937 0300 060 0600 160	16	60	2.8	6	○	A76 0300 060 0600 160	16	60	2.8	6	●						
937 0300 060 0600 200	20	60	2.8	6	●	A76 0300 060 0600 200	20	60	2.8	6	●						
937 0300 075 0600	-	75	-	6	○	A76 0300 075 0600	-	75	-	6	○						
937 0300 075 0600 250	25	75	2.8	6	●	A76 0300 075 0600 250	25	75	2.8	6	●						
937 0300 075 0600 300	30	75	2.8	6	●	A76 0300 075 0600 300	30	75	2.8	6	●						
937 0300 075 0600 350	35	75	2.8	6	●	A76 0300 075 0600 350	35	75	2.8	6	●						
937 0400 050 0600	4	2	3.2	-	50	-	6	○	A76 0400 050 0600	4	2	3.2	-	50	-	6	○
937 0400 050 0600 100				10	50	3.7	6	○	A76 0400 050 0600 100				10	50	3.7	6	○
937 0400 060 0600				-	60	-	6	○	A76 0400 060 0600				-	60	-	6	○
937 0400 060 0600 160				16	60	3.7	6	○	A76 0400 060 0600 160				16	60	3.7	6	●
937 0400 060 0600 200	20	60	3.7	6	●	A76 0400 060 0600 200	20	60	3.7	6	●						
937 0400 075 0600	-	75	-	6	○	A76 0400 075 0600	-	75	-	6	○						
937 0400 075 0600 250	25	75	3.7	6	○	A76 0400 075 0600 250	25	75	3.7	6	●						
937 0400 075 0600 300	30	75	3.7	6	●	A76 0400 075 0600 300	30	75	3.7	6	●						
937 0400 075 0600 350	35	75	3.7	6	●	A76 0400 075 0600 350	35	75	3.7	6	●						
937 0400 100 0600	-	100	-	6	○	A76 0400 100 0600	-	100	-	6	○						
937 0400 100 0600 400	40	100	3.7	6	○	A76 0400 100 0600 400	40	100	3.7	6	●						
937 0400 100 0600 450	45	100	3.7	6	○	A76 0400 100 0600 450	45	100	3.7	6	●						
937 0400 100 0600 500	50	100	3.7	6	●	A76 0400 100 0600 500	50	100	3.7	6	●						

* - DIN 6535

Material Group | Material-Gruppe | Groupe Matière | Gruppo Materiali | 材质主类

Cutting Parameter

N01	N02	N03	K01	K02	P01	P02	P03	M01	M02	S01	S02	S03	H01	H02	O01	O02	392 - 395
○	○	○	●	●	○	○	○	○	○	○	○	○	○	○	○	○	

BN 45 TAPER NECK BALLNOSE CUTTERS, 2 FLUTES

- VHM BN 45 Radiuschaftfräser, lang, 2 Zähne
- Frese BN 45, con collo conico, 2 taglienti
- Fraises 2 tailles BN 45 col conique, 2 dents
- 整体硬质合金 BN 45 系列 2刃球头铣刀 锥颈型



Order Number	Dimension (mm)									Interference Angle	Effective Wall Gradient Angle			B0909		
	D	R	I1	I2	I3	d1	L	y	d2 (h6)		1°	2°	3°			
A78 0100 010 06 010	1.0	0.5	1.0	2.0	10	1.18	60	1°	6	11.85°	10.28	10.24	10.41	○		
A78 0100 015 06 010			1.0	2.0	15	1.35	60	1°	6	8.45°	15.08	15.33	15.59	○		
A78 0100 020 06 010			1.0	2.0	20	1.53	60	1°	6	6.56°	20.08	20.42	20.76	○		
A78 0100 025 06 010			1.0	2.0	25	1.70	60	1°	6	5.36°	25.08	25.51	25.94	○		
A78 0100 010 06 015			1.0	2.0	10	1.32	60	1.5°	6	11.92°	10.01	10.17	10.34	○		
A78 0100 015 06 015			1.0	2.0	15	1.58	60	1.5°	6	8.51°	-	15.21	15.47	○		
A78 0100 020 06 015			1.0	2.0	20	1.84	60	1.5°	6	6.61°	-	20.26	20.60	○		
A78 0100 025 06 015			1.0	2.0	25	2.10	60	1.5°	6	5.40°	-	25.30	25.73	○		
A78 0100 020 06 020			1.0	2.0	10	1.46	60	2°	6	11.99°	-	10.10	10.27	○		
A78 0100 015 06 020			1.0	2.0	15	1.81	60	2°	6	8.57°	-	15.10	15.35	○		
A78 0100 020 06 020			1.0	2.0	20	2.16	60	2°	6	6.66°	-	20.09	20.43	○		
A78 0100 010 06 030			1.0	2.0	10	1.74	60	3°	6	12.13	-	-	10.12	○		
A78 0100 015 06 030			1.0	2.0	15	2.26	60	3°	6	8.68°	-	-	15.11	○		
A78 0100 020 06 030			1.0	2.0	20	2.79	60	3°	6	6.75°	-	-	20.10	○		
A78 0100 015 06 050			1.0	2.0	15	3.17	60	5°	6	8.93°	-	-	-	○		
A78 0100 020 06 050			1.0	2.0	20	4.05	60	5°	6	6.96°	-	-	-	○		
A78 0150 010 06 010			1.5	0.75	1.5	3.0	10	1.64	60	1°	6	11.14°	10.09	10.25	10.42	○
A78 0150 015 06 010					1.5	3.0	15	1.82	60	1°	6	7.84°	15.09	15.34	15.59	○
A78 0150 020 06 010	1.5	3.0			20	1.99	60	1°	6	6.04°	20.09	20.43	20.77	○		
A78 0150 030 06 010	1.5	3.0			30	2.34	75	1°	6	4.14°	30.09	30.60	31.12	○		
A78 0150 010 06 020	1.5	3.0			10	1.89	60	2°	6	11.26°	-	10.13	10.29	○		
A78 0150 015 06 020	1.5	3.0			15	2.24	60	2°	6	7.94°	-	15.12	15.37	○		
A78 0150 020 06 020	1.5	3.0			20	2.59	60	2°	6	6.13°	-	20.12	20.45	○		
A78 0150 030 06 020	1.5	3.0			30	3.29	75	2°	6	4.20°	-	30.12	30.62	○		
A78 0150 015 06 030	1.5	3.0			15	2.66	60	3°	6	8.04°	-	-	15.15	○		
A78 0150 020 06 030	1.5	3.0			20	3.18	60	3°	6	6.22°	-	-	20.14	○		
A78 0150 030 06 030	1.5	3.0			30	4.23	75	3°	6	4.27°	-	-	30.12	○		
A78 0150 015 06 050	1.5	3.0			15	3.50	60	5°	6	8.26°	-	-	-	○		
A78 0150 020 06 050	1.5	3.0			20	4.38	75	5°	6	6.40°	-	-	-	○		
A78 0200 012 06 010	2.0	1.0			2.0	4.0	12	2.18	60	1°	6	8.81°	12.10	12.30	12.49	○
A78 0200 016 06 010					2.0	4.0	16	2.32	60	1°	6	6.77°	16.10	16.37	16.63	○
A78 0200 020 06 010					2.0	4.0	20	2.46	60	1°	6	5.50°	20.10	20.44	20.77	●
A78 0200 025 06 010					2.0	4.0	25	2.63	60	1°	6	4.45°	25.10	25.53	25.95	○
A78 0200 030 06 010					2.0	4.0	30	2.81	75	1°	6	3.74°	30.10	30.61	31.12	○
A78 0200 035 06 010			2.0	4.0	35	2.98	75	1°	6	3.22°	35.10	35.70	36.30	○		
A78 0200 040 06 010			2.0	4.0	40	3.61	75	1°	6	2.83°	45.10	40.79	41.47	●		
A78 0200 012 06 020			2.0	4.0	12	2.46	60	2°	6	8.90°	-	12.15	12.35	○		
A78 0200 016 06 020			2.0	4.0	16	2.74	60	2°	6	6.86°	-	16.15	16.41	○		

cont'd ▶

Material Group | Material-Gruppe | Groupe Matière | Gruppo Materiali | 材质主类

Cutting Parameter

N01	N02	N03	K01	K02	P01	P02	P03	M01	M02	S01	S02	S03	H01	H02	O01	O02	390 - 391
○	○	○	●	●	○	○	●	○	●	○	●	○	●	○	○	○	

BN 30
 BN 45
 BN 60
 BN 60X
 DM70 - BN70
 BN GR

BN 45 TAPER NECK BALLNOSE CUTTERS, 2 FLUTES

- VHM BN 45 Radiusschafffräser, lang, 2 Zähne
- Frese BN 45, con collo conico, 2 taglienti
- Fraises 2 tailles BN 45 col conique, 2 dents
- 整体硬质合金 BN 45 系列 2 刃球头铣刀 锥颈型

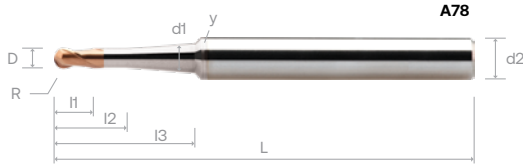

Order Number	Dimension (mm)									Interference Angle	Effective Wall Gradient Angle			B0909	
	D	R	l1	l2	l3	d1	L	y	d2 (h6)		1°	2°	3°		
A78 0200 020 06 020	2.0	1.0	2.0	4.0	20	3.02	60	2°	6	5.57°	-	20.15	20.48	○	
A78 0200 030 06 020			2.0	4.0	30	3.72	75	2°	6	3.80°	-	30.14	30.64	○	
A78 0200 040 06 020			2.0	4.0	40	4.41	75	2°	6	2.88°	-	40.14	40.81	○	
A78 0200 012 06 030			2.0	4.0	12	2.74	60	3°	6	9.00°	-	12.01	12.20	○	
A78 0200 016 06 030			2.0	4.0	16	3.16	60	3°	6	6.94°	-	-	16.19	○	
A78 0200 020 06 030			2.0	4.0	20	3.58	60	3°	6	5.65°	-	-	20.18	○	
A78 0200 030 06 030			2.0	4.0	30	4.63	75	3°	6	3.85°	-	-	30.16	○	
A78 0200 040 06 030			2.0	4.0	40	5.67	75	3°	6	2.92°	-	-	40.15	○	
A78 0200 020 06 050			2.0	4.0	20	4.70	60	5°	6	5.81°	-	-	-	○	
A78 0300 015 06 010			3.0	1.5	3.0	6.0	15	3.11	60	1°	6	5.73°	15.18	15.42	15.66
A78 0300 020 06 010	3.0	6.0			20	3.29	60	1°	6	4.32°	-	20.18	20.51	20.83	○
A78 0300 030 06 010	3.0	6.0			30	3.64	75	1°	6	2.89°	-	30.18	30.68	31.18	○
A78 0300 040 06 010	3.0	6.0			40	3.99	75	1°	6	2.17°	-	40.18	40.86	41.53	●
A78 0300 050 06 010	3.0	6.0			50	4.34	100	1°	6	1.74°	-	50.18	51.03	51.88	○
A78 0300 015 06 020	3.0	6.0			15	3.43	60	2°	6	5.79°	-	15.02	15.26	15.49	○
A78 0300 020 06 020	3.0	6.0			20	3.78	75	2°	6	4.37°	-	-	20.25	20.58	○
A78 0300 030 06 020	3.0	6.0			30	4.48	75	2°	6	2.93°	-	-	30.25	30.74	○
A78 0300 040 06 020	3.0	6.0			40	5.17	75	2°	6	2.21°	-	-	40.24	40.91	○
A78 0300 020 06 030	3.0	6.0			20	4.27	60	3°	6	4.43°	-	-	20.00	20.32	○
A78 0300 030 06 030	3.0	6.0	30	5.32	75	3°	6	2.98°	-	-	-	30.30	○		
A78 0300 050 06 030	3.0	6.0	50	7.41	100	3°	6	1.80°	-	-	-	50.26	○		
A78 0300 018 06 050	3.0	6.0	18	4.90	60	5°	6	5.03°	-	-	-	-	○		
A78 0400 020 06 010	4.0	2.0	4.0	8.0	20	4.12	60	1°	6	3.02°	20.26	20.58	20.90	○	
A78 0400 040 06 010			4.0	8.0	40	4.82	75	1°	6	1.48°	-	40.26	40.93	41.60	○
A78 0400 060 06 010	4.0	8.0	60	5.52	100	1°	6	0.98°	-	60.26	61.28	62.30	●		
A78 0500 030 06 010	5.0	2.5	5.0	10.0	30	5.30	75	1°	6	1.03°	30.34	30.82	31.31	○	
A78 0500 040 06 010			5.0	10.0	40	5.65	75	1°	6	0.76°	-	40.24	41.00	41.66	●
A78 0500 060 06 010	5.0	10.0	60	6.35	100	1°	6	0.50°	-	60.34	61.35	62.36	○		
A78 0600 030 08 010	6.0	3.0	6.0	12.0	30	6.13	100	1°	8	2.05°	30.41	30.89	31.37	○	
A78 0600 040 08 010			6.0	12.0	40	6.48	100	1°	8	1.52°	-	40.41	41.07	41.72	○
A78 0600 060 08 010			6.0	12.0	60	7.18	100	1°	8	1.00°	-	60.41	61.42	62.42	●
A78 0700 050 10 010	8.0	4.0	8.0	14.0	50	8.66	100	1°	10	1.23°	50.48	51.29	52.11	○	
A78 0800 060 10 010			8.0	14.0	60	9.01	100	1°	10	1.01°	-	60.48	61.47	62.46	○
A78 0800 070 10 010			8.0	14.0	70	9.35	100	1°	10	0.86°	-	70.48	71.64	72.81	○
A78 0800 080 10 010			8.0	14.0	80	9.70	100	1°	10	0.75°	-	80.48	81.82	83.16	○
A78 1000 060 12 010	10.0	5.0	10.0	18.0	60	10.67	100	1°	12	1.03°	60.64	61.61	62.58	○	
A78 1000 075 12 010			10.0	18.0	75	11.19	125	1°	12	0.81°	-	75.64	76.87	78.11	○

Material Group | Material-Gruppe | Groupe Matière | Gruppo Materiali | 材质主类

Cutting Parameter

N01	N02	N03	K01	K02	P01	P02	P03	M01	M02	S01	S02	S03	H01	H02	O01	O02	390 - 391
○	○	○	●	●	○	○	○	○	○	○	○	○	○	○	○	○	

Recommended Cutting Data



Note: These recommended cutting data indicators are just for reference. They should be adjusted according to the different cutting condition



BN 45 Ballnose Cutters, 2 Flutes - 929, 940, 941, C36, A57, A58, F38

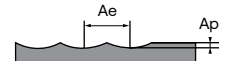

Roughing	K		P		M		S		H	
Working Material	Ductile Cast Iron		Prehardened steel		Stainless Steel		Nickel Alloy		Hardened steel	
Properties	-		35 ≤ HRC < 45		Low Machinability		-		45 ≤ HRC < 52	
Cutting depth, ap	0.10 × D		0.10 × D		0.08 × D		0.08 × D		0.10 × D	
Cutting Width, ae	0.30 × D		0.32 × D		0.080xD		0.24 × D		0.30 × D	
D	Vc	Fz	Vc	Fz	Vc	Fz	Vc	Fz	Vc	Fz
1	160	0.008	185	0.013	70	0.006	40	0.006	140	0.009
2		0.018		0.023		0.012		0.013		0.020
3		0.029		0.036		0.018		0.020		0.032
4		0.043		0.050		0.025		0.028		0.044
5		0.059		0.065		0.032		0.035		0.056
6		0.075		0.081		0.038		0.043		0.068
8		0.104		0.112		0.051		0.058		0.098
10		0.135		0.146		0.065		0.074		0.130
12		0.168		0.183		0.080		0.090		0.162
14		0.185		0.206		0.090		0.099		0.182
16		0.206		0.230		0.103		0.115		0.198
18		0.223		0.252		0.112		0.128		0.210
20		0.238		0.270		0.125		0.138		0.224
22	0.249	0.289	0.135	0.148	0.240					
25	0.264	0.305	0.146	0.168	0.252					

BN 45 Ballnose Cutters, 2 Flutes - 929, 940, 941, C36, A57, A58, F38

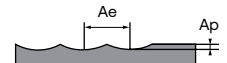

Finishing	K		P		M		S		H	
Working Material	Ductile Cast Iron		Prehardened steel		Stainless Steel		Nickel Alloy		Hardened steel	
Properties	-		35 ≤ HRC < 45		Low Machinability		-		45 ≤ HRC < 52	
Cutting depth, ap	0.05 × D		0.05 × D		0.05 × D		0.05 × D		0.05 × D	
Cutting Width, ae	0.02 × D		0.02 × D		0.02 × D		0.02 × D		0.02 × D	
D	Vc	Fz	Vc	Fz	Vc	Fz	Vc	Fz	Vc	Fz
1	170	0.006	195	0.011	80	0.004	50	0.004	150	0.006
2		0.015		0.019		0.008		0.008		0.016
3		0.024		0.029		0.013		0.013		0.026
4		0.034		0.041		0.018		0.018		0.035
5		0.045		0.054		0.022		0.025		0.045
6		0.056		0.068		0.028		0.030		0.054
8		0.078		0.094		0.037		0.042		0.078
10		0.105		0.124		0.046		0.052		0.104
12		0.134		0.154		0.058		0.064		0.130
14		0.148		0.173		0.065		0.072		0.146
16		0.162		0.193		0.072		0.082		0.158
18		0.176		0.211		0.082		0.090		0.168
20		0.186		0.225		0.089		0.095		0.179
22	0.197	0.238	0.092	0.105	0.192					
25	0.220	0.248	0.105	0.115	0.202					

BN 30
BN 45
BN 60
BN 60X
DM70 -
BN70
BN GR

Recommended Cutting Data



Note: These recommended cutting data indicators are just for reference. They should be adjusted according to the different cutting condition



BN 45 Ballnose Cutters, 4 Flutes - 485, B82

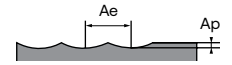

Roughing	K		P		M		S		H	
Working Material	Ductile Cast Iron		Prehardened steel		Stainless Steel		Nickel Alloy		Hardened steel	
Properties	-		35 ≤ HRC < 45		Low Machinability		-		45 ≤ HRC < 52	
Cutting depth, ap	0.10 × D		0.10 × D		0.08 × D		0.08 × D		0.10 × D	
Cutting Width, ae	0.30 × D		0.32 × D		0.24 × D		0.24 × D		0.30 × D	
D	Vc	Fz	Vc	Fz	Vc	Fz	Vc	Fz	Vc	Fz
3	160	0.016	185	0.021	70	0.013	40	0.015	140	0.017
4		0.022		0.029		0.018		0.021		0.024
5		0.032		0.037		0.023		0.027		0.031
6		0.041		0.046		0.028		0.033		0.038
8		0.057		0.063		0.038		0.044		0.056
10		0.073		0.081		0.048		0.056		0.073
12		0.091		0.102		0.058		0.068		0.091
14		0.101		0.115		0.066		0.078		0.103
16		0.112		0.129		0.076		0.088		0.113
18		0.121		0.142		0.084		0.099		0.121
20		0.129		0.153		0.093		0.108		0.130
22		0.136		0.163		0.101		0.117		0.140
25		0.145		0.174		0.113		0.135		0.149

BN 45 Ballnose Cutters, 4 Flutes - 485, B82

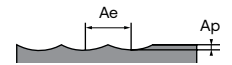

Finishing	K		P		M		S		H	
Working Material	Ductile Cast Iron		Prehardened steel		Stainless Steel		Nickel Alloy		Hardened steel	
Properties	-		35 ≤ HRC < 45		Low Machinability		-		45 ≤ HRC < 52	
Cutting depth, ap	0.05 × D		0.05 × D		0.05 × D		0.05 × D		0.05 × D	
Cutting Width, ae	0.02 × D		0.02 × D		0.02 × D		0.02 × D		0.02 × D	
D	Vc	Fz	Vc	Fz	Vc	Fz	Vc	Fz	Vc	Fz
3	170	0.015	195	0.017	80	0.011	50	0.011	150	0.015
4		0.021		0.024		0.015		0.016		0.021
5		0.028		0.031		0.018		0.020		0.026
6		0.034		0.039		0.022		0.024		0.032
8		0.047		0.053		0.030		0.034		0.046
10		0.063		0.070		0.037		0.042		0.060
12		0.079		0.087		0.046		0.053		0.075
14		0.089		0.098		0.052		0.059		0.084
16		0.098		0.110		0.059		0.068		0.092
18		0.106		0.120		0.067		0.076		0.099
20		0.113		0.129		0.072		0.081		0.106
22		0.121		0.137		0.078		0.089		0.114
25		0.136		0.145		0.088		0.098		0.122

Recommended Cutting Data



Note: These recommended cutting data indicators are just for reference. They should be adjusted according to the different cutting condition



BN 45 Long Ballnose Cutters, 2 Flutes - 931, 942, 943, A59, A60

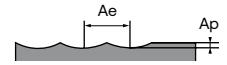

Roughing	K		P		M		S		H	
Working Material	Ductile Cast Iron		Prehardened steel		Stainless Steel		Nickel Alloy		Hardened steel	
Properties	-		35 ≤ HRC < 45		Low Machinability		-		45 ≤ HRC < 52	
Cutting depth, ap	0.10 × D		0.10 × D		0.08 × D		0.08 × D		0.10 × D	
Cutting Width, ae	0.30 × D		0.32 × D		0.24 × D		0.24 × D		0.30 × D	
D	Vc	Fz	Vc	Fz	Vc	Fz	Vc	Fz	Vc	Fz
1	125	0.007	165	0.011	65	0.006	35	0.007	120	0.009
2		0.016		0.021		0.012		0.014		0.020
3		0.026		0.033		0.018		0.022		0.032
4		0.040		0.047		0.024		0.030		0.044
5		0.056		0.061		0.030		0.038		0.054
6		0.072		0.077		0.038		0.046		0.068
8		0.101		0.107		0.050		0.061		0.092
10		0.132		0.140		0.063		0.076		0.122
12		0.166		0.183		0.078		0.097		0.150
14		0.181		0.206		0.088		0.106		0.170
16		0.191		0.220		0.100		0.121		0.188
18		0.203		0.240		0.113		0.137		0.204
20	0.214	0.247	0.120	0.152	0.220					

BN 45 Long Ballnose Cutters, 2 Flutes - 931, 942, 943, A59, A60

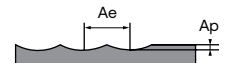

Finishing	K		P		M		S		H	
Working Material	Ductile Cast Iron		Prehardened steel		Stainless Steel		Nickel Alloy		Hardened steel	
Properties	-		35 ≤ HRC < 45		Low Machinability		-		45 ≤ HRC < 52	
Cutting depth, ap	0.05 × D		0.05 × D		0.05 × D		0.05 × D		0.05 × D	
Cutting Width, ae	0.02 × D		0.02 × D		0.02 × D		0.02 × D		0.02 × D	
D	Vc	Fz	Vc	Fz	Vc	Fz	Vc	Fz	Vc	Fz
1	135	0.005	175	0.009	75	0.003	45	0.003	140	0.006
2		0.014		0.017		0.007		0.007		0.013
3		0.022		0.026		0.011		0.012		0.020
4		0.032		0.037		0.015		0.017		0.030
5		0.043		0.049		0.019		0.023		0.040
6		0.054		0.062		0.024		0.027		0.051
8		0.076		0.087		0.032		0.039		0.072
10		0.103		0.117		0.040		0.049		0.095
12		0.134		0.145		0.050		0.063		0.118
14		0.147		0.162		0.056		0.068		0.132
16		0.160		0.179		0.063		0.078		0.148
18		0.172		0.195		0.071		0.088		0.162
20	0.179	0.206	0.075	0.090	0.172					

Recommended Cutting Data



Note: These recommended cutting data indicators are just for reference. They should be adjusted according to the different cutting condition



BN 45 Extra-Long Ballnose Cutters, 2 Flutes - 933, 944, 945, A61, A62

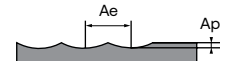

Roughing	K		P		M		S		H	
Working Material	Ductile Cast Iron		Prehardened steel		Stainless Steel		Nickel Alloy		Hardened steel	
Properties	-		35 ≤ HRC < 45		Low Machinability		-		45 ≤ HRC < 52	
Cutting depth, ap	0.10 × D		0.10 × D		0.08 × D		0.08 × D		0.10 × D	
Cutting Width, ae	0.30 × D		0.32 × D		0.24 × D		0.24 × D		0.30 × D	
D	Vc	Fz	Vc	Fz	Vc	Fz	Vc	Fz	Vc	Fz
1	105	0.004	145	0.009	60	0.005	30	0.007	100	0.008
2		0.010		0.020		0.012		0.014		0.018
3		0.016		0.032		0.017		0.020		0.029
4		0.026		0.045		0.023		0.029		0.040
5		0.037		0.059		0.029		0.037		0.049
6		0.049		0.075		0.036		0.044		0.061
8		0.070		0.104		0.048		0.058		0.083
10		0.092		0.137		0.060		0.073		0.110
12		0.117		0.182		0.075		0.094		0.135
14		0.126		0.205		0.084		0.101		0.153
16		0.130		0.216		0.096		0.117		0.169
18		0.136		0.233		0.107		0.130		0.184
20		0.141		0.238		0.115		0.146		0.198

BN 45 Extra-Long Ballnose Cutters, 2 Flutes - 933, 944, 945, A61, A62

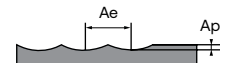

Finishing	K		P		M		S		H	
Working Material	Ductile Cast Iron		Prehardened steel		Stainless Steel		Nickel Alloy		Hardened steel	
Properties	-		35 ≤ HRC < 45		Low Machinability		-		45 ≤ HRC < 52	
Cutting depth, ap	0.05 × D		0.05 × D		0.05 × D		0.05 × D		0.05 × D	
Cutting Width, ae	0.02 × D		0.02 × D		0.02 × D		0.02 × D		0.02 × D	
D	Vc	Fz	Vc	Fz	Vc	Fz	Vc	Fz	Vc	Fz
1	115	0.003	155	0.007	70	0.003	40	0.002	120	0.005
2		0.009		0.015		0.006		0.003		0.012
3		0.015		0.023		0.010		0.005		0.018
4		0.022		0.034		0.013		0.008		0.027
5		0.030		0.046		0.017		0.011		0.036
6		0.038		0.058		0.022		0.013		0.046
8		0.054		0.082		0.029		0.020		0.065
10		0.075		0.111		0.036		0.025		0.086
12		0.098		0.140		0.046		0.032		0.106
14		0.106		0.154		0.050		0.034		0.119
16		0.115		0.170		0.057		0.039		0.133
18		0.122		0.184		0.065		0.044		0.146
20		0.126		0.192		0.067		0.045		0.155

Recommended Cutting Data



Note: These recommended cutting data indicators are just for reference. They should be adjusted according to the different cutting condition



BN 45 Miniature Ballnose Cutters, 2 Flutes - 935, A63

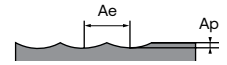

Profiling	N			P			M		
Working Material	Ductile Cast Iron			Prehardened steel			Stainless steel		
Properties	-			35 ≤ HRC < 45			Low Machinability		
D	Ap	N	Fz	Ap	N	Fz	Ap	N	Fz
0.2	0.000	45000	0.005		50000	0.005	0.010	37500	0.003
0.3	0.016	45000	0.005	0.018	50000	0.005	0.011	37500	0.007
0.4	0.029	45000	0.006	0.032	50000	0.006	0.011	37500	0.007
0.5	0.043	45000	0.007	0.048	50000	0.007	0.018	37500	0.009
0.6	0.049	39600	0.010	0.054	44000	0.010	0.033	37500	0.009
0.7	0.063	36450	0.012	0.070	40500	0.012	0.052	35630	0.010
0.8	0.074	33300	0.014	0.082	37000	0.014	0.062	32250	0.011
0.9	0.085	30600	0.016	0.094	34000	0.016	0.070	30750	0.012

BN 45 Miniature Ballnose Cutters, 2 Flutes - 935, A63

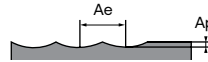

Profiling	S			H		
Working Material	Nickel Alloy			Hardened steel		
Properties	-			45 ≤ HRC < 52		
D	Ap	N	Fz	Ap	N	Fz
0.2	0.008	25000	0.003	0.013	50000	0.003
0.3	0.008	25000	0.005	0.014	50000	0.006
0.4	0.008	25000	0.005	0.014	50000	0.006
0.5	0.014	25000	0.007	0.023	50000	0.008
0.6	0.025	25000	0.007	0.041	50000	0.008
0.7	0.039	23750	0.008	0.065	47500	0.009
0.8	0.047	21500	0.009	0.078	43000	0.010
0.9	0.053	20500	0.010	0.088	41000	0.011

BN 45 Miniature Taper Neck Ballnose Cutters, 2 Flutes - A78

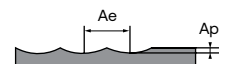

Profiling	K			P			M			
Working Material	Ductile Cast Iron			Prehardened steel			Stainless steel			
Properties	-			35 ≤ HRC < 45			Low Machinability			
D	Effective Length	Ap	N	Fz	Ap	N	Fz	Ap	N	Fz
1.0	20	0.045	27000	0.018	0.050	30000	0.018	0.038	20250	0.018
	40	0.027	24300	0.014	0.030	27000	0.014	0.022	18600	0.014
1.5	20	0.052	18720	0.027	0.058	20800	0.027	0.042	14180	0.026
	40	0.034	17370	0.023	0.038	19300	0.023	0.026	12980	0.022
2.0	20	0.072	14850	0.036	0.080	16500	0.036	0.052	10950	0.034
	40	0.045	13950	0.032	0.050	15500	0.032	0.031	10130	0.031
3.0	20	0.104	10620	0.052	0.115	11800	0.052	0.062	7580	0.051
	40	0.058	9450	0.042	0.064	10500	0.042	0.042	7200	0.044
4.0	45	0.052	9000	0.040	0.058	10000	0.040	0.034	6900	0.039
	20	0.135	8190	0.068	0.150	9100	0.068	0.068	6470	0.061
	40	0.072	7740	0.054	0.080	8600	0.054	0.052	5820	0.055
5.0	60	0.050	7038	0.043	0.056	7820	0.043	0.048	5180	0.044
	40	0.074	6660	0.065	0.082	7400	0.065	0.060	4760	0.068
	20	0.153	5580	0.102	0.170	6200	0.102	0.080	4350	0.091
6.0	40	0.135	5310	0.083	0.150	5900	0.083	0.064	3980	0.083
	60	0.126	5040	0.068	0.140	5600	0.068	0.056	3600	0.065
	80	0.108	4680	0.058	0.120	5200	0.058	0.040	3000	0.055

cont'd ▶

BN 30
BN 45
BN 60
BN 60X
DM70 -
BN 70
BN GR

Recommended Cutting Data



Note: These recommended cutting data indicators are just for reference. They should be adjusted according to the different cutting condition



BN 45 Miniature Taper Neck Ballnose Cutters, 2 Flutes - A78

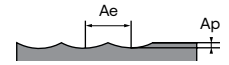

Profiling		K			P			M		
Working Material		Ductile Cast Iron			Prehardened steel			Stainless steel		
Properties		-			35 ≤ HRC < 45			Low Machinability		
D	Effective Length	Ap	N	Fz	Ap	N	Fz	Ap	N	Fz
8.0	25	0.162	4239	0.135	0.180	4710	0.135	0.096	3270	0.123
	60	0.135	3870	0.100	0.150	4300	0.100	0.064	2780	0.086
	75	0.117	3600	0.076	0.130	4000	0.076	0.048	2400	0.072
	105	0.090	3420	0.062	0.100	3800	0.062	0.032	1880	0.068
10.0	30	0.167	3465	0.168	0.185	3850	0.168	0.104	2700	0.151
	70	0.126	2970	0.120	0.140	3300	0.120	0.064	2030	0.123
	75	0.122	2925	0.110	0.135	3250	0.110	0.056	1950	0.094
12.0	35	0.180	2970	0.205	0.200	3300	0.205	0.112	2330	0.180
	70	0.135	2565	0.155	0.150	2850	0.155	0.080	1800	0.145
	90	0.108	2340	0.132	0.120	2600	0.132	0.056	1390	0.143

BN 45 Miniature Taper Neck Ballnose Cutters, 2 Flutes - A78

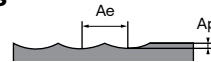

Profiling		S			H		
Working Material		Nickel Alloy			Hardened steel		
Properties		-			45 ≤ HRC < 52		
D	Effective Length	Ap	N	Fz	Ap	N	Fz
1.0	20	0.029	13500	0.014	0.048	27000	0.016
	40	0.017	12400	0.012	0.028	24800	0.013
1.5	20	0.031	9450	0.022	0.052	18900	0.024
	40	0.019	8650	0.018	0.032	17300	0.020
2.0	20	0.039	7300	0.028	0.065	14600	0.031
	40	0.023	6750	0.025	0.039	13500	0.028
3.0	20	0.047	5050	0.041	0.078	10100	0.046
	40	0.031	4800	0.036	0.052	9600	0.040
	45	0.025	4600	0.032	0.042	9200	0.035
4.0	20	0.051	4320	0.050	0.085	8630	0.055
	40	0.039	3880	0.045	0.065	7760	0.050
	60	0.036	3450	0.036	0.060	6900	0.040
5.0	40	0.045	3180	0.056	0.075	6350	0.062
	20	0.060	2900	0.075	0.100	5800	0.083
6.0	40	0.048	2650	0.068	0.080	5300	0.075
	60	0.042	2400	0.053	0.070	4800	0.059
	80	0.030	2000	0.045	0.050	4000	0.050
	25	0.072	2180	0.101	0.120	4360	0.112
8.0	60	0.048	1850	0.070	0.080	3700	0.078
	75	0.036	1600	0.059	0.060	3200	0.065
	105	0.024	1250	0.056	0.040	2500	0.062
10.0	30	0.078	1800	0.123	0.130	3600	0.137
	70	0.048	1350	0.101	0.080	2700	0.112
	75	0.042	1300	0.077	0.070	2600	0.085
12.0	35	0.084	1550	0.148	0.140	3100	0.164
	70	0.060	1200	0.119	0.100	2400	0.132
	90	0.042	930	0.117	0.070	1850	0.130

Recommended Cutting Data



Note: These recommended cutting data indicators are just for reference. They should be adjusted according to the different cutting condition



BN 45 Miniature Long Neck Ballnose Cutters, 2 Flutes - 937, A65, A76

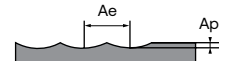

Profiling		K			P			M		
Working Material		Ductile Cast Iron			Prehardened steel			Stainless steel		
Properties		-			35 ≤ HRC < 45			Low Machinability		
D	Effective Length	Ap	N	Fz	Ap	N	Fz	Ap	N	Fz
0.2	0.5	0.000	45000	0.005		50000	0.005	0.010	34130	0.003
	1.0	0.009	45000	0.004	0.010	50000	0.004	0.007	34130	0.003
	1.5	0.007	45000	0.003	0.008	50000	0.003	0.004	30380	0.004
0.3	1.0	0.016	45000	0.005	0.018	50000	0.005	0.011	33750	0.005
	2.0	0.011	45000	0.004	0.012	50000	0.004	0.006	30380	0.004
	3.0	0.007	45000	0.003	0.008	50000	0.003	0.004	30380	0.004
0.4	1.0	0.029	45000	0.006	0.032	50000	0.006	0.016	27000	0.006
	2.0	0.020	45000	0.008	0.022	50000	0.008	0.015	27000	0.006
	3.0	0.008	45000	0.007	0.009	50000	0.007	0.008	24300	0.005
	4.0	0.004	45000	0.007	0.004	50000	0.007	0.005	24300	0.005
	5.0	0.002	45000	0.006	0.002	50000	0.006	0.004	21600	0.004
0.5	2.0	0.043	45000	0.009	0.048	50000	0.009	0.018	22500	0.010
	3.0	0.037	45000	0.008	0.041	50000	0.008	0.016	20250	0.009
	4.0	0.031	45000	0.008	0.034	50000	0.008	0.021	20250	0.009
	5.0	0.024	45000	0.007	0.027	50000	0.007	0.009	20250	0.007
	6.0	0.014	45000	0.007	0.016	50000	0.007	0.007	18000	0.009
	8.0	0.007	45000	0.006	0.008	50000	0.006	0.004	18000	0.009
0.6	2.0	0.049	39600	0.010	0.054	44000	0.010	0.022	22500	0.013
	3.0	0.042	39600	0.010	0.047	44000	0.010	0.018	22500	0.013
	4.0	0.036	38700	0.009	0.040	43000	0.009	0.012	20250	0.013
	5.0	0.030	37980	0.009	0.033	42200	0.009	0.010	20250	0.012
	6.0	0.022	37980	0.009	0.024	42200	0.009	0.008	18000	0.012
	8.0	0.011	37890	0.008	0.012	42100	0.008	0.008	18000	0.012
0.8	2.0	0.055	33300	0.014	0.061	37000	0.014	0.042	22500	0.017
	4.0	0.040	33300	0.014	0.045	37000	0.014	0.029	22500	0.017
	5.0	0.032	32400	0.013	0.036	36000	0.013	0.023	20250	0.015
	6.0	0.023	32400	0.013	0.026	36000	0.013	0.017	20250	0.015
	7.0	0.018	29700	0.013	0.020	33000	0.013	0.013	18000	0.016
	8.0	0.014	29700	0.013	0.016	33000	0.013	0.010	18000	0.015
	10.0	0.014	29700	0.012	0.016	33000	0.012	0.010	18000	0.014
1.0	3.0	0.050	27720	0.018	0.056	30800	0.018	0.052	20250	0.021
	4.0	0.049	27540	0.018	0.054	30600	0.018	0.036	20250	0.021
	5.0	0.047	27540	0.018	0.052	30600	0.018	0.034	20250	0.021
	6.0	0.045	27270	0.017	0.050	30300	0.017	0.032	18230	0.021
	7.0	0.043	26235	0.017	0.048	29150	0.017	0.030	18230	0.021
	8.0	0.041	26010	0.016	0.046	28900	0.016	0.027	18230	0.020
	9.0	0.036	25830	0.016	0.040	28700	0.016	0.024	18230	0.020
	10.0	0.032	25650	0.015	0.035	28500	0.015	0.021	18230	0.019
	12.0	0.023	25470	0.015	0.025	28300	0.015	0.013	17250	0.019
	14.0	0.020	25290	0.014	0.022	28100	0.014	0.010	16200	0.018
	16.0	0.017	24750	0.014	0.019	27500	0.014	0.008	16200	0.018
1.2	20.0	0.014	23850	0.014	0.015	26500	0.014	0.005	12150	0.018
	6.0	0.050	23400	0.021	0.056	26000	0.021	0.026	16200	0.024
	8.0	0.047	22950	0.020	0.052	25500	0.020	0.021	15900	0.023
	10.0	0.041	22500	0.019	0.045	25000	0.019	0.018	15830	0.022
1.4	12.0	0.034	22050	0.018	0.038	24500	0.018	0.016	15750	0.022
	8.0	0.056	20610	0.025	0.062	22900	0.025	0.029	14180	0.026
	12.0	0.038	19620	0.024	0.042	21800	0.024	0.018	14180	0.026
1.5	16.0	0.031	18900	0.023	0.034	21000	0.023	0.016	12600	0.025
	8.0	0.070	19800	0.027	0.078	22000	0.027	0.050	14180	0.027
	12.0	0.045	19080	0.026	0.050	21200	0.026	0.031	13880	0.027
	16.0	0.038	18360	0.026	0.042	20400	0.026	0.020	12600	0.025
	18.0	0.029	18000	0.026	0.032	20000	0.026	0.018	12600	0.025

cont'd ▶

BN 30
BN 45
BN 60
BN 60X
DM70 -
BN70
BN GR

Recommended Cutting Data



Note: These recommended cutting data indicators are just for reference. They should be adjusted according to the different cutting condition



BN 45 Miniature Long Neck Ballnose Cutters, 2 Flutes - 937, A65, A76

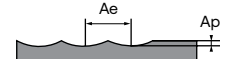

Profiling		K			P			M		
Working Material		Ductile Cast Iron			Prehardened steel			Stainless steel		
Properties		-			35 ≤ HRC < 45			Low Machinability		
D	Effective Length	Ap	N	Fz	Ap	N	Fz	Ap	N	Fz
1.6	8.0	0.079	19170	0.030	0.088	21300	0.030	0.057	14630	0.032
	12.0	0.054	18270	0.028	0.060	20300	0.028	0.042	13160	0.030
	16.0	0.045	17901	0.027	0.050	19890	0.027	0.034	13160	0.030
	20.0	0.036	17280	0.026	0.040	19200	0.026	0.026	11700	0.028
1.8	8.0	0.094	17550	0.035	0.104	19500	0.035	0.068	13200	0.036
	12.0	0.072	16740	0.032	0.080	18600	0.032	0.054	12750	0.033
	16.0	0.063	16380	0.031	0.070	18200	0.031	0.044	12300	0.033
	20.0	0.054	15912	0.030	0.060	17680	0.030	0.028	11850	0.031
2.0	4.0	0.144	16065	0.042	0.160	17850	0.042	0.104	12300	0.047
	6.0	0.144	15795	0.041	0.160	17550	0.041	0.104	12150	0.042
	8.0	0.101	15570	0.041	0.112	17300	0.041	0.073	12000	0.042
	10.0	0.101	15390	0.037	0.112	17100	0.037	0.073	11810	0.037
	12.0	0.095	15210	0.036	0.105	16900	0.036	0.067	11550	0.036
	14.0	0.095	15120	0.036	0.105	16800	0.036	0.067	11400	0.036
	16.0	0.086	15030	0.034	0.095	16700	0.034	0.062	11250	0.034
	18.0	0.086	14940	0.034	0.095	16600	0.034	0.042	11100	0.034
	20.0	0.072	14850	0.034	0.080	16500	0.034	0.042	10950	0.034
	22.0	0.068	14580	0.033	0.075	16200	0.033	0.026	10730	0.032
3.0	8.0	0.216	11340	0.062	0.240	12600	0.062	0.156	8250	0.069
	10.0	0.151	11205	0.058	0.168	12450	0.058	0.109	8100	0.069
	16.0	0.126	10980	0.056	0.140	12200	0.056	0.109	7800	0.062
	20.0	0.104	10620	0.052	0.115	11800	0.052	0.062	7580	0.062
	25.0	0.086	10260	0.050	0.095	11400	0.050	0.042	7350	0.062
	30.0	0.072	9900	0.046	0.080	11000	0.046	0.042	7200	0.062
	35.0	0.058	9450	0.042	0.064	10500	0.042	0.042	7200	0.059
4.0	10.0	0.288	8798	0.090	0.320	9775	0.090	0.208	6470	0.094
	16.0	0.202	8798	0.090	0.224	9775	0.090	0.146	6470	0.094
	20.0	0.202	8798	0.090	0.224	9775	0.090	0.146	6470	0.094
	25.0	0.115	7918	0.081	0.128	8798	0.081	0.083	5820	0.084
	30.0	0.115	7918	0.081	0.128	8798	0.081	0.083	5820	0.084
	35.0	0.072	7918	0.081	0.080	8798	0.081	0.052	5820	0.084
	40.0	0.072	7918	0.081	0.080	8798	0.081	0.052	5820	0.084
	45.0	0.058	7038	0.076	0.064	7820	0.076	0.052	5180	0.079
50.0	0.050	7038	0.076	0.056	7820	0.076	0.052	5180	0.079	

Recommended Cutting Data



Note: These recommended cutting data indicators are just for reference. They should be adjusted according to the different cutting condition



BN 45 Miniature Long Neck Ballnose Cutters, 2 Flutes - 937, A65, A76

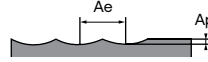

Profiling		S			H		
Working Material		Nickel Alloy			Hardened steel		
Properties		-			45 ≤ HRC < 52		
D	Effective Length	Ap	N	Fz	Ap	N	Fz
0.2	0.5	0.000	22750	0.003		45500	0.003
	1.0	0.005	22750	0.003	0.009	45500	0.003
	1.5	0.003	20250	0.003	0.005	40500	0.003
0.3	1.0	0.008	22500	0.004	0.014	45000	0.004
	2.0	0.005	20250	0.003	0.008	40500	0.004
	3.0	0.003	20250	0.003	0.005	40500	0.004
0.4	1.0	0.012	18000	0.005	0.020	36000	0.005
	2.0	0.011	18000	0.005	0.018	36000	0.005
	3.0	0.006	16200	0.004	0.010	32400	0.004
	4.0	0.004	16200	0.004	0.007	32400	0.004
	5.0	0.003	14400	0.004	0.005	28800	0.004
0.5	2.0	0.014	15000	0.008	0.023	30000	0.009
	3.0	0.012	13500	0.007	0.020	27000	0.008
	4.0	0.016	13500	0.007	0.026	27000	0.008
	5.0	0.007	13500	0.006	0.012	27000	0.007
	6.0	0.005	12000	0.007	0.008	24000	0.008
0.6	2.0	0.016	15000	0.011	0.027	30000	0.012
	3.0	0.013	15000	0.011	0.022	30000	0.012
	4.0	0.009	13500	0.010	0.016	27000	0.012
	5.0	0.008	13500	0.010	0.013	27000	0.011
	6.0	0.006	12000	0.010	0.010	24000	0.011
	8.0	0.006	12000	0.010	0.010	24000	0.011
0.8	2.0	0.031	15000	0.014	0.052	30000	0.015
	4.0	0.022	15000	0.014	0.036	30000	0.015
	5.0	0.018	13500	0.012	0.029	27000	0.014
	6.0	0.012	13500	0.012	0.021	27000	0.014
	7.0	0.010	12000	0.013	0.016	24000	0.014
	8.0	0.008	12000	0.012	0.013	24000	0.014
	10.0	0.008	12000	0.012	0.013	24000	0.013
1.0	3.0	0.039	13500	0.017	0.065	27000	0.019
	4.0	0.027	13500	0.017	0.046	27000	0.019
	5.0	0.026	13500	0.017	0.043	27000	0.019
	6.0	0.024	12150	0.017	0.040	24300	0.019
	7.0	0.022	12150	0.017	0.037	24300	0.019
	8.0	0.020	12150	0.016	0.034	24300	0.018
	9.0	0.018	12150	0.016	0.030	24300	0.018
	10.0	0.016	12150	0.015	0.026	24300	0.017
	12.0	0.010	11500	0.015	0.016	23000	0.017
	14.0	0.008	10800	0.014	0.013	21600	0.016
1.2	16.0	0.006	10800	0.014	0.010	21600	0.016
	20.0	0.004	8100	0.014	0.007	16200	0.016
	6.0	0.020	10800	0.020	0.033	21600	0.022
	8.0	0.016	10600	0.019	0.026	21200	0.021
1.4	10.0	0.014	10550	0.018	0.023	21100	0.020
	12.0	0.012	10500	0.018	0.020	21000	0.020
	8.0	0.021	9450	0.022	0.036	18900	0.024
	12.0	0.014	9450	0.021	0.023	18900	0.024
	16.0	0.012	8400	0.020	0.020	16800	0.022

cont'd ▶

BN 30

BN 45

BN 60

BN 60X

DM70 -
BN70

BN GR

Recommended Cutting Data



Note: These recommended cutting data indicators are just for reference. They should be adjusted according to the different cutting condition



BN 45 Miniature Long Neck Ballnose Cutters, 2 Flutes - 937, A65, A76

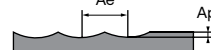

Profiling		S			H		
Working Material		Nickel Alloy			Hardened steel		
Properties		-			45 ≤ HRC < 52		
D	Effective Length	Ap	N	Fz	Ap	N	Fz
1.5	8.0	0.037	9450	0.022	0.062	18900	0.024
	12.0	0.023	9250	0.022	0.039	18500	0.024
	16.0	0.015	8400	0.021	0.025	16800	0.023
	18.0	0.013	8400	0.021	0.022	16800	0.023
1.6	8.0	0.043	9750	0.026	0.072	19500	0.029
	12.0	0.031	8780	0.024	0.052	17550	0.027
	16.0	0.025	8780	0.024	0.042	17550	0.027
	20.0	0.019	7800	0.023	0.032	15600	0.025
1.8	8.0	0.051	8800	0.030	0.085	17600	0.033
	12.0	0.041	8500	0.027	0.068	17000	0.030
	16.0	0.033	8200	0.027	0.055	16400	0.030
	20.0	0.021	7900	0.025	0.035	15800	0.028
2.0	4.0	0.078	8200	0.039	0.130	16400	0.043
	6.0	0.078	8100	0.034	0.130	16200	0.038
	8.0	0.055	8000	0.034	0.091	16000	0.038
	10.0	0.055	7880	0.031	0.091	15750	0.034
	12.0	0.050	7700	0.030	0.084	15400	0.033
	14.0	0.050	7600	0.030	0.084	15200	0.033
	16.0	0.047	7500	0.028	0.078	15000	0.031
	18.0	0.031	7400	0.028	0.052	14800	0.031
	20.0	0.031	7300	0.028	0.052	14600	0.031
	22.0	0.020	7150	0.026	0.033	14300	0.029
3.0	25.0	0.020	7000	0.026	0.033	14000	0.029
	30.0	0.012	6750	0.026	0.020	13500	0.028
	8.0	0.117	5500	0.057	0.195	11000	0.063
	10.0	0.082	5400	0.057	0.137	10800	0.063
	16.0	0.082	5200	0.051	0.137	10400	0.057
	20.0	0.047	5050	0.051	0.078	10100	0.057
	25.0	0.031	4900	0.051	0.052	9800	0.057
	30.0	0.031	4800	0.051	0.052	9600	0.057
4.0	35.0	0.031	4800	0.048	0.052	9600	0.054
	10.0	0.156	4320	0.077	0.260	8630	0.085
	16.0	0.109	4320	0.077	0.182	8630	0.085
	20.0	0.109	4320	0.077	0.182	8630	0.085
	25.0	0.062	3880	0.068	0.104	7760	0.076
	30.0	0.062	3880	0.068	0.104	7760	0.076
	35.0	0.039	3880	0.068	0.065	7760	0.076
	40.0	0.039	3880	0.068	0.065	7760	0.076
	45.0	0.039	3450	0.065	0.065	6900	0.072
50.0	0.039	3450	0.065	0.065	6900	0.072	



BALLNOSE

BN 60







For general machining

For material application between 53 HRC to 68 HRC

Index - BN 60, For 53 - 68 HRC

 Suitable for Material Groups
  Adapté pour les matériaux
  适用于材料
 Geeignet für die Materialgruppen
  Adatto per il materiale

H

EDP Number	Type	No. Z	Helix Angle	Coating	Performance	Page Number
A1L 	BN 60	4	30°	B0909	G	400
A71 	BN 60 Long	2	30°	B0909	G	401
A72 	BN 60 Long, Recess	2	30°	B0909	G	401
A73 	BN 60 Extra-Long	2	30°	B0909	G	402
A74 	BN 60 Extra-Long, Recess	2	30°	B0909	G	402
A75 	BN 60 Miniature	2	30°	B0909	G	403
A77 	BN 60 Taper Neck	2	30°	B0909	G	404

G - General P - Performance

FEATURES & BENEFITS

BN 60



Top View

1 Eccentric Grinding

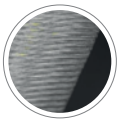

Optimum eccentric grinding in order to avoid rubbing, while maintaining maximum cutting tool strength.

2 Cutting Edge Preparation



- Enhances tool life
- Less material adhere on the cutting edge for stable machining
- Improves wear resistance and reduces excessive friction

3 Superior Coating to Reduce Friction

- Increases hardness and higher abrasive wear resistance
- Higher thermal resistance
- Smoother chips evacuation

4 Suitable for Material Group

H





1. Exzentrischer Schliff
Optimaler exzentrischer Schliff zur Reduzierung der Reibung unter Beibehaltung der maximalen Schneidstabilität
2. Schneidkantenbehandlung
Verbessert die Werkzeuglebensdauer
Weniger Materialanhaftungen an der Schneide Für stabile Bearbeitung
3. Ausgezeichnete Beschichtung zur Verringerung der Reibung
Erhöht die Härte und und bietet bessere Verschleißfestigkeit
Höhere Temperaturbeständigkeit
Glatte Oberfläche für besseren Spänefluß
4. Positiver Spanwinkel
Geeignet für die Materialgruppen H



1. 偏心研磨
最佳偏心研磨,可避免摩擦,同时保持最大切削刀具强度。
2. 切削刃设置提高刀具寿命
提高刀具寿命。
较少的材料粘在切削刃上。
用于稳定加工。
3. 优异的涂层,减少摩擦
增加硬度,提高材料耐磨性。
更高的抗热性。
更顺畅的排屑。
4. 正前角
适用于材料 H。



1. Levigatura orbitale
Levigatura orbitale ottimale per evitare sfregatura, garantendo la massima resistenza dello strumento di taglio.
2. Preparazione dell'angolo di taglio
Migliora la durata dello strumento
Meno materiale che aderisce sull'angolo di taglio
Per una lavorazione stabile
3. Rivestimento superiore per ridurre la frizione
Aumenta la durezza e una maggiore resistenza all'usura abrasiva
Resistenza termica superiore
Evacuazione dei trucioli più semplice
4. Angolo di taglio positivo
Adatto per il materiale H



1. Meulage excentrique
Meulage optimal diminuant le coefficient de friction tout en maintenant une bonne acuité de l'arête de coupe
2. Préparation des arêtes de coupes
Améliore la durée de vie de l'outil
Moins de matériau adhère à l'arête tranchante
Pour un usinage stable
3. Revêtement supérieur pour réduire la friction
Augmente la dureté et la résistance à l'abrasion
Résistance thermique supérieure
Évacuation des copeaux plus fluide
4. Angle de coupe positif
Adapté pour les matériaux H

BN 60 BALLNOSE CUTTERS, 4 FLUTES

- VHM BN 60 Standard Radiuschaftfräser, 4 Zähne
- Frese sferiche BN 60 Standard, 4 taglienti
- Fraises BN 60 Standard, à bout hémisphérique, 4 dents
- 整体硬质合金 BN 60 系列 球头 立铣刀 4 刃 - 标准长度



Order Number	Dimension (mm)						B0909
	D	R	I1	I2	L	d2 (h6)	
A1L 0300	3	1.5	5		40	3	°
A1L 0300 050 06			5		50	6	°
A1L 0400	4	2	8		50	4	°
A1L 0400 050 06			8		50	6	°
A1L 0500	5	2.5	9		50	5	°
A1L 0500 050 06			9		50	6	•
A1L 0600 050	6	3	10		50	6	•
A1L 0600 060			10		60	6	•
A1L 0800	8	4	12		64	8	°
A1L 1000	10	5	14		70	10	°
A1L 1200	12	6	16		75	12	•
A1L 1400	14	7	32		90	14	°
A1L 1600	16	8	32		90	16	°
A1L 1800	18	9	38		100	18	°
A1L 2000	20	10	38		100	20	°
A1L 2200	22	11	40		100	22	°
A1L 2500	25	12.5	40		100	25	°

BN 30
 BN 45
BN 60
 BN 60X
 DM70 -
 BN 70
 BN GR

Material Group | Material-Gruppe | Groupe Matière | Gruppo Materiali | 材质主类

Cutting Parameter

N01 N02 N03 K01 K02 P01 P02 P03 M01 M02 S01 S02 S03 H01 H02 O01 O02

405

BN 60 LONG BALLNOSE CUTTERS / WITH RECESS, 2 FLUTES

- VHM BN 60 Radiuschaftfräser, lang, 2 Zähne
- Frese sferiche lunghe BN 60 lunghe, 2 taglienti
- Fraises BN 60 longues, à bout hémisphérique, 2 dents
- 整体硬质合金BN60系列2刃长型球头铣刀

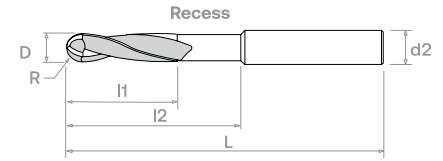
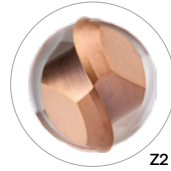

Order Number	Dimension (mm)						B0909	Order Number	Dimension (mm)						B0909
	D	R	l1	l2	L	d2 (h6)			D	R	l1	l2	L	d2 (h6)	
A71 0100 04	1	0.5	3		75	4	•	A72 0100 04	1	0.5	3	7	75	4	◦
A71 0100 075 06					75	6	•	A72 0100 075 06				7	75	6	•
A71 0150 04				15	0.75		75	4				•	A72 0150 04	15	0.75
A71 0150 075 06		75	6			•	A72 0150 075 06	10	75	6	•				
A71 0200 04	2	1	4				75	4	•	A72 0200 04	2	1	4		
A71 0200 075 06					75	6	•	A72 0200 075 06	14	75				6	•
A71 0250 04				2.5	1.25		75	4	•	A72 0250 04				2.5	1.25
A71 0250 075 06		75	6			•	A72 0250 075 06	18	75	6	•				
A71 0300	3	1.5	5				60	3	•	A72 0300	3	1.5	5		
A71 0300 075 06					75	6	•	A72 0300 075 06	21	75				6	•
A71 0400				4	2	8		60	4	•				A72 0400	4
A71 0400 075 06		75	6				•	A72 0400 075 06	28	75	6	•			
A71 0500	5	2.5	9					60	5	•	A72 0500	5	2.5	9	
A71 0500 075 06					75	6	•	A72 0500 075 06	32	75	6				•
A71 0600				6	3	10		75	6	•	A72 0600				6
A71 0800		75	8				•	A72 0800	40	75	8	•			
A71 1000 075	10	5	14					75	10	•	A72 1000 075	10	5	14	
A71 1000 100					100	10	•	A72 1000 100	60	100	10				•
A71 1200				12	6	16		100	12	•	A72 1200				12
A71 1400		125	14				•	A72 1400	80	125	14	◦			
A71 1600	16	8	32					125	16	•	A72 1600	16	8	32	
A71 1800					125	18	•	A72 1800	80	125	18				◦
A71 2000				20	10	38		125	20	•	A72 2000				20

Material Group | Material-Gruppe | Groupe Matière | Gruppo Materiali | 材质主类

Cutting Parameter

N01	N02	N03	K01	K02	P01	P02	P03	M01	M02	S01	S02	S03	H01	H02	O01	O02	406
-----	-----	-----	-----	-----	-----	-----	-----	-----	-----	-----	-----	-----	-----	-----	-----	-----	-----

BN 60 EXTRA-LONG BALLNOSE CUTTERS / WITH RECESS, 2 FLUTES

- VHM BN 60 Radiusschaffräser, extra-lang, 2 Zähne
- Frese sferiche extra-lunghe BN 60, 2 taglienti
- Fraises BN 60 extra-longues, à bout hémisphérique, 2 dents
- 整体硬质合金BN60系列2刃加长型球头铣刀

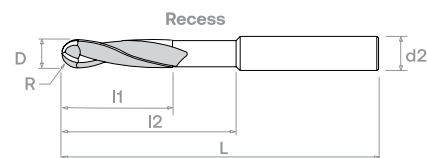
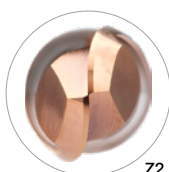
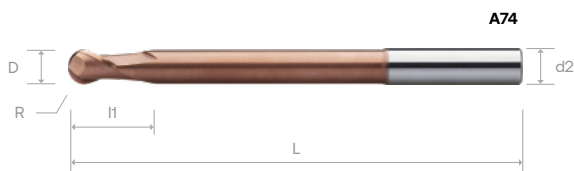

Order Number	Dimension (mm)						B0909	Order Number	Dimension (mm)						B0909
	D	R	I1	I2	L	d2 (h6)			D	R	I1	I2	L	d2 (h6)	
A73 0100 04	1	0.5	3		100	4	○	A74 0100 04	1	0.5	3	10	100	4	○
A73 0100 100 06					100	6	●	A74 0100 100 06					10	100	6
A73 0150 04	1.5	0.75	3		100	4	○	A74 0150 04	1.5	0.75	3	15	100	4	○
A73 0150 100 06					100	6	●	A74 0150 100 06					15	100	6
A73 0200 04	2	1	4		100	4	●	A74 0200 04	2	1	4	20	100	4	●
A73 0200 100 06					100	6	●	A74 0200 100 06					20	100	6
A73 0250 04	2.5	1.25	4		100	4	○	A74 0250 04	2.5	1.25	4	25	100	4	○
A73 0250 100 06					100	6	○	A74 0250 100 06					25	100	6
A73 0300 04	3	1.5	5		100	4	○	A74 0300 04	3	1.5	5	30	100	4	●
A73 0300 100 06					100	6	●	A74 0300 100 06					30	100	6
A73 0400	4	2	8		100	4	●	A74 0400	4	2	8	40	100	4	●
A73 0400 100 06					100	6	●	A74 0400 100 06					40	100	6
A73 0500	5	2.5	9		100	5	●	A74 0500	5	2.5	9	50	100	5	○
A73 0500 100 06					100	6	○	A74 0500 100 06					50	100	6
A73 0600 100	6	3	10		100	6	●	A74 0600 100	6	3	10	60	100	6	●
A73 0600 150					150	6	●	A74 0600 150					60	150	6
A73 0800 100	8	4	12		100	8	●	A74 0800 100	8	4	12	60	100	8	●
A73 0800 150					150	8	●	A74 0800 150					80	150	8
A73 1000 125	10	5	14		125	10	●	A74 1000 125	10	5	14	85	125	10	●
A73 1000 150					150	10	●	A74 1000 150					100	150	10
A73 1200 125	12	6	16		125	12	●	A74 1200 125	12	6	16	85	125	12	●
A73 1200 150					150	12	●	A74 1200 150					110	150	12
A73 1400 150	14	7	32		150	14	●	A74 1400 150	14	7	32	110	150	14	●
A73 1400 200					200	14	●	A74 1400 200					150	200	14
A73 1600 150	16	8	32		150	16	●	A74 1600 150	16	8	32	110	150	16	●
A73 1600 200					200	16	●	A74 1600 200					150	200	16
A73 1800 150	18	9	38		150	18	○	A74 1800 150	18	9	38	110	150	18	○
A73 1800 200					200	18	○	A74 1800 200					150	200	18
A73 2000 150	20	10	38		150	20	○	A74 2000 150	20	10	38	110	150	20	○
A73 2000 200					200	20	○	A74 2000 200					150	200	20

BN 30
BN 45
BN 60
BN 60X
DM70 -
BN 70
BN GR

Material Group | Material-Gruppe | Groupe Matière | Gruppo Materiali | 材质主类

Cutting Parameter

N01	N02	N03	K01	K02	P01	P02	P03	M01	M02	S01	S02	S03	H01	H02	O01	O02
-----	-----	-----	-----	-----	-----	-----	-----	-----	-----	-----	-----	-----	-----	-----	-----	-----

407

BN 60 MINIATURE BALLNOSE CUTTERS, 2 FLUTES

- VHM BN 60 Radiuskleinstschaftfräser, 2 Zähne
- Micro-frese sferiche BN 60, 2 taglienti
- Micro-fraises BN 60 à bout hémisphérique, 2 dents
- 整体硬质合金BN60系列微型球头立铣刀2刃-标准长度



Order Number	Dimension (mm)						B0909
	D	R	l1	l2	L	d2 (h6)	
A75 0020 03	0.2	0.1	0.4		40	3	°
A75 0020 04			0.4		40	4	°
A75 0030 03	0.3	0.15	0.6		40	3	°
A75 0030 04			0.6		40	4	°
A75 0040 03	0.4	0.2	0.8		40	3	°
A75 0040 04			0.8		40	4	°
A75 0050 03	0.5	0.25	1.2		40	3	°
A75 0050 04			1.2		40	4	°
A75 0060 03	0.6	0.3	1.4		40	3	°
A75 0060 04			1.4		40	4	°
A75 0070 03	0.7	0.35	1.6		40	3	°
A75 0070 04			1.6		40	4	°
A75 0080 03	0.8	0.4	1.8		40	3	°
A75 0080 04			1.8		40	4	°
A75 0090 03	0.9	0.45	2		40	3	°
A75 0090 04			2		40	4	°

D mm	Tol. μm
0.1 - 0.7	0 / -12
0.7 - 4.0	0 / -20

Material Group | Material-Gruppe | Groupe Matière | Gruppo Materiali | 材质主类

Cutting Parameter

N01	N02	N03	K01	K02	P01	P02	P03	M01	M02	S01	S02	S03	H01	H02	O01	O02	408
-----	-----	-----	-----	-----	-----	-----	-----	-----	-----	-----	-----	-----	-----	-----	-----	-----	-----

BN 60 TAPER NECK BALANOSE CUTTERS , 2 FLUTES

- VHM BN 60 Standard Torusfräser, 2 Zähne
- Frese sferiche BN 60, collo conico, 2 taglienti
- Fraises 2 tailles BN 60 col conique, 2dents
- 整体硬质合金BN 60 系列 锥颈 立铣刀 2 刃 - 标准长度



Order Number	Dimension (mm)								B0909
	D	R	l1	l2	l3	L	d2 (h6)	y	
A77 0100 020 06 080	1.0	0.5	1.5	4.0	20	60	6	8°	○
A77 0100 040 06 040				4.0	40	75	6	4°	●
A77 0150 020 06 070	1.5	0.8	2.3	7.5	20	60	6	7°	○
A77 0150 040 06 035				7.5	40	75	6	3.5°	○
A77 0200 020 06 067	2.0	1.0	3.0	8.0	20	60	6	6.7°	●
A77 0200 040 06 029				8.0	40	75	6	2.9°	●
A77 0200 040 06 010	2.0	1.0	3.0	8.0	40	75	6	1°	○
A77 0300 020 06 043				10.0	20	60	6	4.3°	●
A77 0300 040 06 022	3.0	1.5	3.5	12.0	40	75	6	2.2°	●
A77 0300 045 06 010				12.0	45	75	6	1°	●
A77 0400 020 06 029	4.0	2.0	4.0	12.0	20	60	6	2.9°	●
A77 0400 040 06 014				20.0	40	75	6	1.4°	○
A77 0400 060 06 010	4.0	2.0	4.0	20.0	60	100	6	1°	○
A77 0500 040 06 007				25.0	40	75	6	0.7°	○
A77 0600 020 06 000	6.0	3.0	6.0	20.0	20	60	6	-	●
A77 0600 040 06 000				40.0	40	75	6	-	○
A77 0600 060 08 010	6.0	3.0	6.0	25.0	60	100	8	1°	●
A77 0600 080 08 010				25.0	80	125	8	1°	○
A77 0800 025 08 000	8.0	4.0	7.0	25.0	25	64	8	-	○
A77 0800 060 08 000				60.0	60	100	8	-	●
A77 0800 075 10 008	8.0	4.0	7.0	30.0	75	125	10	0.8°	○
A77 0800 105 10 006				20.0	105	150	10	0.6°	○
A77 1000 030 10 000	10.0	5.0	8.0	30.0	30	75	10	-	○
A77 1000 075 10 000				75.0	75	125	10	-	○
A77 1000 070 12 008	10.0	5.0	8.0	30.0	70	125	12	0.8°	○
A77 1200 035 12 000				35.0	35	100	12	-	○
A77 1200 070 12 000	12.0	6.0	10.0	70.0	70	125	12	-	○
A77 1200 090 16 013				35.0	90	150	16	1.3°	○

BN 30
BN 45
BN 60
BN 60X
DM70 -
BN70
BN GR

Material Group | Material-Gruppe | Groupe Matière | Gruppo Materiali | 材质主类

Cutting Parameter

N01	N02	N03	K01	K02	P01	P02	P03	M01	M02	S01	S02	S03	H01	H02	O01	O02	408
-----	-----	-----	-----	-----	-----	-----	-----	-----	-----	-----	-----	-----	-----	-----	-----	-----	-----

Note: These recommended cutting data indicators are just for reference. They should be adjusted according to the different cutting condition



H

BN 60 Ballnose Cutters, 4 Flutes - A1L

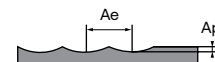

Roughing		H			
Working Material	Hardened steel		Hardened steel		
Properties	45 ≤ HRC < 52		52 ≤ HRC < 68		
Cutting depth, ap	0.10 × D		0.08 × D		
Cutting Width, ae	0.30 × D		0.24 × D		
D	Vc	Fz	Vc	Fz	
3	130	0.022	110	0.018	
4		0.031		0.025	
5		0.039		0.032	
6		0.048		0.039	
8		0.069		0.053	
10		0.091		0.070	
12		0.113		0.088	
14		0.127		0.098	
16		0.139		0.109	
18		0.147		0.120	
20		0.157		0.130	
22		0.168		0.141	
25		0.176		0.154	

BN 60 Ballnose Cutters, 4 Flutes - A1L

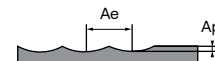

Finishing		H			
Working Material	Hardened steel		Hardened steel		
Properties	45 ≤ HRC < 52		52 ≤ HRC < 68		
Cutting depth, ap	0.05 × D		0.05 × D		
Cutting Width, ae	0.02 × D		0.02 × D		
D	Vc	Fz	Vc	Fz	
3	150	0.018	135	0.015	
4		0.025		0.020	
5		0.031		0.026	
6		0.038		0.031	
8		0.055		0.043	
10		0.073		0.056	
12		0.091		0.071	
14		0.102		0.078	
16		0.111		0.087	
18		0.118		0.096	
20		0.125		0.104	
22		0.134		0.113	
25		0.141		0.123	

Note: These recommended cutting data indicators are just for reference. They should be adjusted according to the different cutting condition



BN 60 Long Ballnose Cutters, 2 Flutes - A71, A72

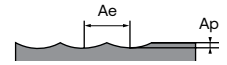

Roughing		H			
Working Material		Hardened steel		Hardened steel	
Properties		45 ≤ HRC < 52		52 ≤ HRC < 68	
Cutting depth, ap		0.10 × D		0.08 × D	
Cutting Width, ae		0.30 × D		0.24 × D	
D	Vc	Fz	Vc	Fz	
1	120	0.009	100	0.006	
2		0.020		0.013	
3		0.032		0.021	
4		0.044		0.030	
5		0.054		0.040	
6		0.068		0.051	
8		0.092		0.070	
10		0.122		0.091	
12		0.150		0.116	
14		0.170		0.128	
16		0.188		0.135	
18		0.204		0.144	
20		0.220		0.155	

BN 60 Long Ballnose Cutters, 2 Flutes - A71, A72

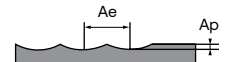

Finishing		H			
Working Material		Hardened steel		Hardened steel	
Properties		45 ≤ HRC < 52		52 ≤ HRC < 68	
Cutting depth, ap		0.05 × D		0.05 × D	
Cutting Width, ae		0.02 × D		0.02 × D	
D	Vc	Fz	Vc	Fz	
1	140	0.006	120	0.004	
2		0.013		0.009	
3		0.020		0.015	
4		0.030		0.022	
5		0.040		0.030	
6		0.051		0.038	
8		0.072		0.055	
10		0.095		0.071	
12		0.118		0.090	
14		0.132		0.100	
16		0.148		0.109	
18		0.162		0.116	
20		0.172		0.121	

- BN 30
- BN 45
- BN 60
- BN 60X
- DM70 -
- BN 70
- BN GR

Note: These recommended cutting data indicators are just for reference. They should be adjusted according to the different cutting condition



BN 30
 BN 45
 BN 60
 BN 60X
 DM70 - BN 70
 BN GR

BN 60 Extra Long Ballnose Cutters, 2 Flutes - A73, A74

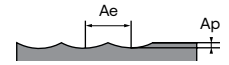

Roughing		H		
Working Material	Hardened steel		Hardened steel	
Properties	45 ≤ HRC < 52		52 ≤ HRC < 68	
Cutting depth, ap	0.10 × D		0.08 × D	
Cutting Width, ae	0.30 × D		0.24 × D	
D	Vc	Fz	Vc	Fz
1	100	0.008	80	0.005
2		0.018		0.012
3		0.029		0.019
4		0.040		0.027
5		0.049		0.036
6		0.061		0.046
8		0.083		0.063
10		0.110		0.082
12		0.135		0.104
14		0.153		0.115
16		0.169		0.122
18		0.184		0.130
20		0.198		0.140

BN 60 Extra Long Ballnose Cutters, 2 Flutes - A73, A74

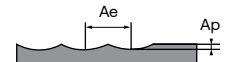

Finishing		H		
Working Material	Hardened steel		Hardened steel	
Properties	45 ≤ HRC < 52		52 ≤ HRC < 68	
Cutting depth, ap	0.05 × D		0.05 × D	
Cutting Width, ae	0.02 × D		0.02 × D	
D	Vc	Fz	Vc	Fz
1	120	0.005	100	0.004
2		0.012		0.008
3		0.018		0.014
4		0.027		0.020
5		0.036		0.027
6		0.046		0.034
8		0.065		0.050
10		0.086		0.064
12		0.106		0.081
14		0.119		0.090
16		0.133		0.098
18		0.146		0.104
20		0.155		0.109

Note: These recommended cutting data indicators are just for reference. They should be adjusted according to the different cutting condition



BN 60 Miniature Ballnose Cutters, 2 Flutes - A75

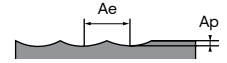

Profiling	H					
Working Material	Hardened steel			Hardened steel		
Properties	45 ≤ HRC < 52			52 ≤ HRC < 68		
D	Ap	N	Fz	Ap	N	Fz
0.2	0.013	50000	0.003		42000	0.003
0.3	0.014	50000	0.006	0.013	42000	0.004
0.4	0.014	50000	0.006	0.019	33600	0.005
0.5	0.023	50000	0.008	0.021	28000	0.008
0.6	0.041	50000	0.008	0.025	28000	0.010
0.7	0.065	47500	0.009	0.037	28000	0.012
0.8	0.078	43000	0.010	0.048	28000	0.014
0.9	0.088	41000	0.011	0.060	25200	0.018

BN 60 Taper Neck Ballnose Cutters, 2 Flutes - A77

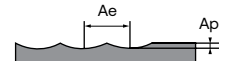

Profiling	H						
Working Material	Hardened steel			Hardened steel			
Properties	45 ≤ HRC < 52			52 ≤ HRC < 68			
D	Effective Length	Ap	N	Fz	Ap	N	Fz
1.0	20	0.048	27000	0.016	0.042	25200	0.015
	40	0.028	24800	0.013	0.022	22300	0.010
1.5	20	0.052	18900	0.024	0.046	17200	0.023
	40	0.032	17300	0.020	0.026	15000	0.016
2.0	20	0.065	14600	0.031	0.059	13230	0.029
	40	0.039	13500	0.028	0.033	11760	0.027
3.0	20	0.078	10100	0.046	0.072	9000	0.044
	40	0.052	9600	0.040	0.046	8500	0.038
	45	0.042	9200	0.035	0.036	8400	0.032
4.0	20	0.085	8630	0.055	0.080	6900	0.058
	40	0.065	7760	0.050	0.060	6700	0.049
	60	0.060	6900	0.040	0.060	6440	0.038
5.0	40	0.075	6350	0.062	0.070	5400	0.062
	20	0.100	5800	0.083	0.095	4700	0.087
6.0	40	0.080	5300	0.075	0.075	4600	0.074
	60	0.070	4800	0.059	0.065	4400	0.058
	80	0.050	4000	0.050	0.045	3600	0.045
	25	0.120	4360	0.112	0.110	3650	0.114
8.0	60	0.080	3700	0.078	0.070	3400	0.077
	75	0.060	3200	0.065	0.050	2800	0.061
	105	0.040	2500	0.062	0.035	2000	0.058
	30	0.130	3600	0.137	0.120	3000	0.140
10.0	70	0.080	2700	0.112	0.070	2300	0.082
	75	0.070	2600	0.085	0.060	2200	0.082
	35	0.140	3100	0.164	0.130	2600	0.164
12.0	70	0.100	2400	0.132	0.090	2000	0.122
	90	0.070	1850	0.130	0.060	1500	0.105

BN 30
BN 45
BN 60
BN 60X
DM70 -
BN 70
BN GR



BALLNOSE



BN 60X

Designed to bring you premium features and benefits
For material application between 40 HRC to 60 HRC

Index - BN 60X, For 40 - 60 HRC

 Suitable for Material Groups
  Adapté pour les matériaux
  适用于材料
 Geeignet für die Materialgruppen
  Adatto per il materiale

P **H**

EDP Number	Type	No. Z	Helix Angle	Coating	Performance	Page Number
A4Q 	BN 60X	2	30°	B0909	P	413
A4R 	BN 60X	2	30°	B0909	P	413
A4S 	BN 60X Miniature Long Neck	2	30°	B0909	P	414

G - General P - Performance

FEATURES & BENEFITS

BN 60X



Top View

1 Radius Tolerance

BN60X Radius Tolerance

Diameter	Radius Tolerance
Ø ≤ 6	+0.000 -0.012
Ø > 6	+0.000 -0.020

2 Enhanced Geometry Design

- Improves finishing application
- Enhances tool stability and rigidity

3 Unique Cutting Edge Treatment

- Reduces tool chipping
- Prolongs tool life

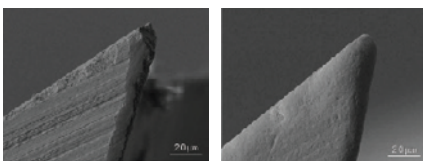

Before

After



4 Suitable to machine material from 40 to 68 HRC for

- Profiling application.
- Semi finishing application.
- Finishing application.

5 Suitable for Materials



End face view - Different grinding method



BN60X
Ballnose



HPMT Standard
Ballnose



1. Radiustoleranz
BN60X Radiustoleranz
2. Verbesserte Werkzeuggeometrie
Verbessert die Werkzeugstabilität und -steifigkeit
Verbessert die Schlichtfräsanwendung
3. Einzigartige Behandlung der Schneidkanten
Reduziert das Absplittern des Werkzeugs
Verlängert die Werkzeuglebensdauer
4. Geeignet Für Materialhärte von 40 bis 60 HRC an:
Profilfräsanwendung
Vorschlichfräsanwendung
Schlichtfräsanwendung
5. Geeignet für die Materialgruppen P, H



1. 圆弧公差
BN60X。
2. 增强刀具几何设计
增强刀具稳定性和刚性。
提高精加工。
3. 特殊切削刃设置
减少刀具磨损。
提高刀具寿命。
4. 适用于 40 至 68 HRC 洛氏硬度加工材料
仿形铣削。
半加工。
精加工。
5. 适用于材料 P, H



1. Tolleranza del raggio
Tolleranza raggio BN60X
2. Design geometrico migliorato
Migliora l'applicazione di finitura
Migliora la stabilità e la rigidità dell'utensile
3. Trattamento all'avanguardia unico nel suo genere
Riduce la scheggiatura degli utensili
Prolunga la vita dell'utensile
4. Adatto a lavorare materiau da 40 a 60 HRC per
Applicazione di profilatura
Applicazione di semifinitura
Applicazione di finitura
5. Adatto per materiali P, H



1. Tolerance du Rayon
BN60X Radius Tolerance
2. Conception de la Géométrie Améliorée
Améliore la rigidité et la stabilité de l'outil
Améliore l'application de finition
3. Préparation Unique de L'arete de Coupe
Réduit l'écaillage des outils
Prolonge la durée de vie de l'outil
4. Convient pour L'usinage des Matieres de 40 À 60 HRC
Application de copiage
Application de semi finition
Application de finition
5. Adapté aux matériaux P, H

BN 60X BALLNOSE CUTTERS / WITH RECESS, 2 FLUTES

- VHM BN 60X Standard Radiusschaftfräser, 2 Zähne
- Frese sferiche BN 60X, 2 taglienti
- Fraises BN 60X Standard, à bout hémisphérique, 2 dents
- 整体硬质合金 BN 60X 系列 2刀球头铣刀

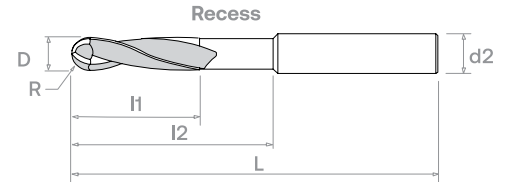
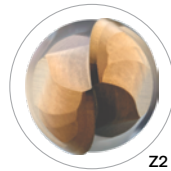
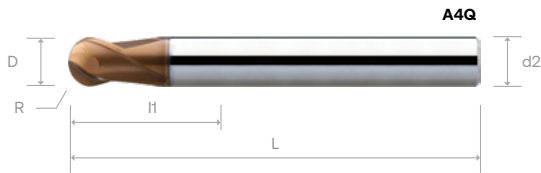

Order Number	Dimension (mm)						B0909	Order Number	Dimension (mm)						B0909
	D	R	I1	I2	L	d2 (h6)			D	R	I1	I2	L	d2 (h6)	
A4Q 0050	0.5	0.25	0.5		50	4	◦	A4R 0050	0.5	0.25	0.5		50	4	
A4Q 0060	0.6	0.3	0.6		50	4	•	A4R 0060	0.6	0.3	0.6		50	4	
A4Q 0080	0.8	0.4	0.8		50	4	•	A4R 0080	0.8	0.4	0.8		50	4	
A4Q 0100	1	0.5	1		50	4	•	A4R 0100	1	0.5	1	4	50	4	◦
A4Q 0150	1.5	0.75	1.5		50	4	•	A4R 0150	1.5	0.75	1.5	6	50	4	◦
A4Q 0200	2	1	2		50	4	•	A4R 0200	2	1	2	8	50	4	•
A4Q 0250	2.5	1.25	2.5		50	4	•	A4R 0250	2.5	1.25	2.5	10	50	4	◦
A4Q 0300 050 04	3	1.5	3		50	4	◦	A4R 0300 050 04	3	1.5	3	14	50	4	◦
A4Q 0300 050 06				50	6	•	A4R 0300 050 06	14				50	6	•	
A4Q 0400 050 06	4	2	4		50	6	•	A4R 0400 050 06	4	2	4	20	50	6	•
A4Q 0500 050 06	5	2.5	5		50	6	•	A4R 0500 050 06	5	2.5	5	20	50	6	◦
A4Q 0600 050	6	3	6		50	6	•	A4R 0600 050	6	3	6	20	50	6	◦
A4Q 0600 060				60	6	•	A4R 0600 060	30				60	6	•	
A4Q 0800	8	4	8		64	8	•	A4R 0800	8	4	8	30	64	8	•
A4Q 1000	10	5	10		70	10	•	A4R 1000	10	5	10	32	70	10	◦
A4Q 1200	12	6	12		75	12	•	A4R 1200	12	6	12	38	75	12	◦
A4Q 1600	16	8	16		90	16	•	A4R 1600	16	8	16	46	90	16	◦
A4Q 1800	18	9	18		100	18	◦	A4R 1800	18	9	18	53	100	18	◦
A4Q 2000	20	10	20		100	20	◦	A4R 2000	20	10	20	58	100	20	◦

Diameter (mm)	Radius Tolerance
R ≤ 2.5	±0.005
2.5 ≤ R ≤ 6	±0.010
6 < R	±0.015

Material Group | Material-Gruppe | Groupe Matière | Gruppo Materiali | 材质主类

Cutting Parameter

N01	N02	N03	K01	K02	P01	P02	P03	M01	M02	S01	S02	S03	H01	H02	O01	O02	415
-----	-----	-----	-----	-----	-----	-----	-----	-----	-----	-----	-----	-----	-----	-----	-----	-----	-----

BN 60X MINIATURE BALLNOSE CUTTERS WITH LONG NECK, 2 FLUTES

- VHM BN 60 X Kleinstradiusfräser mit langem Hals, 2 Zähne
- Micro-frese sferiche BN 60X, con collo lungo, 2 taglienti
- Micro-fraises BN 60X à bout hémisphérique avec cou long, 2 dents
- 整体硬质合金 BN 60X 系列 微小径2刃长颈球头铣刀

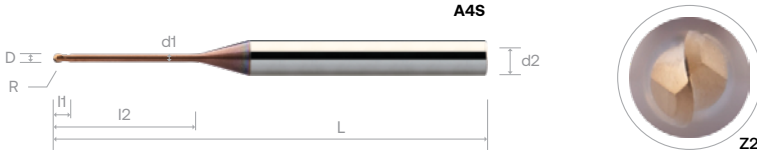

Order Number	Dimension (mm)							B0909	Order Number	Dimension (mm)							B0909
	D	R	I1	I2	L	d1	d2 (h6)			D	R	I1	I2	L	d1	d2 (h6)	
A4S 0020 050 0400	0.2	0.10	0.15	-	50	-	4	•	A4S 0150 050 0400	1.5	0.75	1.35	-	50	-	4	•
A4S 0020 050 0400 005				0.5	50	0.17	4	•	A4S 0150 050 0400 080				8	50	1.4	4	•
A4S 0020 050 0400 010				1	50	0.17	4	•	A4S 0150 050 0400 120				12	50	1.4	4	•
A4S 0020 050 0400 015	0.3	0.15	0.23	1.5	50	0.17	4	•	A4S 0150 050 0400 160	16	50	1.4	4	•			
A4S 0030 050 0400				-	50	-	4	•	A4S 0150 060 0400	-	60	-	4	•			
A4S 0030 050 0400 010				1	50	0.27	4	•	A4S 0150 060 0400 180	18	60	1.4	4	•			
A4S 0030 050 0400 020	0.4	0.2	0.30	2	50	0.27	4	•	A4S 0160 050 0400	-	50	-	4	•			
A4S 0030 050 0400 030				3	50	0.27	4	•	A4S 0160 050 0400 080	8	50	1.5	4	•			
A4S 0040 050 0400				-	50	-	4	•	A4S 0160 050 0400 120	12	50	1.5	4	•			
A4S 0040 050 0400 010	0.5	0.25	0.35	1	50	0.37	4	•	A4S 0160 050 0400 160	16	50	1.5	4	•			
A4S 0040 050 0400 020				2	50	0.37	4	•	A4S 0160 060 0400	-	60	-	4	•			
A4S 0040 050 0400 030				3	50	0.37	4	•	A4S 0160 060 0400 200	20	60	1.5	4	•			
A4S 0040 050 0400 040	0.6	0.30	0.42	4	50	0.37	4	•	A4S 0180 050 0400	-	50	-	4	•			
A4S 0040 050 0400 050				5	50	0.37	4	•	A4S 0180 050 0400 080	8	50	1.7	4	•			
A4S 0050 050 0400				-	50	-	4	•	A4S 0180 050 0400 120	12	50	1.7	4	•			
A4S 0050 050 0400 020	0.8	0.40	0.48	2	50	0.45	4	•	A4S 0180 050 0400 160	16	50	1.7	4	•			
A4S 0050 050 0400 030				3	50	0.45	4	•	A4S 0180 060 0400	-	60	-	4	•			
A4S 0050 050 0400 040				4	50	0.45	4	•	A4S 0180 060 0400 200	20	60	1.7	4	•			
A4S 0050 050 0400 050	1.0	0.50	0.80	5	50	0.45	4	•	A4S 0200 050 0400	-	50	-	4	•			
A4S 0050 050 0400 060				6	50	0.45	4	•	A4S 0200 050 0400 040	4	50	1.9	4	•			
A4S 0050 050 0400 080				8	50	0.45	4	•	A4S 0200 050 0400 060	6	50	1.9	4	•			
A4S 0060 050 0400	1.2	0.60	1.08	-	50	-	4	•	A4S 0200 050 0400 080	8	50	1.9	4	•			
A4S 0060 050 0400 020				2	50	0.55	4	•	A4S 0200 050 0400 100	10	50	1.9	4	•			
A4S 0060 050 0400 030				3	50	0.55	4	•	A4S 0200 050 0400 120	12	50	1.9	4	•			
A4S 0060 050 0400 040	1.4	0.70	1.26	4	50	0.55	4	•	A4S 0200 050 0400 140	14	50	1.9	4	•			
A4S 0060 050 0400 050				5	50	0.55	4	•	A4S 0200 050 0400 160	16	50	1.9	4	•			
A4S 0060 050 0400 060				6	50	0.55	4	•	A4S 0200 060 0400	-	60	-	4	•			
A4S 0060 050 0400 080	1.4	0.70	1.26	8	50	0.55	4	•	A4S 0200 060 0400 180	18	60	1.9	4	•			
A4S 0080 050 0400				-	50	-	4	•	A4S 0200 060 0400 200	20	60	1.9	4	•			
A4S 0080 050 0400 020				2	50	0.75	4	•	A4S 0200 060 0400 220	22	60	1.9	4	•			
A4S 0080 050 0400 040	1.4	0.70	1.26	4	50	0.75	4	•	A4S 0200 075 0400	-	75	-	4	•			
A4S 0080 050 0400 050				5	50	0.75	4	•	A4S 0200 075 0400 250	25	75	1.9	4	•			
A4S 0080 050 0400 060				6	50	0.75	4	•	A4S 0200 075 0400 300	30	75	1.9	4	•			
A4S 0080 050 0400 070	1.4	0.70	1.26	7	50	0.75	4	•	A4S 0300 050 0600	-	50	-	6	•			
A4S 0080 050 0400 080				8	50	0.75	4	•	A4S 0300 050 0600 080	8	50	2.8	6	•			
A4S 0080 050 0400 100				10	50	0.75	4	•	A4S 0300 050 0600 100	10	50	2.8	6	•			
A4S 0100 050 0400	1.4	0.70	1.26	-	50	-	4	•	A4S 0300 060 0600	-	60	-	6	•			
A4S 0100 050 0400 030				3	50	0.9	4	•	A4S 0300 060 0600 160	16	60	2.8	6	•			
A4S 0100 050 0400 040				4	50	0.9	4	•	A4S 0300 060 0600 200	20	60	2.8	6	•			
A4S 0100 050 0400 050	1.4	0.70	1.26	5	50	0.9	4	•	A4S 0300 075 0600	-	75	-	6	•			
A4S 0100 050 0400 060				6	50	0.9	4	•	A4S 0300 075 0600 250	25	75	2.8	6	•			
A4S 0100 050 0400 070				7	50	0.9	4	•	A4S 0300 075 0600 300	30	75	2.8	6	•			
A4S 0100 050 0400 080	1.4	0.70	1.26	8	50	0.9	4	•	A4S 0300 075 0600 350	35	75	2.8	6	•			
A4S 0100 050 0400 090				9	50	0.9	4	•	A4S 0400 050 0600	-	50	-	6	•			
A4S 0100 050 0400 100				10	50	0.9	4	•	A4S 0400 050 0600 100	10	50	3.7	6	•			
A4S 0100 050 0400 120	1.4	0.70	1.26	12	50	0.9	4	•	A4S 0400 060 0600	-	60	-	6	•			
A4S 0100 050 0400 140				14	50	0.9	4	•	A4S 0400 060 0600 160	16	60	3.7	6	•			
A4S 0100 050 0400 160				16	50	0.9	4	•	A4S 0400 060 0600 200	20	60	3.7	6	•			
A4S 0100 060 0400	1.4	0.70	1.26	-	60	-	4	•	A4S 0400 075 0600	-	75	-	6	•			
A4S 0100 060 0400 200				20	60	0.9	4	•	A4S 0400 075 0600 250	25	75	3.7	6	•			
A4S 0120 050 0400				-	50	-	4	•	A4S 0400 075 0600 300	30	75	3.7	6	•			
A4S 0120 050 0400 060	1.4	0.70	1.26	6	50	1.1	4	•	A4S 0400 075 0600 350	35	75	3.7	6	•			
A4S 0120 050 0400 080				8	50	1.1	4	•	A4S 0400 100 0600	-	100	-	6	•			
A4S 0120 050 0400 100				10	50	1.1	4	•	A4S 0400 100 0600 400	40	100	3.7	6	•			
A4S 0120 050 0400 120	1.4	0.70	1.26	12	50	1.1	4	•	A4S 0400 100 0600 450	45	100	3.7	6	•			
A4S 0140 050 0400				-	50	-	4	•	A4S 0400 100 0600 500	50	100	3.7	6	•			
A4S 0140 050 0400 080				8	50	1.3	4	•									
A4S 0140 050 0400 120	1.4	0.70	1.26	12	50	1.3	4	•									
A4S 0140 050 0400 160				16	50	1.3	4	•									

Diameter	Radius Tolerance
Ø ≤ 3	+0.000 -0.012
Ø > 3	+0.000 -0.020

Material Group | Material-Gruppe | Groupe Matière | Gruppo Materiali | 材质主类

Cutting Parameter

N01	N02	N03	K01	K02	P01	P02	P03	M01	M02	S01	S02	S03	H01	H02	O01	O02	416 - 417
-----	-----	-----	-----	-----	-----	-----	-----	-----	-----	-----	-----	-----	-----	-----	-----	-----	-----------

Recommended Cutting Data



Note: These recommended cutting data indicators are just for reference. They should be adjusted according to the different cutting condition



BN 60X Ballnose Cutters, 2 Flutes - A4Q, A4R

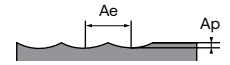

Roughing	P		H			
Working Material	Prehardened steel		Hardened steel		Hardened steel	
Properties	35 ≤ HRC < 45		45 ≤ HRC < 52		52 ≤ HRC < 68	
Cutting depth, ap	0.06 × D		0.05 × D		0.03 × D	
Cutting Width, ae	0.30 × D		0.25 × D		0.15 × D	
D	Vc	Fz	Vc	Fz	Vc	Fz
1	250	0.020	220	0.016	180	0.012
2		0.027		0.024		0.022
3		0.041		0.037		0.035
4		0.056		0.051		0.049
5		0.072		0.065		0.063
6		0.087		0.081		0.079
8		0.118		0.109		0.107
10		0.153		0.145		0.140
12		0.190		0.180		0.178
16		0.244		0.233		0.225
18		0.262		0.257		0.248
20		0.278		0.275		0.270

BN 60X Ballnose Cutters, 2 Flutes - A4Q, A4R

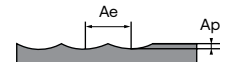

Finishing	P		H			
Working Material	Prehardened steel		Hardened steel		Hardened steel	
Properties	35 ≤ HRC < 45		45 ≤ HRC < 52		52 ≤ HRC < 68	
Cutting depth, ap	0.05 × D		0.05 × D		0.04 × D	
Cutting Width, ae	0.02 × D		0.02 × D		0.02 × D	
D	Vc	Fz	Vc	Fz	Vc	Fz
1	260	0.017	230	0.014	190	0.011
2		0.021		0.020		0.019
3		0.033		0.032		0.030
4		0.048		0.044		0.041
5		0.062		0.057		0.053
6		0.076		0.070		0.066
8		0.105		0.096		0.091
10		0.134		0.123		0.118
12		0.167		0.156		0.149
16		0.216		0.199		0.190
18		0.235		0.218		0.210
20		0.254		0.232		0.226

BN 30
BN 45
BN 60
BN 60X
DM70 - BN 70
BN GR

Recommended Cutting Data



Note: These recommended cutting data indicators are just for reference. They should be adjusted according to the different cutting condition



BN 60X Miniature Long Neck Ballnose Cutters, 2 Flutes - A4S

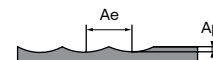

Profiling		P			H					
Working Material		Prehardened steel			Hardened steel			Hardened steel		
Properties		35 ≤ HRC < 45			45 ≤ HRC < 52			52 ≤ HRC < 68		
D	Effective Length	Ap	N	Fz	Ap	N	Fz	Ap	N	Fz
0.2	0.5	0.016	50000	0.003		45500	0.003	0.012	42000	0.003
	1.0	0.011	50000	0.003	0.009	45500	0.003	0.008	42000	0.003
	1.5	0.006	45900	0.003	0.005	40500	0.003	0.005	37800	0.002
0.3	1.0	0.017	50000	0.005	0.014	45000	0.004	0.013	42000	0.004
	2.0	0.010	45900	0.004	0.008	40500	0.004	0.007	37800	0.004
	3.0	0.006	45900	0.004	0.005	40500	0.004	0.005	37800	0.004
0.4	1.0	0.032	50000	0.007	0.026	46800	0.007	0.024	43680	0.007
	2.0	0.022	50000	0.005	0.018	46800	0.005	0.017	43680	0.005
	3.0	0.013	36720	0.005	0.010	32400	0.005	0.010	36288	0.004
	4.0	0.008	36720	0.005	0.007	32400	0.005	0.006	36288	0.004
	5.0	0.006	32640	0.005	0.005	32400	0.005	0.005	26880	0.004
0.5	2.0	0.028	44200	0.016	0.023	39000	0.011	0.021	36400	0.009
	3.0	0.024	39780	0.008	0.020	35100	0.008	0.018	25200	0.008
	4.0	0.016	30600	0.008	0.013	32400	0.008	0.012	25200	0.008
	5.0	0.014	30600	0.008	0.012	32400	0.008	0.011	25200	0.008
	6.0	0.010	27200	0.008	0.008	24000	0.007	0.008	22400	0.007
0.6	8.0	0.006	27200	0.008	0.005	24000	0.007	0.005	22400	0.007
	2.0	0.050	50000	0.019	0.041	48000	0.018	0.038	44800	0.015
	3.0	0.033	50000	0.016	0.027	48000	0.014	0.025	44800	0.011
	4.0	0.021	48960	0.015	0.017	43200	0.013	0.016	40320	0.009
	5.0	0.016	39780	0.012	0.013	35100	0.011	0.012	32760	0.009
	6.0	0.012	39780	0.012	0.010	35100	0.011	0.009	32760	0.009
0.8	8.0	0.012	27200	0.011	0.010	24000	0.010	0.009	22400	0.008
	2.0	0.096	50000	0.024	0.078	48000	0.027	0.072	44800	0.021
	4.0	0.062	50000	0.024	0.051	48000	0.027	0.047	44800	0.021
	5.0	0.047	48960	0.022	0.038	43200	0.025	0.035	40320	0.019
	6.0	0.034	42840	0.020	0.027	37800	0.019	0.025	35280	0.018
	7.0	0.025	39100	0.017	0.020	34500	0.016	0.019	32200	0.016
	8.0	0.016	35360	0.015	0.013	31200	0.014	0.012	29120	0.013
1.0	10.0	0.016	27200	0.013	0.013	24000	0.013	0.012	22400	0.012
	3.0	0.160	45900	0.033	0.130	43200	0.032	0.120	37800	0.030
	4.0	0.112	45900	0.033	0.091	43200	0.032	0.084	37800	0.030
	5.0	0.072	39780	0.032	0.059	43200	0.029	0.054	32760	0.028
	6.0	0.048	38556	0.030	0.039	38880	0.029	0.036	29484	0.023
	7.0	0.048	33048	0.020	0.039	31590	0.021	0.036	27216	0.020
	8.0	0.048	33048	0.020	0.039	31590	0.021	0.036	27216	0.018
	9.0	0.036	33048	0.020	0.029	31590	0.021	0.027	27216	0.018
	10.0	0.030	33048	0.020	0.025	31590	0.021	0.023	27216	0.018
	12.0	0.020	24480	0.019	0.016	21600	0.018	0.015	20160	0.017
	14.0	0.016	24480	0.019	0.013	21600	0.018	0.012	20160	0.017
1.2	16.0	0.012	24480	0.019	0.010	21600	0.018	0.009	20160	0.017
	20.0	0.008	18360	0.018	0.007	16200	0.016	0.006	15120	0.016
	6.0	0.088	31824	0.032	0.072	30240	0.034	0.066	26208	0.020
	8.0	0.048	31824	0.032	0.039	30240	0.034	0.036	26208	0.020
1.4	10.0	0.042	29376	0.022	0.034	27000	0.020	0.032	24192	0.018
	12.0	0.036	29376	0.022	0.029	25920	0.020	0.027	24192	0.018
	8.0	0.088	27846	0.032	0.072	24570	0.031	0.066	22932	0.030
1.5	12.0	0.042	25704	0.024	0.034	22680	0.023	0.032	21168	0.022
	16.0	0.028	19040	0.023	0.023	16800	0.022	0.021	15680	0.021
	8.0	0.072	27846	0.033	0.059	24570	0.029	0.054	22932	0.027
1.5	12.0	0.072	25704	0.027	0.059	22680	0.025	0.054	21168	0.027
	16.0	0.030	19040	0.025	0.025	16800	0.023	0.023	15680	0.021
	18.0	0.030	19040	0.025	0.025	16800	0.023	0.023	15680	0.021

cont'd ▶

BN 30
BN 45
BN 60
BN 60X
DM70 -
BN70
BN GR

Note: These recommended cutting data indicators are just for reference. They should be adjusted according to the different cutting condition



BN 60X Miniature Long Neck Ballnose Cutters, 2 Flutes - A4S

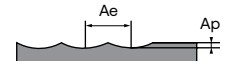

Profiling		P			H					
Working Material		Prehardened steel			Hardened steel			Hardened steel		
Properties		35 ≤ HRC < 45			45 ≤ HRC < 52			52 ≤ HRC < 68		
D	Effective Length	Ap	N	Fz	Ap	N	Fz	Ap	N	Fz
1.6	8.0	0.176	30940	0.040	0.143	27300	0.039	0.132	23660	0.034
	12.0	0.078	27846	0.039	0.064	24570	0.038	0.059	21294	0.030
	16.0	0.048	23868	0.028	0.039	21060	0.027	0.036	19656	0.025
	20.0	0.032	17680	0.026	0.026	15600	0.025	0.024	14560	0.024
1.8	8.0	0.208	28730	0.042	0.169	25350	0.040	0.156	23660	0.036
	12.0	0.084	23868	0.032	0.068	21060	0.030	0.063	19656	0.027
	16.0	0.054	23868	0.032	0.044	21060	0.030	0.041	19656	0.027
	20.0	0.036	17680	0.029	0.029	15600	0.025	0.027	14560	0.025
2.0	4.0	0.320	26775	0.067	0.260	23625	0.064	0.240	22050	0.060
	6.0	0.320	26775	0.060	0.260	23625	0.057	0.240	22050	0.054
	8.0	0.224	26775	0.060	0.182	23625	0.057	0.168	22050	0.054
	10.0	0.168	24990	0.054	0.137	22050	0.051	0.126	19110	0.039
	12.0	0.096	22491	0.054	0.078	19845	0.051	0.072	17199	0.038
	14.0	0.096	22491	0.047	0.078	18428	0.044	0.072	15876	0.032
	16.0	0.096	20885	0.032	0.078	18428	0.040	0.072	15876	0.029
	18.0	0.072	19278	0.032	0.059	18428	0.037	0.054	15876	0.029
	20.0	0.060	19278	0.032	0.049	18428	0.030	0.045	15876	0.029
	22.0	0.040	15173	0.030	0.033	13388	0.028	0.030	14994	0.027
3.0	25.0	0.040	14280	0.030	0.033	12600	0.028	0.030	14112	0.026
	30.0	0.024	14280	0.030	0.020	12600	0.028	0.018	14112	0.026
	8.0	0.480	20400	0.100	0.390	18000	0.085	0.360	16800	0.090
	10.0	0.336	20400	0.100	0.273	18000	0.085	0.252	16800	0.090
	16.0	0.252	19040	0.080	0.205	16800	0.068	0.189	14560	0.065
	20.0	0.144	15912	0.060	0.117	14040	0.056	0.108	12096	0.054
4.0	25.0	0.096	15912	0.060	0.078	14040	0.056	0.072	12096	0.054
	30.0	0.096	14668	0.060	0.078	12960	0.055	0.072	12096	0.054
	35.0	0.064	10880	0.057	0.052	9600	0.053	0.048	10752	0.050
	10.0	0.480	14663	0.134	0.390	12938	0.125	0.360	12075	0.119
	16.0	0.336	14663	0.134	0.273	12938	0.125	0.252	12075	0.119
	20.0	0.336	12708	0.108	0.273	11213	0.101	0.252	10465	0.100
	25.0	0.192	11437	0.098	0.156	10092	0.101	0.144	9419	0.086
	30.0	0.128	10558	0.081	0.104	9316	0.077	0.096	8694	0.072
	35.0	0.080	10558	0.081	0.065	9316	0.077	0.060	8694	0.072
	40.0	0.080	10558	0.081	0.065	9316	0.077	0.060	8694	0.072
45.0	0.080	7820	0.076	0.065	6900	0.070	0.060	6440	0.067	
50.0	0.080	7820	0.076	0.065	6900	0.070	0.060	6440	0.067	

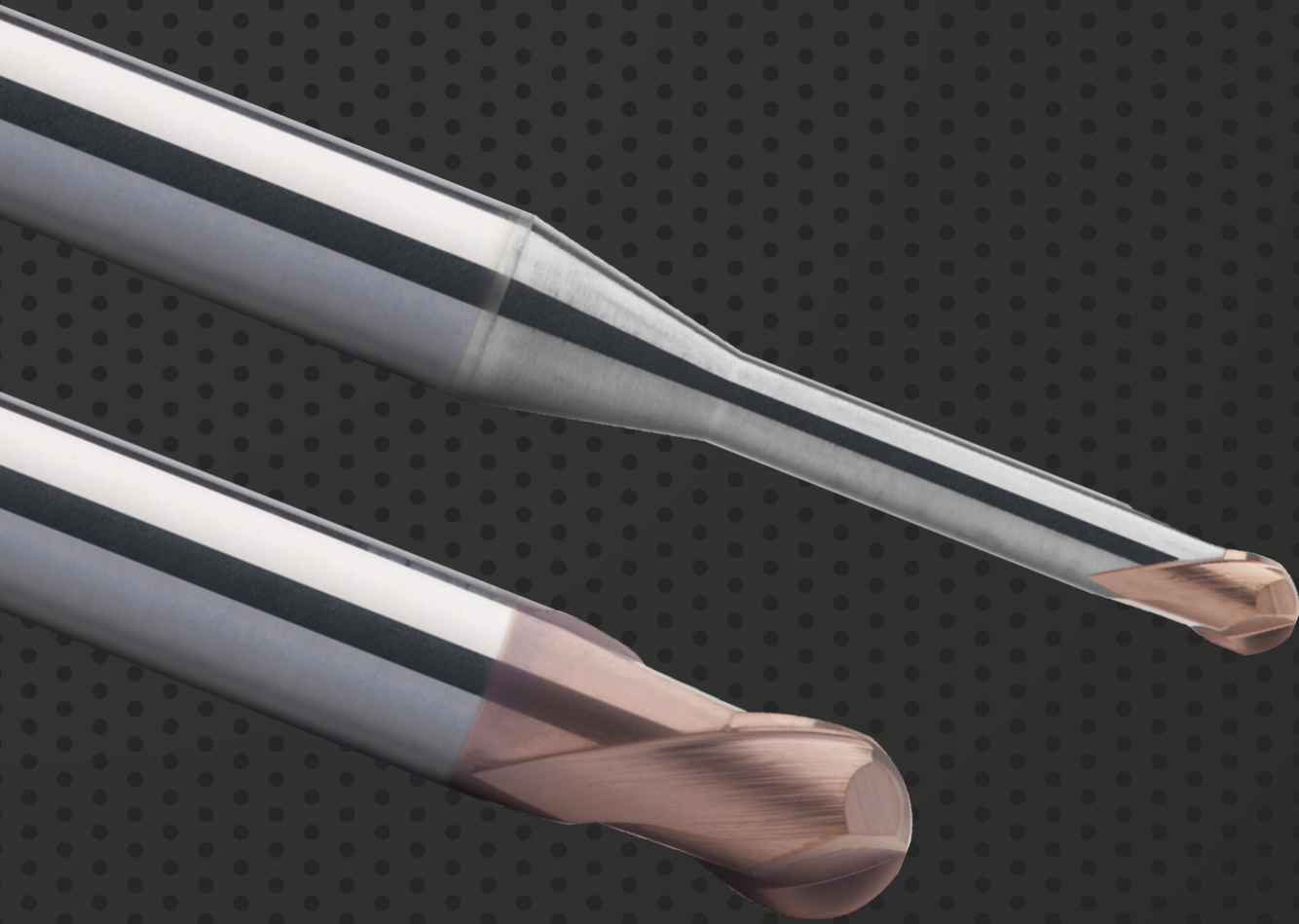

BALLNOSE



DM70 (BN 70)

For Mould & Die applications on hard material
For material application up to 70 HRC

Index - DM70 (BN 70), For 50 - 70 HRC

 Suitable for Material Groups
  Adapté pour les matériaux
  适用于材料
 Geeignet für die Materialgruppen
  Adatto per il materiale

H

	EDP Number	Type	No. Z	Helix Angle	Coating	Performance	Page Number
NEW	A5Q 	BN 70	2	30°	B0909+	P	424
NEW	A5R 	BN 70, Recess	2	30°	B0909+	P	424
NEW	A5S 	BN 70 Miniature Torus Long Neck	2	30°	B0909+	P	427

G - General P - Performance

DM70 (BN 70)

MAIN FEATURES

1 New Improved Coating formula (B0909+)

- Higher hardness coating with higher silicon content
- Increased machining speed capability when cutting materials >50HRC
- Higher abrasive wear resistance, allowing for longer tool life
- Enhanced heat resistance for hard machining materials

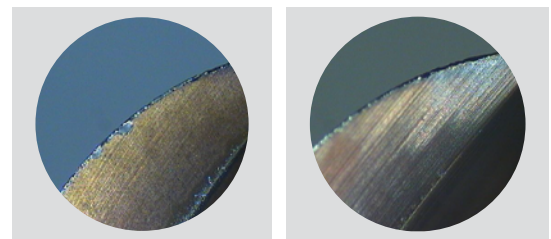

2 Tightened Tolerance

- Higher eccentricity and higher concentricity
- Perfect for modern high precision tool holders
- Deliver high precision machining

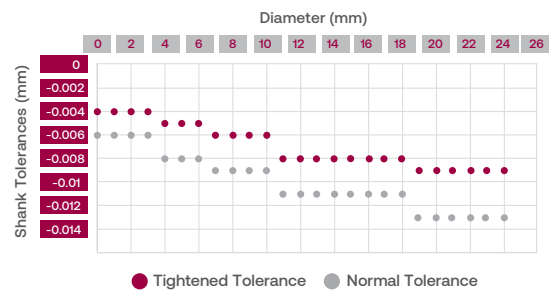

3 Cutting Edge Preparation

- Better stress distribution on the cutting edge to prolong tool life
- Reduced micro chipping and uneven sharp edges for superior surface finishing
- Minimize material adhesion on the cutting edge; reduces burring chance

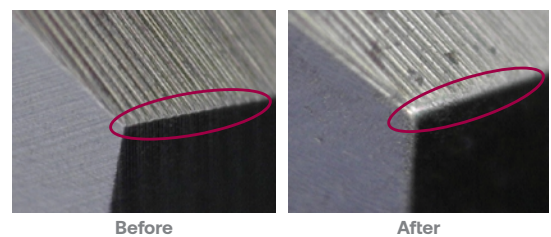

4 Ultra Fine Grain Cemented Carbide (UF+)

- Higher durability for material removal rate (MRR)
- Higher overall tool toughness, strength and edge retention
- Excellent performance in machining high hardness materials
- Reduce the risk of chipping and increases reliability

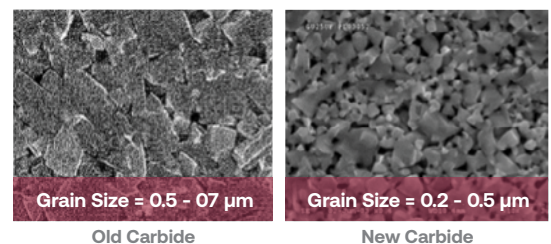



1. verbesserte Beschichtung (B0909+)
Beschichtung mit höherem Siliziumgehalt
höhere Bearbeitungsgeschwindigkeit beim Schneiden von Materialien >50HRC
höhere Verschleißfestigkeit, dadurch längere Werkzeugstandzeit
Verbesserte Hitzebeständigkeit beim Schneiden von Materialien >50HRC
2. engere Toleranz
Höhere Exzentrizität und höhere Rundlaufgenauigkeit
Perfekt für moderne Präzisionswerkzeugaufnahmen
Lieferrn hochpräzise Bearbeitungen
3. Schneidkantenpräparation
Bessere Belastungsverteilung an der Schneide zur Verlängerung der Werkzeugstandzeit
Geringere Mikroausbrüche und ungleichmäßige scharfe Kanten für eine bessere Oberflächengüte
Minimierung der Materialanhaftung an der Schneidkante; reduziert die Gratbildung.
4. ultrafeinkörniges Hartmetall (UF+)
höhere Standzeit bei der Materialabtragsrate
höhere Werkzeugfestigkeit, Beständigkeit und Kantenstabilität.
ausgezeichnete Leistung bei der Bearbeitung von härteren Stählen.
verringert das Risiko von Ausbrüchen und erhöht die Zuverlässigkeit



1. 新改良的涂层配方(B0909+)
含硅量较高的高硬度涂层
使用于材料 >50HRC 时, 有较高的加工速度
更高的耐磨性可延长刀具寿命
增强高硬度加工材料的耐热性
2. 缩小公差
具有更高的偏心率和同心度
完美配合于先进高精度夹持工具
可用于高精度加工
3. 刃口处理
改善切削刃上的应力分布可延长刀具寿命
减少微小崩损及不均匀刃锋, 提高工件光洁度
最大限度地减少切削刃上的材料沾黏; 减少毛刺产生
4. 超细颗粒硬质合金 (UF+)
材料去除率 (MRR) 的耐久性更高
更高的韧性、强度和刃口坚固
加工高硬度材料的性能更优越
减轻崩损, 提高稳定性



1. Formula migliorata del rivestimento (B0909+)
Rivestimento di maggiore durezza con un contenuto di silicio più elevato
Maggiore velocità di lavorazione durante il taglio di materiali >50HRC
Maggiore resistenza all'usura, che consente una maggiore durata dell'utensile
Maggiore resistenza al calore per materiali di lavorazione duri
2. Tolleranze piu' strette
Maggiore precisione di concentricità
Ideale per i moderni portautensili ad alta precisione
Fornire lavorazioni di alta precisione
3. Preparazione del tagliente
Migliore distribuzione delle sollecitazioni sul tagliente per prolungare la durata dell'utensile
Riduce le microscheggiature del tagliente per una migliore finitura superficiale
Riduce al minimo l'incollatura del materiale sul tagliente e la possibilità di sbavature
4. Metallo duro cementato a grana ultra fine (UF+)
Maggiore durata per alta rimozione del materiale (MRR)
Maggiore tenacità dell'utensile, resistenza e durata del tagliente
Eccellenti prestazioni nella lavorazione di materiali temprati
Riduce il rischio di scheggiatura e aumenta l'affidabilità



1. Nouvelle formule de revêtement améliorée (B0909+)
Revêtement de dureté plus élevée avec une teneur en silicium plus élevée
Capacité de vitesse d'usinage accrue lors de la coupe de matériaux > 50HRC
Résistance à l'usure abrasive plus élevée, permettant une durée de vie plus longue de l'outil
Résistance à la chaleur améliorée pour les matériaux d'usinage durs
2. Resserrer la tolérance
Excentricité et concentricité plus élevées
Parfait pour les porte-outils modernes de haute précision
Fournir un usinage de haute précision
3. Préparation de pointe
Meilleure répartition des contraintes sur l'arête de coupe pour prolonger la durée de vie de l'outil
Micro-écaillage réduit et arêtes vives inégales pour une finition de surface supérieure
Minimiser l'adhérence du matériau sur l'arête de coupe ; réduit les risques de bavures
4. Carbone cémenté à grain ultra fin (UF+)
Durabilité plus élevée pour le taux d'enlèvement de matière (MRR)
Plus grande ténacité globale de l'outil, résistance et rétention des bords
Excellentes performances dans l'usinage de matériaux de haute dureté
Réduit le risque d'écaillage et augmente la fiabilité

FEATURES & BENEFITS

DM70 (BN 70)

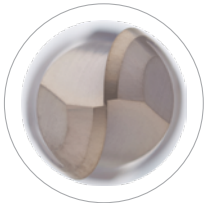

Top View

1 Enhanced Chisel Angle Design

- Further enhanced surface finishing of machining component
- Increases endface wear resistance and tool life
- More reliable to machine high accuracy components
- Perfect for Semi-Finishing and Finishing operations

2 Enhanced Geometry Design

- Higher stability to reduce vibration and chattering
- Shaper radius rake angle to reduce spindle load
- Increases tool life and productivity performance

3 Suitable for Material

H





1. verbesserter Schneidwinkel
verbesserte Oberflächengüte des Bauteils
Erhebliche Erhöhung der Verschleißfestigkeit, der Stirnfläche und der Werkzeugstandzeit
Zuverlässiger bei der Bearbeitung moderner, hochpräziser Komponenten
Perfekt für Semi-Schichten und Schichten.
2. verbesserte Geometrie
Höhere Stabilität zur Reduzierung von Vibrationen
Schärferer Spanwinkel zur Reduzierung der Spindelbelastung
Erhöht die Werkzeugstandzeit und Produktivität
3. Geeignet für Materialgruppe H



1. 增强型凿角设计
进一步提高加工部件的表面光洁度
可有效提高端面耐磨性和延长刀具寿命
加工先进高精度工件更具可靠性
非常适用于半精加工和精加工的操作
2. 增强型几何设计
具有更高的稳定性可减少震动和颤动
成型的半径前角可减少主轴负载
延长刀具寿命和提高其生产效能
3. 适用于加工材料H



1. Design migliorato dell'angolo del tagliente in testa
Ulteriore miglioramento della finitura superficiale del componente di lavorazione
Aumenta la resistenza all'usura delle estremità e la durata dell'utensile
Affidabile per le lavorazioni di alta precisione
Ideale per le operazioni di semifinitura e finitura
2. Nuova geometria migliorata
Maggiore stabilità per vibrazioni ridotte
Angolo di spoglia migliorato per ridurre il carico del mandrino
Aumenta la durata dell'utensile e le prestazioni di produttività
3. Adatto per il materiale H



1. Conception d'angle de ciseau amélioré
Finition de surface encore améliorée du composant d'usinage
Augmente considérablement la résistance à l'usure et la durée de vie de l'outil
Plus fiable pour usiner des composants modernes de haute précision
Parfait pour les opérations de semi-finition et de finition
2. Conception de géométrie améliorée
Stabilité plus élevée pour réduire les vibrations et les vibrations
Angle de coupe du rayon du shaper pour réduire la charge de la broche
Augmente la durée de vie de l'outil et les performances de productivité
3. Adapté aux matériaux H

BN 70 BALLNOSE CUTTERS / WITH RECESS, 2 FLUTES

- VHM BN 70 Radiuschaftfräser, 2 Zähne
- Frese sferiche BN 70, 2 taglianti
- Fraises BN 70, à bout hémisphérique, 2 dents
- 整体硬质合金 BN 70 系列 2刃球头铣刀

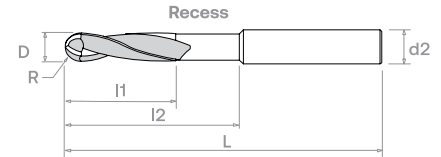
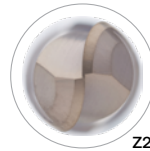
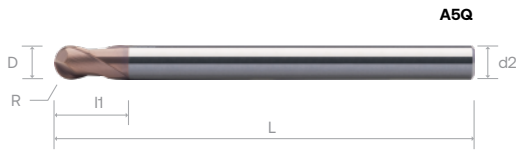

Order Number	Dimension (mm)							B0909+	Order Number	Dimension (mm)							B0909+
	D	R	l1	l2	d3	L	d2(h6)			D	R	l1	l2	d3	L	d2(h6)	
A5Q 0100 050 04	1	0.5	1		50	0.95	4	•	A5R 0100 050 04	1	0.5	1	3	50	0.95	4	◦
A5Q 0100 050 06					50	0.95	6	•	A5R 0100 050 06				5	50	0.95	6	◦
A5Q 0150 050 04	1.5	0.75	1.5		50	1.45	4	•	A5R 0150 050 04	1.5	0.75	1.5	4.5	50	1.45	4	◦
A5Q 0150 050 06					50	1.45	6	◦	A5R 0150 050 06				7.5	50	1.45	6	•
A5Q 0200 050 04	2	1	2		50	1.94	4	•	A5R 0200 050 04	2	1	2	6	50	1.94	4	◦
A5Q 0200 050 06					50	1.94	6	•	A5R 0200 050 06				10	50	1.94	6	•
A5Q 0250 050 04	2.5	1.25	2.5		50	2.4	4	•	A5R 0250 050 04	2.5	1.25	2.5	7.5	50	2.4	4	◦
A5Q 0250 050 06					50	2.4	6	•	A5R 0250 050 06				12.5	50	2.4	6	◦
A5Q 0300 050 04	3	1.5	3		50	2.85	4	•	A5R 0300 050 04	3	1.5	3	9	50	2.85	4	•
A5Q 0300 050 06					50	2.85	6	•	A5R 0300 050 06				15	50	2.85	6	•
A5Q 0400 050 04	4	2	4		50	3.8	4	•	A5R 0400 050 04	4	2	4	12	50	3.8	4	◦
A5Q 0400 060 06					60	3.8	6	•	A5R 0400 060 06				20	60	3.8	6	•
A5Q 0500 060 06	5	2.5	5		60	4.8	6	•	A5R 0500 060 06	5	2.5	5	20	60	4.8	6	•
A5Q 0600 060					60	5.8	6	•	A5R 0600 060				24	60	5.8	6	•
A5Q 0600 075	6	3	6		75	5.8	6	•	A5R 0600 075	6	3	6	24	75	5.8	6	•
A5Q 0600 100					100	2.8	6	•	A5R 0600 100				24	100	2.8	6	•
A5Q 0800 075	8	4	8		75	7.8	8	•	A5R 0800 075	8	4	8	24	75	7.8	8	•
A5Q 0800 100					100	1.8	8	•	A5R 0800 100				24	100	1.8	8	•
A5Q 1000 075	10	5	10		75	9.8	10	•	A5R 1000 075	10	5	10	30	75	9.8	10	•
A5Q 1000 100					100	9.8	10	•	A5R 1000 100				30	100	9.8	10	•
A5Q 1000 125					125	9.8	10	◦	A5R 1000 125				30	125	9.8	10	•
A5Q 1000 150					150	9.8	10	◦	A5R 1000 150				30	150	9.8	10	◦
A5Q 1200 075	12	6	12		75	11.7	12	•	A5R 1200 075	12	6	12	36	75	11.7	12	•
A5Q 1200 100					100	11.7	12	•	A5R 1200 100				36	100	11.7	12	•
A5Q 1200 150					150	11.7	12	◦	A5R 1200 150				36	150	11.7	12	◦

BN 30
BN 45
BN 60
BN 60X
DM70 - BN70
BN GR

Diameter (mm)	Tolerance
R ≤ 2.5	±0.005
2.5 ≤ D ≤ 6	±0.010
6 < R	±0.015

Material Group | Material-Gruppe | Groupe Matière | Gruppo Materiali | 材质主类

Cutting Parameter

N01	N02	N03	K01	K02	P01	P02	P03	M01	M02	S01	S02	S03	H01	H02	O01	O02	430
-----	-----	-----	-----	-----	-----	-----	-----	-----	-----	-----	-----	-----	-----	-----	-----	-----	-----

FEATURES & BENEFITS

DM70 (BN 70)



Top View

1 Enhanced Chisel Angle Design

- Further enhanced surface finishing of machining component
- Increases endface wear resistance and tool life
- More reliable to machine high accuracy components
- Perfect for Semi-Finishing and Finishing operations

2 Enhanced Tool Rigidity

- Higher stability to reduce vibration
- Enhanced tool life and productivity
- Higher process reliability and dimension accuracy

3 Suitable for Material

H





1. verbesserter Schneidwinkel
verbesserte Oberflächengüte des Bauteils
Erhebliche Erhöhung der Verschleißfestigkeit, der Stirnfläche und der Werkzeugstandzeit
Zuverlässiger bei der Bearbeitung moderner, hochpräziser Komponenten
Perfekt für Semi-Schlichten und Schlichten.
2. verbesserte Werkzeugstabilität
höhere Stabilität zur Reduzierung von Vibrationen
verbesserte Werkzeugstandzeit und Produktivität der Werkzeuge
höhere Prozesssicherheit und Maßgenauigkeit
3. Geeignet für Materialgruppe H



1. 增强型凿角设计
进一步提高加工部件的表面光洁度
可有效提高端面耐磨性和延长刀具寿命
加工先进高精度工件更具可靠性
非常适用于半精加工和精加工的操作
2. 增强刀具的刚性
具有更高的稳定性可减少震动
延长刀具寿命和提高其生产率性能
提高加工过程的可靠性和刀具尺寸的精确度
3. 适用于加工材料H



1. Design migliorato dell'angolo del tagliente in testa
Ulteriore miglioramento della finitura superficiale del componente di lavorazione
Aumenta la resistenza all'usura delle estremità e la durata dell'utensile
Affidabile per le lavorazioni di alta precisione
Ideale per le operazioni di semifinitura e finitura
2. Maggiore rigidità dell'utensile
Maggiore stabilità e vibrazioni ridotte
Migliora la durata dell'utensile e la produttività
Migliore precisione dimensionale
3. Adatto per il materiale H



1. Conception d'angle de ciseau amélioré
Finition de surface encore améliorée du composant d'usinage
Augmente considérablement la résistance à l'usure et la durée de vie de l'outil
Plus fiable pour usiner des composants modernes de haute précision
Parfait pour les opérations de semi-finition et de finition
2. Rigidité de l'outil améliorée
Une plus grande stabilité pour réduire les vibrations et Améliorez la durée de vie de l'outil et les performances de productivité
Fiabilité de processus plus élevée et précision des dimensions plus élevée
3. Adapté aux matériaux H

BN 70 MINIATURE BALLNOSE CUTTERS WITH LONG NECK, 2 FLUTES

- VHM BN 70 Kleinstradiusfräser mit langem Hals, 2 Zähne
- Micro-frese sferiche BN 70, con collo lungo, 2 taglienti
- Micro-fraises BN 70 à bout hémisphérique avec cou long, 2 dents
- 整体硬质合金 BN 70 系列 微小径2刃长颈球头铣刀

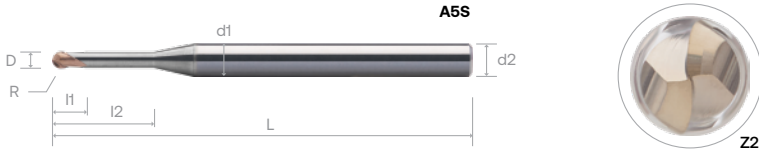

Order Number	Dimension (mm)							B0909+	Order Number	Dimension (mm)							B0909+
	D	R	I1	I2	L	d1	d2(h6)			D	R	I1	I2	L	d1	d2(h6)	
A5S 0010 050 0400	0.1	0.05	0.07	-	50	-	4	o	A5S 0050 050 0400 0300	0.5	0.25	0.35	3	50	0.46	4	o
A5S 0010 050 0400 0020				0.2	50	0.085	4	o	A5S 0050 050 0400 0350				3.5	50	0.46	4	o
A5S 0010 050 0400 0030				0.3	50	0.085	4	o	A5S 0050 050 0400 0400				4	50	0.46	4	o
A5S 0010 050 0400 0050	0.15	0.075	0.10	0.5	50	0.085	4	o	A5S 0050 050 0400 0450	0.6	0.3	0.45	4.5	50	0.46	4	o
A5S 0015 050 0400				-	50	-	4	o	A5S 0050 050 0400 0500				5	50	0.46	4	o
A5S 0015 050 0400 0030				0.3	50	0.13	4	o	A5S 0050 050 0400 0550				5.5	50	0.46	4	o
A5S 0015 050 0400 0050	0.2	0.1	0.15	0.5	50	0.13	4	o	A5S 0050 050 0400 0600	0.7	0.35	0.50	6	50	0.46	4	o
A5S 0015 050 0400 0100				1	50	0.13	4	o	A5S 0050 050 0400 0800				8	50	0.46	4	o
A5S 0020 050 0400				-	50	-	4	o	A5S 0050 050 0400 1000				10	50	0.46	4	o
A5S 0020 050 0400 0030	0.3	0.15	0.20	0.3	50	0.18	4	o	A5S 0060 050 0400	0.8	0.4	0.60	-	50	-	4	o
A5S 0020 050 0400 0050				0.5	50	0.18	4	o	A5S 0060 050 0400 0100				1	50	0.56	4	o
A5S 0020 050 0400 0075				0.75	50	0.18	4	o	A5S 0060 050 0400 0150				1.5	50	0.56	4	o
A5S 0020 050 0400 0100	0.4	0.2	0.30	1	50	0.18	4	o	A5S 0060 050 0400 0200	0.9	0.45	0.65	2	50	0.56	4	o
A5S 0020 050 0400 0125				1.25	50	0.18	4	o	A5S 0060 050 0400 0250				2.5	50	0.56	4	o
A5S 0020 050 0400 0150				1.5	50	0.18	4	o	A5S 0060 050 0400 0300				3	50	0.56	4	o
A5S 0020 050 0400 0175	0.5	0.25	0.35	1.75	50	0.18	4	o	A5S 0060 050 0400 0350	1	0.5	0.75	3.5	50	0.56	4	o
A5S 0020 050 0400 0200				2	50	0.18	4	o	A5S 0060 050 0400 0400				4	50	0.56	4	o
A5S 0020 050 0400 0250				2.5	50	0.18	4	o	A5S 0060 050 0400 0450				4.5	50	0.56	4	o
A5S 0020 050 0400 0300	0.6	0.3	0.45	3	50	0.18	4	o	A5S 0060 050 0400 0500	1.1	0.55	0.85	5	50	0.56	4	o
A5S 0020 050 0600				-	50	-	6	o	A5S 0060 050 0400 0550				5.5	50	0.56	4	o
A5S 0020 050 0600 0100				1	50	0.18	6	o	A5S 0060 050 0400 0600				6	50	0.56	4	o
A5S 0030 050 0400	0.7	0.35	0.50	-	50	-	4	o	A5S 0060 050 0400 0700	1.2	0.6	0.90	7	50	0.56	4	o
A5S 0030 050 0400 0050				0.5	50	0.28	4	o	A5S 0060 050 0400 0800				8	50	0.56	4	o
A5S 0030 050 0400 0060				0.6	50	0.28	4	o	A5S 0060 050 0400 0900				9	50	0.56	4	o
A5S 0030 050 0400 0075	0.8	0.4	0.60	0.75	50	0.28	4	o	A5S 0060 050 0400 1000	1.3	0.65	0.95	10	50	0.56	4	o
A5S 0030 050 0400 0100				1	50	0.28	4	o	A5S 0060 050 0400 1200				12	50	0.56	4	o
A5S 0030 050 0400 0125				1.25	50	0.28	4	o	A5S 0060 050 0600				-	50	-	6	o
A5S 0030 050 0400 0150	0.9	0.45	0.65	1.5	50	0.28	4	o	A5S 0060 050 0600 0200	1.4	0.7	1.00	2	50	0.56	6	o
A5S 0030 050 0400 0175				1.75	50	0.28	4	o	A5S 0060 050 0600 0300				3	50	0.56	6	o
A5S 0030 050 0400 0200				2	50	0.28	4	o	A5S 0060 050 0600 0400				4	50	0.56	6	o
A5S 0030 050 0400 0225	1.0	0.5	0.75	2.25	50	0.28	4	o	A5S 0070 050 0400	1.5	0.75	1.10	-	50	-	4	o
A5S 0030 050 0400 0250				2.5	50	0.28	4	o	A5S 0070 050 0400 0200				2	50	0.66	4	o
A5S 0030 050 0400 0300				3	50	0.28	4	o	A5S 0070 050 0400 0400				4	50	0.66	4	o
A5S 0030 050 0400 0350	1.1	0.55	0.825	3.5	50	0.28	4	o	A5S 0070 050 0400 0600	1.6	0.8	1.20	6	50	0.66	4	o
A5S 0030 050 0400 0400				4	50	0.28	4	o	A5S 0070 050 0400 0800				8	50	0.66	4	o
A5S 0030 050 0600				-	50	-	6	o	A5S 0080 050 0400				-	50	-	4	o
A5S 0030 050 0600 0150	1.2	0.6	0.90	1.5	50	0.28	6	o	A5S 0080 050 0400 0200	1.7	0.85	1.30	2	50	0.76	4	o
A5S 0040 050 0400				-	50	-	4	o	A5S 0080 050 0400 0300				3	50	0.76	4	o
A5S 0040 050 0400 0050				0.5	50	0.37	4	o	A5S 0080 050 0400 0400				4	50	0.76	4	o
A5S 0040 050 0400 0080	1.3	0.65	0.975	0.8	50	0.37	4	o	A5S 0080 050 0400 0500	1.8	0.9	1.40	5	50	0.76	4	o
A5S 0040 050 0400 0100				1	50	0.37	4	o	A5S 0080 050 0400 0600				6	50	0.76	4	o
A5S 0040 050 0400 0150				1.5	50	0.37	4	o	A5S 0080 050 0400 0700				7	50	0.76	4	o
A5S 0040 050 0400 0200	1.4	0.7	1.05	2	50	0.37	4	o	A5S 0080 050 0400 0800	1.9	0.95	1.45	8	50	0.76	4	o
A5S 0040 050 0400 0250				2.5	50	0.37	4	o	A5S 0080 050 0400 1000				10	50	0.76	4	o
A5S 0040 050 0400 0300				3	50	0.37	4	o	A5S 0080 050 0400 1200				12	50	0.76	4	o
A5S 0040 050 0400 0350	1.5	0.75	1.125	3.5	50	0.37	4	o	A5S 0080 050 0600	2.0	1.0	1.50	-	50	-	6	o
A5S 0040 050 0400 0400				4	50	0.37	4	o	A5S 0080 050 0600 0200				2	50	0.76	6	o
A5S 0040 050 0400 0450				4.5	50	0.37	4	o	A5S 0090 050 0400				-	50	-	4	o
A5S 0040 050 0400 0500	1.6	0.8	1.20	5	50	0.37	4	o	A5S 0090 050 0400 0200	2.1	1.05	1.55	2	50	0.86	4	o
A5S 0040 050 0400 0600				6	50	0.37	4	o	A5S 0090 050 0400 0400				4	50	0.86	4	o
A5S 0040 050 0600				-	50	-	6	o	A5S 0090 050 0400 0600				6	50	0.86	4	o
A5S 0040 050 0600 0100	1.7	0.85	1.275	1	50	0.37	6	o	A5S 0090 050 0400 0800	2.2	1.1	1.60	8	50	0.86	4	o
A5S 0040 050 0600 0200				2	50	0.37	6	o	A5S 0100 050 0400				-	50	-	4	o
A5S 0050 050 0400				-	50	-	4	o	A5S 0100 050 0400 0200				2	50	0.95	4	o
A5S 0050 050 0400 0100	1.8	0.9	1.35	1	50	0.46	4	o	A5S 0100 050 0400 0250	2.3	1.15	1.65	2.5	50	0.95	4	o
A5S 0050 050 0400 0150				1.5	50	0.46	4	o	A5S 0100 050 0400 0300				3	50	0.95	4	o
A5S 0050 050 0400 0200				2	50	0.46	4	o	A5S 0100 050 0400 0400				4	50	0.95	4	o
A5S 0050 050 0400 0250	1.9	0.95	1.425	2.5	50	0.46	4	o	A5S 0100 050 0400 0500	2.4	1.2	1.70	5	50	0.95	4	o

cont'd ▶

Diameter (mm)	Radius Tolerance
R ≤ 2.5	±0.005
2.5 ≤ R ≤ 6	±0.010
6 < R	±0.015

Material Group | Material-Gruppe | Groupe Matière | Gruppo Materiali | 材质主类

Cutting Parameter

N01
N02
N03
K01
K02
P01
P02
P03
M01
M02
S01
S02
S03
H01
H02
O01
O02
430 - 434

BN 70 MINIATURE BALLNOSE CUTTERS WITH LONG NECK, 2 FLUTES

- VHM BN 70 Kleinstradiusfräser mit langem Hals, 2 Zähne
- Micro-frese sferiche BN 70, con collo lungo, 2 taglianti
- Micro-fraises BN 70 à bout hémisphérique avec cou long, 2 dents
- 整体硬质合金 BN 70 系列 微小径2刃长颈球头铣刀

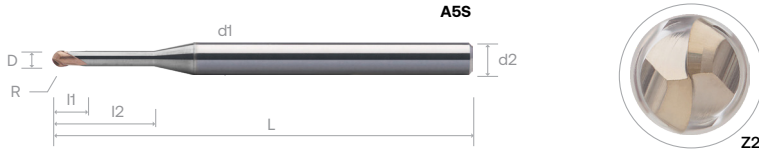

Order Number	Dimension (mm)							B0909+	Order Number	Dimension (mm)							B0909+
	D	R	I1	I2	L	d1	d2(h6)			D	R	I1	I2	L	d1	d2(h6)	
A5S 0100 050 0400 0600	1	0.5	0.75	6	50	0.95	4	•	A5S 0200 050 0400	2	1	150	-	50	-	4	◦
A5S 0100 050 0400 0700				7	50	0.95	4	◦	A5S 0200 050 0400 0300				3	50	1.94	4	◦
A5S 0100 050 0400 0800				8	50	0.95	4	•	A5S 0200 050 0400 0400				4	50	1.94	4	◦
A5S 0100 050 0400 0900				9	50	0.95	4	◦	A5S 0200 050 0400 0600				6	50	1.94	4	•
A5S 0100 050 0400 1000				10	50	0.95	4	•	A5S 0200 050 0400 0800				8	50	1.94	4	•
A5S 0100 050 0400 1200				12	50	0.95	4	◦	A5S 0200 050 0400 1000				10	50	1.94	4	•
A5S 0100 050 0400 1300				13	50	0.95	4	◦	A5S 0200 050 0400 1200				12	50	1.94	4	•
A5S 0100 050 0400 1400				14	50	0.95	4	◦	A5S 0200 050 0400 1300				13	50	1.94	4	◦
A5S 0100 050 0400 1600				16	50	0.95	4	◦	A5S 0200 050 0400 1400				14	50	1.94	4	◦
A5S 0100 050 0400 1800				18	60	0.95	4	◦	A5S 0200 050 0400 1600				16	50	1.94	4	•
A5S 0100 050 0600				-	50	0.95	6	◦	A5S 0200 060 0400				-	60	-	4	◦
A5S 0100 050 0600 0300				3	50	0.95	6	◦	A5S 0200 060 0400 1800				18	60	1.94	4	◦
A5S 0100 050 0600 0400				4	50	0.95	6	◦	A5S 0200 060 0400 2000				20	60	1.94	4	◦
A5S 0100 050 0600 0500				5	50	0.95	6	◦	A5S 0200 060 0400 2200				22	60	1.94	4	◦
A5S 0100 050 0600 0600				6	50	0.95	6	◦	A5S 0200 075 0400				-	75	-	4	◦
A5S 0100 050 0600 0700				7	50	0.95	6	◦	A5S 0200 075 0400 2500				25	75	1.94	4	◦
A5S 0100 050 0600 0800				8	50	0.95	6	◦	A5S 0200 075 0400 3000				30	75	1.94	4	◦
A5S 0100 050 0600 1000				10	50	0.95	6	◦	A5S 0200 075 0400 3500				35	75	1.94	4	◦
A5S 0100 060 0400				-	60	-	4	◦	A5S 0200 075 0400 4000				40	75	1.94	4	◦
A5S 0100 060 0400 2000				20	60	0.95	4	◦	A5S 0200 050 0600				-	50	-	6	◦
A5S 0100 060 0600	-	60	-	6	◦	A5S 0200 050 0600 0400	4	50	1.94	6	◦						
A5S 0100 060 0600 2200	22	60	0.95	6	◦	A5S 0200 050 0600 0600	6	50	1.94	6	◦						
A5S 0120 050 0400	-	50	-	4	◦	A5S 0200 050 0600 0800	8	50	1.94	6	◦						
A5S 0120 050 0400 0240	1.2	0.6	0.90	2.4	50	1.15	4	◦	A5S 0200 050 0600 1000	10	50	1.94	6	◦			
A5S 0120 050 0400 0400				4	50	1.15	4	◦	A5S 0200 060 0600	-	60	-	6	◦			
A5S 0120 050 0400 0600				6	50	1.15	4	◦	A5S 0200 060 0600 1600	16	60	1.94	6	◦			
A5S 0120 050 0400 0800				8	50	1.15	4	◦	A5S 0200 075 0600	-	75	-	6	◦			
A5S 0120 050 0400 1000				10	50	1.15	4	◦	A5S 0200 075 0600 2500	25	75	1.94	6	◦			
A5S 0120 050 0400 1200				12	50	1.15	4	◦	A5S 0250 050 0400	-	50	-	4	◦			
A5S 0120 050 0400 1400				14	50	1.15	4	◦	A5S 0250 050 0400 0600	6	50	2.4	4	◦			
A5S 0120 050 0400 1600				16	50	1.15	4	◦	A5S 0250 050 0400 0800	8	50	2.4	4	◦			
A5S 0140 050 0400				-	50	-	4	◦	A5S 0250 050 0400 1000	10	50	2.4	4	◦			
A5S 0140 050 0400 0800				1.4	0.7	1.00	8	50	1.35	4	◦	A5S 0250 050 0400 1500	15	50	2.4	4	◦
A5S 0140 050 0400 1200	12	50	1.35				4	◦	A5S 0250 060 0400	-	60	-	4	◦			
A5S 0140 050 0400 1600	16	50	1.35				4	◦	A5S 0250 060 0400 2000	20	60	2.4	4	◦			
A5S 0150 050 0400	-	50	-	4	◦	A5S 0250 075 0400	-	75	-	4	◦						
A5S 0150 050 0400 0300	1.5	0.75	1.10	3	50	1.45	4	◦	A5S 0250 075 0400 2500	25	75	2.4	4	◦			
A5S 0150 050 0400 0400				4	50	1.45	4	◦	A5S 0250 075 0400 3000	30	75	2.4	4	◦			
A5S 0150 050 0400 0600				6	50	1.45	4	◦	A5S 0250 075 0400 3500	35	75	2.4	4	◦			
A5S 0150 050 0400 0800				8	50	1.45	4	•	A5S 0300 060 0600	-	60	-	6	◦			
A5S 0150 050 0400 1000				10	50	1.45	4	•	A5S 0300 060 0600 0600	6	60	2.85	6	•			
A5S 0150 050 0400 1200				12	50	1.45	4	◦	A5S 0300 060 0600 0800	8	60	2.85	6	◦			
A5S 0150 050 0400 1400				14	50	1.45	4	◦	A5S 0300 060 0600 1000	10	60	2.85	6	•			
A5S 0150 050 0400 1600				16	50	1.45	4	◦	A5S 0300 060 0600 1200	12	60	2.85	6	•			
A5S 0150 060 0400				-	60	-	4	◦	A5S 0300 060 0600 1400	14	60	2.85	6	◦			
A5S 0150 060 0400 2000				20	60	1.45	4	◦	A5S 0300 060 0600 1600	16	60	2.85	6	•			
A5S 0150 060 0400 2200				22	60	1.45	4	◦	A5S 0300 060 0600 2000	20	60	2.85	6	•			
A5S 0150 075 0400				-	75	-	4	◦	A5S 0300 075 0600	-	75	-	6	◦			
A5S 0150 075 0400 3000				30	75	1.45	4	◦	A5S 0300 075 0600 2500	25	75	2.85	6	•			
A5S 0150 050 0600				-	50	-	6	◦	A5S 0300 075 0600 3000	30	75	2.85	6	◦			
A5S 0150 050 0600 0600				6	50	1.45	6	◦	A5S 0300 075 0600 3500	35	75	2.85	6	◦			
A5S 0150 050 0600 0800				8	50	1.45	6	◦	A5S 0300 100 0600	-	100	-	6	◦			
A5S 0160 050 0400				-	50	-	4	◦	A5S 0300 100 0600 4000	40	100	2.85	6	◦			
A5S 0160 050 0400 0800				8	50	1.55	4	◦	A5S 0350 060 0600	-	60	-	6	◦			
A5S 0160 050 0400 1200				12	50	1.55	4	◦	A5S 0350 060 0600 1500	15	60	3.35	6	◦			
A5S 0160 050 0400 1600				16	50	1.55	4	◦	A5S 0350 060 0600 2000	20	60	3.35	6	◦			
A5S 0160 060 0400	-	60	-	4	◦	A5S 0350 075 0600	-	75	-	6	◦						
A5S 0160 060 0400 2000	20	60	1.55	4	◦	A5S 0350 075 0600 2500	25	75	3.35	6	◦						

cont'd ▶

Diameter (mm)	Radius Tolerance
R ≤ 2.5	±0.005
2.5 ≤ R ≤ 6	±0.010
6 < R	±0.015

Material Group | Material-Gruppe | Groupe Matière | Gruppo Materiali | 材质主类

Cutting Parameter

N01
N02
N03
K01
K02
P01
P02
P03
M01
M02
S01
S02
S03
H01
H02
O01
O02
430 - 434

BN 70 MINIATURE BALLNOSE CUTTERS WITH LONG NECK, 2 FLUTES

- VHM BN 70 Kleinstradiusfräser mit langem Hals, 2 Zähne
- Micro-frese sferiche BN 70, con collo lungo, 2 taglienti
- Micro-fraises BN 70 à bout hémisphérique avec cou long, 2 dents
- 整体硬质合金 BN 70 系列 微小径2刃长颈球头铣刀

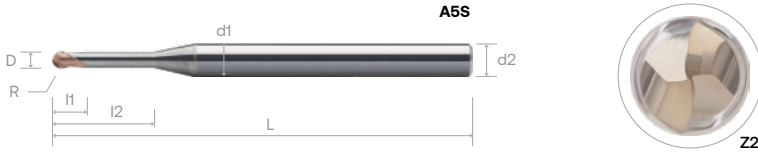

Order Number	Dimension (mm)							B0909+	Order Number	Dimension (mm)							B0909+					
	D	R	I1	I2	L	d1	d2(h6)			D	R	I1	I2	L	d1	d2(h6)						
A5S 0350 075 0600 3000	3.5	1.75	2.80	30	75	3.35	6	°														
A5S 0350 075 0600 3500				35	75	3.35	6	°														
A5S 0350 100 0600				-	100	-	6	°														
A5S 0350 100 0600 4000				40	100	3.35	6	°														
A5S 0350 100 0600 4500	45	100	3.35	6	°																	
A5S 0400 060 0400	4	2	3.00	-	60	-	4	°														
A5S 0400 060 0400 0800				8	60	3.8	4	°														
A5S 0400 060 0600				-	60	-	6	°														
A5S 0400 060 0600 0800				8	60	3.8	6	°														
A5S 0400 060 0600 1000				10	60	3.8	6	°														
A5S 0400 060 0600 1200				12	60	3.8	6	°														
A5S 0400 060 0600 1400				14	60	3.8	6	°														
A5S 0400 060 0600 1600				16	60	3.8	6	°														
A5S 0400 060 0600 2000				20	60	3.8	6	°														
A5S 0400 075 0600				-	75	-	6	°														
A5S 0400 075 0600 2500				25	75	3.8	6	°														
A5S 0400 075 0600 3000				30	75	3.8	6	°														
A5S 0400 075 0600 3500	35	75	3.8	6	°																	
A5S 0400 100 0600	-	100	-	6	°																	
A5S 0400 100 0600 4000	40	100	3.8	6	°																	
A5S 0400 100 0600 4500	45	100	3.8	6	°																	
A5S 0400 100 0600 5000	50	100	3.8	6	°																	
A5S 0500 060 0600	5	2.5	3.50	-	60	-	6	°														
A5S 0500 060 0600 1000				10	60	4.8	6	°														
A5S 0500 060 0600 1500				15	60	4.8	6	°														
A5S 0500 060 0600 2000				20	60	4.8	6	°														
A5S 0500 075 0600				-	75	-	6	°														
A5S 0500 075 0600 2500				25	75	4.8	6	°														
A5S 0500 075 0600 3000				30	75	4.8	6	°														
A5S 0500 100 0600				-	100	-	6	°														
A5S 0500 100 0600 4000				40	100	4.8	6	°														
A5S 0600 060 0600				6	3	6.00	-	60	-	6	°											
A5S 0600 060 0600 1000							10	60	5.7	6	°											
A5S 0600 060 0600 1500							15	60	5.7	6	°											
A5S 0600 060 0600 2000	20	60	5.7				6	°														
A5S 0600 075 0600	-	75	-				6	°														
A5S 0600 075 0600 2500	25	75	5.7				6	°														
A5S 0600 075 0600 3000	30	75	5.7				6	°														
A5S 0600 075 0600 3500	35	75	5.7				6	°														
A5S 0600 100 0600	-	100	-				6	°														
A5S 0600 100 0600 4000	40	100	5.7				6	°														
A5S 0600 100 0600 5000	50	100	5.7				6	°														
A5S 0600 120 0600	-	120	-				6	°														
A5S 0600 120 0600 6000	60	120	5.7	6	°																	

Diameter (mm)	Radius Tolerance
R ≤ 2.5	±0.005
2.5 ≤ R ≤ 6	±0.010
6 < R	±0.015

Material Group | Material-Gruppe | Groupe Matière | Gruppo Materiali | 材质主类

Cutting Parameter

N01	N02	N03	K01	K02	P01	P02	P03	M01	M02	S01	S02	S03	H01	H02	O01	O02	430 - 434
-----	-----	-----	-----	-----	-----	-----	-----	-----	-----	-----	-----	-----	-----	-----	-----	-----	-----------

Recommended Cutting Data



Note: These recommended cutting data indicators are just for reference. They should be adjusted according to the different cutting condition



BN 70 Ballnose Cutters, 2 Flutes - A5Q, A5R

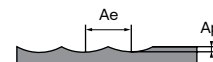

Roughing		H					
Working Material		Hardened Steel		Hardened Steel		Hardened Steel	
Properties		50 ≤ HRC ≤ 55		55 < HRC ≤ 65		65 < HRC ≤ 70	
Cutting depth, ap		0.05 - 0.10		0.05 - 0.10		0.05 - 0.10	
Cutting Width, ae		0.02 x D		0.02 x D		0.02 x D	
D	Vc	Fz	Vc	Fz	Vc	Fz	
1	260	0.028	220	0.024	165	0.015	
2		0.035		0.037		0.036	
3		0.061		0.061		0.061	
4		0.085		0.076		0.076	
5		0.097		0.087		0.090	
6		0.106		0.101		0.101	
8		0.116		0.095		0.111	
10		0.126		0.116		0.121	
12		0.132		0.128		0.126	

BN 70 Miniature Ballnose Cutters With Long Neck, 2 Flute - A5S

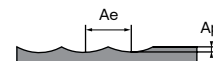

Profiling		H							
Working Material		Hardened steel				Hardened steel			
Properties		45 ≤ HRC < 52				52 ≤ HRC < 68			
D	Effective Length	Ap	Ae	N	Fz	Ap	Ae	N	Fz
0.1	-	0.003	0.005	40,000	0.003	0.002	0.005	40,000	0.001
	0.2	0.003	0.005	40,000	0.002	0.002	0.005	40,000	0.001
	0.3	0.003	0.005	40,000	0.002	0.002	0.005	40,000	0.001
	0.5	0.002	0.005	40,000	0.001	0.001	0.005	40,000	0.001
0.15	-	0.003	0.008	40,000	0.003	0.002	0.008	40,000	0.002
	0.3	0.003	0.008	40,000	0.002	0.002	0.008	40,000	0.001
	0.5	0.003	0.008	40,000	0.002	0.002	0.008	40,000	0.001
	1	0.002	0.008	40,000	0.001	0.001	0.008	40,000	0.000
0.2	-	0.010	0.010	40,000	0.005	0.003	0.010	40,000	0.003
	0.3	0.010	0.010	40,000	0.004	0.003	0.010	40,000	0.003
	0.5	0.008	0.010	40,000	0.004	0.003	0.010	40,000	0.002
	0.75	0.005	0.010	40,000	0.004	0.002	0.010	40,000	0.002
	1	0.003	0.010	40,000	0.003	0.001	0.010	40,000	0.002
	1.25	0.003	0.010	40,000	0.003	0.001	0.010	40,000	0.002
	1.5	0.003	0.010	40,000	0.003	0.001	0.010	40,000	0.002
	1.75	0.002	0.010	40,000	0.002	0.001	0.010	40,000	0.001
	2	0.002	0.010	40,000	0.002	0.001	0.010	40,000	0.001
	2.5	0.001	0.010	40,000	0.001	0.001	0.010	40,000	0.001
0.3	3	0.001	0.010	40,000	0.001	0.001	0.010	40,000	0.000
	-	0.010	0.015	40,000	0.005	0.003	0.015	40,000	0.004
	0.5	0.010	0.015	40,000	0.004	0.003	0.015	40,000	0.004
	0.6	0.007	0.015	40,000	0.004	0.003	0.015	40,000	0.003
	0.75	0.007	0.015	40,000	0.004	0.003	0.015	40,000	0.003
	1	0.007	0.015	40,000	0.004	0.003	0.015	40,000	0.003
	1.25	0.005	0.015	40,000	0.004	0.002	0.015	40,000	0.003
	1.5	0.005	0.015	40,000	0.003	0.002	0.015	40,000	0.003
	1.75	0.003	0.015	40,000	0.003	0.002	0.015	40,000	0.002
	2	0.003	0.015	40,000	0.003	0.002	0.015	40,000	0.002
	2.25	0.002	0.015	40,000	0.003	0.001	0.015	40,000	0.002
	2.5	0.002	0.015	40,000	0.002	0.001	0.015	40,000	0.002
3	0.001	0.015	40,000	0.002	0.001	0.015	40,000	0.001	
3.5	0.001	0.015	40,000	0.001	0.001	0.015	40,000	0.001	
4	0.001	0.015	40,000	0.001	0.001	0.015	40,000	0.001	

cont'd ▶

BN 30
BN 45
BN 60
BN 60X
BN 70 - DM70
BN GR

Recommended Cutting Data



Note: These recommended cutting data indicators are just for reference. They should be adjusted according to the different cutting condition



BN 70 Miniature Ballnose Cutters With Long Neck, 2 Flute - A5S

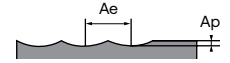

Profiling		H							
Working Material		Hardened steel				Hardened steel			
Properties		45 ≤ HRC < 52				52 ≤ HRC < 68			
D	Effective Length	Ap	Ae	N	Fz	Ap	Ae	N	Fz
0.4	-	0.030	0.020	40,000	0.011	0.009	0.020	40,000	0.008
	0.5	0.030	0.020	40,000	0.010	0.009	0.020	40,000	0.007
	0.8	0.020	0.020	40,000	0.009	0.008	0.020	40,000	0.007
	1	0.020	0.020	40,000	0.009	0.008	0.020	40,000	0.007
	1.5	0.010	0.020	40,000	0.008	0.005	0.020	40,000	0.006
	2	0.010	0.020	40,000	0.007	0.005	0.020	40,000	0.005
	2.5	0.007	0.020	40,000	0.007	0.003	0.020	40,000	0.005
	3	0.007	0.020	40,000	0.006	0.003	0.020	40,000	0.004
	3.5	0.005	0.020	40,000	0.005	0.002	0.020	40,000	0.004
	4	0.005	0.020	30,000	0.005	0.002	0.020	30,000	0.004
	4.5	0.003	0.020	30,000	0.004	0.001	0.020	30,000	0.003
	5	0.002	0.020	30,000	0.003	0.001	0.020	30,000	0.002
0.5	6	0.001	0.020	30,000	0.001	0.001	0.020	30,000	0.001
	-	0.030	0.025	40,000	0.014	0.010	0.025	40,000	0.009
	1	0.030	0.025	40,000	0.013	0.010	0.025	40,000	0.008
	1.5	0.020	0.025	40,000	0.012	0.007	0.025	40,000	0.008
	2	0.020	0.025	40,000	0.011	0.007	0.025	40,000	0.007
	2.5	0.010	0.025	40,000	0.011	0.005	0.025	40,000	0.007
	3	0.010	0.025	40,000	0.010	0.005	0.025	40,000	0.006
	3.5	0.007	0.025	40,000	0.009	0.003	0.025	40,000	0.006
	4	0.007	0.025	40,000	0.009	0.003	0.025	40,000	0.006
	4.5	0.005	0.025	40,000	0.008	0.002	0.025	40,000	0.005
	5	0.005	0.025	33,000	0.009	0.002	0.025	33,000	0.006
	5.5	0.003	0.025	30,000	0.009	0.001	0.025	30,000	0.006
0.6	6	0.002	0.025	30,000	0.008	0.001	0.025	30,000	0.005
	8	0.002	0.025	30,000	0.004	0.001	0.025	30,000	0.003
	10	0.001	0.025	20,000	0.001	0.001	0.025	20,000	0.001
	-	0.050	0.030	40,000	0.019	0.020	0.030	30,000	0.013
	1	0.050	0.030	40,000	0.018	0.020	0.030	30,000	0.012
	1.5	0.050	0.030	40,000	0.017	0.020	0.030	30,000	0.011
	2	0.050	0.030	40,000	0.016	0.020	0.030	30,000	0.011
	2.5	0.030	0.030	40,000	0.015	0.020	0.030	30,000	0.010
	3	0.030	0.030	40,000	0.015	0.020	0.030	30,000	0.010
	3.5	0.020	0.030	40,000	0.014	0.010	0.030	30,000	0.009
	4	0.020	0.030	40,000	0.013	0.010	0.030	30,000	0.009
	4.5	0.020	0.030	35,000	0.014	0.008	0.030	30,000	0.008
5	0.010	0.030	30,000	0.015	0.007	0.030	30,000	0.008	
5.5	0.010	0.030	30,000	0.014	0.005	0.030	30,000	0.007	
6	0.007	0.030	30,000	0.013	0.004	0.030	30,000	0.007	
7	0.005	0.030	25,000	0.014	0.003	0.030	20,000	0.009	
8	0.003	0.030	25,000	0.011	0.002	0.030	20,000	0.007	
9	0.003	0.030	25,000	0.009	0.001	0.030	20,000	0.006	
10	0.002	0.030	20,000	0.008	0.001	0.030	18,000	0.005	
12	0.002	0.030	20,000	0.002	0.001	0.030	18,000	0.001	
0.7	-	0.070	0.035	40,000	0.025	0.030	0.035	30,000	0.021
	2	0.070	0.035	40,000	0.020	0.030	0.035	30,000	0.017
	4	0.040	0.035	40,000	0.016	0.015	0.035	30,000	0.013
	6	0.010	0.035	30,000	0.015	0.006	0.035	25,000	0.010
	8	0.006	0.035	25,000	0.010	0.004	0.035	20,000	0.006
0.8	-	0.100	0.040	40,000	0.029	0.050	0.040	30,000	0.023
	2	0.100	0.040	40,000	0.025	0.050	0.040	30,000	0.020
	3	0.100	0.040	40,000	0.023	0.050	0.040	30,000	0.018
	4	0.050	0.040	40,000	0.021	0.030	0.040	30,000	0.017
	5	0.050	0.040	40,000	0.019	0.020	0.040	30,000	0.015

cont'd ▶

BN 30
 BN 45
 BN 60
 BN 60X
 DM70 - BN70
 BN GR

Note: These recommended cutting data indicators are just for reference. They should be adjusted according to the different cutting condition



BN 70 Miniature Ballnose Cutters With Long Neck, 2 Flute - A5S

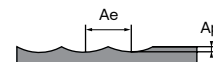

Profiling		H							
Working Material		Hardened steel				Hardened steel			
Properties		45 ≤ HRC < 52				52 ≤ HRC < 68			
D	Effective Length	Ap	Ae	N	Fz	Ap	Ae	N	Fz
0.8	6	0.030	0.040	30,000	0.022	0.010	0.040	25,000	0.016
	7	0.020	0.040	30,000	0.019	0.007	0.040	25,000	0.014
	8	0.010	0.040	30,000	0.017	0.005	0.040	25,000	0.012
	10	0.005	0.040	25,000	0.013	0.002	0.040	20,000	0.010
	12	0.003	0.040	20,000	0.008	0.002	0.040	20,000	0.005
0.9	-	0.100	0.045	40,000	0.033	0.060	0.045	30,000	0.023
	2	0.100	0.045	40,000	0.028	0.060	0.045	30,000	0.022
	4	0.050	0.045	40,000	0.023	0.030	0.045	25,000	0.024
	6	0.035	0.045	30,000	0.023	0.015	0.045	20,000	0.028
	8	0.025	0.045	30,000	0.017	0.008	0.045	20,000	0.025
1	-	0.100	0.050	40,000	0.034	0.080	0.050	25,000	0.031
	2	0.100	0.050	40,000	0.031	0.080	0.050	25,000	0.028
	2.5	0.100	0.050	40,000	0.030	0.080	0.050	25,000	0.027
	3	0.100	0.050	40,000	0.030	0.080	0.050	25,000	0.027
	4	0.100	0.050	40,000	0.028	0.050	0.050	25,000	0.025
	5	0.050	0.050	30,000	0.036	0.030	0.050	20,000	0.030
	6	0.050	0.050	30,000	0.034	0.020	0.050	20,000	0.028
	7	0.040	0.050	30,000	0.031	0.020	0.050	20,000	0.026
	8	0.040	0.050	30,000	0.029	0.020	0.050	20,000	0.025
	9	0.030	0.050	25,000	0.033	0.010	0.050	18,000	0.026
	10	0.030	0.050	25,000	0.030	0.010	0.050	18,000	0.024
	12	0.010	0.050	20,000	0.032	0.005	0.050	16,000	0.022
	13	0.008	0.050	20,000	0.029	0.003	0.050	16,000	0.020
	14	0.005	0.050	20,000	0.026	0.002	0.050	16,000	0.018
	16	0.005	0.050	18,000	0.022	0.002	0.050	14,000	0.016
1.2	18	0.003	0.050	18,000	0.015	0.002	0.050	14,000	0.011
	20	0.003	0.050	16,000	0.009	0.002	0.050	12,000	0.007
	22	0.002	0.050	14,000	0.002	0.001	0.050	10,000	0.002
	-	0.100	0.060	30,000	0.048	0.050	0.060	25,000	0.037
	2.4	0.100	0.060	30,000	0.042	0.050	0.060	25,000	0.032
	4	0.100	0.060	30,000	0.037	0.050	0.060	25,000	0.029
	6	0.070	0.060	30,000	0.032	0.030	0.060	20,000	0.030
	8	0.050	0.060	30,000	0.027	0.020	0.060	20,000	0.025
1.4	10	0.030	0.060	20,000	0.032	0.010	0.060	18,000	0.022
	12	0.020	0.060	20,000	0.025	0.007	0.060	18,000	0.016
	14	0.020	0.060	18,000	0.019	0.005	0.060	16,000	0.011
	16	0.010	0.060	16,000	0.011	0.003	0.060	14,000	0.005
	-	0.120	0.070	30,000	0.059	0.030	0.070	20,000	0.039
	8	0.120	0.070	30,000	0.042	0.030	0.070	20,000	0.025
	12	0.070	0.070	20,000	0.044	0.015	0.070	18,000	0.020
1.5	16	0.020	0.070	17,000	0.030	0.008	0.070	16,000	0.014
	-	0.150	0.075	30,000	0.055	0.100	0.075	25,000	0.044
	3	0.150	0.075	30,000	0.050	0.100	0.075	25,000	0.040
	4	0.150	0.075	30,000	0.048	0.100	0.075	25,000	0.039
	6	0.150	0.075	30,000	0.045	0.100	0.075	25,000	0.036
	8	0.100	0.075	25,000	0.049	0.050	0.075	20,000	0.041
	10	0.100	0.075	25,000	0.045	0.050	0.075	20,000	0.037
	12	0.050	0.075	20,000	0.051	0.020	0.075	18,000	0.037
	14	0.050	0.075	20,000	0.045	0.020	0.075	18,000	0.033
	16	0.030	0.075	18,000	0.044	0.010	0.075	16,000	0.033
	20	0.010	0.075	16,000	0.036	0.007	0.075	14,000	0.027
22	0.010	0.075	14,000	0.034	0.007	0.075	12,000	0.026	
30	0.005	0.075	10,000	0.004	0.003	0.075	8,000	0.003	

cont'd ▶

BN 30
BN 45
BN 60
BN 60X
DM70 -
BN70
BN GR

Recommended Cutting Data



Note: These recommended cutting data indicators are just for reference. They should be adjusted according to the different cutting condition



BN 70 Miniature Ballnose Cutters With Long Neck, 2 Flute - A5S

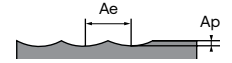

Profiling		H							
Working Material		Hardened steel				Hardened steel			
Properties		45 ≤ HRC < 52				52 ≤ HRC < 68			
D	Effective Length	Ap	Ae	N	Fz	Ap	Ae	N	Fz
1.6	-	0.100	0.080	25,000	0.077	0.050	0.080	18,000	0.069
	8	0.100	0.080	25,000	0.050	0.050	0.080	18,000	0.044
	12	0.070	0.080	20,000	0.045	0.030	0.080	14,000	0.042
	16	0.030	0.080	16,000	0.023	0.015	0.080	12,000	0.031
	20	0.010	0.080	14,000	0.018	0.010	0.080	10,000	0.015
2	-	0.200	0.100	25,000	0.065	0.150	0.100	20,000	0.054
	3	0.200	0.100	25,000	0.060	0.150	0.100	20,000	0.050
	4	0.200	0.100	25,000	0.058	0.150	0.100	20,000	0.049
	6	0.200	0.100	25,000	0.055	0.150	0.100	20,000	0.046
	8	0.200	0.100	20,000	0.065	0.100	0.100	16,000	0.054
	10	0.100	0.100	18,000	0.068	0.100	0.100	14,000	0.058
	12	0.100	0.100	16,000	0.072	0.050	0.100	12,000	0.064
	13	0.080	0.100	16,000	0.069	0.040	0.100	12,000	0.061
	14	0.070	0.100	16,000	0.067	0.030	0.100	12,000	0.059
	16	0.070	0.100	16,000	0.062	0.030	0.100	12,000	0.055
	18	0.050	0.100	14,000	0.065	0.020	0.100	10,000	0.060
	20	0.050	0.100	14,000	0.060	0.020	0.100	10,000	0.055
	22	0.030	0.100	14,000	0.054	0.020	0.100	10,000	0.050
	25	0.030	0.100	12,000	0.053	0.010	0.100	8,500	0.049
	30	0.020	0.100	12,000	0.037	0.008	0.100	8,500	0.034
35	0.010	0.100	10,000	0.025	0.005	0.100	6,800	0.023	
40	0.005	0.100	10,000	0.005	0.002	0.100	6,800	0.004	
2.5	-	0.300	0.125	20,000	0.082	0.150	0.125	18,000	0.065
	6	0.300	0.125	20,000	0.070	0.150	0.125	18,000	0.056
	8	0.250	0.125	20,000	0.066	0.120	0.125	18,000	0.052
	10	0.200	0.125	20,000	0.062	0.100	0.125	18,000	0.049
	15	0.100	0.125	18,000	0.058	0.050	0.125	14,000	0.053
	20	0.070	0.125	16,000	0.052	0.030	0.125	10,000	0.059
	25	0.050	0.125	14,000	0.045	0.020	0.125	8,000	0.056
	30	0.030	0.125	12,000	0.036	0.010	0.125	7,000	0.044
3	-	0.200	0.150	20,000	0.086	0.200	0.150	14,000	0.082
	6	0.200	0.150	20,000	0.075	0.200	0.150	14,000	0.071
	8	0.200	0.150	20,000	0.071	0.200	0.150	14,000	0.068
	10	0.200	0.150	20,000	0.068	0.100	0.150	14,000	0.064
	12	0.200	0.150	20,000	0.064	0.100	0.150	14,000	0.060
	14	0.100	0.150	18,000	0.067	0.100	0.150	12,000	0.066
	16	0.100	0.150	18,000	0.063	0.100	0.150	12,000	0.062
	20	0.100	0.150	18,000	0.054	0.100	0.150	12,000	0.053
	25	0.100	0.150	16,000	0.049	0.050	0.150	10,000	0.051
	30	0.070	0.150	14,000	0.043	0.030	0.150	8,600	0.045
	35	0.050	0.150	12,000	0.034	0.020	0.150	7,200	0.036
	40	0.030	0.150	10,000	0.023	0.010	0.150	6,400	0.020
3.5	-	0.250	0.175	20,000	0.095	0.130	0.175	14,000	0.075
	15	0.250	0.175	20,000	0.075	0.130	0.175	14,000	0.054
	20	0.180	0.175	18,000	0.073	0.100	0.175	12,000	0.054
	25	0.120	0.175	16,000	0.070	0.060	0.175	10,000	0.055
	30	0.100	0.175	14,000	0.066	0.050	0.175	9,000	0.051
	35	0.080	0.175	13,000	0.056	0.030	0.175	7,500	0.048
	40	0.070	0.175	11,000	0.049	0.020	0.175	7,000	0.037
45	0.060	0.175	10,000	0.035	0.015	0.175	6,000	0.027	

cont'd ▶

BN 30
BN 45
BN 60
BN 60X
DM70 - BN70
BN GR

Note: These recommended cutting data indicators are just for reference. They should be adjusted according to the different cutting condition



BN 70 Miniature Ballnose Cutters With Long Neck, 2 Flute - A5S

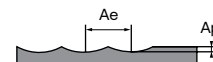

Profiling		H							
Working Material		Hardened steel				Hardened steel			
Properties		45 ≤ HRC < 52				52 ≤ HRC < 68			
D	Effective Length	Ap	Ae	N	Fz	Ap	Ae	N	Fz
4	-	0.300	0.200	20,000	0.087	0.200	0.200	12,000	0.096
	8	0.300	0.200	20,000	0.075	0.200	0.200	12,000	0.083
	10	0.300	0.200	20,000	0.072	0.200	0.200	12,000	0.080
	12	0.300	0.200	20,000	0.069	0.200	0.200	12,000	0.077
	14	0.300	0.200	20,000	0.066	0.200	0.200	12,000	0.074
	16	0.200	0.200	16,000	0.079	0.100	0.200	10,000	0.085
	20	0.200	0.200	16,000	0.072	0.100	0.200	10,000	0.077
	25	0.200	0.200	16,000	0.063	0.100	0.200	10,000	0.068
	30	0.100	0.200	14,000	0.061	0.050	0.200	8,200	0.071
	35	0.100	0.200	14,000	0.051	0.050	0.200	8,200	0.060
	40	0.070	0.200	12,000	0.047	0.030	0.200	6,800	0.059
	45	0.070	0.200	12,000	0.035	0.030	0.200	6,800	0.045
50	0.050	0.200	10,000	0.028	0.020	0.200	5,500	0.038	
5	-	0.300	0.250	18,000	0.100	0.200	0.250	9,200	0.133
	10	0.300	0.250	18,000	0.083	0.200	0.250	9,200	0.109
	15	0.300	0.250	18,000	0.075	0.200	0.250	9,200	0.096
	20	0.300	0.250	15,000	0.080	0.150	0.250	8,000	0.097
	25	0.200	0.250	15,000	0.070	0.100	0.250	7,200	0.092
	30	0.200	0.250	12,000	0.075	0.100	0.250	6,400	0.086
	40	0.100	0.250	10,000	0.060	0.050	0.250	5,500	0.059
6	-	0.300	0.300	16,000	0.109	0.200	0.300	7,000	0.167
	10	0.300	0.300	16,000	0.094	0.200	0.300	7,000	0.143
	15	0.300	0.300	16,000	0.086	0.200	0.300	7,000	0.131
	20	0.300	0.300	16,000	0.079	0.200	0.300	7,000	0.119
	25	0.300	0.300	16,000	0.071	0.150	0.300	7,000	0.106
	30	0.200	0.300	14,000	0.073	0.150	0.300	6,500	0.102
	35	0.200	0.300	13,000	0.069	0.120	0.300	5,800	0.099
	40	0.200	0.300	12,000	0.065	0.100	0.300	5,200	0.094
	50	0.100	0.300	8,200	0.066	0.050	0.300	4,000	0.080
60	0.070	0.300	6,000	0.050	0.030	0.300	2,500	0.060	

BN 30
BN 45
BN 60
BN 60X
DM70 -
BN 70
BN GR



BALLNOSE



BN GR

Diamond coated end mills special for machining graphite and composite reinforced plastic fiber glass (CRP)

Index - BN GR, For Thermoplastic & Graphite

 Suitable for Material Groups
  Adapté pour les matériaux
  适用于材料
 Geeignet für die Materialgruppen
  Adatto per il materiale



EDP Number	Type	No. Z	Helix Angle	Coating	Performance	Page Number
754 	BN GR	2	30°	DCT01	G	437
756 	BN GR Long	2	30°	DCT01	G	438
B85 	BN GR Extra-Long	2	30°	DCT01	G	439

G - General P - Performance

BN GR BALLNOSE CUTTERS, 2 FLUTES

- VHM BN GR Radiusschaftfräser, 2 Zähne, DIAMANT bzw. DLC beschichtet zur Bearbeitung von Grafit
- Frese sferiche BN GR, 2 taglianti, diamantate per lavorazioni in grafite
- Fraises BN GR standard à bout hémisphérique, 2 dents, diamanté pour usinage de graphite
- 整体硬质合金 BN GR 系列 DLC 钻石涂层2刃石墨球头铣刀



Order Number	Dimension (mm)						DCT01
	D	R	l1	l2	L	d2 (h6)	
754 0100 040 03	1	0.5	3		40	3	•
754 0150 040 03	1.5	0.75			40	3	•
754 0200 040 03	2	1	4		40	3	◦
754 0250 040 03	2.5	1.25			40	3	◦
754 0300	3	1.5	5		40	3	•
754 0400	4	2	8		50	4	•
754 0600	6	3	10		60	6	•
754 0800	8	4	12		64	8	•
754 1000	10	5	14		70	10	•
754 1200	12	6	16		75	12	•

Material Group | Material-Gruppe | Groupe Matière | Gruppo Materiali | 材质主类

Cutting Parameter

N01	N02	N03	K01	K02	P01	P02	P03	M01	M02	S01	S02	S03	H01	H02	O01	O02	440
-----	-----	-----	-----	-----	-----	-----	-----	-----	-----	-----	-----	-----	-----	-----	-----	-----	-----

BN 30
BN 45
BN 60
BN 60X
DM70 - BN 70
BN GR

BN GR BALLNOSE CUTTERS WITH LONG NECK, 2 FLUTES

- VHM BN GR Radiuschaftfräser 2 Zähne, mit Freistellung, DIAMANT bzw. DLC beschichtet, zur Bearbeitung von Grafit
- Frese sferiche lunghe BN GR, con codolo ridotto, 2 taglienti, diamantate per lavorazioni in grafite
- Fraises BN GR à bout hémisphérique, 2 dents, diamanté pour usinage de graphite
- 整体硬质合金 BN GR 系列 DLC 钻石涂层2刃长型长颈石墨球头铣刀



Order Number	Dimension (mm)							DCT01
	D	R	l1	l2	L	d1	d2 (h6)	
756 0050 050 0300 060	0.5	0.25	1	6	50	0.45	3	•
756 0050 050 0300 080				8	50	0.45	3	•
756 0060 050 0300 060	0.6	0.3	1.2	6	50	0.55	3	•
756 0060 050 0300 080				8	50	0.55	3	•
756 0060 050 0300 100				10	50	0.55	3	•
756 0080 050 0300 080	0.8	0.4	1.6	8	50	0.75	3	•
756 0080 050 0300 100				10	50	0.75	3	•
756 0080 050 0300 120				12	50	0.75	3	•
756 0100 060 0300 100	1	0.5	3	10	60	0.9	3	•
756 0100 060 0300 120				12	60	0.9	3	•
756 0100 060 0300 160				16	60	0.9	3	•
756 0100 060 0400 100				10	60	0.9	4	•
756 0100 060 0400 120				12	60	0.9	4	•
756 0100 060 0400 160				16	60	0.9	4	•
756 0150 060 0300 100	1.5	0.75	3	10	60	1.4	3	◦
756 0150 060 0300 160				16	60	1.4	3	•
756 0150 060 0300 180				18	60	1.4	3	◦
756 0150 060 0300 200				20	60	1.4	3	◦
756 0150 060 0400 100				10	60	1.4	4	•
756 0150 060 0400 160				16	60	1.4	4	•
756 0150 060 0400 180	18	60	1.4	4	•			
756 0150 060 0400 200	20	60	1.4	4	•			
756 0200 060 0300 100	2	1	4	10	60	1.9	3	•
756 0200 060 0300 160				16	60	1.9	3	•
756 0200 060 0300 200				20	60	1.9	3	•
756 0200 060 0400 100				10	50	1.9	4	•
756 0200 060 0400 160	16	50	1.9	4	•			
756 0200 060 0400 200	20	60	1.9	4	•			
756 0300 075 03	3	1.5	5	75	75	2.8	3	•
756 0300 075 0400 150				15	75	2.8	4	•
756 0300 075 0400 300				30	75	2.8	4	•
756 0400 075 04	4	2	6	75	2.8	4	◦	
756 0400 100 04			8	100	2.8	4	•	
756 0600 075 06	6	3	10	75	2.8	6	•	
756 0600 100 06			10	100	2.8	6	•	
756 0800 100 08	8	4	12	100	2.8	8	•	
756 0800 150 08			150	2.8	8	•		
756 1000 100 10			100	2.8	10	•		
756 1000 150 10	10	5	14	150	2.8	10	◦	
756 1200 100 12			100	2.8	12	•		
756 1200 150 12	12	6	16	150	2.8	12	◦	

BN 30
BN 45
BN 60
BN 60X
DM70 -
BN70
BN GR

Material Group | Material-Gruppe | Groupe Matière | Gruppo Materiali | 材质主类

Cutting Parameter

N01	N02	N03	K01	K02	P01	P02	P03	M01	M02	S01	S02	S03	H01	H02	O01	O02	440
-----	-----	-----	-----	-----	-----	-----	-----	-----	-----	-----	-----	-----	-----	-----	-----	-----	-----

BN GR EXTRA-LONG BALLNOSE CUTTERS, 2 FLUTES

- VHM BN GR Radiuschaftfräser, extra-lang, 2 Zähne, DIAMANT bzw. DLC beschichtet, zur Bearbeitung von Grafit
- Frese sferiche extra-lunghe tipo BN GR, 2 taglienti, diamantate per lavorazioni in grafite
- Fraises BN GR extra-longues à bout hémisphérique, 2 dents, diamanté pour usinage de graphite
- 整体硬质合金 BN GR 系列 DLC 钻石涂层2刃加长型石墨球头铣刀

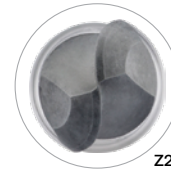
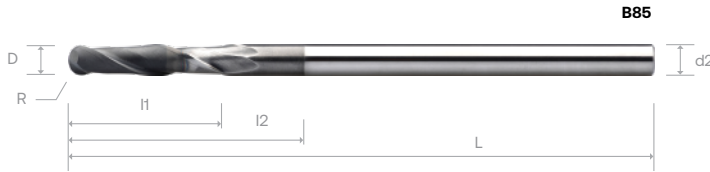

Order Number	Dimension (mm)						DCT01
	D	R	l1	l2	L	d2 (h6)	
B85 0200 080 03	2	1	10	20	80	3	•
B85 0300 080 03	3	1.5	15	25	80	3	•
B85 0400	4	2	20	30	100	4	•
B85 0500	5	2.5	30	50	120	5	•
B85 0600	6	3		50	150	6	•
B85 0800	8	4	40	60	150	8	•

Material Group | Material-Gruppe | Groupe Matière | Gruppo Materiali | 材质主类

Cutting Parameter

N01	N02	N03	K01	K02	P01	P02	P03	M01	M02	S01	S02	S03	H01	H02	O01	O02	440
-----	-----	-----	-----	-----	-----	-----	-----	-----	-----	-----	-----	-----	-----	-----	-----	-----	-----

BN 30
BN 45
BN 60
BN 60X
DM70 - BN70
BN GR

Note: These recommended cutting data indicators are just for reference. They should be adjusted according to the different cutting condition



BN GR Ballnose Cutters, 2 Flutes - 754

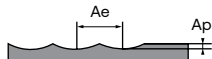

Roughing		
Working Material		
Graphite		
Properties		
-		
Cutting depth, ap		
0.10 × D		
Cutting Width, ae		
0.30 × D		
D	Vc	Fz
1	280	0.007
2		0.015
3		0.025
4		0.034
6		0.052
8		0.071
10		0.090
12		0.109

BN GR Ballnose Cutters, 2 Flutes - 754

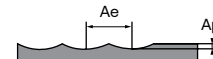

Finishing		
Working Material		
Graphite		
Properties		
-		
Cutting depth, ap		
0.05 × D		
Cutting Width, ae		
0.02 × D		
D	Vc	Fz
1	300	0.005
2		0.011
3		0.018
4		0.026
6		0.040
8		0.054
10		0.068
12		0.082

BN GR Ballnose Cutters with Long Neck, 2 Flutes - 756

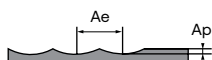

Roughing		
Working Material		
Graphite		
Properties		
-		
Cutting depth, ap		
0.10 × D		
Cutting Width, ae		
0.15 × D		
D	Vc	Fz
1	210	0.004
2		0.013
3		0.022
4		0.030
6		0.046
8		0.063
10		0.081
12		0.098

BN GR Ballnose Cutters with Long Neck, 2 Flutes - 756

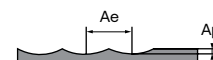

Finishing		
Working Material		
Graphite		
Properties		
-		
Cutting depth, ap		
0.05 × D		
Cutting Width, ae		
0.02 × D		
D	Vc	Fz
1	230	0.002
2		0.011
3		0.019
4		0.026
6		0.040
8		0.055
10		0.070
12		0.085

BN GR Extra- Long Ballnose Cutters, 2 Flutes - B85

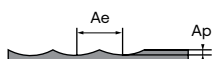

Roughing		
Working Material		
Graphite		
Properties		
-		
Cutting depth, ap		
0.10 × D		
Cutting Width, ae		
0.30 × D		
D	Vc	Fz
2	240	0.011
3		0.025
4		0.035
5		0.045
6		0.055
8		0.075

BN GR Extra- Long Ballnose Cutters, 2 Flutes - B85

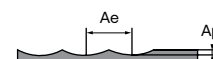

Finishing		
Working Material		
Graphite		
Properties		
-		
Cutting depth, ap		
0.05 × D		
Cutting Width, ae		
0.02 × D		
D	Vc	Fz
2	260	0.009
3		0.020
4		0.028
5		0.037
6		0.047
8		0.065

BN 30
BN 45
BN 60
BN 60X
DM70 -
BN 70
BN GR

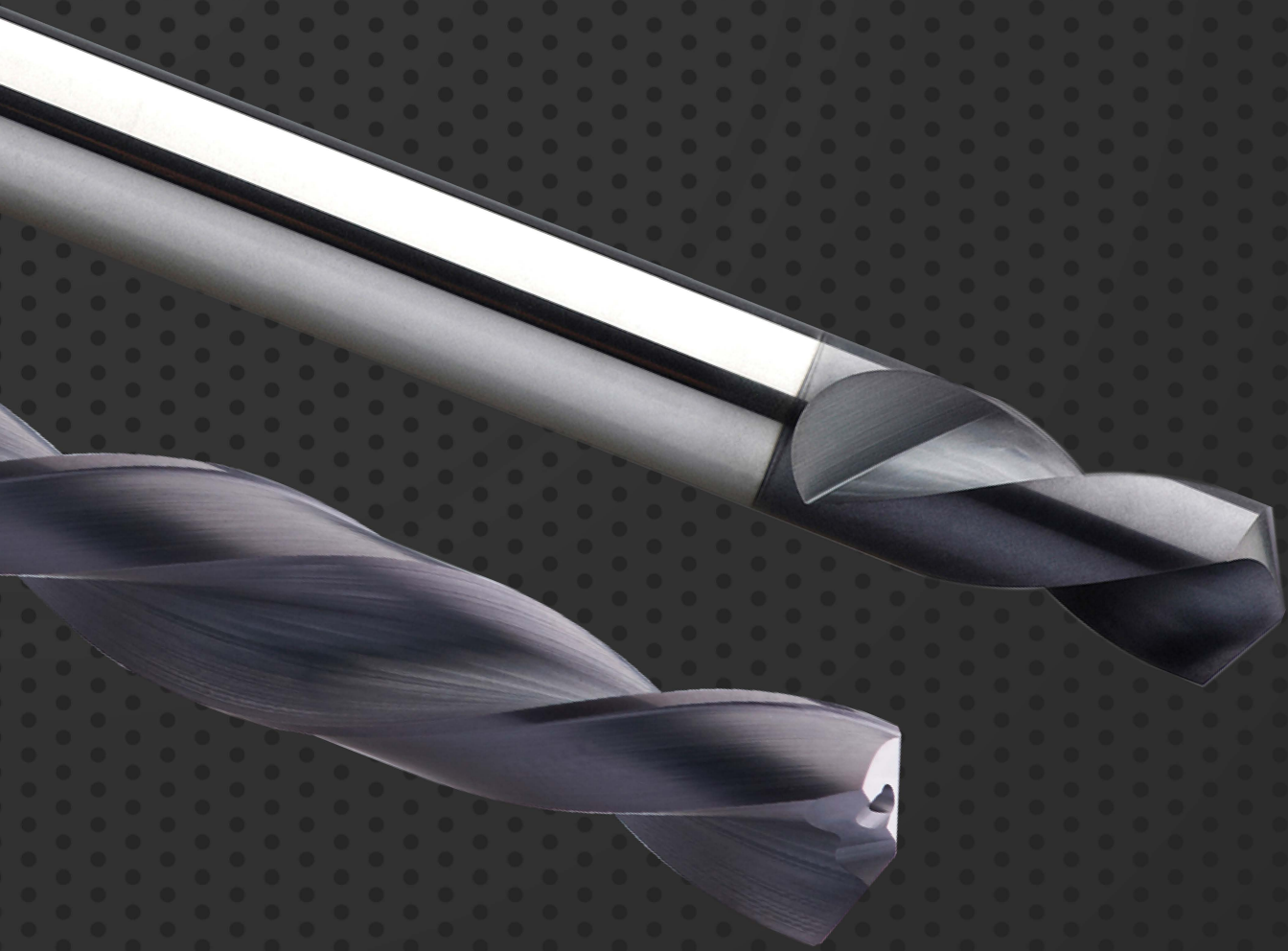

DRILLS

For material application is up to 68 HRC

Index - Drills, For 35 - 68 HRC

Suitable for Material Groups

Adapté pour les matériaux

适用于材料

Geeignet für die Materialgruppen

Adatto per il materiale

P	M	K	N
S	H	O	

EDP Number	Hardness	Type	No. Z	Helix Angle	Coating	Performance	Page Number
662	≤ 35 HRC	DR NC 60°	2	30°	UC	G	443
953		DR NC 60°	2	30°	B0819	G	443
664		DR NC 90°	2	30°	UC	G	444
955		DR NC 90°	2	30°	B0819	G	444
666		DR NC 120°	2	30°	UC	G	445
957		DR NC 120°	2	30°	B0819	G	445
D09	Non Ferrous Metal	DR ALU OF - 3 x Ø	2	30°	UC	P	449
D10		DR ALU OF - 5 x Ø	2	30°	UC	P	450
NEW W16	≤ 35 HRC	EZ Drill - 3 x Ø	2	30°	T8090	G	454
NEW W17		EZ Drill - 5 x Ø	2	30°	T8090	G	456
D07		DR NiTiCo OF - 3 x Ø	2	30°	T8090	P	459
D08		DR NiTiCo OF - 5 x Ø	2	30°	T8090	P	460
C73	≤ 45 HRC	DR VA OF - 3 x Ø	2	30°	T8090	P	464
C77		DR VA OF - 5 x Ø	2	30°	T8090	P	465
W08		DR-S - 3 x Ø	2	30°	T8090	P	469
W09		DR-S - 5 x Ø	2	30°	T8090	P	470
W10		DR-S OF - 3 x Ø	2	30°	T8090	P	471
W11		DR-S OF - 5 x Ø	2	30°	T8090	P	472
H03		DR MINI OF - 5 x Ø, 8x Ø, 12 x Ø, 15x Ø, 20x Ø, 25x Ø, 30x Ø	2	30°	T8090	P	479
NEW W05		DR-LX OF - 12 x Ø, 15x Ø, 20x Ø, 25x Ø, 30x Ø	2	30°	T8090	P	485
F33		DR 45 SB OF - 8 x Ø	2	30°	T8090	P	493
821		≤ 60 HRC	DR 60 - 5 x Ø	2	15°	D0120	P
823	DR 60 - 3 x Ø		2	15°	D0120	P	498

G - General P - Performance

NC SPOTTING DRILLS, 60° POINT ANGLE

- VHM NC Positionierungsbohrer Spitzenwinkel: 60°
- Punte pilota NC, con angolo di punta 60°
- Forets NC de pointage, angle de pointe: 60°
- 整体硬质合金 定心钻 2刃-顶角60°



Order Number	Dimension (mm)					UC	Order Number	Dimension (mm)					B0819	
	D (h6)	I 1	I 2	L	d2 (h6)			D (h6)	I 1	I 2	L	d2 (h6)		
662 0300 040				40	3	°	953 0300 040				40	3	°	
662 0300 060	3	6		60	3	•	953 0300 060	3	6		60	3	•	
662 0300 100				100	3	°	953 0300 100				100	3	°	
662 0400 050				50	4	•	953 0400 050				50	4	•	
662 0400 075	4	8		75	4	°	953 0400 075	4	8		75	4	°	
662 0400 100				100	4	°	953 0400 100				100	4	°	
662 0500 050				50	5	•	953 0500 050				50	5	•	
662 0500 075	5	12		75	5	°	953 0500 075	5	12		75	5	°	
662 0500 100				100	5	°	953 0500 100				100	5	°	
662 0600 050				50	6	•	953 0600 050				50	6	•	
662 0600 075	6	16		75	6	°	953 0600 075	6	16		75	6	°	
662 0600 100				100	6	•	953 0600 100				100	6	°	
662 0800 064	8	20		64	8	•	953 0800 064	8	20		64	8	•	
662 0800 100				100	8	°	953 0800 100				100	8	°	
662 1000 070				70	10	•	953 1000 070				70	10	•	
662 1000 100	10			100	10	°	953 1000 100	10			100	10	°	
662 1000 125				125	10	°	953 1000 125				125	10	°	
662 1000 150		25		150	10	°	953 1000 150		25		150	10	•	
662 1200 075				75	12	•	953 1200 075				75	12	•	
662 1200 100	12			100	12	°	953 1200 100	12			100	12	•	
662 1200 125				125	12	°	953 1200 125				125	12	°	
662 1200 150				150	12	°	953 1200 150				150	12	°	
662 1600 090				90	16	°	953 1600 090				90	16	•	
662 1600 125	16	26		125	16	°	953 1600 125	16	26		125	16	°	
662 1600 150				150	16	°	953 1600 150				150	16	°	

Material Group | Material-Gruppe | Groupe Matière | Gruppo Materiali | 材质主类

N01
N02
N03
K01
K02
P01
P02
P03
M01
M02
S01
S02
S03
H01
H02
O01
O02

Cutting Parameter

446

NC SPOTTING DRILLS, 90° POINT ANGLE

- VHM NC Positionierungsbohrer Spizenwinkel: 90°
- Punta pilota NC, con angolo di punta 90°
- Forets NC de pointage, angle de pointe: 90°
- 整体硬质合金 定心钻 2刃-顶角90°



Order Number	Dimension (mm)					UC	Order Number	Dimension (mm)					B0819	
	D (h6)	I1	I2	L	d2 (h6)			D (h6)	I1	I2	L	d2 (h6)		
664 0300 040				40	3	•	955 0300 040				40	3	•	
664 0300 060	3	6		60	3	•	955 0300 060	3	6		60	3	•	
664 0300 100				100	3	•	955 0300 100				100	3	•	
664 0400 050				50	4	•	955 0400 050				50	4	•	
664 0400 075	4	8		75	4	◦	955 0400 075	4	8		75	4	◦	
664 0400 100				100	4	•	955 0400 100				100	4	◦	
664 0500 050				50	5	•	955 0500 050				50	5	•	
664 0500 075	5	12		75	5	◦	955 0500 075	5	12		75	5	◦	
664 0500 100				100	5	•	955 0500 100				100	5	◦	
664 0600 050				50	6	•	955 0600 050				50	6	•	
664 0600 075	6	16		75	6	◦	955 0600 075	6	16		75	6	•	
664 0600 100				100	6	•	955 0600 100				100	6	•	
664 0800 064	8	20		64	8	•	955 0800 064	8	20		64	8	•	
664 0800 100				100	8	•	955 0800 100				100	8	◦	
664 1000 070				70	10	•	955 1000 070				70	10	•	
664 1000 100	10			100	10	◦	955 1000 100	10			100	10	◦	
664 1000 125				125	10	◦	955 1000 125				125	10	•	
664 1000 150		25		150	10	◦	955 1000 150		25		150	10	•	
664 1200 075				75	12	◦	955 1200 075				75	12	•	
664 1200 100	12			100	12	•	955 1200 100	12			100	12	•	
664 1200 125				125	12	◦	955 1200 125				125	12	◦	
664 1200 150				150	12	◦	955 1200 150				150	12	◦	
664 1600 090				90	16	◦	955 1600 090				90	16	•	
664 1600 125	16	26		125	16	◦	955 1600 125	16	26		125	16	◦	
664 1600 150				150	16	◦	955 1600 150				150	16	•	

NC SPOT
 DR ALU
 EZ LINE -
 DRILL
 DR NITCO
 DR VA
 DR-S
 DR MINI
 DR-LX
 DR 45 SB
 DR 60

Material Group | Material-Gruppe | Groupe Matière | Gruppo Materiali | 材质主类

N01
N02
N03
K01
K02
P01
P02
P03
M01
M02
S01
S02
S03
H01
H02
O01
O02

Cutting Parameter
446

NC SPOTTING DRILLS, 120° POINT ANGLE

- VHM NC Positionierungsbohrer Spitzenwinkel: 120°
- Punte pilota NC, con angolo di punta 120°
- Forets NC de pointage, angle de pointe: 120°
- 整体硬质合金 定心钻 2刃-顶角120°



Order Number	Dimension (mm)					UC	Order Number	Dimension (mm)					B0819	
	D (h6)	I 1	I 2	L	d2 (h6)			D (h6)	I 1	I 2	L	d2 (h6)		
666 0300 040				40	3	°	957 0300 040				40	3	°	
666 0300 060	3	6		60	3	°	957 0300 060	3	6		60	3	°	
666 0300 100				100	3	°	957 0300 100				100	3	°	
666 0400 050				50	4	°	957 0400 050				50	4	°	
666 0400 075	4	8		75	4	°	957 0400 075	4	8		75	4	°	
666 0400 100				100	4	°	957 0400 100				100	4	°	
666 0500 050				50	5	°	957 0500 050				50	5	°	
666 0500 075	5	12		75	5	°	957 0500 075	5	12		75	5	°	
666 0500 100				100	5	°	957 0500 100				100	5	°	
666 0600 050				50	6	°	957 0600 050				50	6	°	
666 0600 075	6	16		75	6	°	957 0600 075	6	16		75	6	°	
666 0600 100				100	6	°	957 0600 100				100	6	°	
666 0800 064				64	8	°	957 0800 064				64	8	°	
666 0800 100	8	20		100	8	°	957 0800 100	8	20		100	8	°	
666 1000 070				70	10	°	957 1000 070				70	10	°	
666 1000 100				100	10	°	957 1000 100				100	10	°	
666 1000 125	10	25		125	10	°	957 1000 125	10	25		125	10	°	
666 1000 150				150	10	°	957 1000 150				150	10	°	
666 1200 075				75	12	°	957 1200 075				75	12	°	
666 1200 100				100	12	°	957 1200 100				100	12	°	
666 1200 125	12	25		125	12	°	957 1200 125	12	25		125	12	°	
666 1200 150				150	12	°	957 1200 150				150	12	°	
666 1600 090				90	16	°	957 1600 090				90	16	°	
666 1600 125	16	26		125	16	°	957 1600 125	16	26		125	16	°	
666 1600 150				150	16	°	957 1600 150				150	16	°	

Material Group | Material-Gruppe | Groupe Matière | Gruppo Materiali | 材质主类

N01
N02
N03
K01
K02
P01
P02
P03
M01
M02
S01
S02
S03
H01
H02
O01
O02

Cutting Parameter

446

NC SPOT
 DR ALU
 EZ LINE - DRILL
 DR NITICO
 DR VA
 DR-S
 DR MINI
 DR-LX
 DR 45 SB
 DR 60

Recommended Cutting Data



Note: These recommended cutting data indicators are just for reference. They should be adjusted according to the different cutting condition



NC Spotting Drills, 60°, 90°, 120° - 662, 664, 666, 953, 955, 957

Spotting	N						K				S		
Working Material	Wrought Aluminium		Cast Aluminium		Copper Alloy		Grey Cast Iron		Ductile Cast Iron		Titanium alloy		
Properties	Si < 9%		Si ≥ 9%		-		-		-		-		
D	Vc	fn	Vc	fn	Vc	fn	Vc	fn	Vc	fn	Vc	fn	
3	220	0.055	150	0.053			110	0.052	60	0.037	40	0.034	
4		0.075		0.073				0.071		0.052		0.045	
5		0.097		0.095				0.092		0.090		0.066	0.060
6		0.120		0.118				0.112		0.110		0.082	0.074
8		0.164		0.162				0.152		0.150		0.115	0.105
10		0.210		0.208				0.192		0.185		0.142	0.135
12		0.280		0.274				0.235		0.233		0.190	0.175
16		0.345		0.342				0.312		0.305		0.245	0.235

NC Spotting Drills, 60°, 90°, 120° - 662, 664, 666, 953, 955, 957

Spotting	P						M				S		
Working Material	Carbon Steel		Alloy Steel		Prehardened Steel		Stainless Steel		Stainless Steel		Nickel Alloy		
Properties	-		520 < Rm < 1200		35 ≤ HRC < 45		High Machinability		Low Machinability		-		
D	Vc	fn	Vc	fn	Vc	fn	Vc	fn	Vc	fn	Vc	fn	
3	120	0.055	100	0.047	85		70	0.041	50	0.036	30	0.030	
4		0.074		0.064				0.062		0.056		0.050	0.040
5		0.094		0.084				0.080		0.073		0.064	0.054
6		0.115		0.101				0.096		0.088		0.080	0.065
8		0.155		0.140				0.134		0.125		0.110	0.085
10		0.193		0.176				0.166		0.155		0.140	0.120
12		0.248		0.220				0.215		0.200		0.180	0.170
16		0.320		0.288				0.280		0.258		0.242	0.215

NC SPOT
DR ALU
EZ LINE -
DRILL
DR NITCO
DR VA
DR-S
DR MINI
DR-LX
DR 45 SB
DR 60

FEATURES & BENEFITS

DR Alu



1 Self-Centering Geometry

Excellent hole quality without centre drilling operations

3 Flutes Polished

Ensures fast, efficient chips evacuation and drastically reduces built-up edge

5 Top Edge Flute Geometry

The reduced flute geometry generates initial cutting and fracturing of the chips to promote smooth chip evacuation

2 Curved Flute Shape

Maximum chip space for fast chip evacuation
initial cutting point near the center

4 Oil Hole for High Performance Drilling

- Increases cutting speeds and feeds by more than 30%
- Improves surface finish on the machined component

6 Sharp Cutting Edges

Allow for improved shearing capability and chip control in aluminium alloys

7 Suitable for Material





1. Selbstzentrierende Geometrie
Ausgezeichnete Bohrungsqualität ohne Vorzentrieren
2. Bogenförmige Nutenform
Maximaler Spanraum für schnellen Spanabfluß
Anfangsschnittpunkt in der Nähe des Zentrums
3. Polierte Schneiden
Sorgt für schnellen effizienten Spänefluß und reduziert die Bildung von Aufbauschneiden
4. Kühlkanalbohrer für Hochleistungsbohren
Erhöht die Schnittgeschwindigkeit und den Vorschub um mehr als 30%
Verbessert die Oberflächenqualität am Werkstück
5. Schneidkanten- und Nutengeometrie
Durch die einfache Schneidenform werden die ersten Späne so schnell gebrochen, dass diese leichter abgeführt werden können.
6. Scharfe Schneidkanten
Ermöglicht verbesserte Scherfähigkeit und Spansteuerung in Aluminiumlegierungen
7. Geeignet für die Materialgruppen N, O



1. 自定心几何形状
无中心钻孔作业的优质钻孔质量。
2. 弯曲的槽形设计
最大的排屑空间, 实现快速排屑。
初始切削点靠近中心。
3. 高度抛光的排屑槽
确保快速、高效的排屑和极大减少铁屑堆积。
4. 用于高性能钻孔的内油孔
切削速率和进给提高 30% 以上。
改善机械加工部件的表面光洁度。
5. 顶边槽几何形状
减少的槽几何形状生成碎屑的初始切割和压裂。
促进平滑排屑。
6. 锋利的切削刃
允许改善铝合金的剪切能力和碎屑控制。
7. 适用于材料 N、O



1. Geometria autocentrante
Qualità del foro eccellenza senza operazioni di foratura centrale
2. Forma della scanalatura curva
Spazio massimo dei trucioli per un'evacuazione più veloce
Punta tagliente iniziale vicina al centro
3. Scanalature altamente levigate
Assicura una evacuazione rapida ed efficace e riduce enormemente la formazione di materiale di riporto
4. Foro dell'olio per foratura ad alte prestazione
aumenta le velocità di taglio e l'avanzamento di oltre il 30%
Migliora la finitura superficiale del componente lavorato
5. Geometria della scanalatura con bordo superiore
La geometri ridotta della scanalatura genera tagli e rotture iniziali
dei trucioli per favorirne un'evacuazione ottimale
6. Angoli di taglio affilati
Consente capacità di taglio migliorate e il controllo dei trucioli nelle leghe di acciaio
7. Adatto per il materiale N, O



1. Géométrie auto-centrant
Excellente géométrie et précision des trous
2. Goujure à forme incurvée
large goujure pour un degagement maximal des copeaux
3. Goujures hautement polies
Garantit une évacuation des copeaux rapide et efficace et réduit radicalement l'accumulation sur les arêtes
4. Trou d'huile
Augmente les vitesses de coupe de plus de 30 %
Améliore l'état de surface
5. Géométrie des goujures d'arête supérieure
La géométrie des goujures réduite génère une découpe et un fractionnement des copeaux pour favoriser une évacuation fluide des copeaux
6. Acuitée d'arête optimale
Permet un meilleur contrôle des copeaux dans les alliages d'aluminium
7. Adapté aux matériaux N, O

DR ALU OIL FEED TWIST DRILLS - DIN 6537K - 130° POINT ANGLE - 3 X Ø

- VHM DR ALU Kühlkanalbohrer nach DIN 6537K, 130° Spitzenwinkel, Schaft nach DIN 6535HA
- Punte elicoidali DR ALU a norma DIN 6537K - 3 x Ø, con foro di lubrificazione, angolo di punta 130°, codolo DIN 6535HA
- Forets hélicoïdaux DR ALU à trous d'huile selon DIN 6537K, angle de pointe 130°, queue selon DIN 6535HA
- 整体硬质合金 DR ALU 系列 内冷孔钻头-相等于DIN6537K 2刃-加工深度3xD, 柄部标准DIN6535HA, 顶角130°

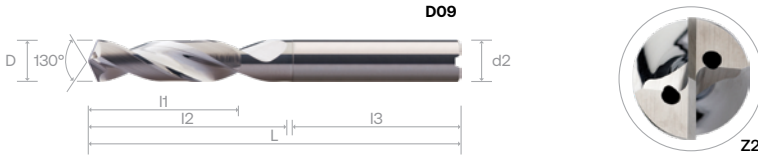

Order Number	Dimension (mm)						UC	Order Number	Dimension (mm)						UC	
	D (m7)	I1	I2	I3	L	d2 (h6)			D (m7)	I1	I2	I3	L	d2 (h6)		
D09 0300 062 03	3	14	20	36	62	3	○	D09 0790	7.9	29	41	36	79	8	●	
D09 0300 *			20	36	62	6	●	D09 0800	8		41	36	79	8	○	
D09 0310 062 03	3.1		20	36	62	3	○	D09 0810 079 08 *	8.1		41	36	79	8	○	
D09 0310 *			20	36	62	6	●	D09 0810 *			47	40	89	10	●	
D09 0320 062 03	3.2		20	36	62	3	○	D09 0820 *	8.2		47	40	89	10	○	
D09 0320 *			20	36	62	6	●	D09 0830 *	8.3		47	40	89	10	●	
D09 0330 *	3.3		20	36	62	6	○	D09 0840 *	8.4		47	40	89	10	●	
D09 0340 *	3.4		20	36	62	6	●	D09 0850 *	8.5		47	40	89	10	●	
D09 0350 *	3.5		20	36	62	6	●	D09 0860 *	8.6		47	40	89	10	○	
D09 0360 *	3.6		20	36	62	6	○	D09 0870 *	8.7		47	40	89	10	●	
D09 0370 *	3.7		20	36	62	6	○	D09 0880 *	8.8		47	40	89	10	●	
D09 0380 *	3.8		24	36	66	6	●	D09 0890 *	8.9		47	40	89	10	●	
D09 0390 *	3.9		24	36	66	6	○	D09 0900 *	9		47	40	89	10	●	
D09 0400 066 04	4		17	24	36	66	4	○	D09 0910 *		9.1	35	47	40	89	10
D09 0400 *				24	36	66	6	●	D09 0920 *	9.2	47		40	89	10	○
D09 0410 066 04		4.1		24	36	66	4	○	D09 0930 *	9.3	47		40	89	10	○
D09 0410 *				24	36	66	6	○	D09 0940 *	9.4	47		40	89	10	○
D09 0420 066 04		4.2		24	36	66	4	○	D09 0950 *	9.5	47		40	89	10	○
D09 0420 *				24	36	66	6	●	D09 0960 *	9.6	47		40	89	10	○
D09 0430 *		4.3		24	36	66	6	○	D09 0970 *	9.7	47		40	89	10	○
D09 0440 *		4.4		24	36	66	6	○	D09 0980 *	9.8	47		40	89	10	○
D09 0450 *		4.5		24	36	66	6	○	D09 0990 *	9.9	47		40	89	10	○
D09 0460 *		4.6		24	36	66	6	●	D09 1000 *	10	47		40	89	10	○
D09 0470 *		4.7		24	36	66	6	○	D09 1020 *	10.2	55		45	102	12	○
D09 0480 *		4.8		28	36	66	6	○	D09 1050 *	10.5	55		45	102	12	○
D09 0490 *		4.9		28	36	66	6	○	D09 1080 *	10.8	55		45	102	12	○
D09 0500 *		5		28	36	66	6	●	D09 1100 *	11	55		45	102	12	○
D09 0510 *	5.1	28	36	66	6	●	D09 1120 *	11.2	40	55	45	102	12	○		
D09 0520 *	5.2	28	36	66	6	○	D09 1130 *	11.3		55	45	102	12	○		
D09 0530 *	5.3	28	36	66	6	○	D09 1150 *	11.5		55	45	102	12	●		
D09 0540 *	5.4	28	36	66	6	○	D09 1180 *	11.8		55	45	102	12	○		
D09 0550 *	5.5	28	36	66	6	●	D09 1200 *	12		55	45	102	12	●		
D09 0560 *	5.6	28	36	66	6	○	D09 1220 *	12.2		60	45	107	14	○		
D09 0570 *	5.7	28	36	66	6	○	D09 1250 *	12.5		60	45	107	14	○		
D09 0580 *	5.8	28	36	66	6	●	D09 1270 *	12.7		60	45	107	14	○		
D09 0590 *	5.9	28	36	66	6	○	D09 1280 *	12.8		60	45	107	14	○		
D09 0600 *	6	28	36	66	6	●	D09 1300 *	13		43	60	45	107	14	●	
D09 0610 066 06 *	6.1	28	36	66	6	○	D09 1330 *	13.3			60	45	107	14	○	
D09 0610 *			34	36	79	8	●	D09 1350 *			13.5	60	45	107	14	●
D09 0620 *			34	36	79	8	●	D09 1370 *			13.7	60	45	107	14	○
D09 0630 *			34	36	79	8	○	D09 1380 *			13.8	60	45	107	14	○
D09 0640 *			34	36	79	8	○	D09 1400 *	14		60	45	107	14	●	
D09 0650 *			34	36	79	8	○	D09 1450 *	14.5		65	48	115	16	○	
D09 0660 *			34	36	79	8	○	D09 1500 *	15		65	48	115	16	○	
D09 0670 *			34	36	79	8	●	D09 1530 *	15.3		65	48	115	16	○	
D09 0680 *			34	36	79	8	○	D09 1550 *	15.5		65	48	115	16	○	
D09 0690 *			34	36	79	8	●	D09 1580 *	15.8		65	48	115	16	○	
D09 0700 *			34	36	79	8	○	D09 1600 *	16		65	48	115	16	●	
D09 0710 *			41	36	79	8	○	D09 1650 *	16.5		73	48	123	18	○	
D09 0720 *			41	36	79	8	○	D09 1700 *	17		73	48	123	18	○	
D09 0730 *			41	36	79	8	○	D09 1750 *	17.5	73	48	123	18	○		
D09 0740 *		41	36	79	8	○	D09 1800 *	18	73	48	123	18	○			
D09 0750 *		41	36	79	8	○	D09 1850 *	18.5	79	50	131	20	○			
D09 0760 *		41	36	79	8	○	D09 1900 *	19	79	50	131	20	○			
D09 0770 *		41	36	79	8	○	D09 1950 *	19.5	79	50	131	20	○			
D09 0780 *		41	36	79	8	○	D09 2000	20	79	50	131	20	○			

* - DIN 6535

Material Group | Material-Gruppe | Groupe Matière | Gruppo Materiali | 材质主类

N01	N02	N03	K01	K02	P01	P02	P03	M01	M02	S01	S02	S03	H01	H02	O01	O02	451
-----	-----	-----	-----	-----	-----	-----	-----	-----	-----	-----	-----	-----	-----	-----	-----	-----	-----

Cutting Parameter

DR ALU OIL FEED TWIST DRILLS - DIN 6537L - 130° POINT ANGLE - 5 X Ø

- VHM DR ALU Kühlkanalbohrer nach DIN 6537L, 130° Spitzenwinkel, Schaft nach DIN 6535HA
- Punta elicoidali DR ALU a norma DIN 6537L- 5 x Ø, con foro di lubrificazione, angolo di punta 130°, codolo DIN 6535HA
- Forets hélicoïdaux DR ALU à trous d'huile selon DIN 6537L - 5 x Ø, angle de pointe 130°, queue selon DIN 6535HA
- 整体硬质合金 DR ALU 系列 内冷孔钻头-相当于DIN6537L 2刃-加工深度5xD, 柄部标准DIN6535HA, 顶角130°

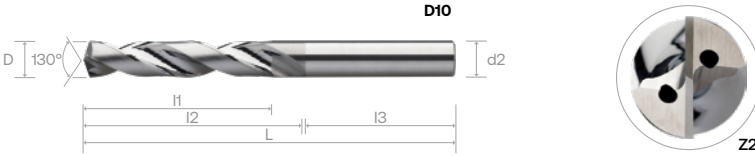

Order Number	Dimension (mm)						UC	Order Number	Dimension (mm)						UC
	D (m7)	I1	I2	I3	L	d2 (h6)			D (m7)	I1	I2	I3	L	d2 (h6)	
D10 0300 066 03	3	23	28	36	66	3	○	D10 0790	7.9	43	53	36	91	8	○
D10 0300 *	3		28	36	66	6	●	D10 0800	8		53	36	91	8	●
D10 0310 066 03	3.1		28	36	66	3	○	D10 0810 079 08 *	8.1		53	36	91	8	○
D10 0310 *	3.1		28	36	66	6	○	D10 0810	8.1		61	40	103	10	●
D10 0320 066 03	3.2		28	36	66	3	○	D10 0820	8.2		61	40	103	10	●
D10 0320 *	3.2		28	36	66	6	●	D10 0830	8.3		61	40	103	10	○
D10 0330 *	3.3		28	36	66	6	●	D10 0840	8.4		61	40	103	10	○
D10 0340 *	3.4		28	36	66	6	●	D10 0850	8.5		61	40	103	10	●
D10 0350 *	3.5		28	36	66	6	○	D10 0860 *	8.6		61	40	103	10	○
D10 0360 *	3.6		28	36	66	6	○	D10 0870 *	8.7		61	40	103	10	○
D10 0370 *	3.7	28	36	66	6	●	D10 0880 *	8.8	61	40	103	10	●		
D10 0380 *	3.8	36	36	74	6	●	D10 0890 *	8.9	61	40	103	10	●		
D10 0390 *	3.9	36	36	74	6	○	D10 0900 *	9	61	40	103	10	○		
D10 0400 074 04	4	36	36	74	4	○	D10 0910 *	9.1	61	40	103	10	○		
D10 0400 *	4	36	36	74	6	●	D10 0920 *	9.2	61	40	103	10	○		
D10 0410 074 04	4.1	36	36	74	4	○	D10 0930 *	9.3	61	40	103	10	●		
D10 0410 *	4.1	36	36	74	6	○	D10 0940 *	9.4	61	40	103	10	○		
D10 0420 074 04	4.2	36	36	74	4	○	D10 0950 *	9.5	61	40	103	10	●		
D10 0420 *	4.2	36	36	74	6	○	D10 0960 *	9.6	61	40	103	10	○		
D10 0430 *	4.3	36	36	74	6	○	D10 0970 *	9.7	61	40	103	10	○		
D10 0440 *	4.4	36	36	74	6	○	D10 0980 *	9.8	61	40	103	10	●		
D10 0450 *	4.5	36	36	74	6	●	D10 0990 *	9.9	61	40	103	10	●		
D10 0460 *	4.6	36	36	74	6	●	D10 1000 *	10	61	40	103	10	○		
D10 0470 *	4.7	36	36	74	6	●	D10 1020 *	10.2	71	45	118	12	○		
D10 0480 *	4.8	44	36	82	6	○	D10 1050 *	10.5	71	45	118	12	●		
D10 0490 *	4.9	44	36	82	6	○	D10 1080 *	10.8	71	45	118	12	○		
D10 0500 *	5	44	36	82	6	●	D10 1100 *	11	71	45	118	12	●		
D10 0510 *	5.1	44	36	82	6	●	D10 1120 *	11.2	71	45	118	12	●		
D10 0520 *	5.2	44	36	82	6	●	D10 1130 *	11.3	71	45	118	12	○		
D10 0530 *	5.3	44	36	82	6	○	D10 1150 *	11.5	71	45	118	12	●		
D10 0540 *	5.4	44	36	82	6	○	D10 1180 *	11.8	71	45	118	12	○		
D10 0550 *	5.5	44	36	82	6	●	D10 1200 *	12	71	45	118	12	●		
D10 0560 *	5.6	44	36	82	6	●	D10 1220 *	12.2	77	45	124	14	○		
D10 0570 *	5.7	44	36	82	6	○	D10 1250 *	12.5	77	45	124	14	●		
D10 0580 *	5.8	44	36	82	6	○	D10 1270 *	12.7	77	45	124	14	○		
D10 0590 *	5.9	44	36	82	6	○	D10 1280 *	12.8	77	45	124	14	○		
D10 0600 *	6	44	36	82	6	●	D10 1300 *	13	77	45	124	14	●		
D10 0610 066 06 *	6.1	44	36	82	6	○	D10 1330 *	13.3	77	45	124	14	○		
D10 0610 *	6.1	53	36	91	8	○	D10 1350 *	13.5	77	45	124	14	○		
D10 0620 *	6.2	53	36	91	8	○	D10 1370 *	13.7	77	45	124	14	○		
D10 0630 *	6.3	53	36	91	8	○	D10 1380 *	13.8	77	45	124	14	○		
D10 0640 *	6.4	53	36	91	8	○	D10 1400 *	14	77	45	124	14	●		
D10 0650 *	6.5	53	36	91	8	○	D10 1450 *	14.5	83	48	133	16	○		
D10 0660 *	6.6	53	36	91	8	●	D10 1500 *	15	83	48	133	16	○		
D10 0670 *	6.7	53	36	91	8	●	D10 1530 *	15.3	83	48	133	16	○		
D10 0680 *	6.8	53	36	91	8	●	D10 1550 *	15.5	83	48	133	16	○		
D10 0690 *	6.9	53	36	91	8	○	D10 1580 *	15.8	83	48	133	16	○		
D10 0700 *	7	53	36	91	8	●	D10 1600 *	16	83	48	133	16	○		
D10 0710 *	7.1	53	36	91	8	●	D10 1650 *	16.5	93	48	143	18	○		
D10 0720 *	7.2	53	36	91	8	●	D10 1700 *	17	93	48	143	18	○		
D10 0730 *	7.3	53	36	91	8	○	D10 1750 *	17.5	93	48	143	18	○		
D10 0740 *	7.4	53	36	91	8	○	D10 1800 *	18	93	48	143	18	○		
D10 0750 *	7.5	53	36	91	8	●	D10 1850 *	18.5	101	50	153	20	○		
D10 0760 *	7.6	53	36	91	8	○	D10 1900 *	19	101	50	153	20	○		
D10 0770 *	7.7	53	36	91	8	○	D10 1950 *	19.5	101	50	153	20	○		
D10 0780 *	7.8	53	36	91	8	●	D10 2000 *	20	101	50	153	20	○		

* - DIN 6535

Material Group | Material-Gruppe | Groupe Matière | Gruppo Materiali | 材质主类

N01	N02	N03	K01	K02	P01	P02	P03	M01	M02	S01	S02	S03	H01	H02	O01	O02
-----	-----	-----	-----	-----	-----	-----	-----	-----	-----	-----	-----	-----	-----	-----	-----	-----

Cutting Parameter

451

NC SPOT
DR ALU
EZ LINE - DRILL
DR NITCO
DR VA
DR-S
DR MINI
DR-LX
DR 45 SB
DR 60

Note: These recommended cutting data indicators are just for reference. They should be adjusted according to the different cutting condition



DR ALU Oil Feed Twist Drills, 3xD & 5xD, 2 Flutes - D09, D10



Drilling	N					
Working Material	Wrought aluminum		Cast aluminum		Copper alloy	
Properties	Si < 9%		Si ≥ 9%		-	
D	Vc	fn	Vc	fn	Vc	fn
3	330	0.080	240	0.074		0.063
4		0.115		0.100		0.086
5		0.150		0.132		0.110
6		0.190		0.165		0.136
7		0.225		0.200		0.164
8		0.270		0.235		0.192
9		0.310		0.290		0.220
10		0.350		0.335		0.253
11		0.405		0.384		0.282
12		0.460		0.441		0.320
13		0.485		0.458		0.335
14		0.495		0.475		0.362
15		0.510		0.490		0.382
16		0.525		0.500		0.398
17		0.534		0.514		0.411
18		0.545		0.525		0.420
19		0.552		0.536		0.430
20		0.565		0.540		0.440

NC SPOT

DR ALU

EZ LINE -
DRILL

DR NITCO

DR VA

DR-S

DR MINI

DR-LX

DR 45 SB

DR 60

FEATURES & BENEFITS

EZ Line - Drill



1 Split Point Design

Provide Self Centering capability and reduce thrust

2 C flute shape

- Produce Small chips
- Improve Chip evacuation

3 Effective Clearance and Gash

- Lower cutting forces
- Improve chip formation and control

4 Corner reinforcement

Adds protection during the drilling process

5 Corner Chamfer on point Design

Reduce burr formation during through hole machining

6 Suitable for Material





1. Kreuzanschliff
Bietet Selbstzentrierung und reduzierten Axialdruck
2. C-förmige Nuten
Erzeugt kleine Späne
verbessert den Spänefluß
3. Effektiver Abstand und Schnitt
Niedrigere Schnittkräfte
Verbessert die Spanbildung und Kontrolle
4. Schneideckenverstärkung
sorgt für mehr Schutz beim Bohren
5. Schneideckenfase
Ideal für Gussbearbeitung und bessere
Oberflächengüte
6. Geeignet für die Materialien P, K, N, O



1. 不等分设计
提供自定心能力并减小阻力。
2. C型槽
产生小切屑。
改善排屑。
3. 有效容屑槽
减小阻力。
改善及控制切屑的形成。
4. 刀尖加固
在钻孔过程中增加保护。
5. 端部倒角
减少在通孔加工时产生的崩口及毛刺。
6. 适用于材料 P、K、N、O



1. Struttura del punto di ripartizione
Offre capacità autocentranti e spinta ridotta
2. Forma della scanalatura a C
Produce piccoli trucioli
Migliora l'evacuazione dei trucioli
3. Gioco e sgrassatura efficaci
Forze di taglio inferiori
Migliora la formazione e il controllo dei trucioli
4. Rafforzamento degli angoli
Aggiunge protezione durante il processo di foratura
5. Tagliente di smusso
Ideale per ghisa e migliore finitura superficiale
6. Adatto per il materiale P, K, N, O



1. Conception à affûtage 4 faces croisées
auto centrant, efforts de coupes réduit
2. Goujure à forme en C
très bon brise copeaux
Améliore l'évacuation des copeaux
3. Dégagement et rainure de logement efficaces
Forces de coupe inférieures
Améliore la formation et le contrôle des copeaux
4. Rayon torique sur les arêtes
pour une meilleur protection pendant le perçage
5. Arête chanfrein de coin
Idéal pour la fonte et meilleure finition de surface
6. Adapté aux matériaux P, K, N, O

EZ TWIST DRILLS - DIN 6537K - 3 x Ø

- VHM EZ Spiralbohrer nach DIN 6537K, 140° Spitzenwinkel, Schaft nach DIN 6535HA
- Punte elicoidali EZ a norma DIN 6537K, 3 x Ø, con angolo di punta 140°, codolo DIN 6535HA
- Forets hélicoïdaux EZ selon DIN 6537K - 3 x Ø, angle de pointe 140°, queue selon DIN 6535HA
- 整体硬质合金 EZ 钻头-相等于DIN 6537K- 3 x Ø 2刃-加工深度3xD, 顶角140°

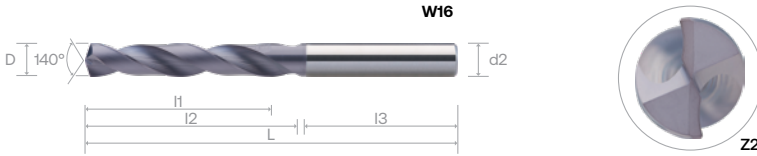
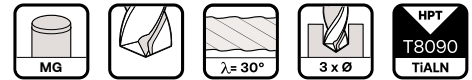

Order Number	Dimension (mm)						T8090	Order Number	Dimension (mm)						T8090		
	D (m7)	I1	I2	I3	L	d2 (h6)			D (m7)	I1	I2	I3	L	d2 (h6)			
W16 0100	1	7		33	45	3	•	W16 0610	6.1	34		36	79	8	•		
W16 0110	1.1			33	45	3	•	W16 0620	6.2			36	79	8	•		
W16 0120	1.2			33	45	3	•	W16 0630	6.3			36	79	8	•		
W16 0130	1.3			33	45	3	•	W16 0640	6.4			36	79	8	◦		
W16 0140	1.4	14		33	45	3	•	W16 0650	6.5			36	79	8	•		
W16 0150	1.5			35	50	3	•	W16 0660	6.6			36	79	8	•		
W16 0160	1.6			35	50	3	•	W16 0670	6.7			36	79	8	•		
W16 0170	1.7			35	50	3	•	W16 0680	6.8			36	79	8	•		
W16 0180	1.8	20		35	50	3	•	W16 0690	6.9			36	79	8	•		
W16 0190	1.9			35	50	3	•	W16 0700	7			36	79	8	•		
W16 0200	2			36	55	4	•	W16 0710	7.1			36	79	8	◦		
W16 0210	2.1			36	55	4	•	W16 0720	7.2			36	79	8	◦		
W16 0220	2.2	24		36	55	4	•	W16 0730	7.3			36	79	8	◦		
W16 0230	2.3			36	55	4	•	W16 0740	7.4			36	79	8	◦		
W16 0240	2.4			36	55	4	•	W16 0750	7.5		41		36	79	8	•	
W16 0250	2.5			36	55	4	•	W16 0760	7.6				36	79	8	•	
W16 0260	2.6		36	55	4	•	W16 0770	7.7		36		79	8	◦			
W16 0270	2.7		36	55	4	•	W16 0780	7.8		36		79	8	•			
W16 0280	2.8	28		36	55	4	•	W16 0790	7.9			36	79	8	•		
W16 0290	2.9			36	55	4	•	W16 0800	8			36	79	8	•		
W16 0300	3			36	62	6	•	W16 0810	8.1	47			40	89	10	•	
W16 0310	3.1			36	62	6	•	W16 0820	8.2				40	89	10	•	
W16 0320	3.2		36	62	6	•	W16 0830	8.3				40	89	10	•		
W16 0330	3.3		36	62	6	•	W16 0840	8.4				40	89	10	◦		
W16 0340	3.4	24		36	62	6	•	W16 0850	8.5				40	89	10	•	
W16 0350	3.5			36	62	6	•	W16 0860	8.6				40	89	10	◦	
W16 0360	3.6			36	62	6	•	W16 0870	8.7				40	89	10	◦	
W16 0370	3.7			36	62	6	•	W16 0880	8.8				40	89	10	◦	
W16 0380	3.8	28		36	66	6	•	W16 0890	8.9				40	89	10	◦	
W16 0390	3.9			36	66	6	•	W16 0900	9				40	89	10	•	
W16 0400	4			36	66	6	•	W16 0910	9.1			40	89	10	◦		
W16 0410	4.1			36	66	6	•	W16 0920	9.2			40	89	10	◦		
W16 0420	4.2	24		36	66	6	•	W16 0930	9.3			40	89	10	◦		
W16 0430	4.3			36	66	6	•	W16 0940	9.4			40	89	10	◦		
W16 0440	4.4			36	66	6	•	W16 0950	9.5			40	89	10	◦		
W16 0450	4.5			36	66	6	•	W16 0960	9.6			40	89	10	◦		
W16 0460	4.6	28		36	66	6	•	W16 0970	9.7		40	89	10	◦			
W16 0470	4.7			36	66	6	•	W16 0980	9.8		40	89	10	•			
W16 0480	4.8			36	66	6	•	W16 0990	9.9		40	89	10	◦			
W16 0490	4.9			36	66	6	•	W16 1000	10		40	89	10	•			
W16 0500	5	28		36	66	6	•	W16 1010	10.1		45	102	12	◦			
W16 0510	5.1			36	66	6	•	W16 1020	10.2		45	102	12	•			
W16 0520	5.2			36	66	6	•	W16 1030	10.3		45	102	12	◦			
W16 0530	5.3			36	66	6	•	W16 1040	10.4		45	102	12	◦			
W16 0540	5.4			36	66	6	•	W16 1050	10.5		45	102	12	•			
W16 0550	5.5			36	66	6	•	W16 1060	10.6	55		45	102	12	◦		
W16 0560	5.6			36	66	6	•	W16 1070	10.7			45	102	12	◦		
W16 0570	5.7			36	66	6	•	W16 1080	10.8			45	102	12	◦		
W16 0580	5.8			36	66	6	•	W16 1090	10.9			45	102	12	◦		
W16 0590	5.9			36	66	6	•	W16 1100	11			45	102	12	•		
W16 0600	6			36	66	6	•	W16 1110	11.1			45	102	12	◦		

cont'd ▶

Material Group | Material-Gruppe | Groupe Matière | Gruppo Materiali | 材质主类

N01
N02
N03
K01
K02
P01
P02
P03
M01
M02
S01
S02
S03
H01
H02
O01
O02

Cutting Parameter

458

NC SPOT
 DR ALU
 EZ LINE - DRILL
 DR NITCO
 DR VA
 DR-S
 DR MINI
 DR-LX
 DR 45 SB
 DR 60

EZ TWIST DRILLS - DIN 6537K - 3 x Ø

- VHM EZ Spiralbohrer nach DIN 6537K, 140° Spitzenwinkel, Schaft nach DIN 6535HA
- Punte elicoidali EZ a norma DIN 6537K, 3 x Ø, con angolo di punta 140°, codolo DIN 6535HA
- Forets hélicoïdaux EZ selon DIN 6537K - 3 x Ø, angle de pointe 140°, queue selon DIN 6535HA
- 整体硬质合金 EZ 钻头-相等于DIN 6537K- 3 x Ø 2刃-加工深度3xD, 顶角140°

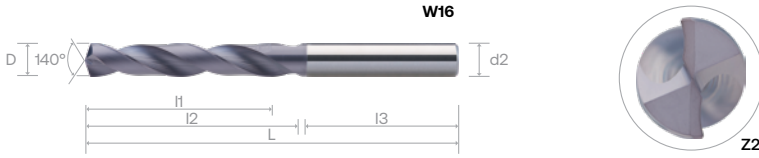

Order Number	Dimension (mm)						T8090	Order Number	Dimension (mm)						T8090
	D (m7)	I1	I2	I3	L	d2 (h6)			D (m7)	I1	I2	I3	L	d2 (h6)	
W16 1120	11.2	55		45	102	12	o								
W16 1130	11.3			45	102	12	o								
W16 1140	11.4			45	102	12	o								
W16 1150	11.5			45	102	12	o								
W16 1160	11.6			45	102	12	o								
W16 1170	11.7			45	102	12	o								
W16 1180	11.8			45	102	12	o								
W16 1190	11.9			45	102	12	o								
W16 1200	12			45	102	12	•								
W16 1220	12.2	60		45	107	14	o								
W16 1250	12.5			45	107	14	•								
W16 1270	12.7			45	107	14	o								
W16 1280	12.8			45	107	14	o								
W16 1300	13			45	107	14	o								
W16 1350	13.5			45	107	14	o								
W16 1370	13.7	65		45	107	14	o								
W16 1380	13.8			45	107	14	o								
W16 1400	14			45	107	14	o								
W16 1420	14.2			48	115	16	o								
W16 1450	14.5			48	115	16	o								
W16 1480	14.8			48	115	16	o								
W16 1500	15			48	115	16	o								
W16 1550	15.5			48	115	16	o								
W16 1580	15.8		48	115	16	o									
W16 1600	16		48	115	16	o									

Material Group | Material-Gruppe | Groupe Matière | Gruppo Materiali | 材质主类

N01
N02
N03
K01
K02
P01
P02
P03
M01
M02
S01
S02
S03
H01
H02
O01
O02

Cutting Parameter

458

EZ TWIST DRILLS - DIN 6537L - 5 x Ø

- VHM EZ Spiralbohrer nach DIN 6537L, 140° Spitzenwinkel, Schaft nach DIN 6535HA
- Punta elicoidali EZ a norma DIN 6537L, 5 x ø, con angolo di punta 140°, codolo DIN 6535HA
- Forets hélicoïdaux EZ selon DIN 6537L - 5 x Ø, angle de pointe 140°, queue selon DIN 6535HA
- 整体硬质合金 EZ 钻头-相等于DIN 6537L- 5 x Ø 2刃-加工深度3xD, 顶角140°

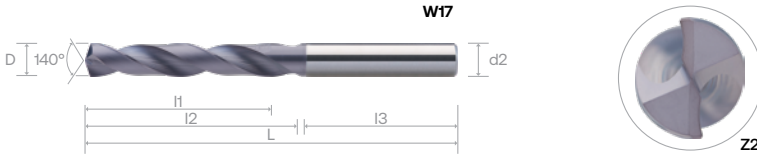
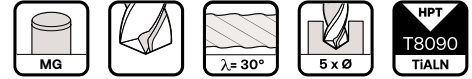

Order Number	Dimension (mm)						T8090	Order Number	Dimension (mm)						T8090
	D (m7)	I1	I2	I3	L	d2 (h6)			D (m7)	I1	I2	I3	L	d2 (h6)	
W17 0100	1	8		33	55	3	•	W17 0610	6.1			36	91	8	◦
W17 0110	1.1			33	55	3	◦	W17 0620	6.2			36	91	8	◦
W17 0120	1.2	12		33	55	3	•	W17 0630	6.3			36	91	8	◦
W17 0130	1.3			33	55	3	◦	W17 0640	6.4			36	91	8	◦
W17 0140	1.4			33	55	3	◦	W17 0650	6.5			36	91	8	◦
W17 0150	1.5			35	55	3	•	W17 0660	6.6			36	91	8	◦
W17 0160	1.6			35	55	3	◦	W17 0670	6.7			36	91	8	◦
W17 0170	1.7	16		35	55	3	•	W17 0680	6.8			36	91	8	•
W17 0180	1.8			35	55	3	•	W17 0690	6.9			36	91	8	◦
W17 0190	1.9			35	55	3	◦	W17 0700	7			36	91	8	◦
W17 0200	2			36	57	4	•	W17 0710	7.1	53		36	91	8	◦
W17 0210	2.1			36	57	4	•	W17 0720	7.2			36	91	8	◦
W17 0220	2.2			36	57	4	◦	W17 0730	7.3			36	91	8	◦
W17 0230	2.3			36	57	4	•	W17 0740	7.4			36	91	8	◦
W17 0240	2.4	21		36	57	4	◦	W17 0750	7.5			36	91	8	◦
W17 0250	2.5			36	57	4	•	W17 0760	7.6			36	91	8	◦
W17 0260	2.6			36	57	4	•	W17 0770	7.7			36	91	8	◦
W17 0270	2.7			36	57	4	•	W17 0780	7.8			36	91	8	◦
W17 0280	2.8			36	57	4	◦	W17 0790	7.9			36	91	8	◦
W17 0290	2.9			36	57	4	◦	W17 0800	8			36	91	8	◦
W17 0300	3			36	66	6	•	W17 0810	8.1			40	103	10	◦
W17 0310	3.1			36	66	6	•	W17 0820	8.2			40	103	10	◦
W17 0320	3.2			36	66	6	•	W17 0830	8.3			40	103	10	◦
W17 0330	3.3	28		36	66	6	•	W17 0840	8.4			40	103	10	◦
W17 0340	3.4			36	66	6	•	W17 0850	8.5			40	103	10	•
W17 0350	3.5			36	66	6	◦	W17 0860	8.6			40	103	10	◦
W17 0360	3.6			36	66	6	◦	W17 0870	8.7			40	103	10	◦
W17 0370	3.7			36	66	6	◦	W17 0880	8.8			40	103	10	◦
W17 0380	3.8			36	74	6	◦	W17 0890	8.9			40	103	10	◦
W17 0390	3.9			36	74	6	◦	W17 0900	9	61		40	103	10	◦
W17 0400	4			36	74	6	•	W17 0910	9.1			40	103	10	◦
W17 0410	4.1			36	74	6	◦	W17 0920	9.2			40	103	10	◦
W17 0420	4.2	36		36	74	6	•	W17 0930	9.3			40	103	10	◦
W17 0430	4.3			36	74	6	◦	W17 0940	9.4			40	103	10	◦
W17 0440	4.4			36	74	6	◦	W17 0950	9.5			40	103	10	◦
W17 0450	4.5			36	74	6	•	W17 0960	9.6			40	103	10	◦
W17 0460	4.6			36	74	6	◦	W17 0970	9.7			40	103	10	◦
W17 0470	4.7			36	74	6	◦	W17 0980	9.8			40	103	10	◦
W17 0480	4.8			36	82	6	•	W17 0990	9.9			40	103	10	◦
W17 0490	4.9			36	82	6	◦	W17 1000	10			40	103	10	◦
W17 0500	5			36	82	6	•	W17 1010	10.1			45	118	12	◦
W17 0510	5.1			36	82	6	•	W17 1020	10.2			45	118	12	◦
W17 0520	5.2			36	82	6	•	W17 1030	10.3			45	118	12	◦
W17 0530	5.3			36	82	6	◦	W17 1040	10.4			45	118	12	◦
W17 0540	5.4	44		36	82	6	◦	W17 1050	10.5			45	118	12	◦
W17 0550	5.5			36	82	6	◦	W17 1060	10.6	71		45	118	12	◦
W17 0560	5.6			36	82	6	◦	W17 1070	10.7			45	118	12	◦
W17 0570	5.7			36	82	6	◦	W17 1080	10.8			45	118	12	◦
W17 0580	5.8			36	82	6	•	W17 1090	10.9			45	118	12	◦
W17 0590	5.9			36	82	6	◦	W17 1100	11			45	118	12	◦
W17 0600	6			36	82	6	•	W17 1110	11.1			45	118	12	◦

cont'd ▶

Material Group | Material-Gruppe | Groupe Matière | Gruppo Materiali | 材质主类

N01
 N02
 N03
 K01
 K02
 P01
 P02
 P03
 M01
 M02
 S01
 S02
 S03
 H01
 H02
 O01
 O02

Cutting Parameter

458

NC SPOT
 DR ALU
 EZ LINE - DRILL
 DR NITCO
 DR VA
 DR-S
 DR MINI
 DR-LX
 DR 45 SB
 DR 60

EZ TWIST DRILLS - DIN 6537L - 5 x Ø

- VHM EZ Spiralbohrer nach DIN 6537L, 140° Spitzenwinkel, Schaft nach DIN 6535HA
- Punte elicoidali EZ a norma DIN 6537L, 5 x Ø, con angolo di punta 140°, codolo DIN 6535HA
- Forets hélicoïdaux EZ selon DIN 6537L - 5 x Ø, angle de pointe 140°, queue selon DIN 6535HA
- 整体硬质合金 EZ 钻头-相等于DIN 6537L- 5 x Ø 2刃-加工深度3xD, 顶角140°

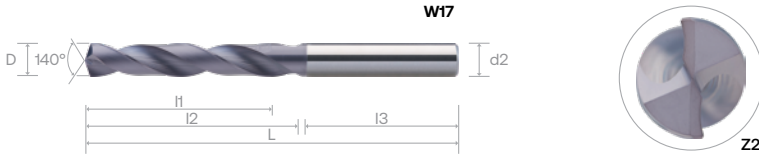

Order Number	Dimension (mm)						T8090	Order Number	Dimension (mm)						T8090
	D (m7)	I1	I2	I3	L	d2 (h6)			D (m7)	I1	I2	I3	L	d2 (h6)	
W17 1120	11.2	71		45	118	12	o								
W17 1130	11.3			45	118	12	o								
W17 1140	11.4			45	118	12	o								
W17 1150	11.5			45	118	12	o								
W17 1160	11.6			45	118	12	o								
W17 1170	11.7			45	118	12	o								
W17 1180	11.8			45	118	12	o								
W17 1190	11.9			45	118	12	o								
W17 1200	12			45	118	12	o								
W17 1220	12.2		77		45	124	14	o							
W17 1250	12.5			45	124	14	o								
W17 1270	12.7			45	124	14	o								
W17 1280	12.8			45	124	14	o								
W17 1300	13			45	124	14	o								
W17 1330	13.3			45	124	14	o								
W17 1350	13.5			45	124	14	o								
W17 1370	13.7			45	124	14	o								
W17 1380	13.8			45	124	14	o								
W17 1400	14			45	124	14	o								
W17 1420	14.2	83		48	133	16	o								
W17 1450	14.5			48	133	16	o								
W17 1480	14.8			48	133	16	o								
W17 1500	15			48	133	16	o								
W17 1510	15.1			48	133	16	o								
W17 1530	15.3			48	133	16	o								
W17 1550	15.5			48	133	16	o								
W17 1580	15.8			48	133	16	o								
W17 1600	16			48	133	16	o								

Material Group | Material-Gruppe | Groupe Matière | Gruppo Materiali | 材质主类

N01
N02
N03
K01
K02
P01
P02
P03
M01
M02
S01
S02
S03
H01
H02
O01
O02

Cutting Parameter

458

Recommended Cutting Data



Note: These recommended cutting data indicators are just for reference. They should be adjusted according to the different cutting condition



EZ Twist Drill - Point Angle 140°, 3 × D, 5 × D - W16, W17

Drilling	N				K				P							
Working Material	Wrought Aluminium		Cast Aluminium		Copper alloy		Grey Cast Iron		Ductile Cast Iron		Carbon Steel		Alloy Steel		Prehardened Steel	
Properties	Si < 9%		Si ≥ 9%		-		-		-		-		520 < Rm < 1200		35 ≤ HRC < 45	
D	Vc	fn	Vc	fn	Vc	fn	Vc	fn	Vc	fn	Vc	fn	Vc	fn	Vc	fn
1	150	0.019	130	0.018	100	0.018	75	0.020	60	0.012	80	0.021	65	0.015	35	0.016
2		0.040		0.038		0.038		0.042		0.025		0.043		0.032		
3		0.062		0.060		0.060		0.064		0.039		0.068		0.051		0.050
4		0.085		0.083		0.083		0.088		0.056		0.094		0.069		0.068
5		0.110		0.107		0.108		0.115		0.074		0.122		0.088		0.083
6		0.138		0.133		0.131		0.140		0.094		0.149		0.109		0.105
7		0.165		0.158		0.161		0.166		0.114		0.178		0.130		0.125
8		0.195		0.190		0.190		0.200		0.142		0.216		0.154		0.150
9		0.224		0.222		0.219		0.226		0.159		0.245		0.178		0.162
10		0.260		0.250		0.253		0.263		0.185		0.281		0.200		0.183
11		0.293		0.284		0.290		0.295		0.217		0.313		0.226		0.200
12		0.333		0.320		0.322		0.330		0.250		0.355		0.250		0.230
13		0.349		0.341		0.336		0.342		0.260		0.380		0.275		0.244
14		0.360		0.353		0.357		0.350		0.271		0.395		0.287		0.275
15		0.384		0.371		0.364		0.381		0.285		0.435		0.307		0.275
16		0.400		0.388		0.385		0.393		0.300		0.450		0.323		0.300

- NC SPOT
- DR ALU
- EZ LINE - DRILL
- DR NITCO
- DR VA
- DR-S
- DR MINI
- DR-LX
- DR 45 SB
- DR 60

DR NITICO OIL FEED TWIST DRILLS - DIN 6537K - 130° POINT ANGLE - 3 X Ø

- VHM DR NiTiCo Kühlkanalbohrer nach DIN 6537K 130° Spitzenwinkel, Schaft nach DIN 6535HA
- Punte elicoidali DR NiTiCo a norma DIN 6537K - 3 x Ø, con foro di lubrificazione, angolo di punta 130°, codolo DIN 6535HA
- Forets hélicoïdaux DR NiTiCo à trous d'huile selon DIN 6537K - 3 x Ø angle de pointe 130°, queue selon DIN 6535HA
- 整体硬质合金 DR NiTiCo 系列 内冷孔钻头-相等于DIN6537K 2刃-加工深度3xD, 柄部标准DIN6535HA, 顶角130°

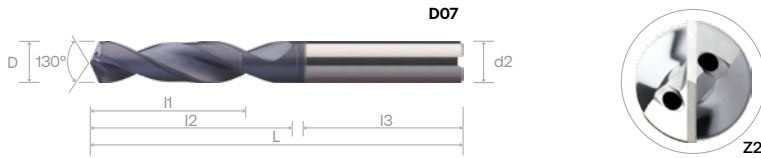
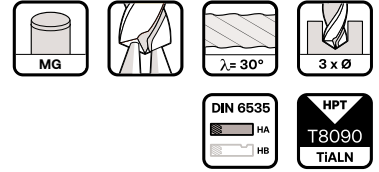

Order Number	Dimension (mm)						T8090	Order Number	Dimension (mm)						T8090
	D (m7)	I1	I2	I3	L	d2 (H6)			D (m7)	I1	I2	I3	L	d2 (H6)	
D07 0300 062 03	3	14	20	36	62	3	○	D07 0790	7.9	29	41	36	79	8	●
D07 0300 *	3		20	36	62	6	○	D07 0800	8		41	36	79	8	○
D07 0310 062 03	3.1		20	36	62	3	○	D07 0810 079 08 *	8.1		41	36	79	8	○
D07 0310 *	3.1		20	36	62	6	○	D07 0810 *	8.1		47	40	89	10	○
D07 0320 062 03	3.2		20	36	62	3	○	D07 0820 *	8.2		47	40	89	10	○
D07 0320 *	3.2		20	36	62	6	○	D07 0830 *	8.3		47	40	89	10	○
D07 0330 *	3.3		20	36	62	6	○	D07 0840 *	8.4		47	40	89	10	●
D07 0340 *	3.4		20	36	62	6	○	D07 0850 *	8.5		47	40	89	10	○
D07 0350 *	3.5		20	36	62	6	○	D07 0860 *	8.6		47	40	89	10	●
D07 0360 *	3.6		20	36	62	6	○	D07 0870 *	8.7		47	40	89	10	○
D07 0370 *	3.7	20	36	62	6	○	D07 0880 *	8.8	47	40	89	10	○		
D07 0380 *	3.8	17	24	36	66	6	●	D07 0890 *	8.9	47	40	89	10	○	
D07 0390 *	3.9		24	36	66	6	○	D07 0900 *	9	47	40	89	10	○	
D07 0400 066 04	4		24	36	66	4	●	D07 0910 *	9.1	47	40	89	10	○	
D07 0400 *	4		24	36	66	6	○	D07 0920 *	9.2	47	40	89	10	○	
D07 0410 066 04	4.1		24	36	66	4	●	D07 0930 *	9.3	47	40	89	10	○	
D07 0410 *	4.1		24	36	66	6	○	D07 0940 *	9.4	47	40	89	10	○	
D07 0420 066 04	4.2		24	36	66	4	●	D07 0950 *	9.5	47	40	89	10	○	
D07 0420 *	4.2		24	36	66	6	○	D07 0960 *	9.6	47	40	89	10	○	
D07 0430 *	4.3		24	36	66	6	●	D07 0970 *	9.7	47	40	89	10	○	
D07 0440 *	4.4		24	36	66	6	○	D07 0980 *	9.8	47	40	89	10	○	
D07 0450 *	4.5	20	24	36	66	6	○	D07 0990 *	9.9	47	40	89	10	●	
D07 0460 *	4.6		24	36	66	6	○	D07 1000 *	10	47	40	89	10	○	
D07 0470 *	4.7		24	36	66	6	○	D07 1020 *	10.2	55	45	102	12	○	
D07 0480 *	4.8		28	36	66	6	○	D07 1050 *	10.5	55	45	102	12	○	
D07 0490 *	4.9		28	36	66	6	○	D07 1080 *	10.8	55	45	102	12	●	
D07 0500 *	5		28	36	66	6	●	D07 1100 *	11	55	45	102	12	○	
D07 0510 *	5.1		28	36	66	6	●	D07 1120 *	11.2	55	45	102	12	●	
D07 0520 *	5.2		28	36	66	6	○	D07 1130 *	11.3	55	45	102	12	○	
D07 0530 *	5.3		28	36	66	6	●	D07 1150 *	11.5	55	45	102	12	○	
D07 0540 *	5.4		28	36	66	6	○	D07 1180 *	11.8	55	45	102	12	○	
D07 0550 *	5.5	24	28	36	66	6	○	D07 1200 *	12	55	45	102	12	○	
D07 0560 *	5.6		28	36	66	6	○	D07 1220 *	12.2	60	45	107	14	○	
D07 0570 *	5.7		28	36	66	6	○	D07 1250 *	12.5	60	45	107	14	○	
D07 0580 *	5.8		28	36	66	6	○	D07 1270 *	12.7	60	45	107	14	○	
D07 0590 *	5.9		28	36	66	6	●	D07 1280 *	12.8	60	45	107	14	○	
D07 0600 *	6		28	36	66	6	○	D07 1300 *	13	60	45	107	14	○	
D07 0610 066 06 *	6.1		28	36	66	6	○	D07 1330 *	13.3	60	45	107	14	○	
D07 0610 *	6.1		29	34	36	79	8	○	D07 1350 *	13.5	60	45	107	14	○
D07 0620 *	6.2			34	36	79	8	○	D07 1370 *	13.7	60	45	107	14	○
D07 0630 *	6.3			34	36	79	8	○	D07 1380 *	13.8	60	45	107	14	●
D07 0640 *	6.4	34		36	79	8	●	D07 1400 *	14	60	45	107	14	○	
D07 0650 *	6.5	34		36	79	8	○	D07 1450 *	14.5	65	48	115	16	○	
D07 0660 *	6.6	34		36	79	8	○	D07 1500 *	15	65	48	115	16	○	
D07 0670 *	6.7	34		36	79	8	●	D07 1530 *	15.3	65	48	115	16	○	
D07 0680 *	6.8	34		36	79	8	●	D07 1550 *	15.5	65	48	115	16	○	
D07 0690 *	6.9	34		36	79	8	●	D07 1580 *	15.8	65	48	115	16	○	
D07 0700 *	7	34		36	79	8	○	D07 1600 *	16	65	48	115	16	○	
D07 0710 *	7.1	29	41	36	79	8	○	D07 1650 *	16.5	73	48	123	18	○	
D07 0720 *	7.2		41	36	79	8	○	D07 1700 *	17	73	48	123	18	○	
D07 0730 *	7.3		41	36	79	8	○	D07 1750 *	17.5	73	48	123	18	○	
D07 0740 *	7.4		41	36	79	8	●	D07 1800 *	18	73	48	123	18	○	
D07 0750 *	7.5		41	36	79	8	○	D07 1850 *	18.5	79	50	131	20	○	
D07 0760 *	7.6		41	36	79	8	●	D07 1900 *	19	79	50	131	20	○	
D07 0770 *	7.7		41	36	79	8	○	D07 1950 *	19.5	79	50	131	20	○	
D07 0780 *	7.8		41	36	79	8	○	D07 2000	20	79	50	131	20	○	

* - DIN 6535

Material Group | Material-Gruppe | Groupe Matière | Gruppo Materiali | 材质主类

N01	N02	N03	K01	K02	P01	P02	P03	M01	M02	S01	S02	S03	H01	H02	O01	O02	Cutting Parameter
																	461

DR NITICO OIL FEED TWIST DRILLS - DIN 6537L - 130° POINT ANGLE - 5 X Ø

- VHM DR ALU Kühlkanalbohrer nach DIN 6537L, 130° Spitzenwinkel, Schaft nach DIN 6535HA
- Punta elicoidali DR ALU a norma DIN 6537L - 5 x Ø, con foro di lubrificazione, angolo di punta 130°, codolo DIN 6535HA
- Forets hélicoïdaux DR ALU à trous d'huile selon DIN 6537L - 5 x Ø, angle de pointe 130°, queue selon DIN 6535HA
- 整体硬质合金 DR ALU 系列 内冷孔钻头-相等于DIN6537L 2刃-加工深度5xD, 柄部标准DIN6535HA, 顶角130°

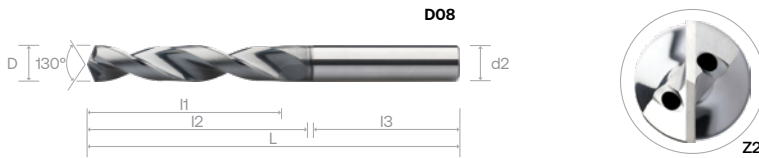
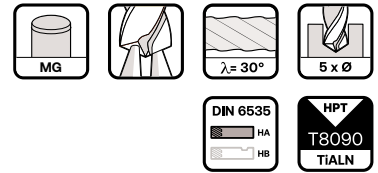

Order Number	Dimension (mm)						T8090	Order Number	Dimension (mm)						T8090
	D (m7)	I1	I2	I3	L	d2 (h6)			D (m7)	I1	I2	I3	L	d2 (h6)	
D08 0300 062 03	3	23	28	36	66	3	○	D08 0790	7.9	43	53	36	91	8	○
D08 0300 *	3		28	36	66	6	●	D08 0800	8		53	36	91	8	●
D08 0310 062 03	3.1		28	36	66	3	○	D08 0810 079 08 *	8.1		53	36	91	8	○
D08 0310 *	3.1		28	36	66	6	●	D08 0810 *	8.1		61	40	103	10	○
D08 0320 062 03	3.2		28	36	66	3	○	D08 0820 *	8.2		61	40	103	10	○
D08 0320 *	3.2		28	36	66	6	○	D08 0830 *	8.3		61	40	103	10	○
D08 0330 *	3.3		28	36	66	6	●	D08 0840 *	8.4		61	40	103	10	○
D08 0340 *	3.4		28	36	66	6	●	D08 0850 *	8.5		61	40	103	10	○
D08 0350 *	3.5		28	36	66	6	●	D08 0860 *	8.6		61	40	103	10	●
D08 0360 *	3.6		28	36	66	6	○	D08 0870 *	8.7		61	40	103	10	○
D08 0370 *	3.7	28	36	66	6	○	D08 0880 *	8.8	61	40	103	10	○		
D08 0380 *	3.8	29	36	36	74	6	○	D08 0890 *	8.9	61	40	103	10	○	
D08 0390 *	3.9		36	36	74	6	○	D08 0900 *	9	61	40	103	10	●	
D08 0400 066 04	4		36	36	74	4	○	D08 0910 *	9.1	61	40	103	10	●	
D08 0400 *	4		36	36	74	6	●	D08 0920 *	9.2	61	40	103	10	○	
D08 0410 066 04	4.1		36	36	74	4	○	D08 0930 *	9.3	61	40	103	10	○	
D08 0410 *	4.1		36	36	74	6	●	D08 0940 *	9.4	61	40	103	10	○	
D08 0420 066 04	4.2		36	36	74	4	○	D08 0950 *	9.5	61	40	103	10	●	
D08 0420 *	4.2		36	36	74	6	○	D08 0960 *	9.6	61	40	103	10	●	
D08 0430 *	4.3		36	36	74	6	●	D08 0970 *	9.7	61	40	103	10	○	
D08 0440 *	4.4		36	36	74	6	○	D08 0980 *	9.8	61	40	103	10	○	
D08 0450 *	4.5	36	36	74	6	○	D08 0990 *	9.9	61	40	103	10	○		
D08 0460 *	4.6	36	36	74	6	●	D08 1000 *	10	61	40	103	10	●		
D08 0470 *	4.7	35	36	36	74	6	●	D08 1020 *	10.2	56	71	45	118	12	○
D08 0480 *	4.8		44	36	82	6	○	D08 1050 *	10.5		71	45	118	12	○
D08 0490 *	4.9		44	36	82	6	○	D08 1080 *	10.8		71	45	118	12	○
D08 0500 *	5		44	36	82	6	●	D08 1100 *	11		71	45	118	12	○
D08 0510 *	5.1		44	36	82	6	●	D08 1120 *	11.2		71	45	118	12	●
D08 0520 *	5.2		44	36	82	6	●	D08 1130 *	11.3		71	45	118	12	●
D08 0530 *	5.3		44	36	82	6	●	D08 1150 *	11.5		71	45	118	12	●
D08 0540 *	5.4		44	36	82	6	○	D08 1180 *	11.8		71	45	118	12	○
D08 0550 *	5.5		44	36	82	6	○	D08 1200 *	12		71	45	118	12	●
D08 0560 *	5.6		44	36	82	6	●	D08 1220 *	12.2		77	45	124	14	○
D08 0570 *	5.7	44	36	82	6	○	D08 1250 *	12.5	77	45	124	14	○		
D08 0580 *	5.8	44	36	82	6	○	D08 1270 *	12.7	77	45	124	14	○		
D08 0590 *	5.9	44	36	82	6	○	D08 1280 *	12.8	77	45	124	14	○		
D08 0600 *	6	44	36	82	6	●	D08 1300 *	13	60	77	45	124	14	●	
D08 0610 066 06 *	6.1	44	36	82	6	○	D08 1330 *	13.3		77	45	124	14	○	
D08 0610 *	6.1	53	36	91	8	○	D08 1350 *	13.5		77	45	124	14	●	
D08 0620 *	6.2	53	36	91	8	●	D08 1370 *	13.7		77	45	124	14	○	
D08 0630 *	6.3	53	36	91	8	○	D08 1380 *	13.8		77	45	124	14	○	
D08 0640 *	6.4	53	36	91	8	○	D08 1400 *	14		77	45	124	14	●	
D08 0650 *	6.5	53	36	91	8	●	D08 1450 *	14.5		83	48	133	16	○	
D08 0660 *	6.6	53	36	91	8	○	D08 1500 *	15		83	48	133	16	○	
D08 0670 *	6.7	53	36	91	8	○	D08 1530 *	15.3		83	48	133	16	○	
D08 0680 *	6.8	53	36	91	8	○	D08 1550 *	15.5		83	48	133	16	○	
D08 0690 *	6.9	53	36	91	8	●	D08 1580 *	15.8	83	48	133	16	○		
D08 0700 *	7	43	53	36	91	8	○	D08 1600 *	16	83	48	133	16	○	
D08 0710 *	7.1		53	36	91	8	○	D08 1650 *	16.5	93	48	143	18	○	
D08 0720 *	7.2		53	36	91	8	○	D08 1700 *	17	71	93	48	143	18	○
D08 0730 *	7.3		53	36	91	8	○	D08 1750 *	17.5		93	48	143	18	○
D08 0740 *	7.4		53	36	91	8	○	D08 1800 *	18	93	48	143	18	○	
D08 0750 *	7.5		53	36	91	8	○	D08 1850 *	18.5	77	101	50	153	20	○
D08 0760 *	7.6		53	36	91	8	○	D08 1900 *	19		101	50	153	20	○
D08 0770 *	7.7		53	36	91	8	○	D08 1950 *	19.5		101	50	153	20	○
D08 0780 *	7.8		53	36	91	8	○	D08 2000	20		101	50	153	20	○

* - DIN 6535

Material Group | Material-Gruppe | Groupe Matière | Gruppo Materiali | 材质主类



Cutting Parameter



NC SPOT
DR ALU
EZ LINE - DRILL
DR NITICO
DR VA
DR-S
DR MINI
DR-LX
DR 45 SB
DR 60

Recommended Cutting Data



Note: These recommended cutting data indicators are just for reference. They should be adjusted according to the different cutting condition



DR NiTiCo Oil Feed Twist Drills, 3xD & 5xD, 2 Flutes - D07, D08



Drilling	M		S	
Working Material	Stainless Steel		Titanium Alloy	
Properties	High Machinability		-	
D	Vc	fn	Vc	fn
3	65	0.045	40	0.063
4		0.067		0.080
5		0.086		0.080
6		0.110		0.100
7		0.130		0.113
8		0.160		0.125
9		0.175		0.143
10		0.195		0.160
11		0.220		0.160
12		0.245		0.160
13		0.255		0.170
14		0.272		0.180
15		0.285		0.190
16		0.310		0.200
17		0.315		0.213
18		0.330		0.226
19		0.330		0.239
20		0.330		0.250

NC SPOT
DR ALU
EZ LINE - DRILL
DR NITICO
DR VA
DR-S
DR MINI
DR-LX
DR 45 SB
DR 60

FEATURES & BENEFITS

DR VA

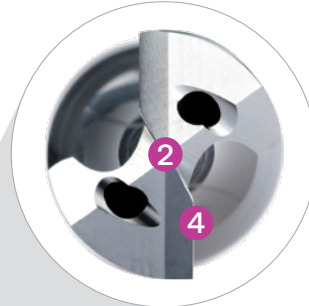

1 Radius Gash Design

- Edge protection for that particular area
- Generate shorter chip for better chip evacuation

3 Highly Polished Flutes

Ensures fast, efficient chips evacuation and drastically reduces built-up edge

5 Regrind and honing friendly

2 X-Thinning

Better self-centering on initial cutting

4 Straight Edge Profile

Shorter chip and reinforced cutting edge

6 Suitable for Material Groups





1. Radius-Spannutengeometrie
Kantenschutz für diesen speziellen Bereich
Erzeugt kleinere Späne die besseren Spänefluß
2. X-Ausspitzung
Bessere Selbstzentrierung beim Anschnitt
3. Polierte Schneiden
Sorgt für schnellen effizienten Spänefluß und reduziert die Bildung von Aufbauschnitten
4. Gerades Kantenprofil
Kürzerer Span und verstärkte Schneidkante
5. Leicht nachzuschleifen
6. Geeignet für die Materialgruppen P, M, S



1. 半径沟槽设计
该特定区域的边缘保护。
产生更短的碎屑, 以实现更好的排屑。
2. X 变薄
初始切割时更好的自定心能力。
3. 高度抛光的排屑槽
确保快速、高效的排屑和极大减少铁屑堆积。
4. 直边轮廓
较短的碎屑和强化的切削刃。
5. 易于研磨和珩磨
6. 适用于材料 P、M、S



1. Struttura sgrossatura raggio
Protezione angoli per quell'area specifica
Genera trucioli più piccoli per una migliore evacuazione
2. X-assottigliamento
Miglior autocentraggio al taglio iniziale
3. Scanalature altamente levigate
Assicura una evacuazione rapida ed efficace e riduce enormemente
4. Profilo dritto
Trucioli più corti e angolo di taglio rinforzato
5. Riaffilatura e rifinitura
6. Adatto per il materiale P, M, S



1. Conception des goujures rayonnées
Protection des arêtes pour cette zone en particulier
Génère des copeaux plus courts pour une meilleure évacuation
2. Amincissement en X
Meilleur auto-centrage à l'attaque du perçage
3. Goujures hautement polies
Garantit une évacuation des copeaux rapide et efficace et réduit radicalement
4. Profil d'arête droite
Copeaux plus courts et arête de coupe renforcée
5. Compatible avec le réaffûtage et le pierrage
6. Adapté aux matériaux P, M, S

DR VA OIL FEED TWIST DRILLS - DIN 6537K - 140° POINT ANGLE - 3 X Ø

- VHM DR VA Kühlkanalbohrer nach DIN 6537K, 140° Spitzenwinkel, Schaft nach DIN 6535HA
- Punta elicoidali DR 45 norma DIN 6537K - 3 x Ø con foro di lubrificazione, angolo di punta 140°, codolo DIN 6535HA
- Forets hélicoïdaux DR VA à trous d'huile selon DIN 6537K - 3 x Ø, angle de pointe 140°, queue selon DIN 6535HA
- 整体硬质合金DRVA 系列 内冷孔钻头-相等于DIN6537K2刃-加工深度3xD, 柄部标准DIN6535HA, 顶角140°

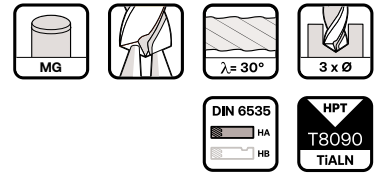

Order Number	Dimension (mm)						T8090	Order Number	Dimension (mm)						T8090
	D (m7)	I1	I2	I3	L	d2 (h6)			D (m7)	I1	I2	I3	L	d2 (h6)	
C73 0300 062 03	3	14	20	36	62	3	◦	C73 0790	7.9	29	41	36	79	8	◦
C73 0300 *	3		20	36	62	6	•	C73 0800	8		41	36	79	8	◦
C73 0310 062 03	3.1		20	36	62	3	◦	C73 0810 079 08 *	8.1		41	36	79	8	◦
C73 0310 *	3.1		20	36	62	6	◦	C73 0810 *	8.1		47	40	89	10	◦
C73 0320 062 03	3.2		20	36	62	3	◦	C73 0820 *	8.2		47	40	89	10	◦
C73 0320 *	3.2		20	36	62	6	•	C73 0830 *	8.3		47	40	89	10	◦
C73 0330 *	3.3		20	36	62	6	◦	C73 0840 *	8.4		47	40	89	10	◦
C73 0340 *	3.4		20	36	62	6	•	C73 0850 *	8.5		47	40	89	10	◦
C73 0350 *	3.5		20	36	62	6	•	C73 0860 *	8.6		47	40	89	10	•
C73 0360 *	3.6		20	36	62	6	◦	C73 0870 *	8.7		47	40	89	10	•
C73 0370 *	3.7	20	36	62	6	◦	C73 0880 *	8.8	47	40	89	10	•		
C73 0380 *	3.8	17	24	36	66	6	◦	C73 0890 *	8.9	47	40	89	10	◦	
C73 0390 *	3.9		24	36	66	6	◦	C73 0900 *	9	47	40	89	10	◦	
C73 0400 066 04	4		24	36	66	4	◦	C73 0910 *	9.1	47	40	89	10	◦	
C73 0400 *	4		24	36	66	6	•	C73 0920 *	9.2	47	40	89	10	◦	
C73 0410 066 04	4.1		24	36	66	4	◦	C73 0930 *	9.3	47	40	89	10	•	
C73 0410 *	4.1		24	36	66	6	◦	C73 0940 *	9.4	47	40	89	10	•	
C73 0420 066 04	4.2		24	36	66	4	◦	C73 0950 *	9.5	47	40	89	10	◦	
C73 0420 *	4.2		24	36	66	6	•	C73 0960 *	9.6	47	40	89	10	•	
C73 0430 *	4.3		24	36	66	6	•	C73 0970 *	9.7	47	40	89	10	◦	
C73 0440 *	4.4		24	36	66	6	◦	C73 0980 *	9.8	47	40	89	10	◦	
C73 0450 *	4.5	24	36	66	6	◦	C73 0990 *	9.9	47	40	89	10	•		
C73 0460 *	4.6	20	24	36	66	6	◦	C73 1000 *	10	47	40	89	10	•	
C73 0470 *	4.7		24	36	66	6	•	C73 1020 *	10.2	40	55	45	102	12	◦
C73 0480 *	4.8		28	36	66	6	•	C73 1050 *	10.5		55	45	102	12	•
C73 0490 *	4.9		28	36	66	6	◦	C73 1080 *	10.8		55	45	102	12	◦
C73 0500 *	5		28	36	66	6	•	C73 1100 *	11		55	45	102	12	•
C73 0510 *	5.1		28	36	66	6	•	C73 1120 *	11.2		55	45	102	12	◦
C73 0520 *	5.2		28	36	66	6	•	C73 1130 *	11.3		55	45	102	12	◦
C73 0530 *	5.3		28	36	66	6	◦	C73 1150 *	11.5		55	45	102	12	•
C73 0540 *	5.4		28	36	66	6	◦	C73 1180 *	11.8		55	45	102	12	•
C73 0550 *	5.5		28	36	66	6	◦	C73 1200 *	12		55	45	102	12	•
C73 0560 *	5.6	28	36	66	6	◦	C73 1220 *	12.2	60		45	107	14	•	
C73 0570 *	5.7	28	36	66	6	◦	C73 1250 *	12.5	60	45	107	14	◦		
C73 0580 *	5.8	28	36	66	6	◦	C73 1270 *	12.7	60	45	107	14	◦		
C73 0590 *	5.9	28	36	66	6	◦	C73 1280 *	12.8	60	45	107	14	◦		
C73 0600 *	6	28	36	66	6	•	C73 1300 *	13	60	45	107	14	•		
C73 0610 066 06 *	6.1	28	36	66	6	◦	C73 1330 *	13.3	60	45	107	14	◦		
C73 0610 *	6.1	24	34	36	79	8	•	C73 1350 *	13.5	60	45	107	14	•	
C73 0620 *	6.2		34	36	79	8	•	C73 1370 *	13.7	60	45	107	14	◦	
C73 0630 *	6.3		34	36	79	8	◦	C73 1380 *	13.8	60	45	107	14	•	
C73 0640 *	6.4		34	36	79	8	◦	C73 1400 *	14	60	45	107	14	◦	
C73 0650 *	6.5		34	36	79	8	•	C73 1450 *	14.5	65	48	115	16	•	
C73 0660 *	6.6		34	36	79	8	•	C73 1500 *	15	65	48	115	16	◦	
C73 0670 *	6.7		34	36	79	8	◦	C73 1530 *	15.3	65	48	115	16	◦	
C73 0680 *	6.8		34	36	79	8	•	C73 1550 *	15.5	65	48	115	16	◦	
C73 0690 *	6.9		34	36	79	8	•	C73 1580 *	15.8	65	48	115	16	•	
C73 0700 *	7		34	36	79	8	•	C73 1600 *	16	65	48	115	16	•	
C73 0710 *	7.1	29	41	36	79	8	•	C73 1650 *	16.5	73	48	123	18	◦	
C73 0720 *	7.2		41	36	79	8	◦	C73 1700 *	17	73	48	123	18	•	
C73 0730 *	7.3		41	36	79	8	◦	C73 1750 *	17.5	73	48	123	18	◦	
C73 0740 *	7.4		41	36	79	8	◦	C73 1800 *	18	73	48	123	18	◦	
C73 0750 *	7.5		41	36	79	8	•	C73 1850 *	18.5	79	50	131	20	◦	
C73 0760 *	7.6		41	36	79	8	◦	C73 1900 *	19	79	50	131	20	◦	
C73 0770 *	7.7		41	36	79	8	◦	C73 1950 *	19.5	79	50	131	20	◦	
C73 0780 *	7.8		41	36	79	8	◦	C73 2000	20	79	50	131	20	•	

* - DIN 6535

Material Group | Material-Gruppe | Groupe Matière | Gruppo Materiali | 材质主类

N01	N02	N03	K01	K02	P01	P02	P03	M01	M02	S01	S02	S03	H01	H02	O01	O02
-----	-----	-----	-----	-----	-----	-----	-----	-----	-----	-----	-----	-----	-----	-----	-----	-----

Cutting Parameter

466

DR VA OIL FEED TWIST DRILLS - DIN 6537L - 140° POINT ANGLE - 5 X Ø

- VHM DR VA Kühlkanalbohrer nach DIN 6537L, 140° Spitzenwinkel, Schaft nach DIN 6535HA
- Punte elicoidali DR VA a norma DIN 6537L- 5 x Ø, con foro di lubrificazione, angolo di punta 140°, codolo DIN 6535HA
- Forets hélicoïdaux DR VA à trous d'huile selon DIN 6537L - 5 x Ø, angle de pointe 140°, queue selon DIN 6535HA
- 整体硬质合金 DR V A 系列 内冷孔钻头-相等于DIN6537L 2刃-加工深度5xD, 柄部标准DIN6535HA, 顶角140°

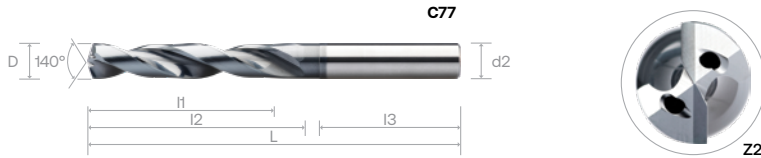
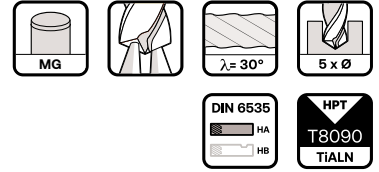

Order Number	Dimension (mm)						T8090	Order Number	Dimension (mm)						T8090		
	D (m7)	I1	I2	I3	L	d2 (h6)			D (m7)	I1	I2	I3	L	d2 (h6)			
C77 0300 062 03	3	23	28	36	66	3	o	C77 0790	*	7.9	43	53	36	91	8	o	
C77 0300	*		3	28	36	66	6	•	C77 0800	*		8	53	36	91	8	•
C77 0310 062 03	3.1		28	36	66	3	o	C77 0810 079 08	*	8.1		53	36	91	8	•	
C77 0310	*		3.1	28	36	66	6	•	C77 0810	*		8.1	61	40	103	10	•
C77 0320 062 03	3.2		28	36	66	3	o	C77 0820	*	8.2		61	40	103	10	•	
C77 0320	*		3.2	28	36	66	6	•	C77 0830	*		8.3	61	40	103	10	o
C77 0330	*		3.3	28	36	66	6	•	C77 0840	*		8.4	61	40	103	10	•
C77 0340	*		3.4	28	36	66	6	o	C77 0850	*		8.5	61	40	103	10	•
C77 0350	*		3.5	28	36	66	6	•	C77 0860	*		8.6	61	40	103	10	o
C77 0360	*		3.6	28	36	66	6	o	C77 0870	*		8.7	61	40	103	10	•
C77 0370	*	3.7	28	36	66	6	•	C77 0880	*	8.8	61	40	103	10	o		
C77 0380	*	3.8	36	36	74	6	o	C77 0890	*	8.9	61	40	103	10	o		
C77 0390	*	3.9	36	36	74	6	o	C77 0900	*	9	49	61	40	103	10	•	
C77 0400 066 04	4	29	36	36	74	4	o	C77 0910	*	9.1	61	40	103	10	o		
C77 0400	*		4	36	36	74	6	•	C77 0920	*	9.2	61	40	103	10	o	
C77 0410 066 04	4.1		36	36	74	4	o	C77 0930	*	9.3	61	40	103	10	o		
C77 0410	*		4.1	36	36	74	6	o	C77 0940	*	9.4	61	40	103	10	•	
C77 0420 066 04	4.2		36	36	74	4	o	C77 0950	*	9.5	61	40	103	10	•		
C77 0420	*		4.2	36	36	74	6	•	C77 0960	*	9.6	61	40	103	10	o	
C77 0430	*		4.3	36	36	74	6	•	C77 0970	*	9.7	61	40	103	10	o	
C77 0440	*		4.4	36	36	74	6	o	C77 0980	*	9.8	61	40	103	10	•	
C77 0450	*		4.5	36	36	74	6	o	C77 0990	*	9.9	61	40	103	10	•	
C77 0460	*		4.6	36	36	74	6	o	C77 1000	*	10	61	40	103	10	o	
C77 0470	*	4.7	36	36	74	6	•	C77 1020	*	10.2	71	45	118	12	o		
C77 0480	*	4.8	44	36	82	6	•	C77 1050	*	10.5	71	45	118	12	•		
C77 0490	*	4.9	44	36	82	6	•	C77 1080	*	10.8	71	45	118	12	o		
C77 0500	*	5	44	36	82	6	•	C77 1100	*	11	71	45	118	12	o		
C77 0510	*	5.1	44	36	82	6	•	C77 1120	*	11.2	71	45	118	12	o		
C77 0520	*	5.2	44	36	82	6	•	C77 1130	*	11.3	71	45	118	12	•		
C77 0530	*	5.3	44	36	82	6	o	C77 1150	*	11.5	71	45	118	12	•		
C77 0540	*	5.4	44	36	82	6	o	C77 1180	*	11.8	71	45	118	12	•		
C77 0550	*	5.5	44	36	82	6	o	C77 1200	*	12	71	45	118	12	•		
C77 0560	*	5.6	44	36	82	6	o	C77 1220	*	12.2	77	45	124	14	•		
C77 0570	*	5.7	44	36	82	6	o	C77 1250	*	12.5	77	45	124	14	o		
C77 0580	*	5.8	44	36	82	6	•	C77 1270	*	12.7	77	45	124	14	o		
C77 0590	*	5.9	44	36	82	6	o	C77 1280	*	12.8	77	45	124	14	o		
C77 0600	*	6	44	36	82	6	•	C77 1300	*	13	77	45	124	14	o		
C77 0610 066 06	6.1	35	44	36	82	6	o	C77 1330	*	13.3	77	45	124	14	o		
C77 0610	*		6.1	53	36	91	8	•	C77 1350	*	13.5	77	45	124	14	o	
C77 0620	*		6.2	53	36	91	8	•	C77 1370	*	13.7	77	45	124	14	o	
C77 0630	*		6.3	53	36	91	8	•	C77 1380	*	13.8	77	45	124	14	•	
C77 0640	*		6.4	53	36	91	8	o	C77 1400	*	14	77	45	124	14	•	
C77 0650	*		6.5	53	36	91	8	o	C77 1450	*	14.5	83	48	133	16	•	
C77 0660	*		6.6	53	36	91	8	•	C77 1500	*	15	83	48	133	16	o	
C77 0670	*		6.7	53	36	91	8	o	C77 1530	*	15.3	83	48	133	16	o	
C77 0680	*		6.8	53	36	91	8	•	C77 1550	*	15.5	83	48	133	16	o	
C77 0690	*		6.9	53	36	91	8	o	C77 1580	*	15.8	83	48	133	16	o	
C77 0700	*	7	53	36	91	8	•	C77 1600	*	16	83	48	133	16	o		
C77 0710	*	7.1	53	36	91	8	o	C77 1650	*	16.5	93	48	143	18	o		
C77 0720	*	7.2	53	36	91	8	o	C77 1700	*	17	93	48	143	18	•		
C77 0730	*	7.3	53	36	91	8	o	C77 1750	*	17.5	93	48	143	18	o		
C77 0740	*	7.4	53	36	91	8	•	C77 1800	*	18	93	48	143	18	o		
C77 0750	*	7.5	53	36	91	8	o	C77 1850	*	18.5	101	50	153	20	o		
C77 0760	*	7.6	53	36	91	8	o	C77 1900	*	19	101	50	153	20	o		
C77 0770	*	7.7	53	36	91	8	o	C77 1950	*	19.5	101	50	153	20	o		
C77 0780	*	7.8	53	36	91	8	•	C77 2000	*	20	101	50	153	20	o		

* - DIN 6535

Material Group | Material-Gruppe | Groupe Matière | Gruppo Materiali | 材质主类

N01	N02	N03	K01	K02	P01	P02	P03	M01	M02	S01	S02	S03	H01	H02	O01	O02	Cutting Parameter
																	466

Recommended Cutting Data



Note: These recommended cutting data indicators are just for reference. They should be adjusted according to the different cutting condition



DR VA Oil Feed Twist Drills, 3xD & 5xD, 2 Flutes - C73, C77

Drilling	M				S	
Working Material	Stainless Steel		Stainless Steel		Nickel Alloy	
Properties	High Machinability		Low Machinability		-	
D	Vc	fn	Vc	fn	Vc	fn
3	80	0.045	55	0.042	40	0.030
4		0.067		0.060		0.040
5		0.086		0.080		0.052
6		0.110		0.102		0.062
7		0.130		0.120		0.078
8		0.160		0.150		0.092
9		0.175		0.170		0.105
10		0.195		0.188		0.120
11		0.220		0.210		0.132
12		0.245		0.242		0.155
13		0.252		0.249		0.162
14		0.258		0.255		0.168
15		0.280		0.275		0.172
16		0.292		0.285		0.185
17		0.307		0.290		0.186
18		0.308		0.303		0.187
19		0.320		0.310		0.192
20		0.330		0.325		0.200

NC SPOT
DR ALU
EZ LINE -
DRILL
DR NITCO
DR VA
DR-S
DR MINI
DR-LX
DR 45 SB
DR 60

FEATURES & BENEFITS

DR-S

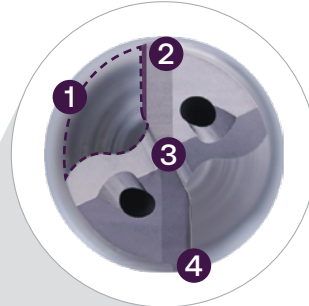

1 Wider Chip Pocket

Enhances and smoother chip evacuation

2 Straight Edge Profile

Shorter chip and reinforced cutting edge

3 Bigger K-Value

Suitable for higher feed rate and enhances tool durability

4 Corner Chamfer Edge

Ideal for cast iron and better surface finishing

5 Versatile

Suitable for 5 material groups





1. Größere Spantasche
Verbesserter problemloser Spänefluß
2. Gerades Schneidkantenprofil
Kürzere Späne und verstärkte Schneidkanten
3. Größere K-Ausprägung
für höhere Vorschubgeschwindigkeit und verbesserte die Haltbarkeit des Werkzeugs
4. Schneideckenfase
Ideal für Gussbearbeitung und bessere Oberflächengüte
5. Vielseitig
Geeignet für 5 Materialgruppen



1. 更宽的碎屑袋
增强和更顺畅的排屑。
2. 直边轮廓
较短的碎屑和强化的切削刃。
3. 更大的 K 值
适用于较高的进料速率和提高刀具耐用性。
4. 角倒角边
铸铁和更好的表面处理的理想选择。
5. 多功能
适用于 5 个材料组







1. Tasca trucioli più ampia
Migliora e semplifica l'evacuazione dei trucioli
2. Profilo dritto
Trucioli più corti e angolo di taglio rinforzato
3. Valore K più grande
Adatto per velocità di avanzamento più grandi e migliora la durata dello strumento
4. Tagliente di smusso
Ideale per ghisa e migliore finitura superficiale
5. Versatile
Adatto per gruppi di 5 materiali



1. Récupérateur de copeaux plus large
Évacuation des copeaux plus facile et plus fluide
2. Profil d'arête droite
Copeaux plus courts et arête tranchante renforcée
3. Coefficient K supérieur
Adapté pour un débit plus élevé et améliore la durabilité de l'outil
4. Arête chanfrein de coin
Idéal pour la fonte et meilleure finition de surface
5. Polyvalent
Adapté au 5 groupes de matériaux

DR-S TWIST DRILLS - DIN 6537K - 3 X Ø

-  VHM DR-S Spiralbohrer nach DIN 6537K, 140° Spitzenwinkel, Schaft nach DIN 6535HA
-  Punta elicoidale DR-S a norma DIN 6537K, 3 x ø, angolo di punta 140°, codolo DIN 6535HA
-  Forets hélicoïdaux DR-S selon DIN 6537K - 3 x Ø, angle de pointe 140°, queue selon DIN 6535HA
-  整体硬质合金 DR-S 系列 钻头-相等于DIN6537K-加工深度3xD, 柄部标准DIN6535HA, 油料麻花钻-相等于2刀, 柄部标准DIN6535HA, 顶角140°

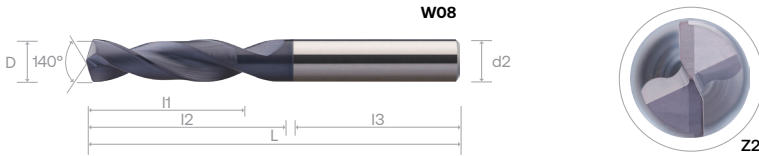
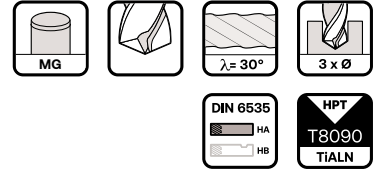

Order Number	Dimension (mm)						T8090	Order Number	Dimension (mm)						T8090
	D (m7)	I1	I2	I3	L	d2 (h6)			D (m7)	I1	I2	I3	L	d2 (h6)	
W08 0300 *	3	14	20	36	62	6	•	W08 0850 *	8.5	35	47	40	89	10	•
W08 0310 *	3.1		20	36	62	6	•	W08 0860 *	8.6		47	40	89	10	•
W08 0320 *	3.2		20	36	62	6	•	W08 0870 *	8.7		47	40	89	10	•
W08 0330 *	3.3		20	36	62	6	•	W08 0880 *	8.8		47	40	89	10	•
W08 0340 *	3.4		20	36	62	6	•	W08 0890 *	8.9		47	40	89	10	•
W08 0350 *	3.5		20	36	62	6	•	W08 0900 *	9		47	40	89	10	•
W08 0360 *	3.6		20	36	62	6	•	W08 0910 *	9.1		47	40	89	10	•
W08 0370 *	3.7		20	36	62	6	•	W08 0920 *	9.2		47	40	89	10	•
W08 0380 *	3.8		24	36	66	6	•	W08 0930 *	9.3		47	40	89	10	•
W08 0390 *	3.9		24	36	66	6	•	W08 0940 *	9.4		47	40	89	10	•
W08 0400 *	4	24	36	66	6	•	W08 0950 *	9.5	47	40	89	10	•		
W08 0410 *	4.1	24	36	66	6	•	W08 0960 *	9.6	47	40	89	10	•		
W08 0420 *	4.2	17	24	36	66	6	•	W08 0970 *	9.7	47	40	89	10	•	
W08 0430 *	4.3		24	36	66	6	•	W08 0980 *	9.8	47	40	89	10	•	
W08 0440 *	4.4		24	36	66	6	•	W08 0990 *	9.9	47	40	89	10	•	
W08 0450 *	4.5		24	36	66	6	•	W08 1000 *	10	47	40	89	10	•	
W08 0460 *	4.6		24	36	66	6	•	W08 1010 *	10.1	55	45	102	12	•	
W08 0470 *	4.7		24	36	66	6	•	W08 1020 *	10.2	55	45	102	12	•	
W08 0480 *	4.8		28	36	66	6	•	W08 1030 *	10.3	55	45	102	12	•	
W08 0490 *	4.9		28	36	66	6	•	W08 1040 *	10.4	55	45	102	12	•	
W08 0500 *	5		28	36	66	6	•	W08 1050 *	10.5	55	45	102	12	•	
W08 0510 *	5.1		28	36	66	6	•	W08 1060 *	10.6	55	45	102	12	•	
W08 0520 *	5.2	20	28	36	66	6	•	W08 1070 *	10.7	55	45	102	12	•	
W08 0530 *	5.3		28	36	66	6	•	W08 1080 *	10.8	55	45	102	12	•	
W08 0540 *	5.4		28	36	66	6	•	W08 1090 *	10.9	55	45	102	12	•	
W08 0550 *	5.5		28	36	66	6	•	W08 1100 *	11	55	45	102	12	•	
W08 0560 *	5.6		28	36	66	6	•	W08 1110 *	11.1	55	45	102	12	•	
W08 0570 *	5.7		28	36	66	6	•	W08 1120 *	11.2	55	45	102	12	•	
W08 0580 *	5.8		28	36	66	6	•	W08 1130 *	11.3	55	45	102	12	•	
W08 0590 *	5.9		28	36	66	6	•	W08 1140 *	11.4	55	45	102	12	•	
W08 0600 *	6		28	36	66	6	•	W08 1150 *	11.5	55	45	102	12	•	
W08 0610 *	6.1		34	36	79	8	•	W08 1160 *	11.6	55	45	102	12	•	
W08 0620 *	6.2	24	34	36	79	8	•	W08 1170 *	11.7	55	45	102	12	•	
W08 0630 *	6.3		34	36	79	8	•	W08 1180 *	11.8	55	45	102	12	•	
W08 0640 *	6.4		34	36	79	8	•	W08 1190 *	11.9	55	45	102	12	•	
W08 0650 *	6.5		34	36	79	8	•	W08 1200 *	12	55	45	102	12	•	
W08 0660 *	6.6		34	36	79	8	•	W08 1250 *	12.5	60	45	107	14	•	
W08 0670 *	6.7		34	36	79	8	•	W08 1270 *	12.7	60	45	107	14	•	
W08 0680 *	6.8		34	36	79	8	•	W08 1300 *	13	60	45	107	14	•	
W08 0690 *	6.9		34	36	79	8	•	W08 1350 *	13.5	60	45	107	14	•	
W08 0700 *	7.0		34	36	79	8	•	W08 1370 *	13.7	60	45	107	14	•	
W08 0710 *	7.1		41	36	79	8	•	W08 1400 *	14	60	45	107	14	•	
W08 0720 *	7.2	41	36	79	8	•	W08 1450 *	14.5	65	48	115	16	•		
W08 0730 *	7.3	41	36	79	8	•	W08 1500 *	15	65	48	115	16	•		
W08 0740 *	7.4	41	36	79	8	•	W08 1550 *	15.5	65	48	115	16	•		
W08 0750 *	7.5	41	36	79	8	•	W08 1600 *	16	65	48	115	16	•		
W08 0760 *	7.6	41	36	79	8	•	W08 1650 *	16.5	73	48	123	18	•		
W08 0770 *	7.7	41	36	79	8	•	W08 1700 *	17	73	48	123	18	•		
W08 0780 *	7.8	41	36	79	8	•	W08 1750 *	17.5	73	48	123	18	•		
W08 0790 *	7.9	41	36	79	8	•	W08 1800 *	18	73	48	123	18	•		
W08 0800 *	8.0	41	36	79	8	•	W08 1850 *	18.5	79	50	131	20	•		
W08 0810 *	8.1	47	40	89	10	•	W08 1900 *	19	79	50	131	20	•		
W08 0820 *	8.2	35	47	40	89	10	•	W08 1950 *	19.5	79	50	131	20	•	
W08 0830 *	8.3		47	40	89	10	•	W08 2000 *	20	79	50	131	20	•	
W08 0840 *	8.4		47	40	89	10	•								

* - DIN 6535

Material Group | Material-Gruppe | Groupe Matière | Gruppo Materiali | 材质主类

N01	N02	N03	K01	K02	P01	P02	P03	M01	M02	S01	S02	S03	H01	H02	O01	O02	Cutting Parameter
○	○	○	●	●	●	●	●	○	○	●	●						475 - 476

DR-S TWIST DRILLS - DIN 6537L - 5 X Ø

- VHM DR-S Spiralbohrer nach DIN 6537L, 140° Spitzenwinkel, Schaft nach DIN 6535HA
- Punte elicoidali DR-S a norma DIN 6537L, 5 x Ø, angolo di punta 140°, codolo DIN 6535HA
- Forets hélicoïdaux DR-S selon DIN 6537L - 5 x Ø, angle de pointe 140°, queue selon DIN 6535HA
- 整体硬质合金 DR-S 系列 钻头-相等于DIN6537L-加工深度5xD,柄部标准DIN 6535L,顶角140°

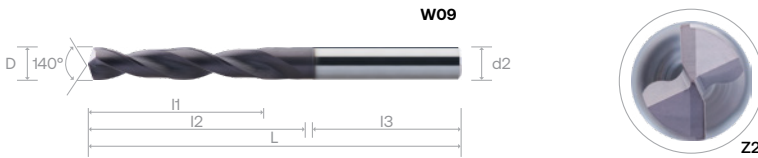
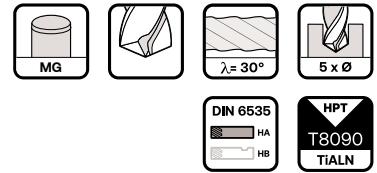

Order Number	Dimension (mm)						T8090	Order Number	Dimension (mm)						T8090	
	D (m7)	I1	I2	I3	L	d2 (h6)			D (m7)	I1	I2	I3	L	d2 (h6)		
W09 0300 *	3	23	28	36	66	6	•	W09 0820 *	8.2	49	61	40	103	10	•	
W09 0310 *	3.1		28	36	66	6	•	W09 0830 *	8.3		61	40	103	10	•	
W09 0320 *	3.2		28	36	66	6	•	W09 0840 *	8.4		61	40	103	10	•	
W09 0330 *	3.3		28	36	66	6	•	W09 0850 *	8.5		61	40	103	10	•	
W09 0340 *	3.4		28	36	66	6	•	W09 0860 *	8.6		61	40	103	10	•	
W09 0350 *	3.5		28	36	66	6	•	W09 0870 *	8.7		61	40	103	10	•	
W09 0360 *	3.6		28	36	66	6	•	W09 0880 *	8.8		61	40	103	10	•	
W09 0370 *	3.7		28	36	66	6	•	W09 0890 *	8.9		61	40	103	10	•	
W09 0380 *	3.8		36	36	74	6	•	W09 0900 *	9.0		61	40	103	10	•	
W09 0390 *	3.9		36	36	74	6	•	W09 0910 *	9.1		61	40	103	10	•	
W09 0400 *	4	29	36	36	74	6	•	W09 0920 *	9.2	61	40	103	10	•		
W09 0410 *	4.1		36	36	74	6	•	W09 0930 *	9.3	61	40	103	10	•		
W09 0420 *	4.2		36	36	74	6	•	W09 0940 *	9.4	61	40	103	10	•		
W09 0430 *	4.3		36	36	74	6	•	W09 0950 *	9.5	61	40	103	10	•		
W09 0440 *	4.4		36	36	74	6	•	W09 0960 *	9.6	61	40	103	10	•		
W09 0450 *	4.5		36	36	74	6	•	W09 0970 *	9.7	61	40	103	10	•		
W09 0460 *	4.6		36	36	74	6	•	W09 0980 *	9.8	61	40	103	10	•		
W09 0470 *	4.7		36	36	74	6	•	W09 0990 *	9.9	61	40	103	10	•		
W09 0480 *	4.8		35	44	36	82	6	•	W09 1000 *	10	56	61	40	103	10	•
W09 0490 *	4.9			44	36	82	6	•	W09 1020 *	10.2		71	45	118	12	•
W09 0500 *	5	44		36	82	6	•	W09 1050 *	10.5	71		45	118	12	•	
W09 0510 *	5.1	44		36	82	6	•	W09 1080 *	10.8	71		45	118	12	•	
W09 0520 *	5.2	44		36	82	6	•	W09 1100 *	11	71		45	118	12	•	
W09 0530 *	5.3	44		36	82	6	•	W09 1120 *	11.2	71		45	118	12	•	
W09 0540 *	5.4	44		36	82	6	•	W09 1130 *	11.3	71		45	118	12	•	
W09 0550 *	5.5	44		36	82	6	•	W09 1150 *	11.5	71		45	118	12	•	
W09 0560 *	5.6	44		36	82	6	•	W09 1180 *	11.8	71		45	118	12	•	
W09 0570 *	5.7	44		36	82	6	•	W09 1200 *	12.0	71		45	118	12	•	
W09 0580 *	5.8	43	44	36	82	6	•	W09 1220 *	12.2	60	77	45	124	14	•	
W09 0590 *	5.9		44	36	82	6	•	W09 1250 *	12.5		77	45	124	14	•	
W09 0600 *	6		44	36	82	6	•	W09 1270 *	12.7		77	45	124	14	•	
W09 0610 *	6.1		53	36	91	8	•	W09 1280 *	12.8		77	45	124	14	•	
W09 0620 *	6.2		53	36	91	8	•	W09 1300 *	13		77	45	124	14	•	
W09 0630 *	6.3		53	36	91	8	•	W09 1330 *	13.3		77	45	124	14	•	
W09 0640 *	6.4		53	36	91	8	•	W09 1350 *	13.5		77	45	124	14	•	
W09 0650 *	6.5		53	36	91	8	•	W09 1370 *	13.7		77	45	124	14	•	
W09 0660 *	6.6		53	36	91	8	•	W09 1380 *	13.8		77	45	124	14	•	
W09 0670 *	6.7		53	36	91	8	•	W09 1400 *	14.0		77	45	124	14	•	
W09 0680 *	6.8	49	53	36	91	8	•	W09 1450 *	14.5	63	83	48	133	16	•	
W09 0690 *	6.9		53	36	91	8	•	W09 1500 *	15.0		83	48	133	16	•	
W09 0700 *	7.0		53	36	91	8	•	W09 1530 *	15.3		83	48	133	16	•	
W09 0710 *	7.1		53	36	91	8	•	W09 1550 *	15.5		83	48	133	16	•	
W09 0720 *	7.2		53	36	91	8	•	W09 1580 *	15.8		83	48	133	16	•	
W09 0730 *	7.3		53	36	91	8	•	W09 1600 *	16		83	48	133	16	•	
W09 0740 *	7.4		53	36	91	8	•	W09 1650 *	16.5		93	48	143	18	•	
W09 0750 *	7.5		53	36	91	8	•	W09 1700 *	17		93	48	143	18	•	
W09 0760 *	7.6		53	36	91	8	•	W09 1750 *	17.5		93	48	143	18	•	
W09 0770 *	7.7		53	36	91	8	•	W09 1800 *	18		93	48	143	18	•	
W09 0780 *	7.8	49	53	36	91	8	•	W09 1850 *	18.5	71	101	50	153	20	•	
W09 0790 *	7.9		53	36	91	8	•	W09 1900 *	19		101	50	153	20	•	
W09 0800 *	8.0		53	36	91	8	•	W09 1950 *	19.5		101	50	153	20	•	
W09 0810 *	8.1		61	40	103	10	•	W09 2000 *	20		101	50	153	20	•	

* - DIN 6535

Material Group | Material-Gruppe | Groupe Matière | Gruppo Materiali | 材质主类







Cutting Parameter

475 - 476

NC SPOT
 DR ALU
 EZ LINE - DRILL
 DR NITCO
 DR VA
DR-S
 DR MINI
 DR-LX
 DR 45 SB
 DR 60

DR-S OIL FEED TWIST DRILLS - DIN 6537K - 3 X Ø

-  VHM DR-S Spiralbohrer nach DIN 6537K, 140° Spitzenwinkel, Schaft nach DIN 6535HA
-  Punta elicoidali DR-S a norma DIN 6537K, 3 x ø, con foro di lubrificazione, angolo di punta 140°, codolo DIN 6535HA
-  Forets hélicoïdaux DR-S selon DIN 6537K - 3 x Ø, angle de pointe 140°, queue selon DIN 6535HA
-  整体硬质合金 DR-S 系列 钻头-相等于DIN6537K-加工深度3xD,柄部标准DIN 6535K,顶角140°

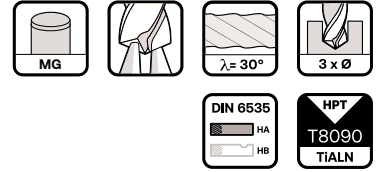

Order Number	Dimension (mm)						T8090	Order Number	Dimension (mm)						T8090
	D (m7)	I1	I2	I3	L	d2 (h6)			D (m7)	I1	I2	I3	L	d2 (h6)	
W10 0300 *	3	14	20	36	62	6	•	W10 0820 *	8.2	35	47	40	89	10	•
W10 0310 *	3.1		20	36	62	6	◦	W10 0830 *	8.3		47	40	89	10	•
W10 0320 *	3.2		20	36	62	6	•	W10 0840 *	8.4		47	40	89	10	•
W10 0330 *	3.3		20	36	62	6	•	W10 0850 *	8.5		47	40	89	10	•
W10 0340 *	3.4		20	36	62	6	•	W10 0860 *	8.6		47	40	89	10	•
W10 0350 *	3.5		20	36	62	6	•	W10 0870 *	8.7		47	40	89	10	•
W10 0360 *	3.6		20	36	62	6	•	W10 0880 *	8.8		47	40	89	10	•
W10 0370 *	3.7		20	36	62	6	•	W10 0890 *	8.9		47	40	89	10	•
W10 0380 *	3.8		24	36	66	6	•	W10 0900 *	9		47	40	89	10	•
W10 0390 *	3.9		24	36	66	6	•	W10 0910 *	9.1		47	40	89	10	•
W10 0400 *	4	24	36	66	6	•	W10 0920 *	9.2	47	40	89	10	•		
W10 0410 *	4.1	24	36	66	6	◦	W10 0930 *	9.3	47	40	89	10	•		
W10 0420 *	4.2	17	24	36	66	6	•	W10 0940 *	9.4	47	40	89	10	•	
W10 0430 *	4.3		24	36	66	6	•	W10 0950 *	9.5	47	40	89	10	•	
W10 0440 *	4.4		24	36	66	6	•	W10 0960 *	9.6	47	40	89	10	•	
W10 0450 *	4.5		24	36	66	6	•	W10 0970 *	9.7	47	40	89	10	•	
W10 0460 *	4.6		24	36	66	6	•	W10 0980 *	9.8	47	40	89	10	•	
W10 0470 *	4.7		24	36	66	6	•	W10 0990 *	9.9	47	40	89	10	•	
W10 0480 *	4.8		20	28	36	66	6	•	W10 1000 *	10	47	40	89	10	•
W10 0490 *	4.9			28	36	66	6	•	W10 1020 *	10.2	55	45	102	12	•
W10 0500 *	5			28	36	66	6	•	W10 1050 *	10.5	55	45	102	12	•
W10 0510 *	5.1			28	36	66	6	•	W10 1080 *	10.8	55	45	102	12	•
W10 0520 *	5.2	28		36	66	6	•	W10 1100 *	11	55	45	102	12	•	
W10 0530 *	5.3	28		36	66	6	•	W10 1120 *	11.2	55	45	102	12	•	
W10 0540 *	5.4	28		36	66	6	•	W10 1130 *	11.3	55	45	102	12	•	
W10 0550 *	5.5	28		36	66	6	•	W10 1150 *	11.5	55	45	102	12	•	
W10 0560 *	5.6	28		36	66	6	•	W10 1180 *	11.8	55	45	102	12	•	
W10 0570 *	5.7	28		36	66	6	•	W10 1200 *	12	55	45	102	12	•	
W10 0580 *	5.8	28	36	66	6	•	W10 1220 *	12.2	60	45	107	14	•		
W10 0590 *	5.9	28	36	66	6	•	W10 1250 *	12.5	60	45	107	14	•		
W10 0600 *	6	28	36	66	6	•	W10 1270 *	12.7	60	45	107	14	•		
W10 0610 *	6.1	24	34	36	79	8	•	W10 1280 *	12.8	60	45	107	14	•	
W10 0620 *	6.2		34	36	79	8	•	W10 1300 *	13	60	45	107	14	•	
W10 0630 *	6.3		34	36	79	8	•	W10 1330 *	13.3	60	45	107	14	•	
W10 0640 *	6.4		34	36	79	8	•	W10 1350 *	13.5	60	45	107	14	•	
W10 0650 *	6.5		34	36	79	8	•	W10 1370 *	13.7	60	45	107	14	◦	
W10 0660 *	6.6		34	36	79	8	•	W10 1400 *	14	60	45	107	14	•	
W10 0670 *	6.7		34	36	79	8	•	W10 1450 *	14.5	65	48	115	16	•	
W10 0680 *	6.8		34	36	79	8	•	W10 1500 *	15	65	48	115	16	•	
W10 0690 *	6.9		34	36	79	8	•	W10 1530 *	15.3	65	48	115	16	•	
W10 0700 *	7		34	36	79	8	•	W10 1550 *	15.5	65	48	115	16	•	
W10 0710 *	7.1	29	41	36	79	8	•	W10 1580 *	15.8	65	48	115	16	•	
W10 0720 *	7.2		41	36	79	8	•	W10 1600 *	16	65	48	115	16	•	
W10 0730 *	7.3		41	36	79	8	•	W10 1650 *	16.5	73	48	123	18	•	
W10 0740 *	7.4		41	36	79	8	•	W10 1700 *	17	73	48	123	18	•	
W10 0750 *	7.5		41	36	79	8	•	W10 1750 *	17.5	73	48	123	18	•	
W10 0760 *	7.6		41	36	79	8	•	W10 1800 *	18	73	48	123	18	•	
W10 0770 *	7.7		41	36	79	8	•	W10 1850 *	18.5	79	50	131	20	•	
W10 0780 *	7.8		41	36	79	8	•	W10 1900 *	19	79	50	131	20	•	
W10 0790 *	7.9		41	36	79	8	•	W10 1950 *	19.5	79	50	131	20	•	
W10 0800 *	8		41	36	79	8	•	W10 2000 *	20	79	50	131	20	•	
W10 0810 *	8.1	35	47	40	89	10	•								

* - DIN 6535

Material Group | Material-Gruppe | Groupe Matière | Gruppo Materiali | 材质主类

N01	N02	N03	K01	K02	P01	P02	P03	M01	M02	S01	S02	S03	H01	H02	O01	O02	Cutting Parameter
○	○	○	●	●	●	●	●	○	○	●	●	●	○	○	○	○	473 - 474

DR-S OIL FEED TWIST DRILLS - DIN 6537L - 5 X Ø

- VHM DR-S Kühkanalbohrer nach DIN 6537L, 140° Spitzenwinkel, Schaft nach DIN 6535HA
- Punta elicoidali DR-S a norma DIN 6537L, 5 x Ø, con foro di lubrificazione, angolo di punta 140°, codolo DIN 6535HA
- Forets hélicoïdaux DR-S à trous d'huile carbure selon DIN 6537L - 5 x Ø, angle de pointe 140°, queue selon DIN 6535HA
- 整体硬质合金 DR-S 系列 内冷孔钻头-相等于DIN6537L-加工深度5xD, 柄部标准DIN6535HA, 顶角140°

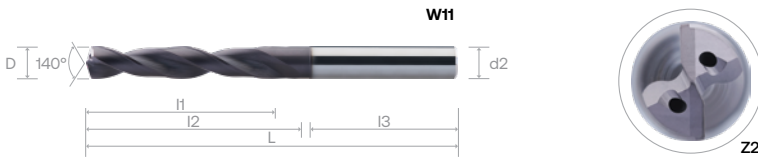
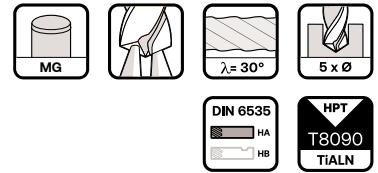

Order Number	Dimension (mm)						T8090	Order Number	Dimension (mm)						T8090
	D (m7)	I1	I2	I3	L	d2 (h6)			D (m7)	I1	I2	I3	L	d2 (h6)	
W11 0300 066 03	3	23	28	36	66	3	•	W11 0790	7.9	43	53	36	91	8	•
W11 0300 *	3		28	36	66	6	•	W11 0800	8		53	36	91	8	•
W11 0310 066 03	3.1		28	36	66	3	•	W11 0810 091 08 *	8.1		53	36	91	8	•
W11 0310 *	3.1		28	36	66	6	•	W11 0810	8.1		61	40	103	10	•
W11 0320 066 03	3.2		28	36	66	3	•	W11 0820	8.2		61	40	103	10	•
W11 0320 *	3.2		28	36	66	6	•	W11 0830	8.3		61	40	103	10	•
W11 0330 *	3.3		28	36	66	6	•	W11 0840 *	8.4		61	40	103	10	•
W11 0340 *	3.4		28	36	66	6	•	W11 0850 *	8.5		61	40	103	10	•
W11 0350 *	3.5		28	36	66	6	•	W11 0860 *	8.6		61	40	103	10	•
W11 0360 *	3.6		28	36	66	6	•	W11 0870 *	8.7		61	40	103	10	•
W11 0370 *	3.7	28	36	66	6	•	W11 0880 *	8.8	61	40	103	10	•		
W11 0380 *	3.8	29	36	36	74	6	•	W11 0890 *	8.9	61	40	103	10	•	
W11 0390 *	3.9		36	36	74	6	•	W11 0900 *	9	61	40	103	10	•	
W11 0400 074 04	4		36	36	74	4	•	W11 0910 *	9.1	61	40	103	10	•	
W11 0400 *	4		36	36	74	6	•	W11 0920 *	9.2	61	40	103	10	•	
W11 0410 074 04	4.1		36	36	74	4	•	W11 0930 *	9.3	61	40	103	10	•	
W11 0410 *	4.1		36	36	74	6	•	W11 0940 *	9.4	61	40	103	10	•	
W11 0420 074 04	4.2		36	36	74	4	•	W11 0950 *	9.5	61	40	103	10	•	
W11 0420 *	4.2		36	36	74	6	•	W11 0960 *	9.6	61	40	103	10	•	
W11 0430 *	4.3		36	36	74	6	•	W11 0970 *	9.7	61	40	103	10	•	
W11 0440 *	4.4		36	36	74	6	•	W11 0980 *	9.8	61	40	103	10	•	
W11 0450 *	4.5	36	36	74	6	•	W11 0990 *	9.9	61	40	103	10	•		
W11 0460 *	4.6	36	36	74	6	•	W11 1000 *	10	61	40	103	10	•		
W11 0470 *	4.7	36	36	74	6	•	W11 1020 *	10.2	56	71	45	118	12	•	
W11 0480 *	4.8	44	36	82	6	•	W11 1050 *	10.5		71	45	118	12	•	
W11 0490 *	4.9	44	36	82	6	•	W11 1080 *	10.8		71	45	118	12	•	
W11 0500 *	5	44	36	82	6	•	W11 1100 *	11		71	45	118	12	•	
W11 0510 *	5.1	44	36	82	6	•	W11 1120 *	11.2		71	45	118	12	•	
W11 0520 *	5.2	44	36	82	6	•	W11 1130 *	11.3		71	45	118	12	•	
W11 0530 *	5.3	44	36	82	6	•	W11 1150 *	11.5		71	45	118	12	•	
W11 0540 *	5.4	44	36	82	6	•	W11 1180 *	11.8		71	45	118	12	•	
W11 0550 *	5.5	44	36	82	6	•	W11 1200 *	12		71	45	118	12	•	
W11 0560 *	5.6	44	36	82	6	•	W11 1220 *	12.2		77	45	124	14	•	
W11 0570 *	5.7	44	36	82	6	•	W11 1250 *	12.5	77	45	124	14	•		
W11 0580 *	5.8	44	36	82	6	•	W11 1270 *	12.7	77	45	124	14	•		
W11 0590 *	5.9	44	36	82	6	•	W11 1280 *	12.8	77	45	124	14	•		
W11 0600 *	6	44	36	82	6	•	W11 1300 *	13	60	77	45	124	14	•	
W11 0610 082 06 *	6.1	44	36	82	6	•	W11 1330 *	13.3		77	45	124	14	•	
W11 0610 *	6.1	53	36	91	8	•	W11 1350 *	13.5		77	45	124	14	•	
W11 0620 *	6.2	53	36	91	8	•	W11 1370 *	13.7		77	45	124	14	•	
W11 0630 *	6.3	53	36	91	8	•	W11 1380 *	13.8		77	45	124	14	•	
W11 0640 *	6.4	53	36	91	8	•	W11 1400 *	14		77	45	124	14	•	
W11 0650 *	6.5	53	36	91	8	•	W11 1450 *	14.5		83	48	133	16	•	
W11 0660 *	6.6	53	36	91	8	•	W11 1500 *	15		83	48	133	16	•	
W11 0670 *	6.7	53	36	91	8	•	W11 1530 *	15.3		83	48	133	16	•	
W11 0680 *	6.8	53	36	91	8	•	W11 1550 *	15.5		83	48	133	16	•	
W11 0690 *	6.9	53	36	91	8	•	W11 1580 *	15.8	83	48	133	16	•		
W11 0700 *	7	43	53	36	91	8	•	W11 1600 *	16	83	48	133	16	•	
W11 0710 *	7.1		53	36	91	8	•	W11 1650 *	16.5	93	48	143	18	•	
W11 0720 *	7.2		53	36	91	8	•	W11 1700 *	17	93	48	143	18	•	
W11 0730 *	7.3		53	36	91	8	•	W11 1750 *	17.5	93	48	143	18	•	
W11 0740 *	7.4		53	36	91	8	•	W11 1800 *	18	93	48	143	18	•	
W11 0750 *	7.5		53	36	91	8	•	W11 1850 *	18.5	101	50	153	20	•	
W11 0760 *	7.6		53	36	91	8	•	W11 1900 *	19	101	50	153	20	•	
W11 0770 *	7.7		53	36	91	8	•	W11 1950 *	19.5	101	50	153	20	•	
W11 0780 *	7.8		53	36	91	8	•	W11 2000 *	20	101	50	153	20	•	

* - DIN 6535

Material Group | Material-Gruppe | Groupe Matière | Gruppo Materiali | 材质主类

N01	N02	N03	K01	K02	P01	P02	P03	M01	M02	S01	S02	S03	H01	H02	O01	O02
-----	-----	-----	-----	-----	-----	-----	-----	-----	-----	-----	-----	-----	-----	-----	-----	-----

Cutting Parameter

473 - 474

NC SPOT
DR ALU
EZ LINE - DRILL
DR NITCO
DR VA
DR-S
DR MINI
DR-LX
DR 45 SB
DR 60

Recommended Cutting Data



Note: These recommended cutting data indicators are just for reference. They should be adjusted according to the different cutting condition



DR-S Twist Drills, 3xD & 5xD Internal Coolant, 2 Flutes - W10, W11



Aggressive	N						K				S	
Working Material	Wrought Aluminium		Cast Aluminium		Copper Alloy		Grey Cast Iron		Ductile Cast Iron		Titanium alloy	
Properties	Si < 9%		Si ≥ 9%		-		-		-		-	
D	Vc	fn	Vc	fn	Vc	fn	Vc	fn	Vc	fn	Vc	fn
3		0.076		0.073		0.077		0.073		0.071		0.047
4		0.107		0.102		0.107		0.104		0.099		0.066
5		0.140		0.134		0.139		0.136		0.128		0.085
6		0.176		0.169		0.172		0.172		0.160		0.105
7		0.216		0.204		0.206		0.211		0.194		0.126
8		0.256		0.244		0.245		0.252		0.230		0.166
9		0.301		0.287		0.281		0.297		0.268		0.173
10		0.347		0.327		0.324		0.344		0.308		0.208
11		0.397		0.377		0.369		0.394		0.351		0.233
12	310	0.446	220	0.424	190	0.408	140	0.447	105	0.395	40	0.255
13		0.471		0.450		0.434		0.472		0.415		0.280
14		0.486		0.461		0.452		0.495		0.433		0.270
15		0.505		0.483		0.472		0.517		0.449		0.289
16		0.516		0.500		0.499		0.537		0.463		0.313
17		0.522		0.505		0.513		0.554		0.475		0.313
18		0.536		0.526		0.531		0.570		0.485		0.300
19		0.544		0.532		0.548		0.585		0.494		0.329
20		0.540		0.525		0.549		0.597		0.500		0.314

DR-S Twist Drills, 3xD & 5xD Internal Coolant, 2 Flutes - W10, W11



Aggressive	P						M				S	
Working Material	Carbon Steel		Alloy Steel		Prehardened Steel		Stainless Steel		Stainless Steel		Nickel Alloy	
Properties	-		520 < Rm < 1200		35 ≤ HRC < 45		High Machinability		Low Machinability		-	
D	Vc	fn	Vc	fn	Vc	fn	Vc	fn	Vc	fn	Vc	fn
3		0.063		0.068		0.080		0.048		0.054		0.026
4		0.090		0.098		0.110		0.067		0.075		0.039
5		0.119		0.132		0.143		0.085		0.094		0.048
6		0.151		0.171		0.178		0.106		0.115		0.058
7		0.185		0.214		0.215		0.125		0.135		0.075
8		0.222		0.261		0.253		0.150		0.160		0.086
9		0.262		0.312		0.294		0.168		0.178		0.092
10		0.304		0.368		0.337		0.190		0.206		0.108
11		0.349		0.427		0.382		0.217		0.220		0.118
12	175	0.396	120	0.491	65	0.429	60	0.250	50	0.236	35	0.130
13		0.417		0.503		0.457		0.267		0.254		0.133
14		0.437		0.511		0.484		0.279		0.275		0.150
15		0.454		0.515		0.509		0.292		0.291		0.150
16		0.470		0.514		0.534		0.317		0.320		0.157
17		0.484		0.509		0.557		0.308		0.320		0.157
18		0.496		0.499		0.578		0.336		0.344		0.157
19		0.506		0.485		0.599		0.327		0.344		0.183
20		0.514		0.466		0.618		0.350		0.375		0.183

NC SPOT
DR ALU
EZ LINE - DRILL
DR NITCO
DR VA
DR-S
DR MINI
DR-LX
DR 45 SB
DR 60

Recommended Cutting Data



Note: These recommended cutting data indicators are just for reference. They should be adjusted according to the different cutting condition



DR-S Twist Drills, 3xD & 5xD Internal Coolant, 2 Flutes - W10, W11

Conventional	N						K				S	
Working Material	Wrought Aluminium		Cast Aluminium		Copper Alloy		Grey Cast Iron		Ductile Cast Iron		Titanium alloy	
Properties	Si < 9%		Si ≥ 9%		-		-		-		-	
D	Vc	fn	Vc	fn	Vc	fn	Vc	fn	Vc	fn	Vc	fn
3		0.069		0.065		0.050		0.058		0.046		0.046
4		0.097		0.091		0.073		0.081		0.063		0.067
5		0.127		0.120		0.098		0.104		0.081		0.080
6		0.159		0.150		0.126		0.128		0.100		0.108
7		0.195		0.184		0.158		0.156		0.120		0.118
8		0.232		0.216		0.191		0.185		0.142		0.156
9		0.273		0.254		0.226		0.210		0.165		0.175
10		0.314		0.292		0.269		0.239		0.186		0.188
11		0.359		0.334		0.306		0.276		0.211		0.214
12	240	0.406	200	0.370	160	0.351	85	0.309	65	0.222	22	0.250
13		0.431		0.400		0.365		0.333		0.250		0.250
14		0.451		0.417		0.381		0.345		0.267		0.250
15		0.475		0.437		0.400		0.353		0.279		0.300
16		0.492		0.460		0.406		0.388		0.300		0.280
17		0.511		0.474		0.417		0.406		0.300		0.280
18		0.521		0.489		0.414		0.394		0.317		0.350
19		0.532		0.506		0.426		0.413		0.345		0.350
20		0.541		0.522		0.419		0.429		0.336		0.325

DR-S Twist Drills, 3xD & 5xD Internal Coolant, 2 Flutes - W10, W11



Conventional	P						M				S	
Working Material	Carbon Steel		Alloy Steel		Prehardened Steel		Stainless Steel		Stainless Steel		Nickel Alloy	
Properties	-		520 < Rm < 1200		35 ≤ HRC < 45		High Machinability		Low Machinability		-	
D	Vc	fn	Vc	fn	Vc	fn	Vc	fn	Vc	fn	Vc	fn
3		0.069		0.065		0.073		0.039		0.044		0.038
4		0.099		0.095		0.100		0.057		0.067		0.058
5		0.131		0.128		0.130		0.074		0.080		0.070
6		0.166		0.166		0.162		0.089		0.100		0.088
7		0.204		0.208		0.196		0.113		0.121		0.100
8		0.244		0.253		0.230		0.129		0.142		0.133
9		0.288		0.303		0.268		0.146		0.164		0.133
10		0.334		0.357		0.307		0.158		0.180		0.160
11		0.384		0.414		0.348		0.182		0.211		0.160
12	110	0.436	80	0.476	40	0.390	35	0.200	30	0.225	15	0.200
13		0.459		0.488		0.416		0.222		0.225		0.200
14		0.481		0.496		0.440		0.250		0.257		0.200
15		0.499		0.499		0.463		0.238		0.243		0.200
16		0.517		0.498		0.486		0.271		0.283		0.267
17		0.532		0.493		0.507		0.271		0.283		0.267
18		0.546		0.484		0.526		0.257		0.267		0.267
19		0.557		0.471		0.545		0.300		0.267		0.267
20		0.565		0.452		0.562		0.283		0.300		0.233

NC SPOT
DR ALU
EZ LINE - DRILL
DR NITCO
DR VA
DR-S
DR MINI
DR-LX
DR 45 SB
DR 60

Recommended Cutting Data



Note: These recommended cutting data indicators are just for reference. They should be adjusted according to the different cutting condition



DR-S Twist Drills, 3xD & 5xD External Coolant, 2 Flutes - W08, W09



Aggressive	N						K				S	
Working Material	Wrought Aluminium		Cast Aluminium		Copper Alloy		Grey Cast Iron		Ductile Cast Iron		Titanium alloy	
Properties	Si < 9%		Si ≥ 9%		-		-		-		-	
D	Vc	fn	Vc	fn	Vc	fn	Vc	fn	Vc	fn	Vc	fn
3		0.058		0.063		0.062		0.070		0.052		0.037
4		0.081		0.087		0.085		0.095		0.073		0.055
5		0.104		0.111		0.110		0.120		0.096		0.069
6		0.128		0.138		0.136		0.145		0.119		0.086
7		0.155		0.164		0.165		0.170		0.144		0.100
8		0.183		0.194		0.194		0.200		0.171		0.130
9		0.211		0.222		0.224		0.226		0.200		0.144
10		0.241		0.254		0.257		0.252		0.230		0.175
11		0.272		0.287		0.290		0.282		0.263		0.175
12	200	0.300	165	0.321	140	0.318	95	0.308	70	0.296	25	0.200
13		0.322		0.339		0.339		0.333		0.314		0.200
14		0.335		0.357		0.361		0.359		0.332		0.233
15		0.349		0.368		0.378		0.371		0.348		0.233
16		0.365		0.391		0.393		0.405		0.365		0.260
17		0.374		0.409		0.399		0.428		0.379		0.260
18		0.383		0.412		0.418		0.447		0.393		0.260
19		0.394		0.429		0.426		0.469		0.406		0.260
20		0.406		0.432		0.430		0.463		0.4178575		0.300

DR-S Twist Drills, 3xD & 5xD External Coolant, 2 Flutes - W08, W09



Aggressive	P						M				S	
Working Material	Carbon Steel		Alloy Steel		Prehardened Steel		Stainless Steel		Stainless Steel		Nickel Alloy	
Properties	-		520 < Rm < 1200		35 ≤ HRC < 45		High Machinability		Low Machinability		-	
D	Vc	fn	Vc	fn	Vc	fn	Vc	fn	Vc	fn	Vc	fn
3		0.072		0.061		0.060		0.049		0.042		0.036
4		0.100		0.085		0.083		0.069		0.061		0.056
5		0.128		0.111		0.107		0.088		0.074		0.069
6		0.157		0.138		0.132		0.109		0.095		0.082
7		0.188		0.166		0.157		0.132		0.113		0.090
8		0.221		0.197		0.184		0.156		0.136		0.125
9		0.250		0.230		0.212		0.173		0.146		0.125
10		0.285		0.264		0.241		0.208		0.167		0.143
11		0.319		0.300		0.272		0.233		0.182		0.167
12	105	0.361	80	0.338	50	0.303	40	0.255	35	0.200	20	0.167
13		0.385		0.357		0.323		0.280		0.222		0.200
14		0.413		0.375		0.342		0.270		0.250		0.200
15		0.422		0.391		0.360		0.300		0.238		0.200
16		0.457		0.406		0.377		0.325		0.271		0.250
17		0.475		0.419		0.394		0.313		0.271		0.250
18		0.489		0.431		0.409		0.313		0.257		0.250
19		0.511		0.442		0.423		0.343		0.300		0.250
20		0.529		0.452		0.437		0.329		0.283		0.225

NC SPOT
 DR ALU
 EZ LINE - DRILL
 DR NITCO
 DR VA
 DR-S
 DR MINI
 DR-LX
 DR 45 SB
 DR 60

Recommended Cutting Data



Note: These recommended cutting data indicators are just for reference. They should be adjusted according to the different cutting condition



DR-S Twist Drills, 3xD & 5xD External Coolant, 2 Flutes - W08, W09



Conventional	N						K				S	
Working Material	Wrought Aluminium		Cast Aluminium		Copper Alloy		Grey Cast Iron		Ductile Cast Iron		Titanium alloy	
Properties	Si < 9%		Si ≥ 9%		-		-		-		-	
D	Vc	fn	Vc	fn	Vc	fn	Vc	fn	Vc	fn	Vc	fn
3		0.055		0.062		0.060		0.061		0.039		0.032
4		0.077		0.085		0.082		0.083		0.055		0.050
5		0.100		0.109		0.106		0.104		0.072		0.062
6		0.124		0.135		0.131		0.126		0.089		0.073
7		0.149		0.161		0.158		0.149		0.108		0.090
8		0.177		0.190		0.187		0.174		0.128		0.113
9		0.204		0.218		0.215		0.197		0.150		0.113
10		0.235		0.249		0.246		0.219		0.172		0.143
11		0.266		0.281		0.278		0.246		0.196		0.167
12	150	0.300	130	0.314	100	0.306	75	0.268	70	0.221	20	0.167
13		0.319		0.332		0.326		0.290		0.235		0.200
14		0.329		0.350		0.347		0.313		0.248		0.200
15		0.350		0.360		0.363		0.324		0.261		0.200
16		0.363		0.383		0.377		0.353		0.273		0.250
17		0.369		0.401		0.383		0.373		0.284		0.250
18		0.385		0.403		0.401		0.389		0.294		0.250
19		0.388		0.421		0.409		0.408		0.304		0.250
20		0.408		0.423		0.413		0.403		0.313		0.225

DR-S Twist Drills, 3xD & 5xD External Coolant, 2 Flutes - W08, W09



Conventional	P						M				S	
Working Material	Carbon Steel		Alloy Steel		Prehardened Steel		Stainless Steel		Stainless Steel		Nickel Alloy	
Properties	-		520 < Rm < 1200		35 ≤ HRC < 45		High Machinability		Low Machinability		-	
D	Vc	fn	Vc	fn	Vc	fn	Vc	fn	Vc	fn	Vc	fn
3		0.060		0.055		0.040		0.044		0.041		0.023
4		0.084		0.076		0.055		0.063		0.060		0.040
5		0.110		0.099		0.071		0.075		0.075		0.050
6		0.135		0.124		0.088		0.100		0.093		0.057
7		0.162		0.149		0.105		0.114		0.108		0.083
8		0.194		0.177		0.123		0.142		0.140		0.100
9		0.221		0.206		0.142		0.155		0.156		0.100
10		0.254		0.237		0.161		0.180		0.188		0.150
11		0.283		0.269		0.182		0.200		0.188		0.150
12	80	0.318	60	0.303	40	0.203	30	0.225	25	0.214	12	0.150
13		0.345		0.320		0.216		0.225		0.214		0.200
14		0.358		0.336		0.229		0.257		0.250		0.200
15		0.394		0.351		0.240		0.243		0.233		0.200
16		0.406		0.364		0.252		0.283		0.280		0.167
17		0.427		0.376		0.263		0.283		0.280		0.167
18		0.420		0.387		0.274		0.267		0.260		0.167
19		0.443		0.397		0.283		0.267		0.260		0.167
20		0.462		0.406		0.292		0.300		0.300		0.200

NC SPOT
DR ALU
EZ LINE - DRILL
DR NITCO
DR VA
DR-S
DR MINI
DR-LX
DR 45 SB
DR 60

FEATURES & BENEFITS

DR Mini

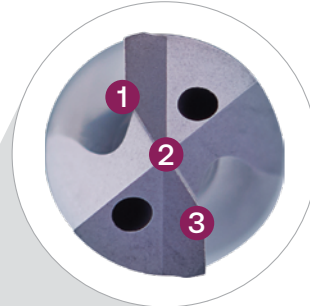

1 Split Point Design

Provides self centering ability and reduced thrust

2 X-Thinning

Better self-centering on initial cutting

3 Straight Edge Profile

Shorter chip and reinforced cutting edge

4 Polished Flute

- Smoother chips evacuation
- Less build up edge

5 Suitable for Material





1. Kreuzanschliff
Bietet Selbstzentrierung und reduzierten Axialdruck
2. X-Ausspitzung
Bessere Selbstzentrierung beim Anschnitt
3. Gerades Kantenprofil
Kürzerer Span und verstärkte Schneidkante
4. Polierte Schneiden
Verbesserter problemloser Spänefluß
Weniger Aufbauschneiden
5. Geeignet für die Materialgruppen P, K, N, M, S



1. 分割点设计
提供自定心能力和减小推力。
2. X变薄
初始切割时更好的自定心能力。
3. 直边轮廓
较短的碎屑和强化的切削刃。
4. 抛光槽
更顺畅的排屑。
更少的堆积边缘。
5. 适用于材料 P、K、N、M、S



1. 1. Struttura del punto di ripartizione
Offre capacità autocentranti e spinta ridotta
2. X-assottigliamento
Miglior autocentraggio al taglio iniziale
3. Profilo dritto
Trucioli più corti e angolo di taglio rinforzato
4. Scanalature altamente levigate
Evacuazione dei trucioli più semplice
Meno formazione di materiale di riporto
5. Adatto per il materiale P, K, N, M, S



1. Conception à affûtage croisé
Permet une capacité de centrage automatique et une poussée réduite
2. Amincissement en X
Meilleur auto-centrage à l'attaque du perçage
3. Profil d'arête droite
Copeaux plus courts et arête de coupe renforcée
4. Goujures hautement polies
Évacuation des copeaux plus fluide
Moins d'accumulation sur les arêtes
5. Adapté aux matériaux P, K, N, M, S

DR MINI OIL FEED MINIATURE TWIST DRILLS - 135° POINT ANGLE - 5 X Ø, 8X Ø, 12 X Ø, 15X Ø, 20X Ø, 25X Ø, 30X Ø

- VHM DR MINI Kühlkanalbohrer nach 135° Spitzenwinkel, Schaft nach DIN 6535HA 5 x Ø, 8x Ø, 12 x Ø, 15x Ø, 20x Ø, 25x Ø, 30x Ø
- Punta elicoidali DR MINI, con foro di lubrificazione, angolo di punta 135°, codolo DIN 6535HA- 5 x Ø, 8x Ø, 12 x Ø, 15x Ø, 20x Ø, 25x Ø, 30x Ø
- Forets hélicoïdaux DR MINI à trous d'huile angle de pointe 135°, queue selon DIN 6535HA- 5 x Ø, 8x Ø, 12 x Ø, 15x Ø, 20x Ø, 25x Ø, 30x Ø
- 整体硬质合金 DR MINI 系列 内冷孔钻头-相等于2刃, 柄部标准DIN6535HA, 顶角135° 5 x Ø, 8x Ø, 12 x Ø, 15x Ø, 20x Ø, 25x Ø, 30x Ø

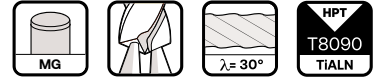

Order Number	Dimension (mm)						T8090	Order Number	Dimension (mm)						T8090
	Hole Depth I2/D	D (h7)	I1	I2	L	d2 (h6)			Hole Depth I2/D	D (h7)	I1	I2	L	d2 (h6)	
H03 0100 5	5 x D	1.00	6.5	8.0	50	3	•	H03 0180 5	5 x D	1.80	11.7	13.2	55	3	•
H03 0100 8	8 x D		9.5	11.0	50	3	•	H03 0180 8	8 x D		17.1	18.6	60	3	•
H03 0100 12	12 x D		13.5	15.0	55	3	•	H03 0180 12	12 x D		24.3	25.8	65	3	•
H03 0100 20	20 x D		21.5	23.0	65	3	•	H03 0180 20	20 x D		38.7	40.2	75	3	•
H03 0100 25	25 x D		26.5	28.0	70	3	•	H03 0180 25	25 x D		47.7	49.2	90	3	•
H03 0100 30	30 x D	31.5	33.0	75	3	•	H03 0180 30	30 x D	56.7	58.2	100	3	•		
H03 0100 5	5 x D	1.10	7.2	8.7	50	3	•	H03 0190 5	5 x D	1.90	12.4	13.9	55	3	•
H03 0100 8	8 x D		10.5	12.0	50	3	•	H03 0190 8	8 x D		18.1	19.6	60	3	•
H03 0100 12	12 x D		14.9	16.4	55	3	•	H03 0190 12	12 x D		25.7	27.2	65	3	•
H03 0100 20	20 x D		23.7	25.2	65	3	•	H03 0190 20	20 x D		40.9	42.4	75	3	•
H03 0100 25	25 x D		29.2	30.7	70	3	•	H03 0190 25	25 x D		50.4	51.9	90	3	•
H03 0100 30	30 x D	34.7	36.2	75	3	•	H03 0190 30	30 x D	59.9	61.4	100	3	•		
H03 0120 5	5 x D	1.20	7.8	9.3	50	3	•	H03 0200 5	5 x D	2.00	13.0	16.0	55	3	•
H03 0120 8	8 x D		11.4	12.9	50	3	•	H03 0200 8	8 x D		19.0	22.0	60	3	•
H03 0120 12	12 x D		16.2	17.7	55	3	•	H03 0200 12	12 x D		27.0	30.0	65	3	•
H03 0120 20	20 x D		25.8	27.3	65	3	•	H03 0200 20	20 x D		43.0	46.0	82	3	•
H03 0120 25	25 x D		31.8	33.3	75	3	•	H03 0200 25	25 x D		53.0	56.0	90	3	•
H03 0120 30	30 x D	37.8	39.3	75	3	•	H03 0200 30	30 x D	63.0	66.0	100	3	•		
H03 0130 5	5 x D	1.30	8.5	10.0	50	3	•	H03 0210 5	5 x D	2.10	13.7	16.9	55	3	•
H03 0130 8	8 x D		12.4	13.9	50	3	•	H03 0210 8	8 x D		20.0	23.2	60	3	•
H03 0130 12	12 x D		17.6	19.1	55	3	•	H03 0210 12	12 x D		28.4	31.6	65	3	•
H03 0130 20	20 x D		28.0	29.5	65	3	•	H03 0210 20	20 x D		45.2	48.4	82	3	•
H03 0130 25	25 x D		34.5	36.0	75	3	•	H03 0210 25	25 x D		55.7	58.8	100	3	•
H03 0130 30	30 x D	41.0	42.5	85	3	•	H03 0210 30	30 x D	66.2	69.3	110	3	•		
H03 0140 5	5 x D	1.40	9.1	10.6	50	3	•	H03 0220 5	5 x D	2.20	14.3	17.6	55	3	•
H03 0140 8	8 x D		13.3	14.8	50	3	•	H03 0220 8	8 x D		20.9	24.2	60	3	•
H03 0140 12	12 x D		18.9	20.4	55	3	•	H03 0220 12	12 x D		29.7	33.0	65	3	•
H03 0140 20	20 x D		30.1	31.6	65	3	•	H03 0220 20	20 x D		47.3	50.6	82	3	•
H03 0140 25	25 x D		37.1	38.6	75	3	•	H03 0220 25	25 x D		58.3	61.6	100	3	•
H03 0140 30	30 x D	44.1	45.6	85	3	•	H03 0220 30	30 x D	69.3	72.6	110	3	•		
H03 0150 5	5 x D	1.50	9.8	11.3	50	3	•	H03 0230 5	5 x D	2.30	15.0	18.5	55	3	•
H03 0150 8	8 x D		14.3	15.8	50	3	•	H03 0230 8	8 x D		21.9	25.4	60	3	•
H03 0150 12	12 x D		20.3	21.8	55	3	•	H03 0230 12	12 x D		31.1	34.6	65	3	•
H03 0150 20	20 x D		32.3	33.8	75	3	•	H03 0230 20	20 x D		49.5	53.0	100	3	•
H03 0150 25	25 x D		39.8	41.3	80	3	•	H03 0230 25	25 x D		61.0	64.4	100	3	•
H03 0150 30	30 x D	47.3	48.8	85	3	•	H03 0230 30	30 x D	72.5	75.9	110	3	•		
H03 0160 5	5 x D	1.60	10.4	11.9	50	3	•	H03 0240 5	5 x D	2.40	15.6	19.2	55	3	•
H03 0160 8	8 x D		15.2	16.7	50	3	•	H03 0240 8	8 x D		22.8	26.4	60	3	•
H03 0160 12	12 x D		21.6	23.1	65	3	•	H03 0240 12	12 x D		32.4	36.0	75	3	•
H03 0160 20	20 x D		34.4	35.9	75	3	•	H03 0240 20	20 x D		51.6	55.2	100	3	•
H03 0160 25	25 x D		42.4	43.9	80	3	•	H03 0240 25	25 x D		63.6	67.2	100	3	•
H03 0160 30	30 x D	50.4	51.9	90	3	•	H03 0240 30	30 x D	75.6	79.2	120	3	•		
H03 0170 5	5 x D	1.70	11.1	12.6	55	3	•	H03 0250 5	5 x D	2.50	16.3	20.1	55	3	•
H03 0170 8	8 x D		16.2	17.7	60	3	•	H03 0250 8	8 x D		23.8	27.6	60	3	•
H03 0170 12	12 x D		23.0	24.5	65	3	•	H03 0250 12	12 x D		33.8	37.6	75	3	•
H03 0170 20	20 x D		36.6	38.1	75	3	•	H03 0250 20	20 x D		53.8	57.6	100	3	•
H03 0170 25	25 x D		45.1	46.6	80	3	•	H03 0250 25	25 x D		66.3	70.0	110	3	•
H03 0170 30	30 x D	53.6	55.1	90	3	•	H03 0250 30	30 x D	78.8	82.5	120	3	•		





* - DIN 6535

cont'd ▶

Material Group | Material-Gruppe | Groupe Matière | Gruppo Materiali | 材质主类

N01	N02	N03	K01	K02	P01	P02	P03	M01	M02	S01	S02	S03	H01	H02	O01	O02	Cutting Parameter 481 - 482
-----	-----	-----	-----	-----	-----	-----	-----	-----	-----	-----	-----	-----	-----	-----	-----	-----	--------------------------------

DR MINI OIL FEED MINIATURE TWIST DRILLS - 135° POINT ANGLE - 5 X Ø, 8X Ø, 12 X Ø, 15X Ø, 20X Ø, 25X Ø, 30X Ø

-  VHM DR MINI Kühlkanalbohrer nach 135° Spitzenwinkel, Schaft nach DIN 6535HA 5 x Ø, 8x Ø, Ø12 x Ø, 15x Ø, 20x Ø, 25x Ø, 30x Ø
-  Punta elicoidali DR MINI, con foro di lubrificazione, angolo di punta 135°, codolo DIN 6535HA- 5 x Ø, 8x Ø, 12 x Ø, 15x Ø, 20x Ø, 25x Ø, 30x Ø
-  Forets hélicoïdaux DR MINI à trous d'huile angle de pointe 135°, queue selon DIN 6535HA- 5 x Ø, 8x Ø, 12 x Ø, 15x Ø, 20x Ø, 25x Ø, 30x Ø
-  整体硬质合金 DR MINI 系列 内冷孔钻头-相等于2刃, 柄部标准DIN6535HA, 顶角135° 5 x Ø, 8x Ø, 12 x Ø, 15x Ø, 20x Ø, 25x Ø, 30x Ø

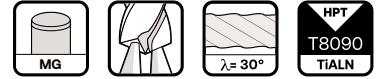

Order Number	Dimension (mm)						T8090	Order Number	Dimension (mm)						T8090	
	Hole Depth I2/D	D (h7)	I1	I2	L	d2 (h6)			Hole Depth I2/D	D (h7)	I1	I2	L	d2 (h6)		
H03 0260 5	5 x D	2.60	16.9	20.8	55	3	•									
H03 0260 8	8 x D		24.7	28.6	60	3	•									
H03 0260 12	12 x D		35.1	39.0	75	3	•									
H03 0260 20	20 x D		55.9	59.8	100	3	◦									
H03 0260 25	25 x D		68.9	72.8	110	3	•									
H03 0260 30	30 x D		81.9	85.8	120	3	•									
H03 0270 5	5 x D	2.70	17.6	21.7	55	3	•									
H03 0270 8	8 x D		25.7	29.8	60	3	•									
H03 0270 12	12 x D		36.5	40.6	75	3	•									
H03 0270 20	20 x D		58.1	62.2	100	3	•									
H03 0270 25	25 x D		71.6	75.6	110	3	•									
H03 0270 30	30 x D		85.1	89.1	130	3	•									
H03 0280 5	5 x D	2.80	18.2	22.4	55	3	•									
H03 0280 8	8 x D		26.6	30.8	60	3	•									
H03 0280 12	12 x D		37.8	42.0	75	3	•									
H03 0280 20	20 x D		60.2	64.4	100	3	•									
H03 0280 25	25 x D		74.2	78.4	110	3	•									
H03 0280 30	30 x D		88.2	92.4	130	3	•									
H03 0290 5	5 x D	2.90	18.9	23.3	55	3	•									
H03 0290 8	8 x D		27.6	32.0	60	3	•									
H03 0290 12	12 x D		39.2	43.6	75	3	•									
H03 0290 20	20 x D		61.4	65.8	100	3	•									
H03 0290 25	25 x D		76.9	81.2	120	3	•									
H03 0290 30	30 x D		91.4	95.7	130	3	•									
H03 0300 5	5 x D	3.00	19.5	24.0	55	3	•									
H03 0300 8	8 x D		28.5	33.0	60	3	•									
H03 0300 12	12 x D		40.5	45.0	75	3	•									
H03 0300 20	20 x D		64.5	69.0	100	3	•									
H03 0300 25	25 x D		79.5	84.0	120	3	•									
H03 0300 30	30 x D		94.5	99.0	130	3	•									

NC SPOT
DR ALU
EZ LINE - DRILL
DR NITCO
DR VA
DR-S
DR MINI
DR-LX
DR 45 SB
DR 60

Material Group | Material-Gruppe | Groupe Matière | Gruppo Materiali | 材质主类



Cutting Parameter

481 - 482

Recommended Cutting Data



Note: These recommended cutting data indicators are just for reference. They should be adjusted according to the different cutting condition



DR Mini Oil Feed Twist Drill - Point Angle 135°, 5 × D, 8 × D - H03



Working Material	N						K				S					
	Wrought Aluminium		Cast Aluminium		Copper Alloy		Grey Cast Iron		Ductile Cast Iron		Titanium alloy					
Properties	Si < 9%		Si ≥ 9%		-		-		-		-					
D	Vc	fn	Vc	fn	Vc	fn	Vc	fn	Vc	fn	Vc	fn				
1.0	145	0.017	125	0.018	115	0.016	85	0.018	65	0.016	30	0.013				
1.5		0.026		0.026									0.024	0.027	0.024	0.019
2.0		0.035		0.035									0.032	0.035	0.032	0.025
2.5		0.043		0.044									0.040	0.044	0.040	0.031
3.0		0.052		0.053									0.049	0.053	0.048	0.038

DR Mini Oil Feed Twist Drill - Point Angle 135°, 5 × D, 8 × D - H03



Working Material	P						M				S					
	Carbon Steel		Alloy Steel		Prehardened Steel		Stainless Steel		Stainless Steel		Nickel Alloy					
Properties	-		520 < Rm < 1200		35 ≤ HRC < 45		High Machinability		Low Machinability		-					
D	Vc	fn	Vc	fn	Vc	fn	Vc	fn	Vc	fn	Vc	fn				
1.0	90	0.017	80	0.016	65	0.014	60	0.015	40	0.014	20	0.009				
1.5		0.026		0.024									0.022	0.022	0.021	0.016
2.0		0.035		0.031									0.029	0.029	0.028	0.025
2.5		0.043		0.039									0.036	0.036	0.035	0.035
3.0		0.052		0.047									0.043	0.044	0.042	0.045

DR Mini Oil Feed Twist Drill - Point Angle 135°, 12 × D, 20 × D - H03



Working Material	N						K				S					
	Wrought Aluminium		Cast Aluminium		Copper Alloy		Grey Cast Iron		Ductile Cast Iron		Titanium alloy					
Properties	Si < 9%		Si ≥ 9%		-		-		-		-					
D	Vc	fn	Vc	fn	Vc	fn	Vc	fn	Vc	fn	Vc	fn				
1.0	130	0.016	115	0.016	105	0.015	80	0.014	55	0.014	30	0.010				
1.5		0.025		0.024									0.022	0.021	0.021	0.016
2.0		0.033		0.032									0.029	0.028	0.028	0.021
2.5		0.041		0.039									0.037	0.035	0.035	0.026
3.0		0.049		0.047									0.044	0.042	0.042	0.031

DR Mini Oil Feed Twist Drill - Point Angle 135°, 12 × D, 20 × D - H03



Working Material	P						M				S					
	Carbon Steel		Alloy Steel		Prehardened Steel		Stainless Steel		Stainless Steel		Nickel Alloy					
Properties	-		520 < Rm < 1200		35 ≤ HRC < 45		High Machinability		Low Machinability		-					
D	Vc	fn	Vc	fn	Vc	fn	Vc	fn	Vc	fn	Vc	fn				
1.0	85	0.014	65	0.014	55	0.010	50	0.010	40	0.009	15	0.010				
1.5		0.021		0.020									0.015	0.015	0.014	0.016
2.0		0.028		0.027									0.020	0.020	0.019	0.025
2.5		0.035		0.034									0.025	0.025	0.024	0.035
3.0		0.042		0.041									0.031	0.030	0.028	0.044

NC SPOT
DR ALU
EZ LINE - DRILL
DR NITCO
DR VA
DR-S
DR MINI
DR-LX
DR 45 SB
DR 60

Recommended Cutting Data



Note: These recommended cutting data indicators are just for reference. They should be adjusted according to the different cutting condition



DR Mini Oil Feed Twist Drill - Point Angle 135°, 25 × D, 30 × D - H03



Working Material	N						K				S					
	Wrought Aluminium		Cast Aluminium		Copper Alloy		Grey Cast Iron		Ductile Cast Iron		Titanium alloy					
Properties	Si < 9%		Si ≥ 9%		-		-		-		-					
D	Vc	fn	Vc	fn	Vc	fn	Vc	fn	Vc	fn	Vc	fn				
1.0	125	0.014	105	0.014	95	0.012	75	0.010	50	0.013	30	0.006				
1.5		0.021		0.021									0.018	0.015	0.019	0.009
2.0		0.028		0.027									0.024	0.020	0.025	0.013
2.5		0.035		0.034									0.030	0.025	0.031	0.015
3.0		0.042		0.041									0.036	0.030	0.037	0.019

DR Mini Oil Feed Twist Drill - Point Angle 135°, 25 × D, 30 × D - H03



Working Material	P						M				S					
	Carbon Steel		Alloy Steel		Prehardened Steel		Stainless Steel		Stainless Steel		Nickel Alloy					
Properties	-		520 < Rm < 1200		35 ≤ HRC < 45		High Machinability		Low Machinability		-					
D	Vc	fn	Vc	fn	Vc	fn	Vc	fn	Vc	fn	Vc	fn				
1.0	80	0.010	60	0.011	50	0.008	45	0.007	35	0.007	15	0.008				
1.5		0.015		0.016									0.011	0.010	0.011	0.013
2.0		0.020		0.022									0.015	0.014	0.014	0.021
2.5		0.025		0.027									0.019	0.017	0.018	0.030
3.0		0.031		0.033									0.022	0.021	0.021	0.038

NC SPOT
DR ALU
EZ LINE - DRILL
DR NITCO
DR VA
DR-S
DR MINI
DR-LX
DR 45 SB
DR 60

FEATURES & BENEFITS

DR-LX



3 Flexible Drilling

Able to drill reliably in continuous and peck drilling

1 Polished Flutes

Smoother chips evacuation and less built-up edge

2 Versatile Machining Condition

Able to drill reliably with various coolant pressure and cutting data

4 T8090 Tip Coating

Low friction, high wear resistance

5 State-of-the-Art Geometry

- For prolonged durability and excellent quality

Wider Flute Shape
- Better chip evacuation

Tougher Core Diameter
- Ensure chip can evacuate smooth yet rigid

GG Point Geometry
- Protect & Reduce Chipping

6 Suitable for Material





1. Polierte Schneide
Verbesserter problemloser Spänefluß
Weniger Aufbauschnneiden
2. Vielseitige Bearbeitungsbedingungen
Kann mit verschiedenen Kühlmitteldruck- und Schnittdaten zuverlässig bohren
3. Flexibles Bohren
Zuverlässiges Bohren im Dauer- und Hackbohren
4. T8090 Beschichtung
Mehrlagen AlTiN-Beschichtung verbessert die Lebensdauer des Werkzeugs
5. Modernste Geometrie
Für längere Haltbarkeit und hervorragende Qualität

Breitere Flötenform
Bessere Spanabfuhr

Zäherer Kerndurchmesser
Stellen Sie sicher, dass der Chip glatt und dennoch starr evakuiert werden kann

GG-Punktgeometrie
Absplittern schützen und reduzieren
6. Geeignet für die Materialien P, K, N, M, S



1. 拋光槽
更順暢的排屑。
減少堆積邊緣。
2. 多種加工條件
能夠可靠地進行各種鑽孔冷卻液壓力和切削數據。
3. 卓越的刀具塗層
多層 AlTiN 塗層可提高刀具壽命。
4. T8090 尖端塗層
多層 AlTiN 塗層可提高刀具壽命。
5. 最先進的幾何
延長耐用性和卓越品質。

長笛形狀
更好的排屑。

硬芯直徑
確保切屑能夠排出光滑而剛性的。

GG點幾何
保護和減少碎裂。
6. 适用于材料 P、K、N、M、S



1. Scanalatura levigata
Evacuazione dei trucioli più semplice
Meno formazione di materiale di riporto
2. Condizioni di lavorazione versatili
In grado di perforare in modo affidabile con vari dati di pressione del refrigerante e di taglio
3. Foratura flessibile Flexible
In grado di perforare in modo affidabile nella perforazione continua e beccata
4. T8090 Rivestimento della punta
Il rivestimento AlTiN multistrato migliora la durata dello strumento
5. Geometria all'avanguardia
Per una durata prolungata e una qualità eccellente

Forma di flauto più ampia
Migliore evacuazione del truciolo

Diametro del nucleo più duro
Assicurarsi che il truciolo possa evacuare liscio ma rigido

Geometria del punto GG
Proteggere e ridurre le scheggiature
6. Adatto per il materiale P, K, N, M, S



1. Goujure polie
Évacuation des copeaux plus fluide
Moins d'accumulation sur les arêtes
2. Condition d'usinage polyvalente
Capable de percer de manière fiable avec diverses pressions d'arrosage et données de coupe
3. Forage flexible
Capable de percer de manière fiable en forage continu et en perçage
4. T8090 Rivestimento della punta
Revêtement AlTiN multicouche pour une meilleure durée de vie de l'outil
5. Géométrie de pointe
Pour une durabilité prolongée et une excellente qualité

Forme de flûte plus large
Meilleure évacuation des copeaux

Diamètre de noyau plus dur
Assurez-vous que la puce peut évacuer en douceur mais rigide

Géométrie du point GG
Protéger et réduire l'écaillage
6. Adapté aux matériaux P, K, N, M, S



DR-LX SB OIL FEED TWIST DRILLS - 135° POINT ANGLE -12 X Ø, 15X Ø, 20X Ø, 25X Ø, 30X Ø

VHM DR-LX SB Kühlkanalbohrer nach 135° Spitzenwinkel, Schaft nach DIN 6535HA 12 x Ø, 15x Ø, 20x Ø, 25x Ø, 30x Ø

Punta elicoidali DR-LX SB, con foro di lubrificazione, angolo di punta 135°, codolo DIN 6535HA- 12 x Ø, 15x Ø, 20x Ø, 25x Ø, 30x Ø

Forets hélicoïdaux DR-LX SB à trous d'huile angle de pointe 135°, queue selon DIN 6535HA - 12 x Ø, 15x Ø, 20x Ø, 25x Ø, 30x Ø

整体硬质合金 DR-LX SB 系列内冷孔钻头-相等于2刃, 柄部标准DIN6535HA, 顶角135° 12 x Ø, 15x Ø, 20x Ø, 25x Ø, 30x Ø

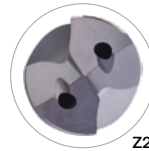

Order Number DIN 6535	Dimension (mm)									T8090	Order Number DIN 6535	Dimension (mm)									T8090
	Hole Depth I2/D	D (h7)	I1	I2 (Max. Drilling Depth)	I3	I4	L	d2 (h6)				Hole Depth I2/D	D (h7)	I1	I2 (Max. Drilling Depth)	I3	I4	L	d2 (h6)		
W05 0310 12	12 x D			45	50	32	85	4	•		W05 0520 12 *	5.20	26.0		72	81	36	120	6	•	
W05 0310 15	15 x D			50	55	32	90	4	•		W05 0530 12 *	5.30	26.5		72	81	36	120	6	•	
W05 0310 20	20 x D	3.10	15.5	64	69	32	105	4	•		W05 0540 12 *	5.40	27.0		72	81	36	120	6	•	
W05 0310 25	25 x D			79	83	32	120	4	•		W05 0550 12 *				72	81	36	120	6	•	
W05 0310 30	30 x D			94	99	32	135	4	•		W05 0550 15 *				85	93	36	130	6	•	
W05 0320 12		3.20	16.0	45	50	32	85	4	•		W05 0550 20 *	5.50	27.5		112	120	36	160	6	•	
W05 0330 12	12 x D	3.30	16.5	45	50	32	85	4	•		W05 0550 25 *				139	147	36	185	6	•	
W05 0340 12		3.40	17.0	48	54	32	90	4	•		W05 0550 30 *				166	174	36	215	6	•	
W05 0350 12	12 x D			48	54	32	90	4	•		W05 0560 12 *	5.60	28.0		72	81	36	120	6	•	
W05 0350 15	15 x D			55	60	32	95	4	•		W05 0570 12 *	5.70	28.5		72	81	36	120	6	•	
W05 0350 20	20 x D	3.50	17.5	72	77	32	110	4	•		W05 0580 12 *	5.80	29.0		72	81	36	120	6	•	
W05 0350 25	25 x D			89	94	32	130	4	•		W05 0590 12 *	5.90	29.5		72	81	36	120	6	•	
W05 0350 30	30 x D			106	111	32	145	4	•		W05 0600 12 *				72	81	36	120	6	•	
W05 0360 12	12 x D	3.60	18.0	48	54	32	90	4	•		W05 0600 15 *				92	101	36	140	6	•	
W05 0370 12		3.70	18.5	48	54	32	90	4	•		W05 0600 20 *	6.00	30.0		122	131	36	170	6	•	
W05 0380 12	12 x D			57	64	32	100	4	•		W05 0600 25 *				151	160	36	200	6	•	
W05 0380 25	25 x D	3.80	19.0	96	102	32	135	4	•		W05 0600 30 *				181	190	36	230	6	•	
W05 0380 30	30 x D			115	121	32	155	4	•		W05 0610 12 *	6.10	30.5		88	97	36	135	8	•	
W05 0390 12	12 x D	3.90	19.5	57	64	32	100	4	•		W05 0620 12 *	6.20	31.0		88	97	36	135	8	•	
W05 0400 12	12 x D			57	64	32	100	4	•		W05 0630 12 *	6.30	31.5		88	97	36	135	8	•	
W05 0400 15	15 x D			62	68	32	105	4	•		W05 0640 12 *	6.40	32.0		96	108	36	145	8	•	
W05 0400 20	20 x D	4.00	20.0	82	88	32	125	4	•		W05 0650 12 *				96	108	36	145	8	•	
W05 0400 25	25 x D			101	107	32	140	4	•		W05 0650 15 *	6.50	32.5		100	110	36	150	8	•	
W05 0400 30	30 x D			121	127	32	160	4	•		W05 0650 20 *				132	142	36	180	8	•	
W05 0410 12	12 x D	4.10	20.5	57	64	34	100	5	•		W05 0650 25 *				164	173	36	210	8	•	
W05 0410 15	15 x D			64	70	34	105	5	•		W05 0650 30 *				196	206	36	245	8	•	
W05 0420 12	12 x D			57	64	34	100	5	•		W05 0660 12 *	6.60	33.0		96	108	36	145	8	•	
W05 0420 25	25 x D	4.20	21.0	106	112	34	150	5	•		W05 0670 12 *	6.70	33.5		96	108	36	145	8	•	
W05 0420 30	30 x D			127	133	34	170	5	•		W05 0680 12 *	6.80	34.0		96	108	36	145	8	•	
W05 0430 12	12 x D	4.30	21.5	57	64	34	100	5	•		W05 0690 12 *	6.90	34.5		96	108	36	145	8	•	
W05 0440 12		4.40	22.0	57	64	34	100	5	•		W05 0700 12 *				96	108	36	145	8	•	
W05 0450 12	12 x D			57	64	34	100	5	•		W05 0700 15 *				107	118	38	160	8	•	
W05 0450 15	15 x D			70	76	34	115	5	•		W05 0700 20 *	7.00	35.0		142	153	38	195	8	•	
W05 0450 20	20 x D	4.50	22.5	92	99	34	135	5	•		W05 0700 25 *				176	187	38	230	8	•	
W05 0450 25	25 x D			114	120	34	155	5	•		W05 0700 30 *				211	222	38	265	8	•	
W05 0450 30	30 x D			136	143	34	180	5	•		W05 0710 12 *	7.10	35.5		96	108	36	145	8	•	
W05 0460 12		4.60	23.0	57	64	34	100	5	•		W05 0720 12 *	7.20	36.0		96	108	36	145	8	•	
W05 0470 12	12 x D	4.70	23.5	57	64	34	100	5	•		W05 0730 12 *	7.30	36.5		96	108	36	145	8	•	
W05 0480 12		4.80	24.0	67	74	34	110	5	•		W05 0740 12 *	7.40	37.0		96	108	36	145	8	•	
W05 0490 12		4.90	24.5	72	81	34	120	5	•		W05 0750 12 *				96	108	36	145	8	•	
W05 0500 12	12 x D			72	81	34	120	5	•		W05 0750 15 *				115	126	38	165	8	•	
W05 0500 15	15 x D			77	85	34	120	5	•		W05 0750 20 *	7.50	37.5		152	163	38	205	8	•	
W05 0500 20	20 x D	5.00	25.0	102	110	34	145	5	•		W05 0750 25 *				189	200	38	240	8	•	
W05 0500 25	25 x D			126	134	34	170	5	•		W05 0750 30 *				226	237	38	280	8	•	
W05 0500 30	30 x D			151	159	34	195	5	•		W05 0760 12 *	7.60	38.0		96	108	36	145	8	•	
W05 0510 12 *	12 x D			72	81	36	120	6	•		W05 0770 12 *	7.70	38.5		96	108	36	145	8	•	
W05 0510 15 *	15 x D	5.10	25.5	79	86	36	125	6	•		W05 0780 12 *	7.80	39.0		96	108	36	145	8	•	
W05 0510 25 *	25 x D			129	136	36	175	6	•		W05 0790 12 *	7.90	39.5		96	108	36	145	8	•	
W05 0510 30 *	30 x D			154	162	36	200	6	•		W05 0800 12 *	8.00	40.0		96	108	36	145	8	•	

* - DIN 6535

cont'd ▶

Remark: I2 is just a guideline for maximum drilling depth, make adjustments accordingly to your machine or workpiece conditions and do not exceed the maximum values. Please find technical info (application) , page 517.

Material Group | Material-Gruppe | Groupe Matière | Gruppo Materiali | 材质主类

N01	N02	N03	K01	K02	P01	P02	P03	M01	M02	S01	S02	S03	H01	H02	O01	O02	Cutting Parameter
																	487 - 490

DR-LX SB OIL FEED TWIST DRILLS - 135° POINT ANGLE -12 X Ø, 15X Ø, 20X Ø, 25X Ø, 30X Ø

VHM DR-LX SB Kühlkanalbohrer nach 135° Spitzenwinkel, Schaft nach DIN 6535HA 12 x Ø, 15x Ø, 20x Ø, 25x Ø, 30x Ø

Punta elicoidali DR-LX SB, con foro di lubrificazione, angolo di punta 135°, codolo DIN 6535HA- 12 x Ø, 15x Ø, 20x Ø, 25x Ø, 30x Ø

Forets hélicoïdaux DR-LX SB à trous d'huile angle de pointe 135°, queue selon DIN 6535HA - 12 x Ø, 15x Ø, 20x Ø, 25x Ø, 30x Ø

整体硬质合金 DR-LX SB 系列 内冷孔钻头-相等于2刃, 柄部标准DIN6535HA, 顶角135° 12 x Ø, 15x Ø, 20x Ø, 25x Ø, 30x Ø

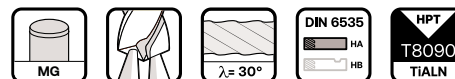

Order Number DIN 6535	Dimension (mm)								T8090	Order Number	Dimension (mm)								T8090
	Hole Depth l2 / D	D (h7)	l1	l2 (Max. Drilling Depth)	l3	l4	L	d2 (h6)			Hole Depth l2 / D	D (h7)	l1	l2 (Max. Drilling Depth)	l3	l4	L	d2 (h6)	
W05 0800 15	15 x D			122	134	40	175	8	•										
W05 0800 20	20 x D			162	174	40	215	8	•										
W05 0800 25	25 x D	8.00	40.0	201	213	40	255	8	•										
W05 0800 30	30 x D			241	253	40	295	8	•										
W05 0810 12 *		0.10	40.5	115	127	40	170	10	•										
W05 0820 12 *		8.10	41.0	120	135	40	180	10	•										
W05 0830 12 *	12 x D	8.20	41.5	120	135	40	180	10	•										
W05 0840 12 *		8.30	42.0	120	135	40	180	10	•										
W05 0850 12 *	12 x D			120	135	40	180	10	•										
W05 0850 15 *	15 x D			130	142	40	185	10	•										
W05 0850 20 *	20 x D	8.50	42.5	172	185	40	230	10	•										
W05 0850 25 *	25 x D			214	226	40	270	10	•										
W05 0850 30 *	30 x D			258	272	40	315	10	•										
W05 0860 12 *		8.60	43.0	120	135	40	180	10	•										
W05 0870 12 *		8.70	43.5	120	135	40	180	10	•										
W05 0880 12 *	12 x D	8.80	44.0	120	135	40	180	10	•										
W05 0890 12 *		8.90	44.5	120	135	40	180	10	•										
W05 0900 12 *	12 x D			120	135	40	180	10	•										
W05 0900 15 *	15 x D			137	151	40	195	10	•										
W05 0900 20 *	20 x D	9.00	45.0	182	196	40	240	10	•										
W05 0900 25 *	25 x D			226	240	40	285	10	•										
W05 0910 12 *		9.10	45.5	120	135	40	180	10	•										
W05 0920 12 *		9.20	46.0	120	135	40	180	10	•										
W05 0930 12 *	12 x D	9.30	46.5	120	135	40	180	10	•										
W05 0940 12 *		9.40	47.0	120	135	40	180	10	•										
W05 0950 12 *	12 x D			120	135	40	180	10	•										
W05 0950 15 *	15 x D	9.50	47.5	145	159	40	200	10	•										
W05 0950 20 *	20 x D			192	206	40	250	10	•										
W05 0960 12 *		9.60	48.0	120	135	40	180	10	•										
W05 0970 12 *	12 x D	9.70	48.5	120	135	40	180	10	•										
W05 0980 12 *	12 x D			120	135	40	180	10	•										
W05 0980 15 *	15 x D	9.80	49.0	149	164	40	205	10	•										
W05 0990 12 *	12 x D	9.90	49.5	120	135	40	180	10	•										
W05 1000 12 *	12 x D			120	135	40	180	10	•										
W05 1000 15 *	15 x D	10.00	50.0	152	167	40	210	10	•										
W05 1000 20 *	20 x D			202	217	40	260	10	•										

* - DIN 6535

Remark: l2 is just a guideline for maximum drilling depth, make adjustments accordingly to your machine or workpiece conditions and do not exceed the maximum values. Please find technical info (application) , page 517.

Material Group | Material-Gruppe | Groupe Matière | Gruppo Materiali | 材质主类

N01 N02 N03 K01 K02 P01 P02 P03 M01 M02 S01 S02 S03 H01 H02 O01 O02

Cutting Parameter

487 - 490

NC SPOT
DR ALU
EZ LINE - DRILL
DR NITCO
DR VA
DR-S
DR MINI
DR-LX
DR 45 SB
DR 60

Recommended Cutting Data



Note: These recommended cutting data indicators are just for reference. They should be adjusted according to the different cutting condition



DR-LX Oil Feed Twist Drills - Point Angle 135°, 12 × D - W05

Working Material	N					
	Wrought Aluminium		Cast Aluminium		Copper Alloy	
Properties	Si < 9%		Si ≥ 9%		-	
D	Vc	fn	Vc	fn	Vc	fn
3.0	120 - 170	0.084	105 - 150	0.083	90 - 140	0.081
4.0		0.120		0.119		0.116
5.0		0.161		0.160		0.155
6.0		0.209		0.203		0.196
7.0		0.259		0.253		0.245
8.0		0.311		0.305		0.298
9.0		0.332		0.323		0.321
10.0		0.351		0.350		0.340
12.0		0.381		0.371		0.365

DR-LX Oil Feed Twist Drills - Point Angle 135°, 12 × D - W05

Working Material	P					
	Carbon Steel		Alloy Steel		Prehardened Steel	
Properties	-		520 < Rm < 1200		35 ≤ HRC < 45	
D	Vc	fn	Vc	fn	Vc	fn
3.0	80 - 120	0.066	65 - 110	0.064	55 - 80	0.063
4.0		0.095		0.092		0.088
5.0		0.126		0.123		0.120
6.0		0.164		0.153		0.153
7.0		0.202		0.189		0.192
8.0		0.245		0.232		0.231
9.0		0.272		0.246		0.249
10.0		0.294		0.263		0.266
12.0		0.339		0.287		0.280

DR-LX Oil Feed Twist Drills - Point Angle 135°, 12 × D - W05

Working Material	K				M			
	Grey Cast Iron		Ductile Cast Iron		Stainless Steel		Stainless Steel	
Properties	-		-		High Machinability		Low Machinability	
D	Vc	fn	Vc	fn	Vc	fn	Vc	fn
3.0	70 - 110	0.067	55 - 80	0.067	50 - 75	0.066	35 - 50	0.062
4.0		0.097		0.094		0.088		
5.0		0.130		0.126		0.113		
6.0		0.164		0.160		0.147		
7.0		0.209		0.200		0.176		
8.0		0.251		0.242		0.218		
9.0		0.262		0.262		0.224		
10.0		0.280		0.273		0.248		
12.0		0.304		0.288		0.267		

NC SPOT
DR ALU
EZ LINE - DRILL
DR NITCO
DR VA
DR-S
DR MINI
DR-LX
DR 45 SB
DR 60

Note: These recommended cutting data indicators are just for reference. They should be adjusted according to the different cutting condition



DR-LX Oil Feed Twist Drills - Point Angle 135°, 12 × D - W05

Working Material	S			
	Titanium alloy		Nickel Alloy	
Properties	-		-	
D	Vc	fn	Vc	fn
3.0	25 - 35	0.062	20 - 30	0.052
4.0		0.088		0.077
5.0		0.112		0.097
6.0		0.158		0.120
7.0		0.190		0.140
8.0		0.234		0.182
9.0		0.242		0.202
10.0		0.252		0.210
12.0		0.280		0.220

DR-LX Oil Feed Twist Drills - Point Angle 135°, 15 × D, 20 × D - W05

Working Material	N					
	Wrought Aluminium		Cast Aluminium		Copper Alloy	
Properties	Si < 9%		Si ≥ 9%		-	
D	Vc	fn	Vc	fn	Vc	fn
3.0	115 - 160	0.102	100 - 140	0.098	85 - 130	0.095
4.0		0.132		0.126		0.123
5.0		0.193		0.186		0.181
6.0		0.227		0.218		0.210
7.0		0.255		0.248		0.248
8.0		0.311		0.304		0.300
9.0		0.340		0.325		0.316
10.0		0.398		0.381		0.370
12.0		0.454		0.437		0.421

DR-LX Oil Feed Twist Drills - Point Angle 135°, 15 × D, 20 × D - W05

Working Material	P					
	Carbon Steel		Alloy Steel		Prehardened Steel	
Properties	-		520 < Rm < 1200		35 ≤ HRC < 45	
D	Vc	fn	Vc	fn	Vc	fn
3.0	75 - 110	0.077	60 - 100	0.076	50 - 70	0.076
4.0		0.101		0.098		0.098
5.0		0.148		0.144		0.144
6.0		0.171		0.168		0.168
7.0		0.193		0.192		0.193
8.0		0.239		0.237		0.242
9.0		0.248		0.256		0.252
10.0		0.295		0.297		0.294
12.0		0.342		0.336		0.336

NC SPOT
DR ALU
EZ LINE -
DRILL
DR NITCO
DR VA
DR-S
DR MINI
DR-LX
DR 45 SB
DR 60

Note: These recommended cutting data indicators are just for reference. They should be adjusted according to the different cutting condition



DR-LX Oil Feed Twist Drills - Point Angle 135°, 15 × D, 20 × D - W05

Working Material	K				M			
	Grey Cast Iron		Ductile Cast Iron		Stainless Steel		Stainless Steel	
Properties	-		-		High Machinability		Low Machinability	
D	Vc	fn	Vc	fn	Vc	fn	Vc	fn
3.0	65 - 100	0.081	50 - 70	0.081	45 - 65	0.073	30 - 45	0.060
4.0		0.105		0.105		0.095		0.078
5.0		0.154		0.154		0.140		0.115
6.0		0.179		0.179		0.161		0.133
7.0		0.204		0.204		0.189		0.147
8.0		0.249		0.255		0.231		0.183
9.0		0.260		0.266		0.249		0.186
10.0		0.309		0.309		0.286		0.227
12.0		0.358		0.358		0.322		0.266

DR-LX Oil Feed Twist Drills - Point Angle 135°, 15 × D, 20 × D - W05

Working Material	S			
	Titanium alloy		Nickel Alloy	
Properties	-		-	
D	Vc	fn	Vc	fn
3.0	20 - 30	0.078	15 - 25	0.049
4.0		0.102		0.063
5.0		0.150		0.091
6.0		0.174		0.109
7.0		0.190		0.116
8.0		0.234		0.154
9.0		0.242		0.171
10.0		0.294		0.196
12.0		0.347		0.218

DR-LX Oil Feed Twist Drills - Point Angle 135°, 25 × D, 30 × D - W05

Working Material	N					
	Wrought Aluminium		Cast Aluminium		Copper Alloy	
Properties	Si < 9%		Si ≥ 9%		-	
D	Vc	fn	Vc	fn	Vc	fn
3.0	100 - 130	0.110	85 - 115	0.107	70 - 100	0.104
4.0		0.150		0.146		0.143
5.0		0.209		0.205		0.199
6.0		0.259		0.251		0.242
7.0		0.309		0.301		0.295
8.0		0.373		0.366		0.359
9.0		0.402		0.389		0.383
10.0		0.445		0.435		0.423
12.0		0.493		0.478		0.466

NC SPOT
 DR ALU
 EZ LINE - DRILL
 DR NITCO
 DR VA
 DR-S
 DR MINI
 DR-LX
 DR 45 SB
 DR 60

Recommended Cutting Data



Note: These recommended cutting data indicators are just for reference. They should be adjusted according to the different cutting condition



DR-LX Oil Feed Twist Drills - Point Angle 135°, 25 × D, 30 × D - W05

Working Material	P					
	Carbon Steel		Alloy Steel		Prehardened Steel	
Properties	-		520 < Rm < 1200		35 ≤ HRC < 45	
D	Vc	fn	Vc	fn	Vc	fn
3.0	60 - 85	0.085	45 - 70	0.083	35 - 45	0.082
4.0		0.117		0.114		0.111
5.0		0.162		0.158		0.156
6.0		0.200		0.191		0.191
7.0		0.238		0.228		0.231
8.0		0.291		0.281		0.283
9.0		0.314		0.301		0.300
10.0		0.354		0.333		0.333
12.0		0.408		0.369		0.364

DR-LX Oil Feed Twist Drills - Point Angle 135°, 25 × D, 30 × D - W05

Working Material	K				M			
	Grey Cast Iron		Ductile Cast Iron		Stainless Steel		Stainless Steel	
Properties	-		-		High Machinability		Low Machinability	
D	Vc	fn	Vc	fn	Vc	fn	Vc	fn
3.0	50 - 75	0.088	35 - 45	0.088	30 - 40	0.082	20 - 30	0.073
4.0		0.120		0.118		0.113		0.101
5.0		0.168		0.165		0.155		0.137
6.0		0.204		0.201		0.191		0.169
7.0		0.248		0.242		0.228		0.197
8.0		0.300		0.297		0.279		0.245
9.0		0.313		0.316		0.298		0.250
10.0		0.351		0.346		0.324		0.287
12.0		0.392		0.381		0.370		0.320

DR-LX Oil Feed Twist Drills - Point Angle 135°, 25 × D, 30 × D - W05

Working Material	S			
	Titanium alloy		Nickel Alloy	
Properties	-		-	
D	Vc	fn	Vc	fn
3.0	15 - 25	0.082	15 - 20	0.061
4.0		0.113		0.085
5.0		0.153		0.113
6.0		0.198		0.139
7.0		0.228		0.156
8.0		0.281		0.204
9.0		0.291		0.227
10.0		0.323		0.245
12.0		0.370		0.263

NC SPOT
DR ALU
EZ LINE - DRILL
DR NITCO
DR VA
DR-S
DR MINI
DR-LX
DR 45 SB
DR 60

FEATURES & BENEFITS

DR 45 SB

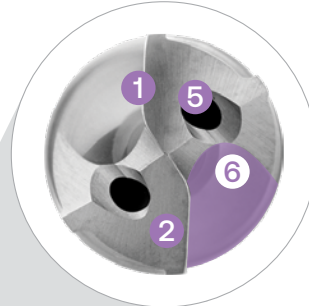

1 Split Point Design

Provides self centering ability and reduced thrust

3 Effective Clearance and Gash

Ensures fast, efficient chips evacuation and drastically reduces built-up edge

5 Oil Hole V-Groove

Improves the flushing out of chips during drilling

7 Suitable for Material



9 Four Margin for Optimum Hole Quality

- Improve holes straightness
- Better holes tolerance
- Using on inclined hole exit
- Workpiece with cross holes

2 Straight Cutting Edge

- Produces small chips
- Improves chip evacuation

4 Corner Reinforcement

Adds protection during the drilling process

6 J Flute Shape

Provides better chip evacuation

8 Polished Flutes Passage

- Provides better chips evacuation
- Increases feeds and speeds possible for high performance drilling
- Less built-up edge

10 High Performance Drill with Internal Coolant

- Enhances hole quality
- Increases tool durability





1. Kreuzanschiff
Bietet Selbstzentrierung und reduzierten Axialdruck
2. Gerade Schneide
Erzeugt kleine Späne
verbessert den Spanabgang
3. Effektiver Abstand und Schnitt
Niedrigere Schnittkräfte
Verbessert die Spanbildung und Kontrolle
4. Schneideckenverstärkung
sorgt für mehr Schutz beim Bohren
5. Kühlkanäle in V-Stirnanschiff
besseres Ausspülen der Späne während des Bohrens
6. J-förmige Nuten
bietet einen verbesserten Spänefluß
7. Geeignet für die Materialgruppen P, M, K, S
8. Polierter Nutenübergang
Bietet einen verbesserten Spänefluß
Erhöht Vorschübe und Schnittgeschwindigkeiten beim Hochleistungsbohren
Weniger Aufbauschneiden
9. Vier Fasen für optimale Bohrungsqualität
Verbessert die Geradheit der Bohrung
Bessere Bohrungstoleranz
Einsatz bei schrägem Bohrausgang
Werkstücke mit Kreuzbohrungen
10. Hochleistungsbohrer mit Innenkühlung
Verbessert die Bohrungsqualität
Erhöht die Haltbarkeit des Werkzeugs



1. 不等分设计
提供自定心能力和减小推力。
2. 垂直切削刃
产生小碎屑。
改善排屑。
3. 有效排屑能力
加工切削阻力较低。
改善碎屑的形成和控制。
4. 刀尖加固
在钻孔过程中增加保护。
5. 油孔 V 型槽
改善钻孔过程中对碎屑的冲洗。
6. J 型槽
提供更好的排屑。
7. 适用于材料 P、M、K、S
8. 抛光排屑槽
提供更好的排屑。
提高切削速率, 实现高性能钻孔。
减少铁屑堆积。
9. 四个边刃, 确保最佳孔质量
提高孔垂直度。
更好的孔公差。
在倾斜孔出口使用。
带十字孔的工件。
10. 具有内冷却的高性能钻头
提高钻孔质量。
提高刀具耐用性。



1. Struttura del punto di ripartizione
Offre capacità autocentranti e spinta ridotta
2. Angolo di taglio dritto
Produce piccoli trucioli
Migliora l'evacuazione dei trucioli
3. Gioco e sgrassatura efficaci
Forze di taglio inferiori
Migliora la formazione e il controllo dei trucioli
4. Rafforzamento degli angoli
Aggiunge protezione durante il processo di foratura
5. Scanalatura a V del foro dell'olio
Migliora l'espulsione dei trucioli durante la foratura
6. Forma della scanalatura a J
Offre una migliore evacuazione dei trucioli
7. Adatto per il materiale P, M, K, S
8. Passaggio scanalature levigate
Offre una migliore evacuazione dei trucioli
Aumenta l'avanzamento e la velocità per una foratura ad alte prestazioni
Meno formazione di materiale di riporto
9. Quattro margini per una qualità dei fori ottimale
Migliora la linearità dei fori
Migliore tolleranza dei fori
Utilizzo su uscita foro inclinata
Pezzo con fori trasversali
10. Foratura ad alte prestazioni con liquido refrigerante interno
Migliora la qualità dei fori
Aumenta la resistenza dello strumento



1. Conception à affûtage 4 faces croisées
auto centrant, efforts de coupes réduit
2. Affûtage 4 faces croisées
Produit des copeaux de petite taille
Améliore l'évacuation des copeaux
3. Dégagement et rainure de logement efficaces
Forces de coupe inférieures
Améliore la formation et le contrôle des copeaux
4. Rayon torique sur les arêtes
pour une meilleur protection pendant le perçage
5. Scanalatura a V del foro dell'olio
Migliora l'espulsione dei trucioli durante la foratura
6. Forma della scanalatura a J
Offre una migliore evacuazione dei trucioli
7. Adapté aux matériaux P, M, K, S
8. Goujure poli
Permet une meilleure évacuation des copeaux
Améliore les débits et les vitesses possibles pour un perçage haute performance
Moins de collage sur les arêtes
9. Foret double listel pour qualité de trou
Améliore la rectitude des percages
Meilleure tolérance des trous
Utilisation pour trou débouchant sur une inclinaison
Peut être utilisé pour trous sécants
10. Perçage haute performance à trou d'huile
Améliore la qualité des percages
Augmente la durée de vie de l'outil

DR 45 SB LONG OF SPIRAL BURNISHING DRILLS - 140° POINT ANGLE - 8 X Ø

- VHM DR 45 SB OF Lange 4 Fasen-Spiralbohrer nach HPMT Norm, mit Kühlkanälen - 140° Spitzenwinkel, Schaft nach DIN 6535HA
- Punta elicoidali DR 45 SB OF a doppio margine, norma HPMT, con foro di lubrificazione, angolo di punta 140°, codolo DIN 6535HA - 8 x Ø
- DR 45 SB OF Foret hélicoïdal double listel à trou d'huile, selon norme HPMT, queue DIN 6535HA - 8 x Ø
- 整体硬质合金DR 45 SB LONG OF 螺旋精加工钻头- 加工深度5xD, 柄部标准DIN6535HA, 顶角140°

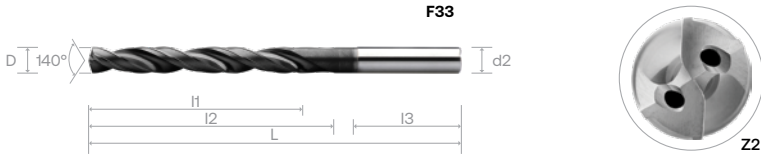
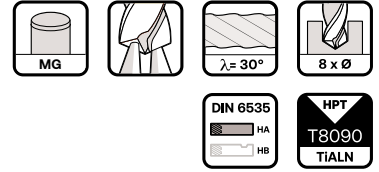

Order Number	DIN 6535	Dimension (mm)						T8090	Order Number	DIN 6535	Dimension (mm)						T8090										
		D (m7)	I1	I2	I3	L	d2 (h6)				D (m7)	I1	I2	I3	L	d2 (h6)											
F33 0300 085 03		3.0		40	36	85	3	•	F33 0730	*	7.3		76	36	116	8	•	F33 1600	*	16.0		152	48	204	16	•	
F33 0300	*			40	36	85	6	◦	F33 0740	*	7.4		76	36	116	8	◦	F33 1450	*	14.5		152	48	204	16	•	
F33 0310 085 03		3.1		40	36	85	3	•	F33 0750	*	7.5		76	36	116	8	•	F33 1300	*	13.0		133	45	182	14	•	
F33 0310	*			40	36	85	6	•	F33 0760	*	7.6		76	36	116	8	◦	F33 1270	*	12.7		133	45	182	14	◦	
F33 0320 085 03		3.2	32	40	36	85	3	◦	F33 0770	*	7.7		76	36	116	8	◦	F33 1280	*	12.8		133	45	182	14	◦	
F33 0320	*			40	36	85	6	◦	F33 0780	*	7.8		76	36	116	8	•	F33 1300	*	13.0		133	45	182	14	•	
F33 0330	*	3.3		40	36	85	6	◦	F33 0790	*	7.9		76	36	116	8	◦	F33 1350	*	13.5		133	45	182	14	•	
F33 0340	*	3.4		40	36	85	6	•	F33 0800	*	8.0		76	36	116	8	•	F33 1370	*	13.7		133	45	182	14	◦	
F33 0350	*	3.5		40	36	85	6	•	F33 0810 116 08	*	8.1		76	36	116	8	◦	F33 1400	*	14.0		133	45	182	14	◦	
F33 0360	*	3.6		40	36	85	6	◦	F33 0810	*			95	40	142	10	•	F33 1450	*	14.5		152	48	204	16	•	
F33 0370	*	3.7		40	36	85	6	•	F33 0820	*	8.2		95	40	142	10	•	F33 1500	*	15.0		152	48	204	16	◦	
F33 0380	*	3.8	36	40	36	85	6	◦	F33 0830	*	8.3		95	40	142	10	•	F33 1550	*	15.5		152	48	204	16	◦	
F33 0390	*	3.9		40	36	85	6	•	F33 0840	*	8.4		95	40	142	10	◦	F33 1600	*	16.0		152	48	204	16	•	
F33 0400 085 04		4.0		40	36	85	4	◦	F33 0850	*	8.5		95	40	142	10	•										
F33 0400	*		38	46	36	85	6	•	F33 0860	*	8.6		95	40	142	10	◦										
F33 0410 085 04		4.1		36	40	36	85	4	◦	F33 0870	*	8.7		95	40	142	10	•									
F33 0410	*			38	46	36	85	6	◦	F33 0880	*	8.8		95	40	142	10	◦									
F33 0420 085 04		4.2		36	40	36	85	4	◦	F33 0890	*	8.9		95	40	142	10	◦									
F33 0420	*			38	46	36	85	6	◦	F33 0900	*	9.0		95	40	142	10	•									
F33 0430	*	4.3		46	36	97	6	◦	F33 0910	*	9.1		95	40	142	10	◦										
F33 0440	*	4.4	40	46	36	97	6	◦	F33 0920	*	9.2		95	40	142	10	◦										
F33 0450	*	4.5		46	36	97	6	◦	F33 0930	*	9.3		95	40	142	10	◦										
F33 0460	*	4.6		46	36	97	6	•	F33 0940	*	9.4		95	40	142	10	◦										
F33 0470	*	4.7	44	46	36	97	6	◦	F33 0950	*	9.5		95	40	142	10	•										
F33 0480	*	4.8		46	36	97	6	•	F33 0960	*	9.6		95	40	142	10	◦										
F33 0490	*	4.9		46	36	97	6	◦	F33 0970	*	9.7		95	40	142	10	•										
F33 0500	*	5.0		57	36	97	6	•	F33 0980	*	9.8		95	40	142	10	•										
F33 0510	*	5.1		57	36	97	6	◦	F33 0990	*	9.9		95	40	142	10	◦										
F33 0520	*	5.2		57	36	97	6	◦	F33 1000	*	10.0		95	40	142	10	◦										
F33 0530	*	5.3		57	36	97	6	•	F33 1020	*	10.2		114	45	163	12	•										
F33 0540	*	5.4		57	36	97	6	◦	F33 1050	*	10.5		114	45	163	12	•										
F33 0550	*	5.5	48	57	36	97	6	•	F33 1080	*	10.8		114	45	163	12	◦										
F33 0560	*	5.6		57	36	97	6	◦	F33 1100	*	11.0		114	45	163	12	•										
F33 0570	*	5.7		57	36	97	6	◦	F33 1120	*	11.2		114	45	163	12	•										
F33 0580	*	5.8		57	36	97	6	•	F33 1130	*	11.3		114	45	163	12	◦										
F33 0590	*	5.9		57	36	97	6	◦	F33 1150	*	11.5		114	45	163	12	•										
F33 0600	*	6.0		57	36	97	6	•	F33 1180	*	11.8		114	45	163	12	•										
F33 0610 097 06	*	6.1		57	36	97	6	◦	F33 1200	*	12.0		114	45	163	12	◦										
F33 0610	*			76	36	116	8	•	F33 1220	*	12.2		133	45	182	14	◦										
F33 0620	*	6.2		76	36	116	8	•	F33 1250	*	12.5		133	45	182	14	•										
F33 0630	*	6.3		76	36	116	8	•	F33 1270	*	12.7		133	45	182	14	◦										
F33 0640	*	6.4		76	36	116	8	•	F33 1280	*	12.8		133	45	182	14	◦										
F33 0650	*	6.5		76	36	116	8	•	F33 1300	*	13.0		133	45	182	14	•										
F33 0660	*	6.6		76	36	116	8	•	F33 1350	*	13.5		133	45	182	14	•										
F33 0670	*	6.7	64	76	36	116	8	•	F33 1370	*	13.7		133	45	182	14	◦										
F33 0680	*	6.8		76	36	116	8	•	F33 1400	*	14.0		133	45	182	14	◦										
F33 0690	*	6.9		76	36	116	8	•	F33 1450	*	14.5		152	48	204	16	•										
F33 0700	*	7.0		76	36	116	8	•	F33 1500	*	15.0		152	48	204	16	◦										
F33 0710	*	7.1		76	36	116	8	•	F33 1550	*	15.5		152	48	204	16	◦										
F33 0720	*	7.2		76	36	116	8	•	F33 1600	*	16.0		152	48	204	16	•										

* - DIN 6535

Material Group | Material-Gruppe | Groupe Matière | Gruppo Materiali | 材质主类

N01	N02	N03	K01	K02	P01	P02	P03	M01	M02	S01	S02	S03	H01	H02	O01	O02	Cutting Parameter
			●	●	●	●	●	○	○	●	●						494

Recommended Cutting Data



Note: These recommended cutting data indicators are just for reference. They should be adjusted according to the different cutting condition



DR 45 SB Oil Feed Spiral Burnishing Drills, 8xD, 2 Flutes - F33

Drilling	K				P					
Working Material	Grey Cast Iron		Ductile Cast Iron		Carbon Steel		Alloy Steel		Prehardened Steel	
Properties	-		-		-		520 < Rm < 1200		35 ≤ HRC < 45	
D	Vc	fn	Vc	fn	Vc	fn	Vc	fn	Vc	fn
3		0.058		0.050		0.062		0.054		0.053
4		0.082		0.067		0.086		0.073		0.072
5		0.107		0.085		0.110		0.094		0.091
6		0.132		0.106		0.136		0.114		0.110
7		0.158		0.122		0.162		0.135		0.130
8		0.182		0.150		0.187		0.155		0.152
9		0.210		0.165		0.212		0.175		0.172
10	120	0.235	55	0.188		0.240	105	0.200	95	0.192
11		0.265		0.210		0.272		0.218		0.215
12		0.302		0.240		0.307		0.250		0.242
13		0.315		0.250		0.321		0.262		0.258
14		0.333		0.260		0.340		0.282		0.276
15		0.348		0.270		0.352		0.295		0.288
16		0.366		0.282		0.370		0.315		0.312



DR 45 SB Oil Feed Spiral Burnishing Drills, 8xD, 2 Flutes - F33

Drilling	M				S			
Working Material	Stainless Steel		Stainless Steel		Titanium Alloy		Nickel Alloy	
Properties	High Machinability		Low Machinability		-		-	
D	Vc	fn	Vc	fn	Vc	fn	Vc	fn
3		0.050		0.046		0.031		0.028
4		0.067		0.061		0.042		0.035
5		0.085		0.080		0.052		0.050
6		0.105		0.091		0.065		0.060
7		0.125		0.112		0.081		0.070
8		0.145		0.135		0.092		0.080
9		0.160		0.145		0.105		0.090
10	60	0.180	40	0.175	35	0.115	30	0.100
11		0.205		0.185		0.125		0.110
12		0.235		0.210		0.150		0.130
13		0.245		0.225		0.155		0.135
14		0.258		0.230		0.165		0.143
15		0.270		0.242		0.170		0.148
16		0.285		0.265		0.180		0.155

NC SPOT
DR ALU
EZ LINE - DRILL
DR NITCO
DR VA
DR-S
DR MINI
DR-LX
DR 45 SB
DR 60

FEATURES & BENEFITS

DR 60

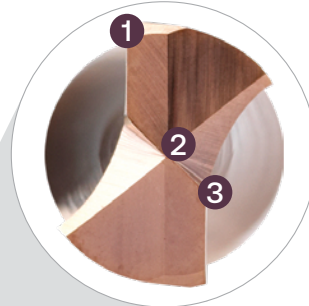

1 Corner Chamfer Edge

Edge protection when machining on hardened material

2 Thinning

Special Thinning for hardened material

3 Bigger Web Thickness

Increases the tool rigidity

4 Tough PVD Silicon Based Coating

- Prolong the tool life
- Enables higher cutting speeds
- Increases heat resistance

5 Suitable for Material Group

H





1. Eckenschutzfase
Kantenschutz bei der Bearbeitung von gehärtetem Material
2. Ausspitzung
Spezielle Stirnausspitzung für gehärtetes Material
3. Größerer Kerndurchmesser
Erhöht die Werkzeugsteifigkeit
4. Robuste PVD-Siliziumbeschichtung
verlängert die Werkzeuglebensdauer
ermöglicht höhere Schnittgeschwindigkeiten
verbesserte Hitzebeständigkeit
5. Geeignet für die Materialgruppen H



1. 刀尖倒角设计
在硬化材料上进行加工时的边刃保护。
2. 变薄
硬化材料特殊变薄。
3. 更大的腹板厚度
提高刀具刚性。
4. 耐用的 PVD 硅基涂层
延长刀具寿命。
实现更高的切削速率。
增加耐热性。
5. 适用于材料 H



1. Tagliente di smusso
Protezione degli angoli durante la lavorazione su materiali induriti
2. Assottigliamento
Assottigliamento specifico per materiale indurito
3. Spessore del nocciolo più grande
Aumenta la rigidità dello strumento
4. Rivestimento in silicone PVD resistente
Prolunga la vita dello strumento
Consente maggiori velocità di taglio
Aumenta la resistenza al calore
5. Adatto per il materiale H



1. Rayon torique sur les arêtes
Protection de l'arête lors de l'usinage de matériaux plus durs
2. Amincissement
Amincissement spécial pour les matériaux durcis
3. Ame renforcée
Augmente la rigidité de l'outil
4. Revêtement à base de silicium sous forme de dépôt en phase vapeur résistant
Prolonge la durée de vie de l'outil
Permet des vitesses de coupe supérieures
Augmente la résistance à la chaleur
5. Adapté aux matériaux H

DR 60 TWIST DRILLS - DIN 6537L - 150° POINT ANGLE - 5 X Ø

- VHM Spiralbohrer nach DIN 6537L, 150° Spitzenwinkel, Schaft nach DIN 6535HA
- Punte elicoidali a norma DIN 6537L, 5 x ø, con angolo di punta 150°, codolo DIN 6535HA
- Forets hélicoïdaux selon DIN 6537L - 5 x Ø, angle de pointe 150°, queue selon DIN 6535HA
- 整体硬质合金钻头-相等于DIN 6537L 2刃-加工深度3xD, 柄部标准DIN 6535HA, 顶角150°

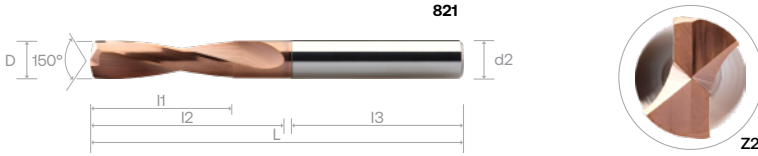

NC SPOT
 DR ALU
 EZ LINE - DRILL
 DR NITICO
 DR VA
 DR-S
 DR MINI
 DR-LX
 DR 45 SB
 DR 60

Order Number DIN 6535	Dimension (mm)						D0120
	D (m7)	I1	I2	I3	L	d2 (h6)	
821 0300 *	3.0	23	28	36	66	6	o
821 0330 *	3.3		28	36	66	6	o
821 0350 *	3.5	29	28	36	66	6	o
821 0380 *	3.8		36	36	74	6	o
821 0400 *	4.0	35	36	36	74	6	o
821 0420 *	4.2		36	36	74	6	o
821 0450 *	4.5	43	36	36	82	6	o
821 0480 *	4.8		44	36	82	6	o
821 0500 *	5.0	49	44	36	82	6	o
821 0550 *	5.5		44	36	82	6	o
821 0580 *	5.8	56	44	36	82	6	o
821 0600 *	6.0		44	36	82	6	o
821 0650 *	6.5	60	53	36	91	8	o
821 0680 *	6.8		53	36	91	8	o
821 0700 *	7.0	43	53	36	91	8	o
821 0750 *	7.5		53	36	91	8	o
821 0780 *	7.8	49	53	36	91	8	o
821 0800 *	8.0		53	36	91	8	o
821 0850 *	8.5	56	61	40	103	10	o
821 0880 *	8.8		61	40	103	10	o
821 0900 *	9.0	60	61	40	103	10	o
821 0950 *	9.5		61	40	103	10	o
821 0980 *	9.8	49	61	40	103	10	o
821 1000 *	10.0		61	40	103	10	o
821 1020 *	10.2	56	71	45	118	12	o
821 1050 *	10.5		71	45	118	12	o
821 1080 *	10.8	60	71	45	118	12	o
821 1100 *	11.0		71	45	118	12	o
821 1150 *	11.5	49	71	45	118	12	o
821 1180 *	11.8		71	45	118	12	o
821 1200 *	12.0	56	71	45	118	12	o
821 1250 *	12.5		77	45	124	14	o
821 1280 *	12.8	60	77	45	124	14	o
821 1300 *	13.0		77	45	124	14	o

* - DIN 6535

Material Group | Material-Gruppe | Groupe Matière | Gruppo Materiali | 材质主类

N01
N02
N03
K01
K02
P01
P02
P03
M01
M02
S01
S02
S03
H01
H02
O01
O02

Cutting Parameter

499

DR 60 TWIST DRILLS - DIN 6537K - 150° POINT ANGLE - 3 X Ø

- VHM Spiralbohrer nach DIN 6537K, 150° Spitzenwinkel, Schaft nach DIN 6535HA
- Punte elicoidali a norma DIN 6537K, 3 x ø, con angolo di punta 150°, codolo DIN 6535HA
- Forets hélicoïdaux selon DIN 6537K - 3 x Ø, angle de pointe 150°, queue selon DIN 6535HA
- 整体硬质合金钻头-相等于DIN 6537K 2刃-加工深度3xD, 顶角150°

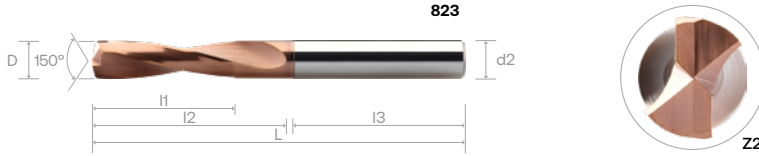
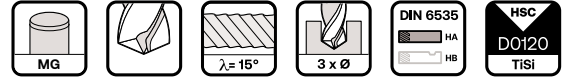

Order Number DIN 6535	Dimension (mm)						D0120
	D (m7)	I1	I2	I3	L	d2 (h6)	
823 0300 *	3.0		20	36	62	6	o
823 0330 *	3.3	14	20	36	62	6	•
823 0350 *	3.5		20	36	62	6	•
823 0380 *	3.8		24	36	66	6	•
823 0400 *	4.0	17	24	36	66	6	•
823 0420 *	4.2		24	36	66	6	•
823 0450 *	4.5		24	36	66	6	•
823 0480 *	4.8		28	36	66	6	o
823 0500 *	5.0	20	28	36	66	6	o
823 0550 *	5.5		28	36	66	6	•
823 0580 *	5.8		28	36	66	6	•
823 0600 *	6.0		28	36	66	6	•
823 0650 *	6.5		34	36	79	8	•
823 0680 *	6.8		41	36	79	8	•
823 0700 *	7.0	29	41	36	79	8	•
823 0750 *	7.5		41	36	79	8	•
823 0780 *	7.8		41	36	79	8	o
823 0800 *	8.0		41	36	79	8	•
823 0850 *	8.5		47	40	89	10	•
823 0880 *	8.8		47	40	89	10	•
823 0900 *	9.0	35	47	40	89	10	o
823 0950 *	9.5		47	40	89	10	o
823 0980 *	9.8		47	40	89	10	o
823 1000 *	10.0		47	40	89	10	•
823 1020 *	10.2		55	45	102	12	o
823 1050 *	10.5		55	45	102	12	o
823 1080 *	10.8		55	45	102	12	•
823 1100 *	11.0	40	55	45	102	12	o
823 1150 *	11.5		55	45	102	12	o
823 1180 *	11.8		55	45	102	12	•
823 1200 *	12.0		55	45	102	12	•
823 1250 *	12.5		60	45	107	14	o
823 1280 *	12.8	43	60	45	107	14	o
823 1300 *	13.0		60	45	107	14	o

* - DIN 6535

NC SPOT
 DR ALU
 EZ LINE - DRILL
 DR NITCO
 DR VA
 DR-S
 DR MINI
 DR-LX
 DR 45 SB
DR 60

Material Group | Material-Gruppe | Groupe Matière | Gruppo Materiali | 材质主类

N01	N02	N03	K01	K02	P01	P02	P03	M01	M02	S01	S02	S03	H01	H02	O01	O02
-----	-----	-----	-----	-----	-----	-----	-----	-----	-----	-----	-----	-----	-----	-----	-----	-----

Cutting Parameter

499

Note: These recommended cutting data indicators are just for reference. They should be adjusted according to the different cutting condition



H



DR 60 Twist Drills, 3xD & 5xD, 2 Flutes - 821, 823

Drilling	H			
Working Material	Hardened Steel		Hardened Steel	
Properties	45 ≤ HRC < 52		52 ≤ HRC < 68	
D	Vc	fn	Vc	fn
3	30	0.024	20	0.018
4		0.050		0.025
5		0.065		0.029
6		0.080		0.032
7		0.090		0.036
8		0.100		0.039
9		0.110		0.043
10		0.120		0.046
11		0.130		0.050
12		0.140		0.053
13		0.150		0.059

NC SPOT

DR ALU

EZ LINE -
DRILL

DR NITCO

DR VA

DR-S

DR MINI

DR-LX

DR 45 SB

DR 60





DRILL

RE 45

For material application is ≤ 45 HRC

Index RE 45, For ≤ 45 HRC

 Suitable for Material Groups





 Adapté pour les matériaux

 适用于材料

 Geeignet für die Materialgruppen

 Adatto per il materiale



EDP Number	Type	No. Z	Helix Angle	Coating	Performance	Page Number
621	 RE 45 Short	4/6	-	UC	G	502
623	 RE 45 L.H. / R.H. Short	4/6	12°	UC	G	503
625	 RE 45 R.H. DIN 212	4/6	-	UC	G	504
627	 RE 45 L.H. / R.H. DIN 212	4/6	12°	UC	G	505
629	 RE 45 HIGH L.H. / R.H. DIN 212	3/4/6	60°	UC	G	506

G - General P - Performance

RE 45 SHORT MACHINE REAMERS STRAIGHT FLUTES, 4 - 6 FLUTES

- VHM RE 45 Maschinenreibahnen, kurz, gerade Nuten, 4 bzw. 6 Schneiden
- Alesatori a macchina corti RE 45, con gole diritte, 4 - 6 taglienti
- Alésoirs machine RE 45 courts, dents droites, 4 - 6 dents
- 整体硬质合金 RE 45 系列 4/6刃螺旋槽铰刀(带颈位)



RE 45

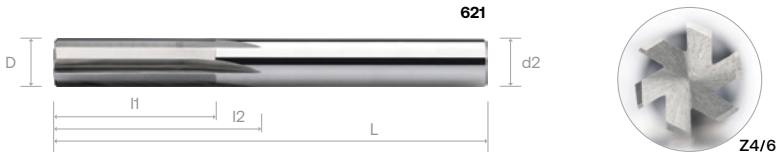

Order Number	Dimension (mm)						UC
	D (H7)	I1	I2	L	d2 (h9)	Z	
621 0150	1.5	9.5	11/15*	38	2	4	○
621 0200	2	12.5	14.5	44	2	4	●
621 0250	2.5	16	18.5	57	2.5	4	○
621 0300	3		19	57	3	4	●
621 0350	3.5	19	22.5	63	3.5	4	○
621 0400	4		23	63	4	4	●
621 0450	4.5	22	26.5	70	4.5	6	○
621 0500	5	25.5	30.5	76	5	6	○
621 0550	5.5		31	76	5.5	6	○
621 0600	6	28.5	31.5	76	6	6	○
621 0650	6.5		35	83	6.5	6	○
621 0700	7	35.5	83	7	6	●	
621 0750	7.5	36	83	7.5	6	○	
621 0800	8	32	36.5	83	8	6	○
621 0850	8.5		40.5	89	8.5	6	○
621 0900	9	35	41	89	9	6	○
621 0950	9.5		41.5	89	9.5	6	○
621 1000	10	38	42	89	10	6	○
621 1050	10.5		42.5	89	10.5	6	○
621 1100	11	44.5	46	95	11	6	○
621 1150	11.5		46.5	95	11.5	6	○
621 1200	12	38	47	95	12	6	○
621 1300	13		51	102	13	6	○
621 1400	14	44.5	52	102	14	6	○
621 1500	15		53	102	15	6	○
621 1600	16	54	102	16	6	○	

* - DIN 6535

Material Group | Material-Gruppe | Groupe Matière | Gruppo Materiali | 材质主类

Cutting Parameter

N01
 N02
 N03
 K01
 K02
 P01
 P02
 P03
 M01
 M02
 S01
 S02
 S03
 H01
 H02
 O01
 O02

507

RE 45 SHORT MACHINE REAMERS 12° LEFT HAND HELIX RIGHT HAND CUT, 4 - 6 FLUTES

RE 45

- VHM RE 45 Maschinenreibahlen, kurz, 12° Linksdrall, rechtsschneidend, doppelter Anschliff 4 bzw. 6 Schneiden
- Alesatori a macchina corti RE 45, con elica 12° sinistra, taglio a destra, doppio imbocco, 4 - 6 taglianti
- Alésoirs machine RE 45 courts, hélice 12° à gauche, coupe à droite double entrée 4 - 6 dents
- 整体硬质合金 RE 45 系列 4/6刃螺旋槽铰刀(带颈位)

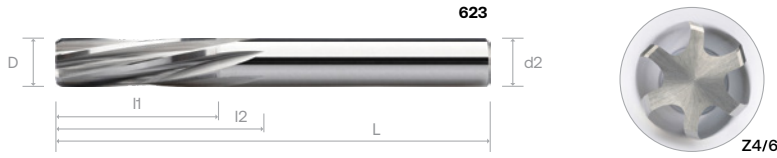

Order Number	Dimension (mm)						UC
	D (H7)	l1	l2	L	d2 (h9)	Z	
623 0150	1.5	9.5	11/15*	38		4	•
623 0200	2	12.5	14.5	44	2	4	•
623 0250	2.5	16	18.5	57	2.5	4	◦
623 0300	3		19	57	3	4	•
623 0350	3.5	19	22.5	63	3.5	4	◦
623 0400	4		23	63	4	4	•
623 0450	4.5	22	26.5	70	4.5	6	◦
623 0500	5	25.5	30.5	76	5	6	◦
623 0550	5.5		31	76	5.5	6	•
623 0600	6	28.5	31.5	76	6	6	•
623 0650	6.5		35	83	6.5	6	•
623 0700	7	28.5	35.5	83	7	6	◦
623 0750	7.5		36	83	7.5	6	◦
623 0800	8	32	36.5	83	8	6	◦
623 0850	8.5		40.5	89	8.5	6	◦
623 0900	9	32	41	89	9	6	◦
623 0950	9.5		41.5	89	9.5	6	◦
623 1000	10	35	42	89	10	6	◦
623 1050	10.5		42.5	89	10.5	6	◦
623 1100	11	35	46	95	11	6	◦
623 1150	11.5		46.5	95	11.5	6	◦
623 1200	12	38	47	95	12	6	◦
623 1300	13		51	102	13	6	•
623 1400	14	44.5	52	102	14	6	◦
623 1500	15		53	102	15	6	◦
623 1600	16	54	102	16	6	•	

* - DIN 6535

Material Group | Material-Gruppe | Groupe Matière | Gruppo Materiali | 材质主类

Cutting Parameter

N01	N02	N03	K01	K02	P01	P02	P03	M01	M02	S01	S02	S03	H01	H02	O01	O02	507
-----	-----	-----	-----	-----	-----	-----	-----	-----	-----	-----	-----	-----	-----	-----	-----	-----	-----

RE 45 MACHINE REAMERS ACC. TO DIN 212, STRAIGHT FLUTES, 4 - 6 FLUTES

- VHM RE 45 Maschinenreibahnen nach DIN 212, gerade Nuten, 4 bzw. 6 Schneiden
- Alesatori a macchina RE 45, DIN 212, 4 - 6 taglienti
- Alésoirs machine RE 45 selon DIN 212, dents droites, 4 - 6 dents
- 整体硬质合金 RE 45 系列 4/6刃直槽铰刀(带颈位) ~DIN 212



RE 45

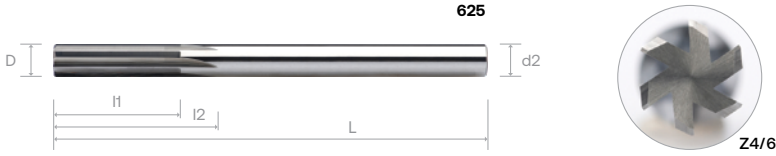

Order Number	Dimension (mm)						UC
	D (H7)	l1	l2	L	d2 (h9)	Z	
625 0200	2	11	13	49	2	4	•
625 0250	2.5	14	16.5	57	2.5	4	◦
625 0300	3	15	18	61	3	4	◦
625 0350	3.5	18	21.5	70	3.5	4	◦
625 0400	4	19	23	75	4	4	•
625 0450	4.5	21	25.5	49	4.5	6	◦
625 0500	5	23	28	57	5	6	•
625 0550	5.5	26	31.5	61	5.5	6	◦
625 0600	6		32	70	6	6	◦
625 0650	6.5	28	34.5	75	6.5	6	◦
625 0700	7		38	83	7	6	◦
625 0750	7.5	31	38.5	83	7.5	6	◦
625 0800	8		41	83	8	6	◦
625 0850	8.5	33	41.5	89	8.5	6	◦
625 0900	9		45	89	9	6	◦
625 0950	9.5	36	45.5	89	9.5	6	◦
625 1000	10		48	89	10	6	•
625 1050	10.5	38	48.5	89	10.5	6	◦
625 1100	11		52	95	11	6	◦
625 1150	11.5	41	52.5	95	11.5	6	◦
625 1200	12		56	95	12	6	◦
625 1300	13	44	57	102	13	6	◦
625 1400	14	47	61	102	14	6	◦
625 1500	15	50	65	102	15	6	◦
625 1600	16	52	68	102	16	6	◦

Material Group | Material-Gruppe | Groupe Matière | Gruppo Materiali | 材质主类

Cutting Parameter

N01
 N02
 N03
 K01
 K02
 P01
 P02
 P03
 M01
 M02
 S01
 S02
 S03
 H01
 H02
 O01
 O02

507

RE 45 MACHINE REAMERS ACC. TO DIN 212, 12° L.H. HELIX, R.H. CUT, DOUBLE LEAD ENTRANCE, 4 - 6 FLUTES

RE 45

- VHM RE 45 Maschinenreibahlen, kurz, 12° Linksdrall, rechtsschneidend, doppelter Anschitt 4 bzw. 6 Schneiden
- Alesatori a macchina corti RE 45, con elica 12° sinistra, taglio a destra, doppio imbocco, 4 - 6 taglienti
- Alésoids machine RE 45 courts, hélice 12° à gauche, coupe à droite double entrée 4 - 6 dents
- 整体硬质合金 RE 45 系列 4/6刃螺旋槽铰刀(带颈位)

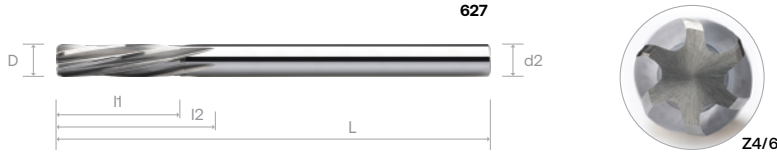

Order Number	Dimension (mm)						UC	Order Number	Dimension (mm)						UC
	D (H7)	l1	l2	L	d2 (H9)	Z			D (H7)	l1	l2	L	d2 (H9)	Z	
627 0200	2	11	13	49	2	4	•	627 0650	6.5	28	34.5	101	6.5	6	•
627 0210	2.1		13	49	2.1	4	•	627 0660	6.6		34.5	101	6.6	6	•
627 0220	2.2	14	16.5	57	2.2	4	•	627 0670	6.7	31	38	109	6.7	6	•
627 0230	2.3		16.5	57	2.3	4	•	627 0680	6.8		38	109	6.8	6	•
627 0240	2.4	15	16.5	57	2.4	4	•	627 0690	6.9	33	38	109	6.9	6	•
627 0250	2.5		16.5	57	2.5	4	•	627 0700	7		38	109	7	6	•
627 0260	2.6	18	16.5	57	2.6	4	•	627 0710	7.1	36	38	109	7.1	6	•
627 0270	2.7		16.5	61	2.7	4	•	627 0720	7.2		38	109	7.2	6	•
627 0280	2.8	19	16.5	61	2.8	4	•	627 0730	7.3	38	38	109	7.3	6	•
627 0290	2.9		16.5	61	2.9	4	•	627 0740	7.4		38	109	7.4	6	•
627 0300	3	21	18	61	3	4	•	627 0750	7.5	41	38.5	109	7.5	6	•
627 0310	3.1		18	61	3.1	4	•	627 0760	7.6		38.5	109	7.6	6	•
627 0320	3.2	23	21.5	70	3.2	4	•	627 0770	7.7	44	41	117	7.7	6	•
627 0330	3.3		21.5	70	3.3	4	•	627 0780	7.8		41	117	7.8	6	•
627 0340	3.4	26	21.5	70	3.4	4	•	627 0790	7.9	47	41	117	7.9	6	•
627 0350	3.5		21.5	70	3.5	4	•	627 0800	8		41	117	8	6	•
627 0360	3.6	23	21.5	70	3.6	4	•	627 0810	8.1	41	41	117	8.1	6	•
627 0370	3.7		23	75	3.7	4	•	627 0820	8.2		41	117	8.2	6	•
627 0380	3.8	28	23	75	3.8	4	•	627 0830	8.3	48	41	117	8.3	6	•
627 0390	3.9		23	75	3.9	4	•	627 0840	8.4		41	117	8.4	6	•
627 0400	4	28	23	75	4	4	•	627 0850	8.5	52	41	117	8.5	6	•
627 0410	4.1		23	75	4.1	6	•	627 0860	8.6		41	117	8.6	6	•
627 0420	4.2	28	25.5	80	4.2	6	•	627 0870	8.7	56	45.5	125	8.7	6	•
627 0430	4.3		25.5	80	4.3	6	•	627 0880	8.8		45.5	125	8.8	6	•
627 0440	4.4	28	25.5	80	4.4	6	•	627 0890	8.9	61	45.5	125	8.9	6	•
627 0450	4.5		25.5	80	4.5	6	•	627 0900	9		45.5	125	9	6	•
627 0460	4.6	28	25.5	80	4.6	6	•	627 0910	9.1	68	45.5	125	9.1	6	•
627 0470	4.7		28	86	4.7	6	•	627 0920	9.2		45.5	125	9.2	6	•
627 0480	4.8	28	28	86	4.8	6	•	627 0930	9.3	70	45.5	125	9.3	6	•
627 0490	4.9		28	86	4.9	6	•	627 0940	9.4		45.5	125	9.4	6	•
627 0500	5	28	28	86	5	6	•	627 0950	9.5	76	45.5	125	9.5	6	•
627 0510	5.1		28	86	5.1	6	•	627 0960	9.6		45.5	125	9.6	6	•
627 0520	5.2	31.5	31.5	93	5.2	6	•	627 0970	9.7	80	48	133	9.7	6	•
627 0530	5.3		31.5	93	5.3	6	•	627 0980	9.8		48	133	9.8	6	•
627 0540	5.4	31.5	31.5	93	5.4	6	•	627 0990	9.9	86	48	133	9.9	6	•
627 0550	5.5		31.5	93	5.5	6	•	627 1000	10		48	133	10	6	•
627 0560	5.6	31.5	31.5	93	5.6	6	•	627 1050	10.5	92	48.5	133	10.5	6	•
627 0570	5.7		31.5	93	5.7	6	•	627 1100	11		52	142	11	6	•
627 0580	5.8	31.5	31.5	93	5.8	6	•	627 1150	11.5	100	52.5	142	11.5	6	•
627 0590	5.9		31.5	93	5.9	6	•	627 1200	12		56	151	12	6	•
627 0600	6	32	32	93	6	6	•	627 1300	13	110	57	151	13	6	•
627 0610	6.1		32	93	6.1	6	•	627 1400	14		61	160	14	6	•
627 0620	6.2	34.5	34.5	101	6.2	6	•	627 1500	15	120	65	160	15	6	•
627 0630	6.3		34.5	101	6.3	6	•	627 1600	16		68	170	16	6	•
627 0640	6.4	34.5	101	6.4	6	•									

Material Group | Material-Gruppe | Groupe Matière | Gruppo Materiali | 材质主类

Cutting Parameter

N01
N02
N03
K01
K02
P01
P02
P03
M01
M02
S01
S02
S03
H01
H02
O01
O02
507

RE 45 MACHINE REAMERS ACC. TO DIN 212, 60° L.H. HELIX, R.H. CUT, SPECIAL LEAD ENTRANCE, 3 - 4 RESPECTIVELY 6 FLUTES

- VHM RE 45 Maschinenreihbahen nach DIN 212, 60° Linksdrall, rechtsschneidend, Sonder- Anschnitt, 3 - 4 bzw. 6 Schneiden
- Alesatori a macchina RE 45, DIN 212, con elica 60° a sinistra, taglio a destra, imbocco speciale, 3-4 resp. 6 taglienti
- Alésoirs machine RE 45 selon DIN 212 en carbure, hélices 60° à gauche, coupe à droite, entrée spéciale, 3 - 4 resp. 6 dents
- 整体硬质合金 RE 45 系列 3/4/6刃大螺旋槽铰刀(带颈位) ~DIN 212



RE 45

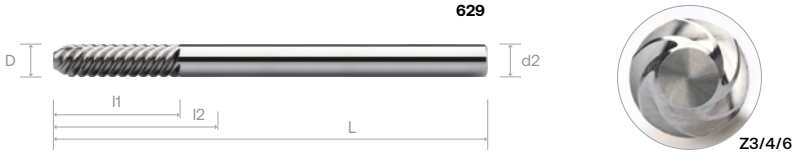

Order Number	Dimension (mm)						UC	Order Number	Dimension (mm)						UC
	D (H7)	l1	l2	L	d2 (h9)	Z			D (H7)	l1	l2	L	d2 (h9)	Z	
629 0200	2	11		49	2	3	°	629 0650	6.5	28		101	6.5	6	°
629 0210	2.1			49	2.1	3	°	629 0660	6.6			101	6.6	6	°
629 0220	2.2			57	2.2	3	°	629 0670	6.7			109	6.7	6	°
629 0230	2.3	14		57	2.3	3	°	629 0680	6.8	31		109	6.8	6	°
629 0240	2.4			57	2.4	3	°	629 0690	6.9			109	6.9	6	°
629 0250	2.5			57	2.5	3	°	629 0700	7			109	7	6	°
629 0260	2.6	15		57	2.6	3	°	629 0710	7.1	31		109	7.1	6	°
629 0270	2.7			61	2.7	3	°	629 0720	7.2			109	7.2	6	°
629 0280	2.8			61	2.8	3	°	629 0730	7.3			109	7.3	6	°
629 0290	2.9	15		61	2.9	3	°	629 0740	7.4	31		109	7.4	6	°
629 0300	3			61	3	3	°	629 0750	7.5			109	7.5	6	°
629 0310	3.1			61	3.1	3	°	629 0760	7.6			109	7.6	6	°
629 0320	3.2	18		70	3.2	3	°	629 0770	7.7	33		117	7.7	6	°
629 0330	3.3			70	3.3	3	°	629 0780	7.8			117	7.8	6	°
629 0340	3.4			70	3.4	3	°	629 0790	7.9			117	7.9	6	°
629 0350	3.5	18		70	3.5	3	°	629 0800	8	33		117	8	6	°
629 0360	3.6			70	3.6	3	°	629 0810	8.1			117	8.1	6	°
629 0370	3.7			75	3.7	3	°	629 0820	8.2			117	8.2	6	°
629 0380	3.8	19		75	3.8	3	°	629 0830	8.3	36		117	8.3	6	°
629 0390	3.9			75	3.9	3	°	629 0840	8.4			117	8.4	6	°
629 0400	4			75	4	3	°	629 0850	8.5			117	8.5	6	°
629 0410	4.1	21		75	4.1	4	°	629 0860	8.6	36		117	8.6	6	°
629 0420	4.2			80	4.2	4	°	629 0870	8.7			125	8.7	6	°
629 0430	4.3			80	4.3	4	°	629 0880	8.8			125	8.8	6	°
629 0440	4.4	21		80	4.4	4	°	629 0890	8.9	36		125	8.9	6	°
629 0450	4.5			80	4.5	4	°	629 0900	9			125	9	6	°
629 0460	4.6			80	4.6	4	°	629 0910	9.1			125	9.1	6	°
629 0470	4.7	23		86	4.7	4	°	629 0920	9.2	36		125	9.2	6	°
629 0480	4.8			86	4.8	4	°	629 0930	9.3			125	9.3	6	°
629 0490	4.9			86	4.9	4	°	629 0940	9.4			125	9.4	6	°
629 0500	5	23		86	5	4	°	629 0950	9.5	38		125	9.5	6	°
629 0510	5.1			86	5.1	4	°	629 0960	9.6			125	9.6	6	°
629 0520	5.2			93	5.2	4	°	629 0970	9.7			133	9.7	6	°
629 0530	5.3	26		93	5.3	4	°	629 0980	9.8	38		133	9.8	6	°
629 0540	5.4			93	5.4	4	°	629 0990	9.9			133	9.9	6	°
629 0550	5.5			93	5.5	4	°	629 1000	10			133	10	6	°
629 0560	5.6	26		93	5.6	4	°	629 1050	10.5	41		133	10.5	6	°
629 0570	5.7			93	5.7	4	°	629 1100	11			142	11	6	°
629 0580	5.8			93	5.8	4	°	629 1150	11.5			142	11.5	6	°
629 0590	5.9	28		93	5.9	4	°	629 1200	12	44		151	12	6	°
629 0600	6			93	6	4	°	629 1300	13			151	13	6	°
629 0610	6.1			93	6.1	6	°	629 1400	14			160	14	6	°
629 0620	6.2	28		101	6.2	6	°	629 1500	15	50		160	15	6	°
629 0630	6.3			101	6.3	6	°	629 1600	16			170	16	6	°
629 0640	6.4			101	6.4	6	°								

Material Group | Material-Gruppe | Groupe Matière | Gruppo Materiali | 材质主类

Cutting Parameter

N01
 N02
 N03
 K01
 K02
 P01
 P02
 P03
 M01
 M02
 S01
 S02
 S03
 H01
 H02
 O01
 O02

507

Recommended Cutting Data



Note: These recommended cutting data indicators are just for reference. They should be adjusted according to the different cutting condition



RE 45

RE 45 Series, 2 / 3 / 4 / 5 / 6 Flutes - 621, 623, 625, 627, 629

Reaming	Stock removal	N						K				S	
Working Material		Wrought Aluminium		Cast Aluminium		Copper alloy		Grey Cast Iron		Ductile Cast Iron		Titanium alloy	
Properties		Si < 9%		Si ≥ 9%		-		-		-		-	
D		Vc	fn	Vc	fn	Vc	fn	Vc	fn	Vc	fn	Vc	fn
1	0.105		0.017		0.017		0.019		0.025		0.023		0.015
2	0.150		0.035		0.036		0.040		0.052		0.045		0.038
3	0.150		0.055		0.056		0.064		0.076		0.070		0.056
4	0.225		0.076		0.080		0.088		0.110		0.100		0.086
5	0.225		0.100		0.104		0.115		0.135		0.120		0.100
6	0.225		0.120		0.130		0.150		0.170		0.150		0.140
8	0.280	40	0.170	35	0.180	30	0.200	20	0.230	12	0.220	8	0.175
10	0.280		0.220		0.220		0.250		0.280		0.270		0.235
12	0.315		0.270		0.280		0.310		0.320		0.290		0.267
13	0.375		0.280		0.290		0.312		0.370		0.340		0.310
14	0.375		0.280		0.320		0.330		0.375		0.360		0.320
15	0.375		0.290		0.325		0.330		0.380		0.365		0.330
16	0.375		0.320		0.350		0.370		0.430		0.366		0.340

RE 45 Series, 2 / 3 / 4 / 5 / 6 Flutes - 621, 623, 625, 627, 629

Reaming	Stock removal	P						M				S	
Working Material		Carbon steel		Alloy steel		Prehardened steel		Stainless steel		Stainless steel		Nickel alloy	
Properties		-		520 < Rm < 1200		35 ≤ HRC < 45		High machinability		Low machinability		-	
D		Vc	fn	Vc	fn	Vc	fn	Vc	fn	Vc	fn	Vc	fn
1	0.105		0.025		0.024		0.023		0.022		0.019		0.015
2	0.150		0.052		0.050		0.049		0.045		0.044		0.040
3	0.150		0.076		0.075		0.076		0.070		0.064		0.050
4	0.225		0.110		0.105		0.105		0.100		0.100		0.080
5	0.225		0.135		0.130		0.120		0.130		0.114		0.090
6	0.225		0.170		0.170		0.160		0.160		0.150		0.100
8	0.280	20	0.230	18	0.210	16	0.210	14	0.210	10	0.225	6	0.130
10	0.280		0.280		0.290		0.260		0.280		0.250		0.200
12	0.315		0.320		0.345		0.320		0.330		0.305		0.210
13	0.375		0.370		0.350		0.355		0.335		0.310		0.220
14	0.375		0.375		0.360		0.365		0.340		0.320		0.225
15	0.375		0.380		0.420		0.370		0.370		0.330		0.230
16	0.375		0.430		0.425		0.375		0.375		0.380		0.240

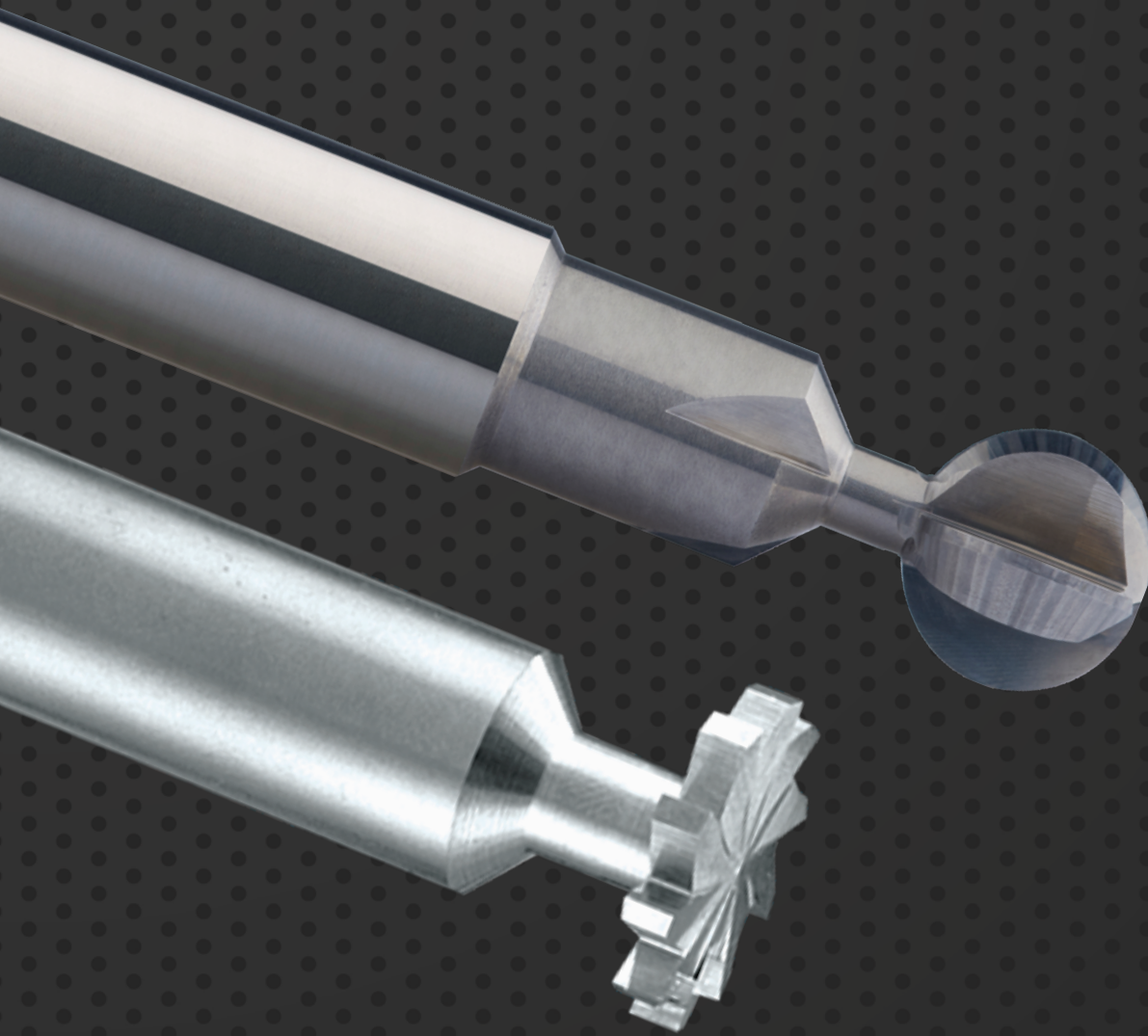

SPECIAL TOOLS

Customized Tool for Individual Requirements



Scan here to get
our specials forms.

Special Tools Request Form



- Anfrage-Formulare für Sonderwerkzeuge
- Utensili Speciali
- Fiches pour demandes d'outils spéciaux
- 非标刀具

Special Tools			
ENDMILL	BALLNOSE	SPIRAL REAMER	STEP TWIST DRILL
ENDMILL with Corner Radius	TAPER BALLNOSE	STEP REAMER	CENTER DRILL
STEP ENDMILL	TAPER ENDMILL	T-SLOT CUTTER	BURNISHING DRILL
CORNER RADIUS CUTTER	STRAIGHT FLUTE REAMER	TWIST DRILL	STEP BURNISHING DRILL

Customer's Name _____
 Person (Mr/Ms) _____
 Enquiry Number _____
 Cutting Conditions Vc: _____ Vf: _____
 Date _____ Quantity _____

Material _____
 Material to be Cut _____
 Coating _____
 Coolant Dry _____ Wet _____
 Remark _____

DEUTSCH

Sonderwerkzeuge			
Fräser	Radiusfräser	Reibahle mit Gedrallten Nuten	Stufenbohrer
Fräser mit Eckenradius	Kegeliger Radiusfräser	Stufen-Reibahle	Zentrierbohrer
Stufenfräser	Gesenkfräser	T-Fräser	4 Fasenbohrer
Viertelrund Profilfräser	Reibahle mit Geraden Nuten	Spiralbohrer	4 Fasen-Stufenbohrer

Firmenname _____ VHM _____ VHM _____
 Herr/Frau _____ Zu Zerspanendes Material _____
 Anfrage-Nr. _____ Beschichtung _____
 Arbeitsbedingungen Vc: _____ Vf: _____ Kühlung _____ Trocken _____ Nass _____
 Datum: _____ Stückzahl: _____ Bemerkung _____

FRANÇAIS

Outils Spéciaux			
Fraise	Fraise Hémisphérique	Alésoir avec Goujures Hélicoïdal	Foret Étagé
Fraises avec Rayon	Fraise Hémisphérique Conique	Alésoir Étagé	Foret à Centrer
Fraise Étagée	Fraise Conique pour Matrices	Fraise à T	Foret Carré
Fraise ¼ de Cercle	Alésoir avec Goujures Droites	Foret Hélicoïdal	Foret Carré Étagé

Nom de la Société _____ Carbure Monobloc _____ VHM _____
 Mr/Mme _____ Matière à Usiner _____
 Demande No. _____ Revêtement _____
 Conditions d'Usage Vc: _____ Vf: _____ Lubrification _____ À Sec _____ Avec Lubrification _____
 Date: _____ Quantité: _____ Remarques _____

ITALIANO

Utensili Speciali			
Fresa	Fresa Cilindrica a Raggio	Alesatore con Gole Elicoidale	Punta a Gradino
Fresa con Angolo Raggiato	Fresa Cilindrica a Raggio Conica	Alesatore a Gradino	Punta a Centrare
Fresa a Gradino	Fresa Conica	Fresa a T	Punta a 4 Fasi
Fresa ¼ Circolare	Alesatore con Gole Diritte	Punta Elicoidale	Punta a 4 Fasi a Gradino

Nome della Società _____ Metallo Duro Integrale _____ VHM _____
 Sig./Sig.ra _____ Materiale da Lavorare _____
 Richiesta No. _____ Rivestimento _____
 Condizioni di Lavoro Vc: _____ Vf: _____ Con Lubrificazione _____ A Secco _____ Con Lubrificazione _____
 Date: _____ Quantità: _____ Osservazione _____

中文

非标刀具			
端铣平刀	球头铣刀	螺旋铰刀	阶梯钻头
圆鼻端铣平刀	锥度球头铣刀	阶梯铰刀	中心钻
阶梯铣刀	锥度端铣平刀	T型刀	钻铰刀
倒圆弧铣刀	直刃铰刀	钻头	阶梯钻铰刀

用户名称 _____ 刀具材料 _____ VHM _____
 销售人员 _____ 被加工材料 _____
 图纸编号 _____ 涂层种类 _____
 切削参数 Vc: _____ Vf: _____ 冷却方式 _____ 干-油雾/吹气 _____ 湿-切削剂/切削油 _____
 日期: _____ 数量: _____ 备注 _____

ENDMILL

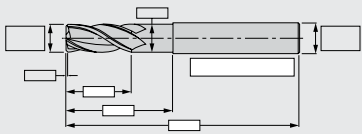

STEP ENDMILL

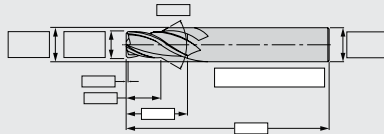

BALLNOSE

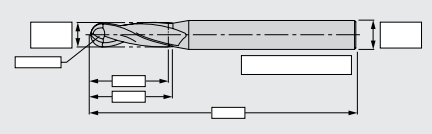

ENDMILL WITH CORNER RADIUS

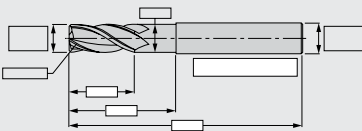

CORNER RADIUS CUTTER

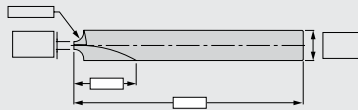

TAPER BALLNOSE

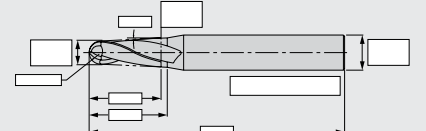

TAPER ENDMILL

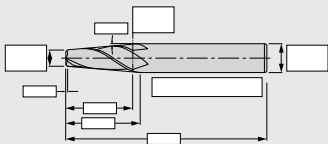

STEP REAMER

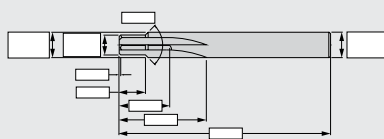

STRAIGHT FLUTE REAMER

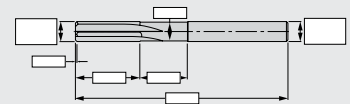

TAPER ENDMILL WITH CORNER RADIUS

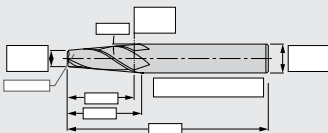

T-SLOT ENDMILL

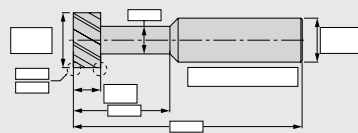

SPIRAL REAMER

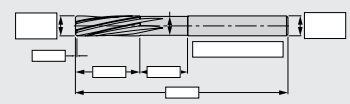

TWIST DRILL

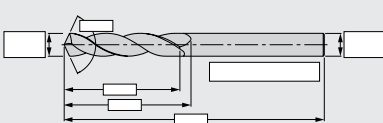

STEP TWIST DRILL

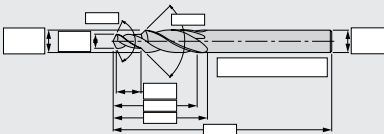

BURNISHING DRILL

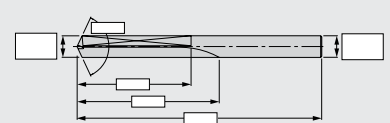

NC SPOT DRILL

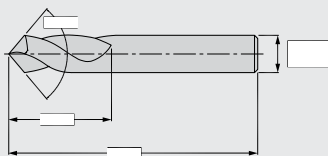

CENTER DRILL

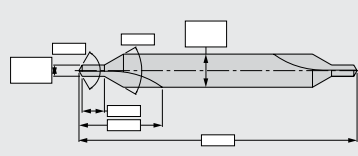

STEP BURNISHING DRILL

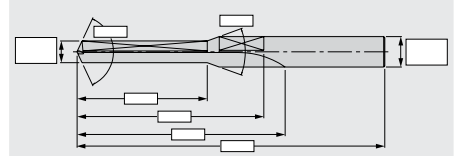

Softcopy version can get from our website.

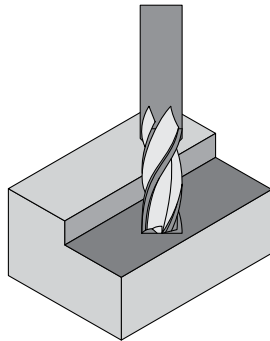

Face Milling:

A process that the front teeth of the tool are engaged to create a flat surface

Tool engagement : small **Ap** and large **Ae**

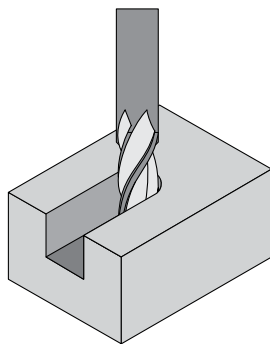

Slotting:

A process that full cutting diameter is engaged $Ae=D$ while Ap up to $1\frac{1}{2}$ times.

D depending on the machining strategy in use.

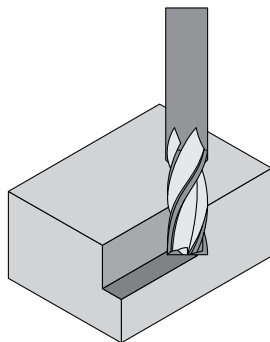

Side Milling:

A process that only the side of the tool is engaged. Ae is large while Ap is small.

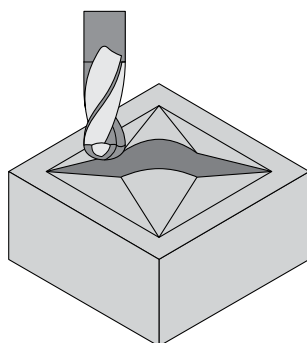

Profiling:

A process that the radius is engaged. Both Ae and Ap are small.

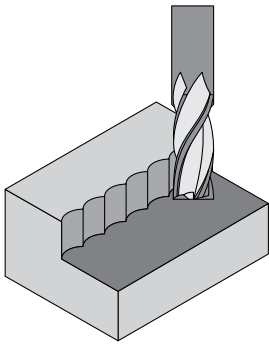
**Plunging:**

Open a deep slot with Z-axis drilling.

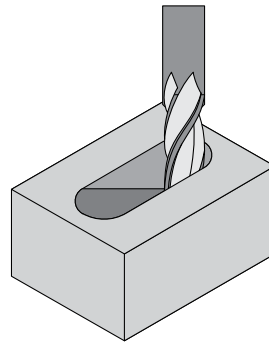
**Ramping:**

Open a pocket by making a Z-axis at an angle.

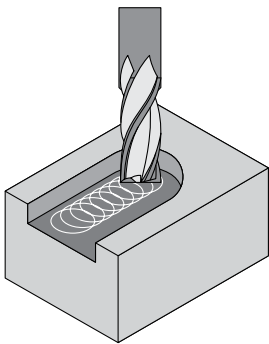
**Trochoidal Milling:**

Open a slot by making partial circular movement in either X-axis or Y-axis.
(Converting slotting to side milling)

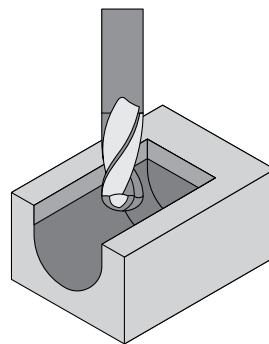
**Push-Pull:**

From 3D by making a up and down movement by following the profile of the form.

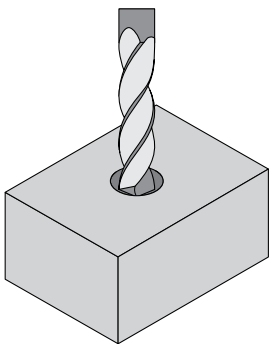
**Drilling:**

Open a hole with Z-axis movement.

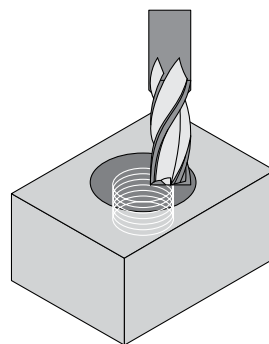
**Helical Interpolation:**

Open a pocket with circular movement while the tool ramping in Z-axis.

Deutsch



Français



Italiano



中文



Speed / rpm	Drehzahl	Vitesse de rotation	Velocità di Rotazione	转速
$n = \frac{Vc \times 1000}{D \times \pi} \text{ [min}^{-1}\text{]}$				

Cutting Speed	Schnittgeschwindigkeit	Vitesse de Coupe	Velocità di Taglio	切割速度
$Vc = \frac{n \times D \times \pi}{1000} \text{ [m/min]}$				

Feed per Tooth	Vorschub pro Zahn	Avance par Dent	Avanzamento per Dente	每齿进给量
$Fz = \frac{Vf}{Z \times n} \text{ [mm]}$				

Feed per Revolution	Vorschub pro Umdrehung	Avance par Tour	Tou Advance	提前土特产品
$f = Fz \times Z \text{ [mm]}$				

Feed Speed	Vorschubgeschwindigkeit	Vitesse d'Avance	Avanzamento	进给速度
$Vf = Fz \times Z \times n \text{ [mm/min]}$				

Feed Speed	Vorschubgeschwindigkeit	Vitesse d'Avance	Avanzamento	进给速度
$hm = Fz \times \frac{\sqrt{Ae}}{D} \text{ [mm]}$				

Effective Diameter	Effektiver Durchmesser	Diamètre Effectif	Diametro Effettivo	有效直径
$hm = 2 \times \sqrt{D \times Ap - Ap^2} \text{ [mm]}$				

Symbol key:

π = 3.1416

D = tool diameter (mm)

Z = Number of flutes

Ap = Cutting depth

Ae = Cutting width

Tab Size Table

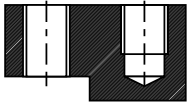

Tab size holes

Ø	M	Former M	MF	Former MF	UNC	Former UNC	UNF	Former UNF	BSW - W	DIN 5156	DIN 5156	NPT, NPTF	DIN 40432	TR
										BSP - G			DIN 40433	
0.75	1 x 0.25													
0.85	1.1 x 0.25													
0.95	1.2 x 0.25													
1.10	1.4 x 0.3													
1.20									1/16 - 60					
1.25	1.6 x 0.35						0 - 80							
1.30	1.7 x 0.35													
1.45	1.8 x 0.35	1.6 x 0.35												
1.55					1 - 64		1 - 72							
1.60	2 x 0.4													
1.75	2.2 x 0.45		2 x 0.25											
1.85					2 - 56									
1.90	2.3 x 0.4						2 - 64		3/32 - 48					
1.95			2.2 x 0.25			2 - 56								
2.05	2.5 x 0.45		2.3 x 0.25											
2.10	2.6 x 0.45				3 - 48									
2.15			2.5 x 0.35				3 - 56							
2.25			2.6 x 0.35											
2.30		2.5 x 0.45				3 - 48								
2.35					4 - 40									
2.40							4 - 48							
2.50	3 x 0.5								1/6 - 40					
2.55						4 - 40								
2.60								4 - 48						
2.65			3 x 0.35		5 - 40									
2.70							5 - 44							
2.75		3 x 0.5												
2.85					6 - 32	5 - 40								
2.90	3.5 x 0.6							5 - 44						
2.95							6 - 40							
3.10						6 - 32								
3.15			3.5 x 0.35											
3.20		3.5 x 0.6						6 - 40	5/32 - 32					
3.30	4 x 0.7													
3.50			4 x 0.5		8 - 32		8 - 36							
3.60									3/16 - 24					
3.65		4 x 0.7												
3.75				4 x 0.5										
3.80					8 - 32		8 - 36							
3.90					10 - 24									
4.10							10 - 32							
4.20	5 x 0.8													
4.30						10 - 24								
4.45								10 - 32						
4.50			5 x 0.5		12 - 24				7/32 - 24					
4.60		5 x 0.8												
4.70							12 - 28							
4.75				5 x 0.5										

Tab Size Table

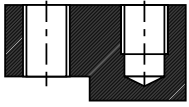

Tab size holes

Ø	M	Former M	MF	Former MF	UNC	Former UNC	UNF	Former UNF	BSW - W	DIN 5156	DIN 5156	NPT, NPTF	DIN 40432	TR
										BSP - G			PG	
5.00	6 x 1					12 - 24								
5.05								12 - 28						
5.10					1/4 - 20				1/4 - 20					
5.20			6 x 0.75											
5.50	6 x 1	6 x 0.5					1/4 - 28							
5.65				6 x 0.75										
5.75				6 x 0.5		1/4 - 20								
5.90								1/4 - 28						
6.00	7 x 1													
6.20			7 x 0.75											
6.30												1/16 - 27		
6.50		7 x 1							5/16 - 18					
6.60					5/16 - 18									
6.80	8 x 1.25									1/16 - 28				
6.90							5/16 - 24							
7.00			8 x 1											
7.20			8 x 0.75											
7.25						5/16 - 18								
7.40		8 x 1.25						5/16 - 24						
7.50			8 x 0.5	8 x 1										
7.80	9 x 1.25													
7.90									3/8 - 16					
8.00			9 x 1		3/8 - 16									
8.20											1/8 - 28			10 - 2
8.50	10 x 1.5						3/8 - 24					1/8 - 27		
8.70						3/8 - 16								
8.80			10 x 1.25							1/8 - 28				
9.00			10 x 1					3/8 - 24						
9.20			10 x 0.75											
9.25														12 - 3
9.30		10 x 1.5							7/16 - 14					
9.40				10 x 1.25	7/16 - 14									
9.50				10 x 1										
9.90							7/16 - 20							
10.00			10 x 1											
10.20	12 x 1.75													12 - 2
10.50			12 x 1.5						1/2 - 12					
10.80			12 x 1.25		1/2 - 13									
11.00			12 x 1								1/4 - 19			
11.10											1/4 - 19	1/4 - 18		
11.20		12 x 1.75	12 x 0.75											
11.25														14 - 3
11.30				12 x 1.5										
11.50				12 x 1			1/2 - 20							7 - 20
11.80						1/2" - 13				1/4 - 19				
12.00	14 x 2								9/16 - 12					
12.20					8/16 - 12									14 - 2
12.25														16 - 4

Tab Size Table

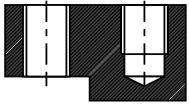

Tab size holes

Ø	M	Former M	MF	Former MF	UNC	Former UNC	UNF	Former UNF	BSW - W	DIN 5156	DIN 5156	NPT, NPTF	DIN 40432	TR
										BSP - G			PG	
12.50			14 x 1.5											
12.80			14 x 1.25											
12.90							9/16 - 18							
13.00		14 x 2	14 x 1											
13.30				14 x 1.5										
13.50			15 x 1.5						5/8 - 11					
14.00	16 x 2		15 x 1								3/8 - 19		9 - 18	
14.25				14 x 1.25										18 - 4
14.50			16 x 1.5				5/8 - 18				3/8 - 19	3/8 - 18		
15.00		16 x 2	16 x 1											
15.25									3/8 - 19					
15.30				16 x 1.5										
15.50	18 x 2.5			16 x 1										
16.00			18 x 2											
16.25														20 - 4
16.50			18 x 1.5						3/4 - 10					
17.00			18 x 1											
17.25				18 x 1.5									11 - 18	22 - 5
17.50	20 x 2.5						3/4 - 16							
17.75												1/2 - 14		
18.00			20 x 2								1/2 - 14			
18.50			20 x 1.5		3/4 - 10									
18.60														
19.00			20 x 1							1/2			13.5 - 18	
19.25				20 x 1.5					7/8 - 9					24 - 5
19.50	22 x 2.5				7/8 - 9									
20.00			22 x 2											
20.40			22 x 1.5				7/8 - 14							
21.00	24 x 3		22 x 1							5/8 - 14				

Drilling on Standard Through Hole

* For references only.

1

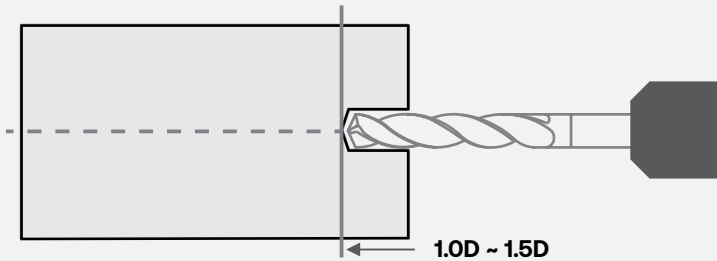

Develop pilot bore

- Using a 3xD pilot drill (DR45/DR-S) with point angle 140° and tolerance m7 (4 - 25 micron > Ø deep hole drill)
- Drilling pilot bore depth with minimum of 1 to 1.5D

2

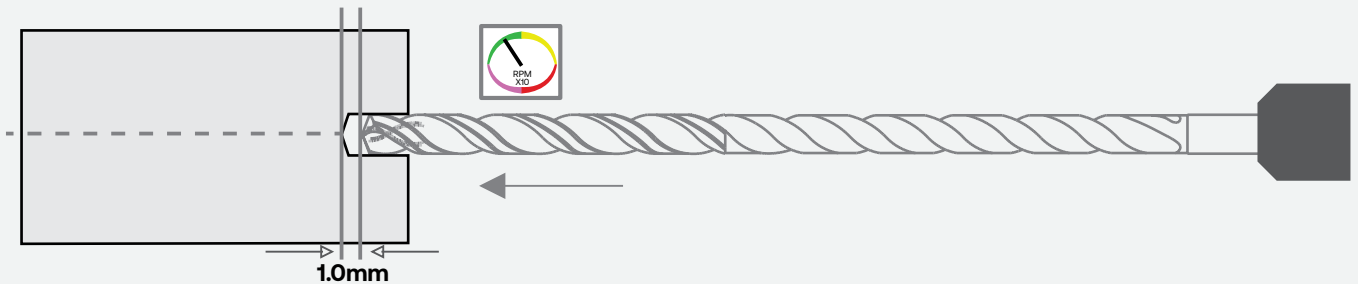

Enter according to pilot bore

- Enter without coolant be upon 1mm before the end of pilot bore
- Approximate 300 rpm and feedrate of 500 mm/min
- Then start high pressure coolant

3

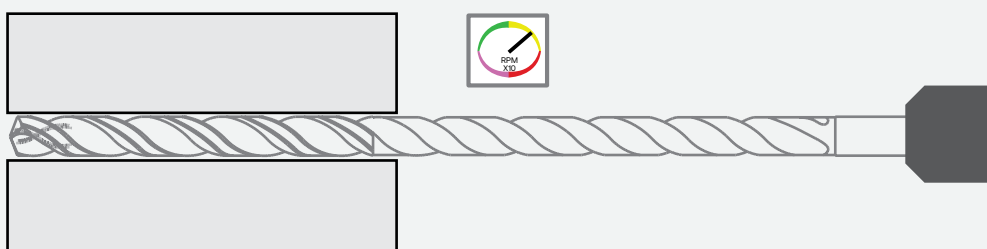

Deep drilling process

- Load higher spindle speed (Vc) and feedrate (f) as per recommended
- Continuous drilling upon complete hole depth without chip removal cycles/peck drilling cycles
- For through holes, reduce 30% of feedrate approximate 1mm before complete the hole depth

Drilling on Standard Through Hole

* For references only.

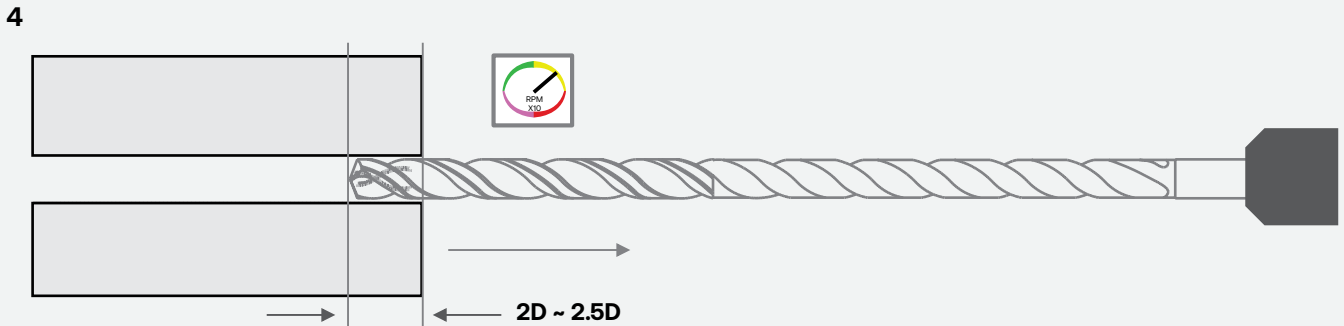

Withdrawal

- Switch off coolant supply
- Withdraw the long drills after completed drilling the hole depth
- Existing spindle speed (V_c) and double up the feedrate (f)
- Withdraw towards approximate 2 to 2.5D of the beginning part of pilot bore

5

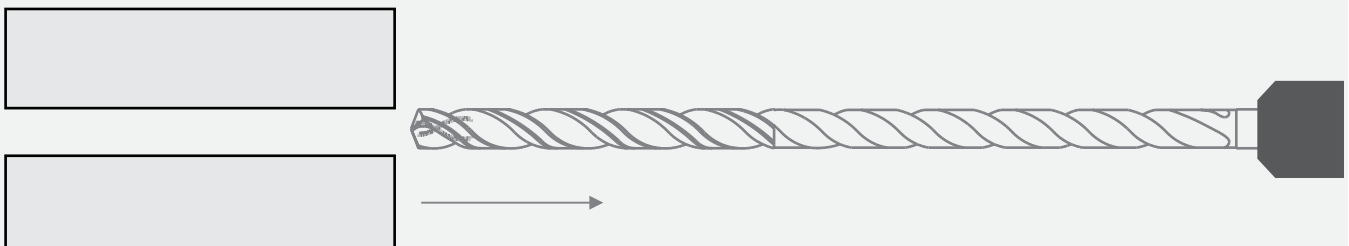

Discharge from the bore

- Discharge with lower and stationary speed from the remaining part

Drilling on Standard Through Hole

* For references only.

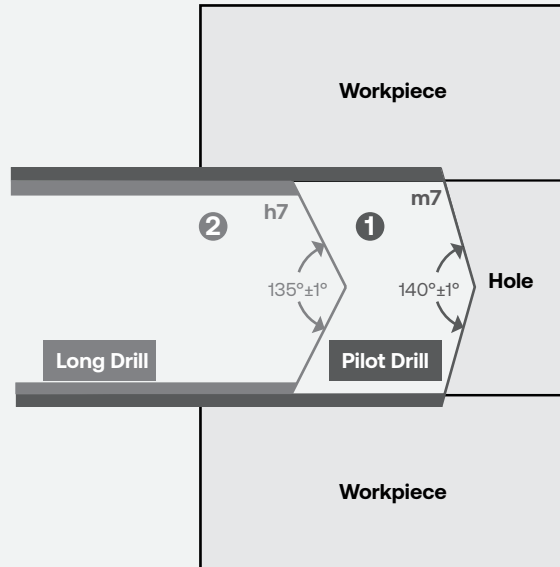

1

Pilot Bore

f6eb16

Please use the corresponding drill with internal coolant supply and the same nominal diameter for the pilot bore.
Pilot Drill Series I **DR S (140° I D(m7))**

Tolerance consideration for m7 in μm

Diameter	Tolerance, μm
$\leq \varnothing 3$	+2 ~ +12
$\varnothing 4 - \varnothing 6$	+4 ~ +16
$\varnothing 7 - \varnothing 10$	+6 ~ +21

2

Deep Hole Bore (12xD - 30xD)

Please use the corresponding drill with internal coolant supply and the same nominal diameter for the deep hole bore.
Long Drill Series I **DR-L (135° I D(h7))**

Tolerance consideration for h7 in μm

Diameter	Tolerance, μm
$\leq \varnothing 3$	0 ~ -10
$\varnothing 4 - \varnothing 6$	0 ~ -12
$\varnothing 7 - \varnothing 10$	0 ~ -15

Drilling On Irregular Faces or Angles

1



Spot Facing

- Make a flat surface by using an endmill (HPMT 918) with light slotting on the irregular faces/angles
- Machining the width and depth of spot face same size as the required deep hole diameter
- Endmill used required the capability of spot facing (ramping/plunging)

2

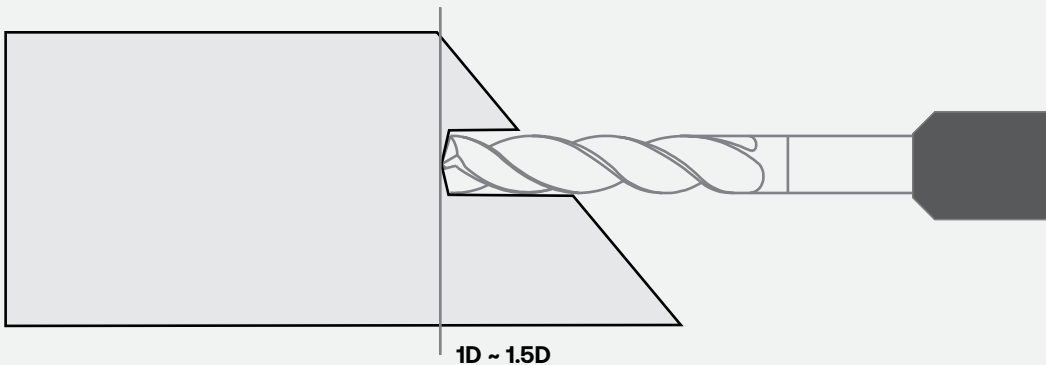

Develop pilot bore

- Using a 3xD pilot drill (DR-S) with point angle 140° & tolerance m7 (4 - 25 micron > Ø deep hole drill)
- Drilling pilot bore depth with minimum of 1 to 1.5D

3

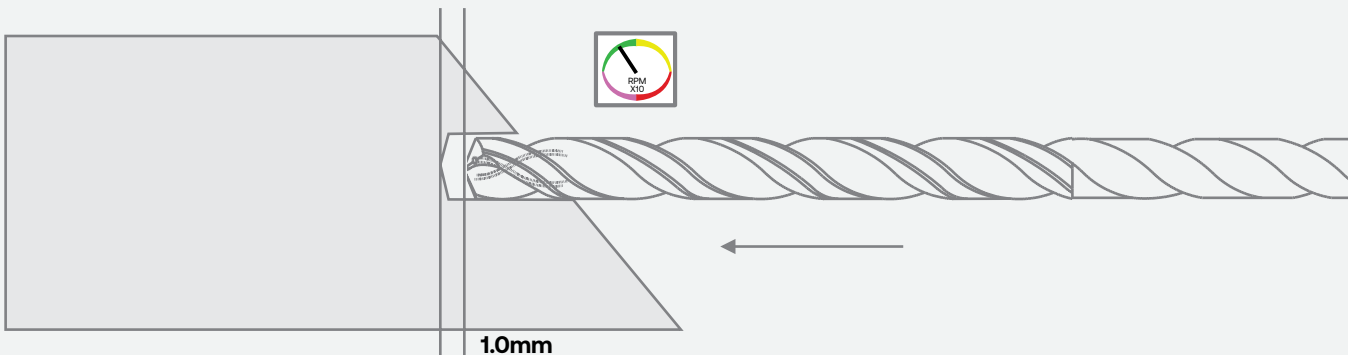

Enter according to pilot bore

- Enter without coolant be upon 1mm before the end of pilot bore
- Approximate 300 rpm and feedrate of 500 mm/min
- Then start high pressure coolant

Drilling On Irregular Faces or Angles

4

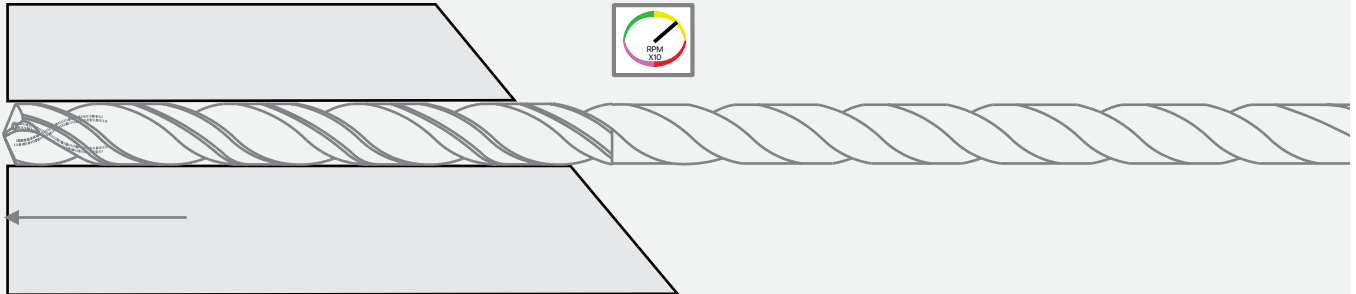

Deep drilling process

- Load higher spindle speed (V_c) and feedrate (f) as per recommended
- Continuous drilling upon complete hole depth without chip removal cycles/peck drilling cycles
- For through holes, reduce 30% of feedrate approximate 1mm before complete the hole depth

5

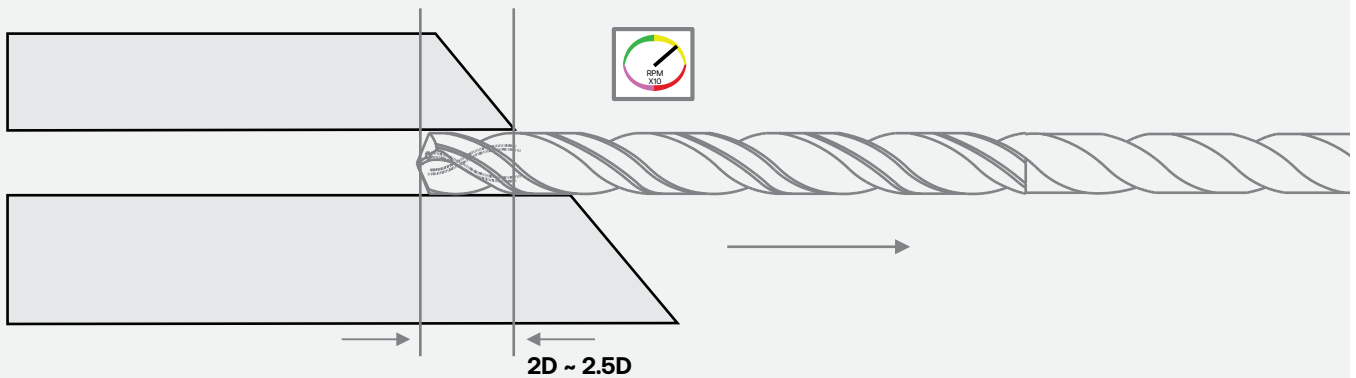

Withdrawal

- Switch off coolant supply
- Withdraw the long drills after completed drilling the hole depth
- Existing spindle speed (V_c) and double up the feedrate (f)
- Withdraw towards approximate 2 to 2.5D of the beginning part of pilot bore

6

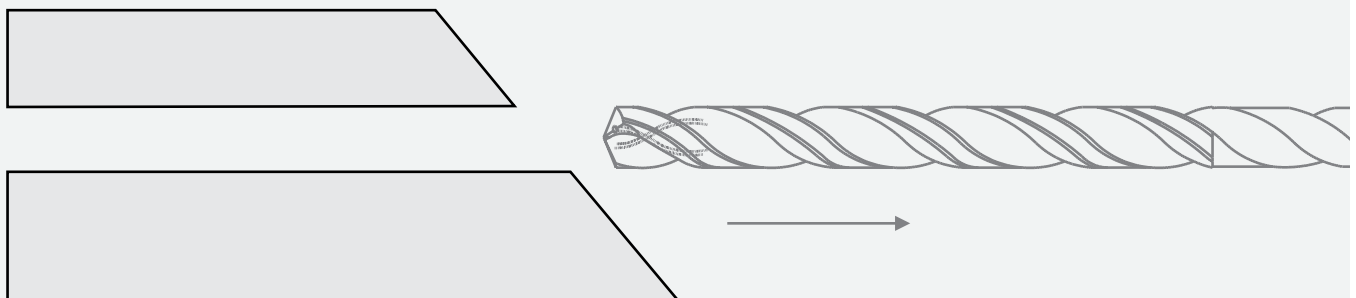

Discharge from the bore

- Discharge with lower and stationary speed from the remaining part

- Tools may shatter if broken. The wearing of eye protection is strongly advised in the vicinity of the working area.
- The correct using condition and handling of the tools is essential to secure maximum useful life and hazard free operation.
- Cutting tools have sharp edges and care must be taken, when handling, to avoid cuts/lacerations to unprotected hands.
- The wearing of gloves is not recommended, as gloves may entangle with the rotating tools.
- Tools may hurt the user's feet when falling off. Safety shoes should be put on at all time.



SICHERHEITSHINWEISE

- Werkzeuge können splintern wenn sie zerbrechen. Schutzbrillen sollten im Arbeitsumfeld getragen werden.
- Die richtige Werkzeuganwendung ist unbedingt erforderlich, um die beste Nutzung und problemfreie Einsätze zu gewährleisten.
- Zerspanungswerkzeuge haben scharfe Kanten, deshalb muss Sorgfalt angewendet werden um Schnitte/Abschürfungen an den ungeschützten Händen zu vermeiden.
- Das Tragen von Handschuhen ist nicht zu empfehlen, da Handschuhe sich mit den rotierenden Werkzeugen verwickeln können.
- Die Füße des Benutzers können verletzt werden, wenn die Werkzeuge herunterfallen. Deshalb sollten Sicherheitsschuhe immer getragen werden.



AVIS DE SÉCURITÉ

- Tout outil peut s'effriter lorsqu'il se casse. L'utilisation de lunettes protectrices dans l'aire de travail est recommandée.
- L'emploi et l'utilisation correcte de l'outil de coupe est essentiel afin de garantir une longue utilisation sans problèmes.
- Les outils coupants ont des arrêtes aiguës et des précautions sont à prendre afin d'éviter des coupures/lacérations aux mains non protégées.
- L'emploi de gants n'est pas recommandé du fait que les gants peuvent s'enchevêtrer avec les outils en rotation.
- Les outils peuvent blesser les pieds de l'utilisateur lorsqu'ils tombent. Des souliers de protection doivent être portés à tout moment.



AVVISO DI SICUREZZA

- Utensili possono scheggiarsi quando si rompono. Pertanto è consigliato di portare degli occhiali di protezione nell'area di lavoro.
- L'impiego e la manutenzione corretta dell'utensile è essenziale per assicurarne la longevità e lavorare senza problemi.
- Utensili da taglio hanno taglienti vivi e bisogna prendere delle cautele al fine di evitare dei tagli/lacerazioni sulle mani non protette.
- Non si raccomanda di portare dei guanti dato che questi possono attorcigliarsi con gli utensili in rotazione.
- Quando utensili cadono, possono ferire i piedi dell'utente. Pertanto le scarpe di protezione sono da portarsi ad ogni momento.



警告 - 安全规范

- 刀具破损时会碎裂，在操作场所内请务必戴上眼睛保护措施。
- 正确保管及使用刀具，除了可以确保操作安全无虑、而且增加刀具使用寿命。
- 切削刀具的刃口锋利，操作使用时请务必小心，以避免对无保护双手割伤或破损。
- 不建议戴上手套，因为手套可能会被旋转机器卷入。
- 刀具掉落时会伤及使用者的双脚，全程应穿上安全鞋。

THIS CATALOGUE EDITION SUPERSEDES ALL PREVIOUS CATALOGUE.

- Eventual printing errors or meanwhile occurred changes do not justify claims.
- **Technical Specifications Subject to Change without Prior Notice.**
- All pictures and sketches are not binding.
- Reprinting of the catalogue or parts of it is not permitted. Exceptions need our expressly stated permission in writing.
- **General Sales Conditions** – see our pricelist.



MIT DEM ERSCHEINEN DIESES KATALOGES, VERLIEREN DIE VORHERIGEN KATALOGE IHRE GÜLTIGKEIT.

- Eventuelle Druck- oder Satzfehler oder zwischenzeitlich eingetretene Änderungen berechtigen nicht zu Ansprüchen.
- **Technische Änderungen ohne vorheriger Information vorbehalten.**
- Bildliche Darstellungen sind nicht verbindlich.
- Nachdruck des Katalogs, auch auszugsweise, ist nicht gestattet. Ausnahmen bedürfen unserer schriftlichen Genehmigung.
- **Allgemeine Geschäftsbedingungen**
– siehe unsere Preisliste



AVEC LA PARUTION DE CE CATALOGUE, TOUS LES CATALOGUES PRÉCÉDENTS PERDENT LEUR VALIDITÉ.

- Éventuelles erreurs d'impression ou des modifications intervenues dans l'entretemps ne justifient pas le droit à plaintes.
- **Spécifications techniques sujettes à changement sans avis préalable.**
- Les photos ou esquisses sont sans obligations/engagements.
- Les reproductions de textes et de photos, même partiellement, ne pas autorisées sans notre accord préalable par écrit.
- **Conditions générales de vente et de livraison**
– voir notre tarif



CON LA STAMPA DI QUESTO CATALOGO, TUTTI I CATALOGHI PRECEDENTI PERDONO LA LORO VALIDITÀ.



















- Eventuali errori di stampa o cambiamenti occorsi nel frattempo non danno diritto a reclami.
- **Modifiche tecniche possibili senza preavviso.**
- Tutte le fotografie e bozze non sono impegnative.
- Non è permessa la riproduzione di testi o figure, anche parzialmente, senza la nostra autorizzazione scritta.
- **Condizioni generali di vendita** – vedi nostro listino



此新目录将取代旧目录。

- 可能会有印刷错误或变更, 不可作为求偿要件。
- **若有技术规格变更, 恕不事先通知。**
- 图片及示意图仅供参考。
- 除得到本公司明确的书面许可, 禁止再版本目录的部分或全部。
- 一般销售条件 - 请参阅价目表。

Description Of The Icons (Eng)

1 Tool Material (Tungsten Carbide)					
	Micro Grain Carbide 90% WC 6% CO 91.5 HRA 0.7 micron Grain Size ISO Grade K10/K30		Micro Grain Carbide 90% WC 10% CO 92.0±0.5 HRA 0.8 micron Grain Size ISO Grade K10/K30		Micro Grain Carbide 93.5% WC 6% CO 93.5 HRA 0.6 micron Grain Size ISO Grade K05/K10
	Ultra Fine Carbide 86.5% WC 12% CO 93.0±0.5 HRA 0.5 micron Grain Size ISO Grade K10/K40		Ultra Fine Carbide 91% WC 9% CO 93.9 HRA 0.2 micron Grain Size ISO Grade K05/K10		
2 Corner Form					
	Sharp corner Edge		Corner Edge Radius Tolerance Of The Radius		Full Radius Tolerance Of The Radius
	Chamfer				
3 Cutting Geometry					
	Display Helix Angle Of Flute		Taper Angle		No Vibration
	No Vibration				
4 Shank design		5 Thread-Mill			
	HA = Plain shank HB = Weldon Shank		Without Oil Hole		Internal Oil Hole
6 DR					
	Without Oil Hole		Internal Oil Hole		Drilling Depth

Description Of The Icons (Eng)

7 Coatings							
Type of Coating	Coating Material	Hardness	Oxidation Resistance Temperature	Coefficient of Friction	Standard Thickness	Application Area	Coating Colour
	Uncoated	-/-	-/-	-/-	-/-	-/-	-/-
	AITIN (Monolayer)	(HV 0.05) 3,300	$\geq 900^{\circ}\text{C}$ $\leq 1,000^{\circ}\text{C}$	0.3	3 μm	Suitable for medium and high speed, wet and dry machining and good for machining steel with hardness up to HRC 52.	 Blue-Black
	TiSi Based (Multilayer)	(HV 0.05) 3,600	$\leq 1,200^{\circ}\text{C}$	0.3	2.5 - 3.5 μm	Suitable for high speed (dry) and hard machining for difficult materials above HRC 52. Suitable for high speed machining with hardened steels above HRC 60	 Copper
	AlTiSiN Based (Multilayer)	3,800	$>1,100^{\circ}\text{C}$	0.5	2.5 - 3.5 μm	Suitable for high speed (dry) and hard machining for difficult material above HRC 50. Suitable for high speed machining with hardened steels above HRC60. Vc & Vf = +30%	 Copper to Brown
	AlCrN (Monolayer)	(HV 0.05) 3,200	$\leq 1,100^{\circ}\text{C}$	0.35	2.5 - 3.5 μm	Suitable for low to medium speed, wet and dry machining and good for machining steel with hardness and high temperature alloy up to HRC 52.	 Blue-Grey
	Diamond (Monolayer)	(GPA) 40 -90	$\leq 600^{\circ}\text{C}$	0.15 - 0.2	1.2 μm	Suitable for machining graphite and composite reinforced plastic fiber glass (CRP) (e.g. graphite electrodes, crucibles, boats)	 Dark Grey
	Alu	2,600	600°C	0.35	1 - 3 μm	Suitable for aluminium.	 Barley
	TiSi Based (Multilayer)	(HV 0.05) 3,600	$\leq 1,200^{\circ}\text{C}$	0.3	2 - 3 μm	Suitable for high performance drilling in difficult machining material.	 Copper
	TiAlN (Multilayer)	(HV 0.05) 3,300	$\leq 900^{\circ}\text{C}$	0.3-0.35	3 μm	Suitable for low and medium cutting speed under wet machining.	 Blue-Black

*HSC = High Speed Cutting
*HPT = High Performance Tools

8 Tolerances							
Ø mm	Tol. µm						
	HPMT	h5	h6	h7	h9	m7	H7
≤ 3.0	0 / -20	0 / -4	0 / -6	0 / -6	0 / -25	6	+10 / 0
3.0~6.0	0 / -25	0 / -5	0 / -8	0 / -12	0 / -30	4	+12 / 0
6.0~10.0	0 / -30	0 / -6	0 / -9	0 / -15	0 / -36	3.5	+15 / 0
10.0~18.0		0 / -8	0 / -11	0 / -18	0 / -43	3.57	+18 / 0
18.0~30.0		0 / -9	0 / -13	0 / -21	0 / -52	3.63	+21 / 0

9 Recess											
Ø (mm)	3	4	5	6	8	10	12	14	16	18	20
Recess Ø (mm)	2.8	3.7	4.6	5.5	7.4	9.2	11	13	15	17	19

Description Of The Icons (Others)

	Beschreibung der Symbole 	图标说明 (刀具规格) 	Descriptions des symboles 	Descrizione dei simboli
1	Werkstoffe (Vollhartmetall)	刀具材质 (钨钢)	Matières de coupe (carbures monobloc)	Materiali da taglio (metallo duro integrale)
	Feinkorn 90% WC 6% CO 91.5±0.5 HRA Kerngröße: 0.7 µm ISO Qualität: K10/K30	超微粒钨钢 90% 钨钢 6% 钴 硬度91.5±0.5 晶粒度0.7 micron ISO 规格 K10/K30	Micrograin 90% WC 6% CO 91.5±0.5 HRA Grain: 0.7 micron Qualité ISO: K10 / K30	Micrograno 90% WC 6% CO 91.5±0.5 HRA Grano: 0.7 micron Qualità ISO: K10 / K30
	Feinkorn 90% WC 10% CO 92.0±0.5 HRA Kerngröße: 0.8 µm ISO Qualität: K10/K30	超微粒钨钢 90% 钨钢 10% 钴 硬度92.0±0.5 晶粒度 0.8 micron ISO规格 K10 / K30	Micrograin 90% WC 10% CO 92.0±0.5 HRA Grain: 0.8 micron Qualité ISO: K10 / K30	Micrograno 90% WC 10% CO 92.0±0.5 HRA Grano: 0.8 micron Qualità ISO: K10 / K30
	Feinkorn 93.5% WC 6% CO 93.5 HRA Kerngröße: 0.6 µm ISO Qualität: K05/K10	超微粒钨钢 93.5% 钨钢 6% 钴 硬度93.5 晶粒度 0.6 micron ISO规格 K05 / K10	Micrograin 93.5% WC 6% CO 93.5 HRA Grain: 0.6 micron Qualité ISO: K05 / K10	Micrograno 93.5% WC 6% CO 93.5 HRA Grano: 0.6 micron Qualità ISO: K05 / K10
	Feinkorn 86.5% WC 12% CO 93.0±0.5 HRA Kerngröße: 0.5 µm ISO Qualität: K10/K40	超细微粒钨钢 86.5% 钨钢 12% 钴 硬度93.0±0.5 晶粒度 0.5 micron ISO规格 K10 / K40	Submicrograin 86.5% WC 12% CO 93.0±0.5 HRA Grain: 0.5 micron Qualité ISO: K10 / K40	Sub-micrograno 86.5% WC 12% CO 93.0±0.5 HRA Grano: 0.5 micron Qualità ISO: K10 / K40
	Feinkorn 91% WC 9% CO 93.9 HRA Kerngröße: 0.2 µm ISO Qualität: K05/K10	超细微粒钨钢 91% 钨钢 9% 钴 硬度93.9 晶粒度 0.2 micron ISO规格 K05 / K10	Submicrograin 91% WC 9% CO 93.9 HRA Grain: 0.2 micron Qualité ISO: K05 / K10	Sub-micrograno 91% WC 9% CO 93.9 HRA Grano: 0.2 micron Qualità ISO: K10 / K30
2	Eckenformen	刃鼻形式	Formes des angles	Forme degli angoli
	Scharfe Schneidecken	直角	Angles vifs	Angolo acuto/vivo
	Eckenradius - Torusfräser Radius - Toleranz	圆弧鼻角 圆弧公差	Angles à rayon - toriques tolérance des rayons	Angolo a raggio - toroidale tolleranza del raggio
	Radius - Fräser Radius - Toleranz	球头 圆弧公差	Bout hémisphérique tolérance des rayons	a raggio tolleranza del raggio
	Chamfer	倒角	Chamfer	Chamfer
3	Schneidengeometrien	刃口几何设计	Géometries de coupe	Geometrie da taglio
	Größe des Drallwinkels	螺旋角	Indique la valeur de l'angle d'hélice	Indica il valore dell'angolo dell'elica
	Verjüngungswinkel	锥度	angle du cône	angolo di conicità
	Keine Vibrationen	无振动	Pas de vibrations	senza vibrazioni
	Keine Vibrationen	无振动	Pas de vibrations	senza vibrazioni

Description Of The Icons (Others)

	Beschreibung der Symbole 	图标说明 (刀具规格) 	Descriptions des symboles 	Descrizione dei simboli
4	Schaftarten	刀柄形式	Types de queues	Tipi di codolo
	HA = Zylinderschaft HB = Zylinderschaft mit Weldon Fläche	HA = 平刀柄 HB = 平侧楔刀柄	HA = queue cylindrique HB = queue cylindrique et méplat Weldon	HA = codolo cilindrico HB = codolo cilindrico con piano Weldon
5	Thread-Mill	螺纹铣刀	Thread-Mill	Thread-Mill
	ohne Ölbohrung	无油孔	sans trou d'huile	senza foro di olio
	interne Ölbohrung	内部油孔	trou d'huile interne	olio di foro interno
6	DR	钻头	DR	DR
	ohne Ölbohrung	无油孔	sans trou d'huile	senza foro di olio
	interne Ölbohrung	内部油孔	trou d'huile interne	olio di foro interno
	Bohrung Tiefe	钻孔深度	la profondeur de forage	perforazione profondità

Description Of The Icons (Others)

	Beschreibung der Symbole 	图标说明 (刀具规格) 	Descriptions des symboles 	Descrizione dei simboli
7	Oberflächen-Beschichtungen	表面涂层	Revêtements des surfaces	Tipi dirivestimenti
	Unbeschichtet	硬质合金	sans revêtement	senza rivestimento
	Schichtmaterial: AlTiN (einschichtig) Mikrohärte (HV 0,05): 3,300 Max. Anwendungstemperatur: ≥ 900°C ≤ 1000°C Reibungskoeffizient 0,3 Schichtdicke : 3 µm	涂层材料 = 氮化铝钛 (单层膜) 微硬度 (HV 0.05) : 3,300 最高工作温度: ≥ 900°C ≤ 1000°C 摩擦系数: 0.3 厚度: 3微米	Revêtement = AlTiN (Monocouche) Dureté (HV 0,05): 3,300 Température max. d'utilisation: ≥ 900°C ≤ 1000°C Coefficient de friction: 0,25 Épaisseur du revêtement: 3 microns	Rivestimento AlTiN = (monostrato) Microdurezza (HV 0,05): 3,300 Temperatura massima di lavoro: ≥ 900°C ≤ 1000°C Coefficiente di frizione: 0,25 Spessore del rivestimento: 3 microns
	Schichtmaterial:TiSi basierend (mehrlagig) Mikrohärte (HV 0,05): 3,600 Max. Anwendungstemperatur: ≥ 1200°C Reibungskoeffizient 0,3 Schichtdicke : 2.5 ~ 3.5 µm	涂层材料 = 钛矽基层(多层次涂层) 微硬度 (HV 0.05) : 3,600 最高工作温度: ≥ 1200°C 摩擦系数: 0.3 厚度: 2.5 ~ 3.5微米	Revêtement = à base de TiSi (multi couches) Dureté (HV 0,05): 3,600 Température max. d'utilisation: ≥ 1200°C Coefficient de friction: 0,3 Épaisseur du revêtement: 2.5 ~ 3.5 microns	Rivestimento = a base di TiSi (multi strato) Microdurezza (HV 0,05): 3,600 Temperatura massima di lavoro: ≥ 1200°C Coefficiente di frizione: 0,3 Spessore del rivestimento: 2.5 ~ 3.5 microns
	Schichtmaterial:AlTiSiN basierend (mehrlagig) Mikrohärte (HV 0,05): 3,800 Max. Anwendungstemperatur: '>1,100 °C Reibungskoeffizient 0,5 Schichtdicke :2.5 - 3.5µm	涂层材料 = 钛矽基层(多层次涂层) 微硬度 (HV 0.05) : 3,800 最高工作温度: ' >1,100 °C 摩擦系数: 0.5 厚度: 2.5 ~ 3.5微米	Revêtement = à base de AlTiSiN (multi couches) Dureté (HV 0,05): 3,800 Température max. d'utilisation: '>1,100 °C Coefficient de friction: 0,5 Épaisseur du revêtement: 2.5 ~ 3.5 microns	Rivestimento = a base di AlTiSiN (multi strato) Microdurezza (HV 0,05): 3,800 Temperatura massima di lavoro: '>1,100 °C Coefficiente di frizione: 0,5 Spessore del rivestimento: 2.5 ~ 3.5 microns
	Schichtmaterial:AlCrN (einschichtig) Mikrohärte (HV 0,05): 3,200 Max. Anwendungstemperatur: ≤ 1100°C Reibungskoeffizient 0,35 Schichtdicke : 2.5 ~ 3.5 µm	涂层材料 = 氮化铬铝 (单层膜) 微硬度 (HV 0.05) : 3,200 最高工作温度: ≤ 1100°C 摩擦系数: 0.35 厚度: 2.5 ~ 3.5微米	Revêtement = AlCrN (monocouche) Dureté (HV 0,05): 3,200 Température max. d'utilisation: ≤ 1100°C Coefficient de friction: 0,35 Épaisseur du revêtement: 2.5 ~ 3.5 microns	Rivestimento = AlCrN (monostrato) Microdurezza (HV 0,05): 3,200 Temperatura massima di lavoro: ≤ 1100°C Coefficiente di frizione: 0,35 Spessore del rivestimento: 2.5 ~ 3.5 microns
	Schichtmaterial: Diamanten (einschichtig) Härte (GPA): 40 - 90 Max. Anwendungstemperatur: 600°C Reibungskoeffizient 0,15 - 0,20 Schichtdicke : 4 - 6 µm	涂层材 = 钻石 (单层膜) 微硬度 (GPA) : 40 - 90 最高工作温度 (°C) ≤ 600 摩擦系数 = 0.15 - 0.20 厚度: 4 ~ 6 微米	Revêtement = diamanté (monocouche) Dureté (GPA) : 40 - 90 Température max. d'utilisation: (°C) ≤ 600 Coefficient de friction = 0,15 - 0,20 Épaisseur: 4 - 6 microns	Rivestimento = diamanti (monostrato) Durezza (GPA) : 40 - 90 Temperatura massima di lavoro: (°C) ≤ 600 Coefficiente di frizione = 0,15 - 0,20 Spessore rivestimento: 4 ~ 6 micron
	Schichtmaterial: Alu Härte (GPA): 2,600 Max. Anwendungstemperatur: 600°C Reibungskoeffizient 0,35 Schichtdicke : 1 - 3 µm	涂层材料 = Alu 微硬度(GPA): 2,600 最高工作温度: 600°C 摩擦系数: 0.35 厚度: 1-3微米	Revêtement = Alu Dureté (GPA): 2,600 Température max. d'utilisation: 600°C Coefficient de friction: 0,35 Épaisseur du revêtement: 1-3 microns	Rivestimento Alu Microdurezza(GPA): 2,600 Temperatura massima di lavoro: 600°C Coefficiente di frizione: 0,35 Spessore del rivestimento: 1-3 microns
	Schichtmaterial: TiSi basierend (mehrlagig) Mikrohärte (HV 0,05): 3,600 Max. Anwendungstemperatur: 1200°C Reibungskoeffizient 0,3 Schichtdicke : 2-3 µm	涂层材料 = 钛矽基层(多层次涂层) 微硬度 (HV 0.05) : 3,600 最高工作温度: ≥ 1200°C 摩擦系数: 0.3 厚度: 2 ~ 3 微米	Revêtement = à base de TiSi (multi couches) Dureté (HV 0,05): 3,600 Température max. d'utilisation: ≥ 1200°C Coefficient de friction: 0,3 Épaisseur du revêtement: 2 ~ 3 microns	Rivestimento = a base di TiSi (multi strato) Microdurezza (HV 0,05): 3,600 Temperatura massima di lavoro: ≥ 1200°C Coefficiente di frizione: 0,25 Spessore del rivestimento: 2 ~ 3 microns
	Schichtmaterial: AlTiN (einschichtig) Mikrohärte (HV 0,05): 3,300 Max. Anwendungstemperatur: ≥ 900°C Reibungskoeffizient 0,3-0,35 Schichtdicke : 3 µm	涂层材料 = 氮化铝钛 (单层膜) 微硬度 (HV 0.05) : 3,300 最高工作温度: ≥ 900°C 摩擦系数: 0.3-0.35 厚度: 3微米	Revêtement = AlTiN (Monocouche) Dureté (HV 0,05): 3,300 Température max. d'utilisation: ≥ 900°C Coefficient de friction: 0,3-0,35 Épaisseur du revêtement: 3 microns	Rivestimento AlTiN = (monostrato) Microdurezza (HV 0,05): 3,300 Temperatura massima di lavoro: ≥ 900°C Coefficiente di frizione: 0,3-0,35 Spessore del rivestimento: 3 microns
*HSC	für Hochgeschwindigtsfräsen geeignet	高速切削	pour UGV	fresatura ad alta velocità
*HPT	Hochleistungswerkzeug	高性能刀具	outil à haute performance	utensile di alto rendimento

Description Of The Icons (Others)

8	Tolerances	公差	Tolérances			Tolleranze	
Ø mm	Tol. µm						
	HPMT	h5	h6	h7	h9	m7	H7
≤ 3.0	0 / -20	0 / -4	0 / -6	0 / -6	0 / -25	6	+10 / 0
3.0~6.0	0 / -25	0 / -5	0 / -8	0 / -12	0 / -30	4	+12 / 0
6.0~10.0	0 / -30	0 / -6	0 / -9	0 / -15	0 / -36	3.5	+15 / 0
10.0~18.0		0 / -8	0 / -11	0 / -18	0 / -43	3.57	+18 / 0
18.0~30.0		0 / -9	0 / -13	0 / -21	0 / -52	3.63	+21 / 0

9	Freistellung			带经位		riduzione gambo			dégagement		
Ø (mm)	3	4	5	6	8	10	12	14	16	18	20
Recess Ø (mm)	2.8	3.7	4.6	5.5	7.4	9.2	11	13	15	17	19

Material	HPMT	Description	Properties	W. Nr.	DIN	UNI	AFNOR	AISI/SAE/ASTM	JIS	Common Name
Aluminium wrought alloy, Si < 9%	N1	Aluminium alloys	Si < 9%	3.0255	Al99.5		A-5/1050A		(A1050)	
				3.0515	AlMn1					
				3.0517	AlMn1Cu		A-M1/3003		A3003	
				3.1255	AlCuSiMn		A-U4SG/2014			
				3.1655	AlCuBiPb		A-U5PbBi/2011		A2011	
				3.2161	G-AISI8Cu3			A380		
				3.2341	G-AISI5Mg	3599	A-S7G	B26	AC 4C	
				3.3206	AlMgSi0.5		A-GS/6060			
				3.3210	AlMgSi0.7		A-GSUC/6061		(A6063)	
				3.3315	AlMg1		A-G0.6			
				3.4335	AlZn4.5Mg1		A-Z5G/7020			
				3.4365	AlZnMgCu1.5		A-Z5GU/7075		A7075	
				3.5103	G-MgSe3Zn2Zr1		ZRE1	AMS 4442		
				3.5612	G-MgAl6Zn		G-A6-Z1	AZ61A		
3.5812	G-MgAl8Zn		(G-A7-Z1)	AZ80A						
Aluminium cast alloy, Si ≥ 9%	N2	Aluminium alloys	9% < Si < 16%	3.2315	AlMgSi1		A-SGM0.7/6082			
				3.2381	G-AISI10Mg		A-S10G	B85		
		Aluminium alloys	Si > 16%	3.2382	GD-AISI12			A413.2		
								B390.0	ADC14	
Copper alloy	N3	Copper alloys		2.0940.01	CuAl10Fe		CuAl10Fe	CA952		
				2.0975.01	CuAl10Ni		CuAl10Ni5Fe5	CA955		
				2.0872	CuNi10Fe1Mn		CuNi10Fe1Mn			
					CuNi10Zn45					
				2.0790	CuNi18Zn19Pb		CuNi18Zn19Pb1			
				2.1176	CuPb10Sn		CuSn10Pb10	CA937		
				2.1050.01	CuSn10		CuSn10			
				2.1087	CuSn10Zn					
				2.1020	CuSn6		CuSn6		C5191	
				2.0240	CuZn15		CuZn15		C2300	
				2.0470	CuZn28Sn1		CuZn29Sn1			
				2.0321	CuZn37		CuZn37			
				2.0530	CuZn38Sn1					
				2.0401	CuZn39Pb3		CuZn39Pb3			
2.0402	CuZn40Pb2		CuZn39Pb2							
2.0410	CuZn44Pb2									
Grey cast iron	K1	Grey cast irons (GCI)		0.6150	GG-15	G15	Ft 15 D	A48 25 B	FC 150	
				0.6200	GG-20	G20	Ft 20 D	A48 30 B	FC 200	
					GG-220 HB			G 3500		
				0.6250	GG-25	G25	Ft 25 D	A48 35 B	FC 250	
				0.6300	GG-30	G30	Ft 30 D	A48 45 B	FC 300	
				0.6350	GG-35	G35	Ft 35 D	A48 50 B	FC 350	
Ductile cast iron	K2	Ductile Cast Iron		0.7033	GGG-35.3		FGS 370-17		FCD 350-22L	
				0.7040	GGG-40	GS 400-12	FGS 400-12	60-40-18	FCD 400-18L	
				0.7043	GGG-40.3	GSO 42/17	FGS-370-17	60-40-18		
				0.7050	GGG-50	GS 500-7	FGS 500-7	A536 80-55-6	FCD 500-7	
				0.7060	GGG-60	GS 600-3	FGS 600-3	A476 80-60-03	FCD 600-3	
				0.7070	GGG-70	GS 700-2	FGS 700-2	A536 100-70-03	FCD 700-2	
Carbon steel	P1	Free-cutting steels	360 < Rm < 880	1.0715	9 SMn 28	CF 9 SMn 28	S 250	1213	SUM 22	
				1.0718	9 SMnPb 28	CF 9 SMnPb 28	S 250 Pb	12 L 13	SUM 22 L	
				1.0721	10 S 20	CF 10 S 20	10 F 1	1108		
				1.0722	10 SPb 20	CF 10 SPb 20	10 PbF 2	11 L 08		
				1.0723	15 S 20				SUM 32	
				1.0726	35 S 20		35 MF 4	1140		
				1.0727	46 S 20		45 MF 4	1146		
				1.0736	9 SMn 36	CF 9 SMn 36	S 300	1215		
				1.0737	9 SMnPb 36	CF 9 SMnPb 36	S 300 Pb	12 L 14		
				1.0037	St 37-2	Fe 360 B	E 24-2		STKM 12 C	
				1.0116	St 37-3	Fe 360 D FF	E 24-3, E 24-4	A 573 Gr. 58		
				1.0144	St 44-3 N	Fe 430 D FF	E 28-3, E 28-4	A 573 Gr. 70		SM 41 C
				1.0301	C 10	C 10	AF 34 C 10, XC 10	1010		S 10 C
				1.0401	C 15	C 15, C 16	AF 37 C 12, XC 18	1015		
				1.0402	C 22	C 20, C 21	C 20	1023		
		1.0570	St 52-3	Fe 510 B	E 36-3, E 36-4		SM 50 YA			
		1.1141	Ck 15	C 15, C 16	XC 15, XC 18	1015	S 15 C, S 15 CK			
		1.1158	Ck 25	C 25	XC 25	1025	S 25 C			
		"Ferritic & ferritic/pearlitic steels, C < 0.25%wt Weldable general structural steels Case hardening steels"	430 < Rm < 610	1.2162	21 MnCr 5		20 NC 5		SCR 420 H	
				1.5415	15 Mo 3	16 Mo 3	15 D 3	A 204 Gr. A		
				1.5423	16 Mo 5	16 Mo 5		4520	SB 450 M	
				1.5752	14 NiCr 14		12 NC 15	3310, 9314	SNC 815 (H)	
				1.5919	15 CrNi 6	16 CrNi4	16 NC 6	4320		
				1.6587	18 CrNiMo 7 6	18 NiCrMo 7	18 NCD 6			
				1.7131	16 MnCr 5	16 MnCr 5	16 MC 5	5115	SCR 415	
				1.7139	16 MnCrS 5					
				1.7147	20 MnCr 5	20 MnCr 5	20 MC 5	5120	SMnC 420 (H)	
				1.7149	20 MnCrS 5		20 MnCrS 5	5120 H	SMnC 21 H	
				1.7335	13 CrMo 4 4	14 CrMo 4 5	15 CD 3.5	A 182-F11, F12		
				1.7337	16 CrMo 4 4	14 CrMo 4 5	15 CD 4.5	A 387 Gr. 12 Cl. 2		
1.7380	10 CrMo 9 10			12 CrMo 9 10	10 CD 9.10	A 182-F22				

Material	HPMT	Description	Properties	W. Nr.	DIN	UNI	AFNOR	AISI/SAE/ASTM	JIS	Common Name		
Alloy steel	P2	"Low alloy general structural steels, 0.25% < C < 0.67%wt Low alloy Quench & Temper steels"	520 < Rm < 1200	1.0501	C 35	C 35	AF 55 C 35	1035				
				1.0503	C 45	C 45	AF 65 C 45	1045	S 45 C			
				1.0511	C 40	C 40	AF 60 C 40	1040	S 40 C			
				1.0535	St 70-2	Fe 690	A 70-2	1055				
				1.0601	C 60	C 60	CC 55	1060				
				1.1157	40 Mn 4		35 M 5	1039				
				1.1165	30 Mn 5			1330	SMn 1 H, SCMn 2			
				1.1167	36 Mn 5		40 M 5	1335	SMn 438 (H), SCMn 3			
				1.1181	Ck 35	C 35	XC 38 Hl	1035	S 35 C			
				1.1191	Ck 45	C 45	XC 42	1045	S 45 C			
				1.1221	Ck 60	C 60	XC 60	1064	S 58 C			
				1.1740	C 60 W		Y3 55	1060	SK 7			
				1.0904	55 Si 7	55 Si 8	55 S 7	9255				
				1.1201	42 CrMo 4	42 CrMo 4	42 CD 4	4142, 4140	SCM 440 (H)			
				1.1201	42 CrMo 4	42 CrMo 4	42 CD 4	4142, 4140	SCM 440 (H)			
				1.2330	35 CrMo 4	35 CrMo 4	34 CD 4	4135				
		1.2542	45 WCrV 7	45 WCrV 8 KU		S1						
		1.2714	56 NiCrMoV 7	56 NiCrMoV7-KU		L6	SKT 4					
		1.5121	46 MnSi 4			5045						
		1.5710	36 NiCr 6		35 NC 6	3135	SNC 236					
		1.5736	36 NiCr 10	35 NiCr 9	35 NC 11	3435	SNC 631 (H)					
		1.6511	36 CrNiMo 4	38 NiCrMo 4 (KB)	40 NCD 3	9840						
		1.6582	36 CrNiMo 6	35 NiCrMo 6 (KW)	35 NCD 6	4340	SNCM 447					
		1.7033	34 Cr 4	34 Cr 4 (KB)	32 C 4	5132	SCr 430 (H)					
		1.7035	41 Cr 4	41 Cr 4	42 C 4	5140	SCr 440 (H)					
		1.7218	25 CrMo 4	25 CrMo 4 (KB)	25 CD 4 S	4130	SCM 425					
		1.7361	32 CrMo 12	32 CrMo 12	30 CD 12							
		1.8159	50 CrV 4	51 CrV 4	50 CV 4	6150	SUP 10					
		1.8509	41 CrAlMo 7	41 CrAlMo 7	40 CAD 6:12	A 355 Cl. A	SACM 645					
		1.1231	Ck 67	C 70	XC 68	1070						
		1.1274	Ck 101			1095	SUP 4					
		1.1545	C 105 W1	C 100 KU	Y1 105	W1						
1.1645	C 105 W2	C 100 KU	Y1 105		SK 3							
1.1663	C 125 W	C 120 KU	Y2 120	W1	SK 2							
1.2210	115 CrV 3	107 CrV 3 KU	100 C 3	L2								
1.2510	100 MnCrW 4	95 MnWCr 5 KU	90 MWCV 5	O1	SKS 3							
1.2842	90 MnCrV 8	90 MnVCr 8 KU	90 MV 8	O2								
1.3505	100 Cr 6	100 Cr 6	100 C 6	52100	SUJ 2							
Prehardened steel	P3	"Low alloy through hardening steels, C > 0.67%wt Low alloy spring and bearing steels"	35 ≤ HRC < 45	1.2080	X 210 Cr 12	X 210 Cr 13 KU	Z 200 C 12	D3	SKD 1			
				1.2343	X 38 CrMoV 5 1	X 37 CrMoV 5 1 KU	Z 38 CDV 5	H11	SKD 6			
				1.2344	X 40 CrMoV 5 1	X 40 CrMo 5 11 KU	Z 40 CDV 5	H13	SKD 61			
				1.2363	X 100 CrMoV 5 1	X 100 CrMoV 5 1 KU	Z 100 CDV 5	A2	SKD 12			
				1.2365	X 32 CrMoV 3 3	30 CrMoV 12 27 KU	32 DCV 28	H10	SKD 7			
				1.2436	X 210 CrW 12	X 215 CrW 12 1 KU			SKD 2			
				1.2601	X 165 CrMoV 12	X 165 CrMoW 12 KU						
				1.2713	55 NiCrMoV 6		55 NCDV 7	L6	SKT 4			
		1.3243	S 6-5-2-5	HS 6-5-2-5	Z 85 WDKCV 06-05-05-04-02	M35	SKH 55					
		1.3247	S 2-10-1-8	HS 2-9-1-8	Z 110 DKCWV 09-08-04	M42	SKH 51					
		1.3255	S 18-1-2-5	HS 18-1-1-5	Z 80 WKCV 18-05-04-01	T4	SKH 3					
		1.3343	S 6-5-2	HS 6-5-2	Z 85 WDCV 06-05-04-02	M2	SKH 9, SKH 51					
		1.3348	S 2-9-2	HS 2-9-2	Z 100 DCWV 09-04-02-02	M7	SKH 58					
		1.3355	S 18-0-1	HS 18-0-1	Z 80 WCV 18-04-01	T1	SKH 2					
		Prehardened steel	P3	"Tool steels High speed steels (HSS)"	35 ≤ HRC < 45	1.2080	X 210 Cr 12	X 210 Cr 13 KU	Z 200 C 12	D3	SKD 1	
						1.2343	X 38 CrMoV 5 1	X 37 CrMoV 5 1 KU	Z 38 CDV 5	H11	SKD 6	
1.2344	X 40 CrMoV 5 1					X 40 CrMo 5 11 KU	Z 40 CDV 5	H13	SKD 61			
1.2363	X 100 CrMoV 5 1					X 100 CrMoV 5 1 KU	Z 100 CDV 5	A2	SKD 12			
1.2365	X 32 CrMoV 3 3					30 CrMoV 12 27 KU	32 DCV 28	H10	SKD 7			
1.2436	X 210 CrW 12					X 215 CrW 12 1 KU			SKD 2			
1.2601	X 165 CrMoV 12					X 165 CrMoW 12 KU						
1.2713	55 NiCrMoV 6						55 NCDV 7	L6	SKT 4			
1.3243	S 6-5-2-5					HS 6-5-2-5	Z 85 WDKCV 06-05-05-04-02	M35	SKH 55			
1.3247	S 2-10-1-8					HS 2-9-1-8	Z 110 DKCWV 09-08-04	M42	SKH 51			
1.3255	S 18-1-2-5					HS 18-1-1-5	Z 80 WKCV 18-05-04-01	T4	SKH 3			
1.3343	S 6-5-2					HS 6-5-2	Z 85 WDCV 06-05-04-02	M2	SKH 9, SKH 51			
1.3348	S 2-9-2					HS 2-9-2	Z 100 DCWV 09-04-02-02	M7	SKH 58			
1.3355	S 18-0-1					HS 18-0-1	Z 80 WCV 18-04-01	T1	SKH 2			

Material	HPMT	Description	Properties	W. Nr.	DIN	UNI	AFNOR	AISI/SAE/ASTM	JIS	Common Name		
Stainless steel, high machinability	M1	Free-cutting austenitic stainless steel		1.4305	X 10 CrNiS 18 9	X 10 CrNi 18 09	Z 10 CNF 18.09	303	SUS 303			
		Low alloy austenitic stainless steels		1.4300	X 12 CrNi 18 8		Z 12 CN 18	302	SUS 302			
				1.4301	X 6 CrNi 18 10	X 5 CrNi 18 11	Z 6 CN 18.09	304	SUS 304			
				1.4306	X 2 CrNi 19 11	X 3 CrNi 18 11	Z 2 CN 18.10	304 L	SUS 304 L			
				1.4310	X 12 CrNi 17 7	X 12 CrNi 17.07	Z 12 CN 17.07	301	SUS 301			
				1.4401	X 5 CrNiMo 17 12 2	X 5 CrNiMo 17 12	Z 3 CND 17.11	316	s			
		Medium alloy austenitic stainless steels		1.4550	X 6 CrNiNb 18 10	X 6 CrNiNb 18 11	Z 6 CNNb 18.10	347	SUS 347			
				1.4311	X 2 CrNiN 19 11	X 2 CrNiN 18 11	Z 2 CN 18.10 Az	304 LN	SUS 304 LN			
				1.4335	X 12 CrNi 25 21	X 6 CrNi 26 20	Z 12 CN 25.20	310 S	SUH 310, SUS 310 S			
				1.4429	X 2 CrNiMoN 17 13 3	X 2 CrNiMoN 17 13 3	Z 2 CND 17.13 Az	316 LN	SUS 316 LN			
				1.4435	X 2 CrNiMo 18 14 3	X 2 CrNiMo 17 13 2	Z 2 CND 17.13	316L	SCS 16, SUS 316L			
			1.4466	X 5 CrNi 18 15	X 5 CrNi 18 15		317	SUS 317				
			1.4893	X 9 CrNiSiN 21 11 2						252 MA		
		Stainless steel, low machinability	M2	Ferritic & martensitic stainless steels		1.4000	X 6 Cr 13	X 6 Cr 13	Z 6 C 12	403	SUS 403	
						1.4006	X 10 Cr 13	X 12 Cr 13	Z 10 C 13	410, CA-15	SUS 410	
	1.4016				X 6 Cr 17	X 8 Cr 17	Z 8 C 17	430	SUS 430			
	1.4021				X 20 Cr 13	X 20 Cr 13	Z 20 C 13	420	SUS 420 J 1			
	1.4031				X 40 Cr 13	X 40 Cr 14	Z 40 C 14	420	SUS 420			
	1.4109				X 65 CrMo 14		Z 70 D 14	440 A	SUS 440 A			
	1.4112				X 90 CrMoV 18	X CrTi 12	Z 2 CND 18 05	440 B	SUS 440 B			
	1.4125				X 105 CrMo 17	X 105 CrMo 17	Z 100 CD 17	440 C	SUS 440 C			
	1.4313				X 5 CrNi 13 4	X 6 CrNi 13 04	Z 5 CN 13.4		SCS 5			
	1.4749				X 18 CrN 28		Z 18 C 25	446				
High alloy austenitic and duplex stainless steels				1.4417	X 2 CrNiMoSi 19 5		Z 2 CND 18.05.03			3RE60		
				1.4460	X 4 CrNiMo 27 5 2	X 3 CrNiMo 27 5 2	Z 3 CND 25.7 Az	329	SUS 329 J 1			
				1.4462	X 2 CrNiMoN 22 5	X 2 CrNiMoN 22 5	Z 2 CND 22.05 Az	329 LN		SAF 2205		
				1.4539	X 2 NiCrMoCu 25 20 5		Z 2 NCDU 25 20	904L				
				1.4410	X 2 CrNiMoN 25 7 4	X 2 CrNiMoN 25 7 4	Z 3 CND 25.07 Az	F 53		SAF 2507		
Difficult high alloy austenitic and duplex stainless steels				1.4529	X 1 CrNiMoN 20 18 7	X 1 CrNiMoN 20 18 7	Z 1 CNDU 20.18.05 Az			254 SMO		
				1.4534	X 3 CrNiMoAl 13 8 2				XM-13	PH13-8Mo		
				1.4540	X 4 CrNiCuNb 16 4			Z 4 CNUNb 16.4 M	XM-12	15-5-PH		
				1.4568	X 7 CrNiAl 17 7	X 7 CrNiAl 17 7	Z 9 CAN 17.7	AMS 5528	SUS 631	17-7-PH		
				1.4652	X 2 CrNiMoN 25 22 7					654 SMO		
		1.4876	X 10 NiCrAlTi 32 20			Z 10 NC 32.21		NCF 800	Alloy 800			
		1.4943	X 4 NiCrTi 25 15			Z 6 NCTDV 25.15	660	SUH 660	A286			
Titanium alloy	S1	Titanium, low alloyed, (α)		3.7024						Ti		
		Titanium, medium alloyed, (α+β)					AMS 4919		Ti 6-2-4-2			
		Titanium, high alloyed		3.7164	TiV10Fe2Al3			AMS 4943		Ti 3Al-2.5V (grade 9)		
Nickel alloy	S2	Nickel based super-alloys		2.4810				AMS 4920, Grade 5		Ti 6Al-4V		
				2.4819				AMS 4986		Ti 10V-2Fe-3Al		
				2.4668						Hastelloy C		
				2.4669						Hastelloy C-276		
				2.4631						IN 100		
				2.4654						Inconel 718		
										Inconel X-750		
Cobalt alloy	S3	Cobalt based super-alloys								Nimonic 80A		
										René 41		
									Udimet 500			
									Waspalloy			
									Haynes 25			
									Stellite 21			
									Stellite 31			

Material	HPMT	Description	Properties	W. Nr.	DIN	UNI	AFNOR	AISI/SAE/ASTM	JIS	Common Name	
Hardened steel	H1 & H2	Case hardened steels	58 < HRC < 62	1.7131	16 MnCr 5	16 MnCr 5	16 MC 5	5115	SCR 415		
		Quenched & Tempered steels	38 < HRC < 56	1.1201	42 CrMo 4	42 CrMo 4	42 CD 4	4142, 4140	SCM 440 (H)		
				1.1231	Ck 67	C 70	XC 68	1070			
				1.1248	Ck 75	C 75	XC 75	1078, 1080			
				1.1274	Ck 101			1095	SUP 4		
				1.1545	C 105 W1	C 100 KU	Y1 105	W 1			
				1.2550	60 WCrV 7	55 WCrV 8 KU	55 WC 20	S1			
				1.7176	55 Cr 3	55 Cr 3	55 C 3	5155	SUP 9 (A)		
		Quenched & Tempered steels Bearing Steels	56 < HRC < 64	1.2210	115 CrV 3	107 CrV 3 KU	100 C 3	L2			
				1.2510	100 MnCrW 4	95 MnWCr 5 KU	90 MWCV 5	O1	SKS 3		
				1.2842	90 MnCrV 8	90 MnVCr 8 KU	90 MV 8	O2			
				1.3505	100 Cr 6	100 Cr 6	100 C 6	52100	SUJ 2		
		"Tool steels High Speed Steels"	38 < HRC < 64	1.2344	X 40 CrMoV 5 1	X 40 CrMo 5 11 KU	Z 40 CDV 5	H13	SKD 61		
				1.2363	X 100 CrMoV 5 1	X 100 CrMoV 5 1 KU	Z 100 CDV 5	A2	SKD 12		
				1.2379	X 155 CrVMo 12 1	X 155 CrVMo 12 1 KU	Z 160 CDV 12	D2	SKD 11		
				1.2436	X 210 CrW 12	X 215 CrW 12 1 KU			SKD 2		
				1.2601	X 165 CrMoV 12	X 165 CrMoW 12 KU					
				1.2713	55 CNiCrMoV6		55 NCDV 7	L6	SKT 4		
				1.3243	S 6-5-2-5	HS 6-5-2-5	Z 85 WDKCV 06-05-05-04-02	M35	SKH 55		
				1.3247	S 2-10-1-8	HS 2-9-1-8	Z 110 DKCWV 09-08-04	M42	SKH 51		
				1.3343	S 6-5-2	HS 6-5-2	Z 85 WDCV 06-05-04-0	M2	SKH 9, SKH 51		
				1.3355	S 18-0-1	HS 18-0-1	Z 80 WCV 18-04-01	T1	SKH 2		
		Martensitic stainless steels	38 < HRC < 50	1.4021	X 20 Cr 13	X 20 Cr 13	Z 20 C 13	420	SUS 420 J 1		
				1.4109	X 65 CrMo 14		Z 70 D 14	440 A	SUS 440 A		
				1.4112	X 90 CrMoV 18	X CrTi 12	Z 2 CND 18 05	440 B	SUS 440 B		
				1.4125	X 105 CrMo 17	X 105 CrMo 17	Z 100 CD 17	440 C	SUS 440 C		
				1.4534	X 3 CrNiMoAl 13 8 2			XM-13		PH13-8Mo	
		Precipitation hardened stainless steels	33 < HRC < 50	1.4542	X 5 CrNiCuNb 17 4		Z 6 CNU 17.4	630	SCS 24, SUS 630	17-4-PH	
				1.4568	X 7 CrNiAl 17 7	X 7 CrNiAl 17 7	Z 9 CAN 17.4	AMS 5528	SUS 631	17-7-PH	
				1.4943	X 4 NiCrTi 25 15		Z 6 NCTDV 25.15	660	SUH 660	A286	
		Manganese steels	23 < HRC < 64	1.3401	X 120 Mn 12		Z 120 M 12	A128 Grade A	SC MnH 1		
		White Cast Irons	50 < HRC < 64	G-X330 NiCr 4 2	FB Ni4 Cr2 BC		Grade 2 A	A532 IB(NiCr-LC)		Ni-Hard 2	
				G-X260 NiCr4 2	FB Ni4 Cr2 HC		Grade 2 B	A532 IA (NiCr-HC)		Ni-Hard 1	
				G-X300 CrNiSi 9 5 2	FB Cr9 Ni5		Grade 2 C, D, E	A532 ID (Ni-HiCr)		Ni-Hard 4	
		Thermoplastics	O1								
		Graphite	O2								

Hardness Conversion Chart



Tensile Strength Rm in N/mm ²	Brinell Hardness HB	Rockwell Hardness HRC	Vickers Hardness HV	PSI
150	50		50	22
200	60		60	29
250	80		80	37
300	90		95	43
350	100		110	50
400	120		125	58
450	130		140	66
500	150		155	73
550	165		170	79
600	175		185	85
650	190		200	92
700	200		220	98
750	215		235	105
800	230	22	250	112
850	250	25	265	120
900	270	27	280	128
950	280	29	295	135
1000	300	31	310	143
1050	310	33	325	150
1100	320	34	340	158
1150	340	36	360	164
1200	350	38	375	170
1250	370	40	390	177
1300	380	41	405	185
1350	400	43	420	192
1400	410	44	435	200
1450	430	45	450	207
1500	440	46	465	214
1550	450	48	480	221
1600	470	49	495	228
		51	530	247
		53	560	265
		55	595	283
		57	635	301
		59	680	320
		61	720	338
		63	770	357
		64	800	365
		65	830	373
		66	870	382
		67	900	391
		68	940	400
		69	980	409

Certificate

Standard **ISO 9001:2015**

Certificate Registr. No. **01 100 053515**

Certificate Holder:



HPMT Industries Sdn. Bhd.

No. 5, Jalan Sungai Kayu Ara 32/39, Taman Berjaya,
Seksyen 32, Shah Alam, Selangor Darul Ehsan, Malaysia

Scope: Manufacturing of Standard and Custom-made Metal Removing
Cutting Tools

Proof has been furnished by means of an audit that the
requirements of ISO 9001:2015 are met.

Validity: The certificate is valid from 2021-08-15 until 2022-02-14.
First certification 2005

2021-08-16

TÜV Rheinland Cert GmbH
Am Grauen Stein · 51105 Köln

© TÜV, TÜEV and TUV are registered trademarks. Utilisation and application requires prior approval.

www.tuv.com





HPMT
High Precision Machining Tools



hpmt-industries.com/



[linkedin.com/company/hpmt-industries-sdn-bhd](https://www.linkedin.com/company/hpmt-industries-sdn-bhd)



[facebook.com/HighPrecisionMachiningTools](https://www.facebook.com/HighPrecisionMachiningTools)

HPMT INDUSTRIES SDN BHD

5 Jalan Sungai Kayu Ara 32/39
Taman Berjaya, Seksyen 32
40460 Shah Alam,
Selangor Darul Ehsan, Malaysia
T + 603 5740 2218
F + 603 5740 2238
E info@hpmt-industries.com
W www.hpmt-industries.com

HPMT (SHEN ZHEN) LTD

1223, Kerry Centre
2008 Renminnan Road
ShenZhen China
T 00755 2518 1722
F 00755 2518 1728
E info@hpmt-industries.cn
W www.hpmt-industries.cn

HERROZ SDN BHD

5 Jalan Sungai Kayu Ara 32/39
Taman Berjaya, Seksyen 32
40460 Shah Alam,
Selangor Darul Ehsan, Malaysia
T + 603 5740 2838 (Selangor)
+ 607 351 9910 (Johor)
F + 603 5740 2822 (Selangor)
+ 603 5740 2823 (Selangor)
+ 607 355 2461 (Johor)
E info@herroz.com
W www.herroz.com

HPMT DEUTSCHLAND GMBH

Vorkamp 6, D-23879 Molln
T + 49 (0) 45 42 / 84 21 10
F + 49 (0) 45 42 / 84 21 08
E info@hpmt-deutschland.de
W www.hpmt-deutschland.de

MTC TOOLING SYSTEMS LTD

204-5 Fook Hong Ind Bldg
19 Shueng Yuet Road
Kowloon Bay, Hong Kong
T 00852 2305 4838
F 00852 2798 8789
E info@mtc-tools.com